

HURRICANE™ 1800 FLEX

User Manual



CHAUVET®
Value • Innovation • Performance

TABLE OF CONTENTS

1. BEFORE YOU BEGIN.....	3
WHAT IS INCLUDED	3
UNPACKING INSTRUCTIONS	3
CLAIMS	3
TEXT CONVENTIONS.....	3
ICONS.....	3
SAFETY NOTES	4
2. INTRODUCTION.....	5
PRODUCT OVERVIEW	5
3. SETUP.....	5
AC POWER.....	6
BREAKER RESET	6
PRODUCT LINKING	6
Data Cabling	7
DMX Data Cable	7
Cable Connectors.....	7
3-Pin to 5-Pin Conversion Chart.....	8
SETTING UP A DMX SERIAL DATA LINK	8
MASTER/SLAVE PRODUCT LINKING	8
MOUNTING.....	9
Orientation	9
Rigging	9
4. OPERATION.....	10
DMX CHANNEL SUMMARY	10
DMX MODE.....	10
DMX CHANNEL VALUES	10
Auto Cut-Off Feature	10
Wireless Controller (FC-W) (Optional).....	11
Setting the Starting Address.....	12
DMX Quick Reference Chart	13
5. TECHNICAL INFORMATION.....	14
GENERAL MAINTENANCE.....	14
STORAGE	14
GENERAL TROUBLESHOOTING.....	15
CONTACT INFORMATION.....	15
RETURNS PROCEDURE	16
6. APPENDIX.....	17
DMX PRIMER.....	17
TECHNICAL SPECIFICATIONS.....	18

The information and specifications contained in this document are subject to change without notice. CHAUVET® assumes no responsibility or liability for any errors or omissions that may appear in this manual.

© Copyright 2013 CHAUVET®. All rights reserved

Printed in P.R.C.

Electronically published by CHAUVET® in the United States of America

1. BEFORE YOU BEGIN

What Is Included

- 1 x Hurricane™ 1800 Flex
- Power Cord
- FC-T Wired Remote
- Warranty Card
- Quick Reference Guide

Unpacking Instructions

Immediately upon receiving this product, carefully unpack it and check the container in which you received it. Make sure that you have received all the parts indicated above and that they are all in good condition. If the material inside the container (this product and any other accessory included with it) appears damaged from shipping, or if the container shows signs of mishandling, notify the shipper immediately. In addition, retain the container and all the packing material for inspection.

See the *Claims* section in the “*Technical Information*” chapter.

Claims



The carrier is responsible for any damage incurred during shipping to this product or any part that shipped with it. Therefore, if the received merchandise appears to have damages caused during shipping, the customer must submit the damage report and any related claims with the carrier, not CHAUVET®. The customer must submit the report upon reception of the damaged merchandise. Failure to do so in a timely manner may invalidate the customer’s claim with the carrier.

For other issues such as missing components or parts, damage not related to shipping, or concealed damage, the customer must make claims to CHAUVET® within seven (7) days of receiving the merchandise.

Text Conventions

Convention	Meaning
[10]	A DIP switch to be configured
<Menu>	A key to be pressed on the product’s control panel
1~512	A range of values
50/60	A set of values of which only one can be chosen
Settings	A menu option not to be modified (for example, showing the operating mode/current status)
Menu > Settings	A sequence of menu options to be followed
ON	A value to be entered or selected

Icons

Icon	Meaning
	This paragraph contains critical installation, configuration, or operation information. Failure to comply with this information may render the product partially or completely inoperative, cause damage to the product, or cause harm to the user.
	This paragraph contains important installation or configuration information. Failure to comply with this information may prevent the product from functioning correctly.



This paragraph reminds you of useful, although not critical, information.

Product at a Glance

Use on Dimmer	X	Auto Programs	X
Outdoor Use	X	Auto-ranging Power Supply	X
Sound Activated	X	Resettable Breaker	P
DMX	P	User Serviceable	X
Master/Slave	X	Duty Cycle	X

Safety Notes



Please read the following notes carefully because they include important safety information about the installation, usage, and maintenance of this product.

There are no user serviceable parts inside the unit. Do not open the housing or attempt any repairs yourself. In the unlikely event your unit may require service, please contact CHAUVET® at: 954-577-4455.

- Keep this User Manual for future consultation. If you sell this product to another user, be sure that they also receive this document.
- Always make sure that the voltage of the outlet to which you are connecting this product is within the range stated on the decal or rear panel of the product.
- This product is for indoor use only! To prevent risk of fire or shock, do not expose this product to rain or moisture.
- Make sure there are no flammable materials close to the unit while operating.
- Always install this product in a location with adequate ventilation, at least 20 in (50 cm) from adjacent surfaces.
- Be sure that no ventilation slots on the unit's housing are blocked.
- Always disconnect this product from the power source before cleaning it or replacing the fuse.
- Make sure to replace the fuse with another of the same type and rating.
- If mounting this product overhead, always secure it to a fastening device using a safety cable.
- The maximum ambient temperature (Ta) is 104° F (40° C). Do not operate this product at higher temperatures.
- In the event of a serious operating problem, stop using the unit immediately.
- Never try to repair this product. Repairs carried out by unskilled people can lead to damage or malfunction. Please contact the nearest authorized technical assistance center.
- Never connect this product to a dimmer pack.
- Make sure the power cord is not crimped or damaged.
- Never disconnect the power cord by pulling or tugging on the cord.
- Never carry a product from the power cord or any moving part. Always use the hanging/mounting bracket or the handles.
- Do not touch the output nozzle on this product. It is very hot during operation and it may remain hot for several hours after turning the unit off.
- Do not mount this product on a flammable surface (e.g., wood, linoleum, carton, plastic, or carpet).
- Make sure there are no flammable materials close to the unit while operating.
- Depending on the amount of fog generated, all fog machines may set off smoke detectors.
- Do not use as a space heater.



FCQ (Fog Cleaner Quart) was specifically developed by Chauvet to clean your Hurricane™ 1800 Flex. Make sure you use FCQ regularly to increase the life of your fogger.

2. INTRODUCTION

Product Overview

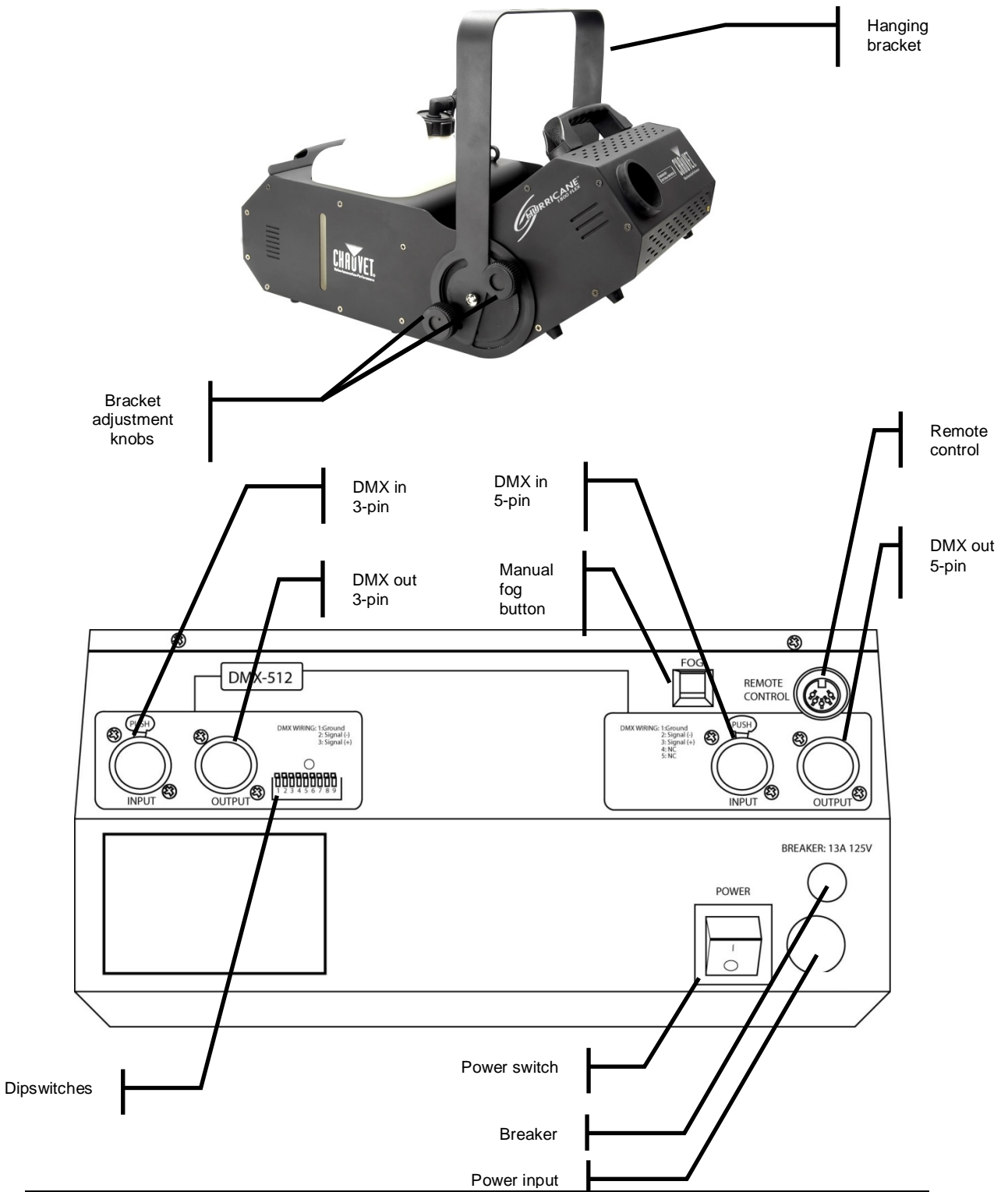

3. SETUP

AC Power

To determine the power requirements for a particular product, see the label affixed to the back plate of the product or refer to the product's specifications chart. A product's listed current rating is its average current draw under normal conditions. All products must be powered directly off a switched circuit and cannot be run off a rheostat (variable resistor) or dimmer circuit, even if the rheostat or dimmer channel is used solely for a 0% to 100% switch. Before applying power to a product, check that the source voltage matches the product's requirement. Check the product or device carefully to make sure that if a voltage selection switch exists that it is set to the correct line voltage you will use.



Verify that the voltage rating on your unit matches the line voltage applied. Damage to your product may result if the line voltage applied does not match the voltage rating. All products must be connected to circuits with a suitable earth ground.

Breaker Reset



Disconnect the power cord before resetting the breaker.

The breaker will not reset until it has been allowed to cool.

This product is equipped with a breaker on the main power input, located on the exterior of the back panel. In the event that this breaker trips, you may reset it very easily.

1. Unplug the product from the mains power.
2. Allow to cool for 5-15 minutes.
3. Using your hand, press on the button for the breaker, until it remains in place.



In the event this breaker will not reset, contact CHAUVET® for troubleshooting. The product may need to be serviced.

Product Linking

You will need a serial data link to run light shows of one or more products using a DMX-512 controller or to run synchronized shows on two or more products set to a master/slave operating mode. The combined number of channels required by all the products on a serial data link determines the number of products the data link can support.



Products on a serial data link must be daisy chained in one single line. To comply with the EIA-485 standard no more than 32 devices should be connected on one data link. Connecting more than 32 products on one serial data link without the use of a DMX optically-isolated splitter may result in deterioration of the digital DMX signal.

- Maximum recommended serial data link distance: 500 meters (1640 ft.)
- Maximum recommended number of products on a serial data link: 32 products

Data Cabling

To link products together you must obtain data cables. You can purchase CHAUVET® certified DMX cables directly from a dealer/distributor or construct your own cable. If you choose to create your own cable please use data-grade cables that can carry a high quality signal and are less prone to electromagnetic interference.

DMX Data Cable

Use a Belden® 9841 or equivalent cable which meets the specifications for EIA RS-485 applications. Standard microphone cables cannot transmit DMX data reliably over long distances. The cable will have the following characteristics:

- 2-conductor twisted pair plus a shield
- Maximum capacitance between conductors – 30 pF/ft.
- Maximum capacitance between conductor and shield – 55 pF/ft.
- Maximum resistance of 20 ohms / 1000 ft.
- Nominal impedance 100 – 140 ohms

Cable Connectors

Cabling must have a male XLR connector on one end and a female XLR connector on the other end.

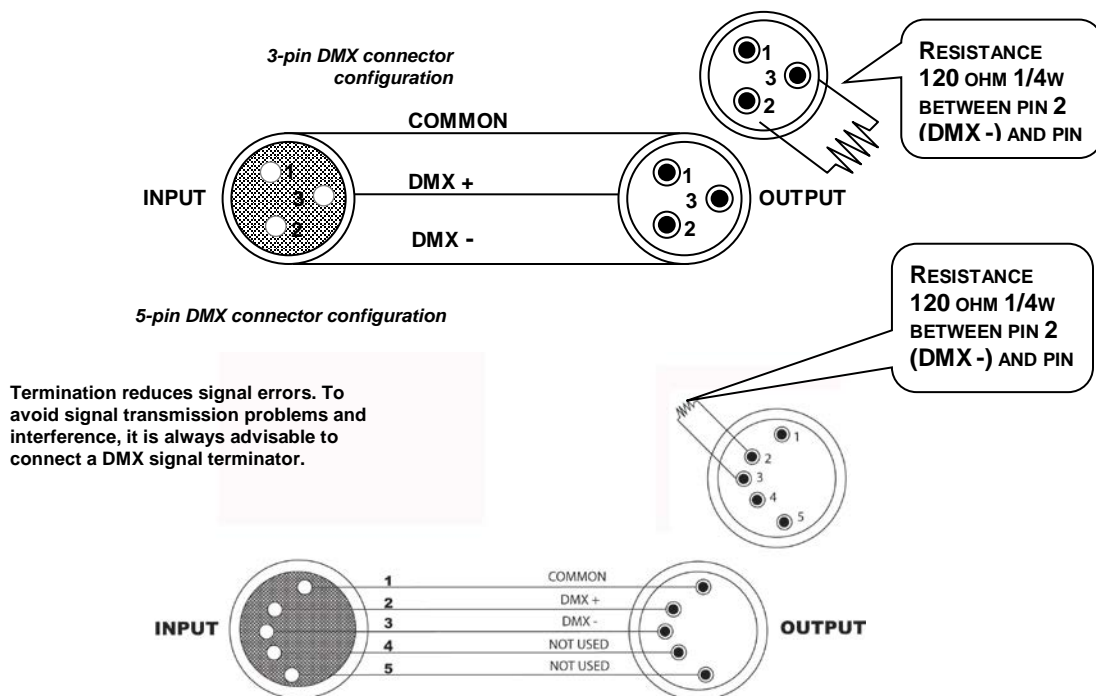

Do not allow contact between the common and the product's chassis ground. Grounding the common can cause a ground loop, and your product may perform erratically. Test cables with an ohm meter to verify correct polarity and to make sure the pins are not grounded or shorted to the shield or each other.

3-Pin to 5-Pin Conversion Chart



If you use a controller with a 5 pin DMX output connector, you will need to use a 5 pin to 3 pin adapter.

The chart below details a proper cable conversion:

3 PIN TO 5 PIN CONVERSION CHART

Conductor	3 Pin Female (output)	5 Pin Male (Input)
Ground/Shield	Pin 1	Pin 1
Data (-) signal	Pin 2	Pin 2
Data (+) signal	Pin 3	Pin 3
Not Used		Pin 4
Not Used		Pin 5

Setting up a DMX Serial Data Link

1. Connect the (male) 3 pin connector side of the DMX cable to the output (female) 3 pin connector of the controller.
2. Connect the end of the cable coming from the controller which will have a (female) 3 pin connector to the input connector of the next product consisting of a (male) 3 pin connector.
3. Then, proceed to connect from the output as stated above to the input of the following product and so on.

Universal DMX Controller

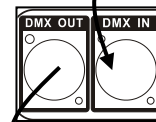
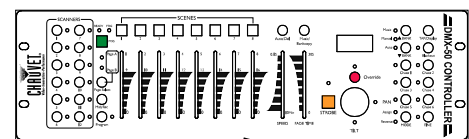

This drawing provides a general illustration of the DMX Input/Output panel of a lighting product.

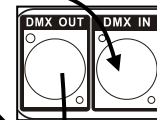

Continue the link

Master/Slave Product Linking

1. Connect the (male) 3 pin connector side of the DMX cable to the output (female) 3 pin connector of the first product.
2. Connect the end of the cable coming from the first product which will have a (female) 3 pin connector to the input connector of the next product consisting of a (male) 3 pin connector. Then, proceed to connect from the output as stated above to the input of the following product and so on.

Often, the setup for Master-Slave and Standalone operation requires that the first product in the chain be initialized for this purpose via DIP switches. Secondly, the products that follow may also require a slave setting. Please consult the "Operating Instructions" section in this manual for complete instructions for this type of setup and configuration.

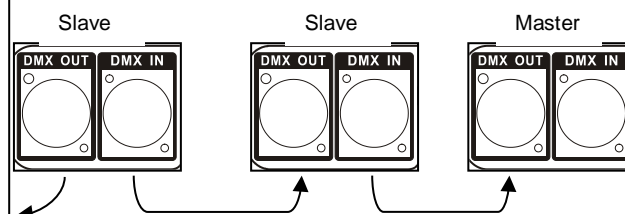

Mounting

Orientation

This product may be mounted in a 90° degree angle (horizontal), provided there is adequate room for ventilation. The tank of the product should not move from this position. However, the front portion of the fog machine can tilt up and down in the desired direction. This is secured by using the bracket adjustment knobs.

Rigging

It is important never to obstruct the fan or vents pathway. Mount the product using a suitable "C" or "O" type clamp. Adjust the angle of the product by loosening both knobs and tilting the product. After finding the desired position, retighten both knobs.

- When selecting installation location, take into consideration fluid tank access and routine maintenance.
- Safety cables must always be used.
- Never mount in places where the product will be exposed to rain, high humidity, extreme temperature changes, or restricted ventilation.

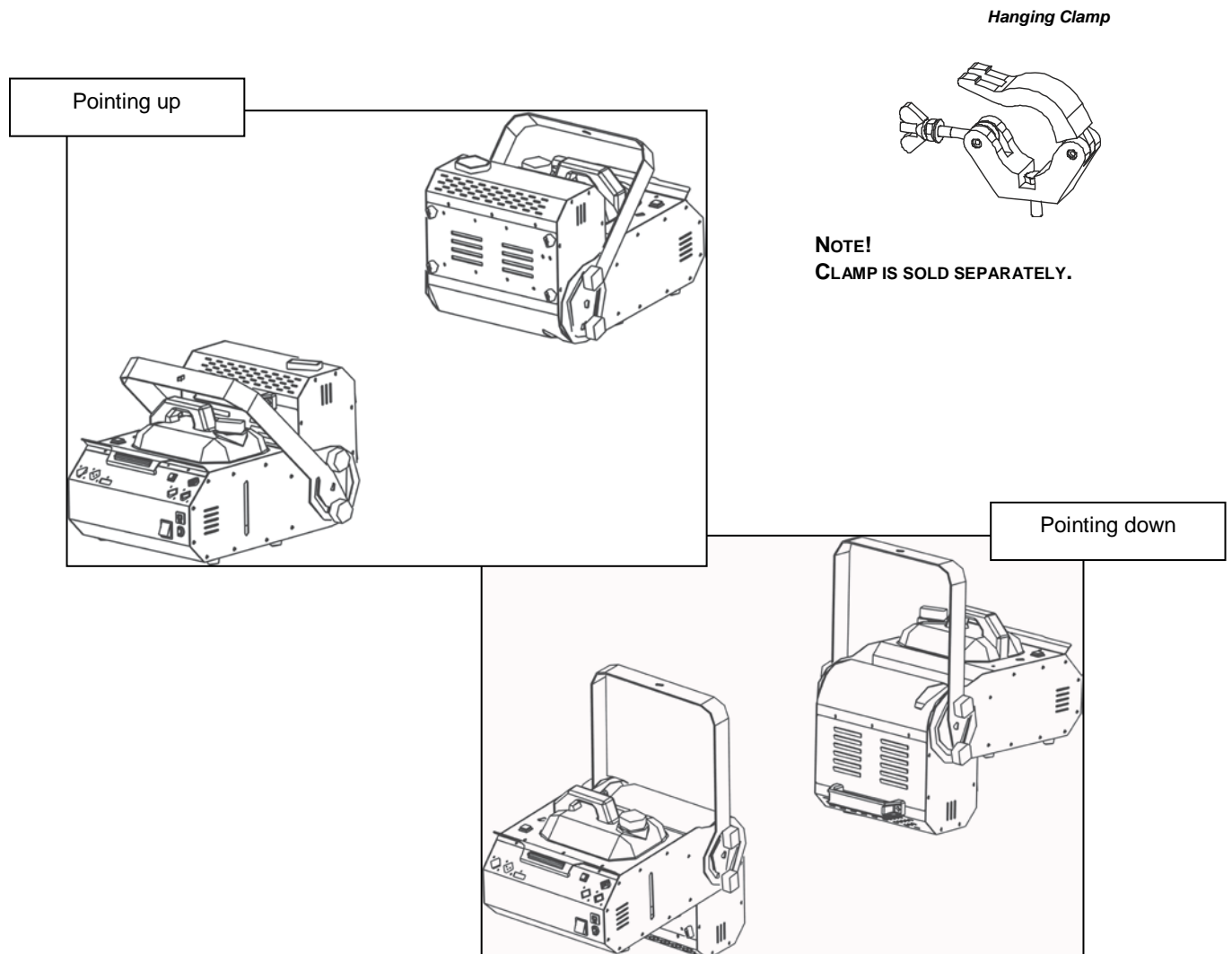

4. OPERATION

DMX Channel Summary

CHANNEL	FUNCTION
1	Fog output

DMX Mode

This mode allows the unit to be controlled by any universal DMX controller. If you are unfamiliar with DMX, please read the DMX Primer in the Appendix of this manual.

1. This product will automatically switch to DMX mode operation, once a DMX controller has been plugged into the 3-pin or 5-pin DMX input.
2. Use DIP switches 1~9 to set the DMX address.

DMX Channel Values

CHANNEL	VALUE	FUNCTION
1	000	Fog output
	005	No function
	006 - 255	Fog output 0%~100%

Auto Cut-Off Feature

This product has an auto cut-off safety feature to keep the machine from becoming damaged. This is referring to the operation of the pump. When the fluid tank is empty, the pump will still operate for a short period of time, until all of the fluid has been removed from the system. Then, it will sense that there is no fluid, and will automatically stop the fog output. An indication that this has occurred is when the blue LED's that are lighting the fluid tank are flashing.

- This feature takes approximately 30 seconds to 1 minute to engage once the fluid has emptied from the tank.



- In order for the fog machine to automatically reset, the trigger must be released either from the wired remote, wireless remote, the manual fog button on the unit, or via a DMX controller. If the DMX controller is used, the DMX channel must be brought to a value of 000 (0%) in order to allow the fog machine to reset itself.
- Once the tank has been refilled with fog fluid, you may resume using the fog machine. The auto cut-off will automatically reset.

Wireless Controller (FC-W) (Optional)

This mode will allow you to control the fogger using the optional wireless controller. This consists of the transmitter and the receiver. You may control up to 4 independent fog machines or many more if you run them simultaneously. See the below instructions on setting up your fogger to operate with the FC-W.

1. Plug the wires receiver into the fog machine 5-pin port labeled "Remote Control".
2. There are 4 buttons on the wireless remote transmitter which act as triggers. Each button can be assigned to a different fog machine. You may only choose 1 dipswitch on each receiver. See the below configuration for setting the receivers to operate with the transmitter remote.

Mode	DIP Switches
CH1	1 = On, 2-4 = Off
CH2	2 = On, 1,3,4 = Off
CH3	3 = On, 1,2,4 = Off
CH4	4 = On, 1,2,3 = Off

3. Press the fog button, and the fog machine will output fog for as long as you hold down the button.



Setting the Starting Address

This DMX mode enables the use of a universal DMX controller device. Each product requires a "start address" from 1 to 512. A product requiring one or more channels for control begins to read the data on the channel indicated by the start address. For example, a product that uses 6 DMX channels and was addressed to start on DMX channel 100, would read data from channels: 100, 101, 102, 103, 104, and 105. Choose start addresses so that the channels used do not overlap, and note the start address selected for future reference.

If this is your first time addressing a product using the DMX-512 control protocol, we suggest jumping to the Appendix Section and reading the section *DMX Primer*. This section contains very useful information that will help you understand DMX use.

Set the start address using the group of DIP switches located usually on bottom of the product. Each dip switch has an associated value. Adding the value of each switch in the ON position will provide the start address. Figuring out which switches to toggle ON given a specific start address can be accomplished by determining which switch values will add up to the address value, and turning these switches on. Do so by doing the following:

1. Determine the largest value switch that is less than the start address. Turn this switch on.
2. Subtract the value of the switch you just turned on from the starting address number.
3. Determine the largest value switch that is less than the remainder from the previous subtraction. Turn this switch on.
4. Subtract the value of the switch you just turned on from the remainder of the previous subtraction.
5. Repeat steps three and four until you have a remainder of zero.

EXAMPLE STARTING ADDRESS

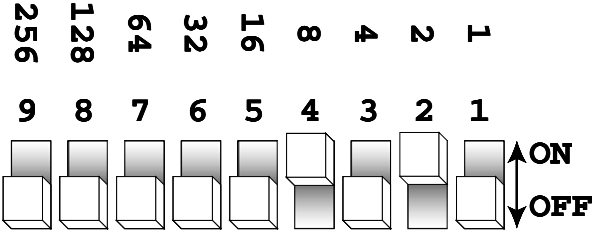
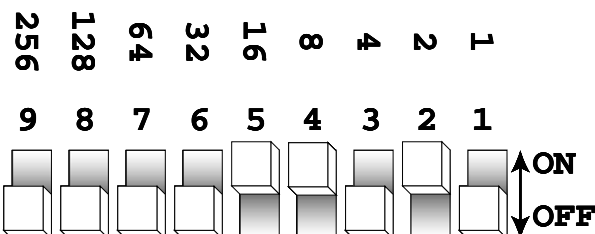
<p>Address 10</p> <p>Switch # 4 = 8 Switch # 2 = 2 Total = 10</p>																					
<p>Address 24</p> <p>Switch # 5 = 16 Switch # 4 = 8 Total = 24</p>																					
<p>Resolving address using simple math.</p> <p>Address 233</p>	<p>233 - (128) = 105, Turn ON Dip # 8 105 - (64) = 41, Turn ON Dip # 7 41 - (32) = 9, Turn ON Dip # 6 9 - (8) = 1, Turn ON Dip # 4 1 - (1) = 0, Turn ON Dip # 1</p> <table border="1" data-bbox="1073 1644 1383 1938"> <thead> <tr> <th>DIP SWITCH</th> <th>(DMX VALUE)</th> </tr> </thead> <tbody> <tr><td>1</td><td>1</td></tr> <tr><td>2</td><td>2</td></tr> <tr><td>3</td><td>4</td></tr> <tr><td>4</td><td>8</td></tr> <tr><td>5</td><td>16</td></tr> <tr><td>6</td><td>32</td></tr> <tr><td>7</td><td>64</td></tr> <tr><td>8</td><td>128</td></tr> <tr><td>9</td><td>256</td></tr> </tbody> </table>	DIP SWITCH	(DMX VALUE)	1	1	2	2	3	4	4	8	5	16	6	32	7	64	8	128	9	256
DIP SWITCH	(DMX VALUE)																				
1	1																				
2	2																				
3	4																				
4	8																				
5	16																				
6	32																				
7	64																				
8	128																				
9	256																				

DMX Quick Reference Chart

DMX Address Quick Reference Chart																				
DIP Switch Position																				
DMX DIP SWITCH SET		#9	0	0	0	0	0	0	0	0	1	1	1	1	1	1	1			
0=OFF		#8	0	0	0	0	1	1	1	1	0	0	0	0	1	1	1			
1=ON		#7	0	0	1	1	0	0	1	1	0	0	1	1	0	0	1			
X=OFF or ON		#6	0	1	0	1	0	1	0	1	0	1	0	1	0	1	0			
#1	#2	#3	#4	#5																
0	0	0	0	0		32	64	96	128	160	192	224	256	288	320	352	384	416	448	480
1	0	0	0	0	1	33	65	97	129	161	193	225	257	289	321	353	385	417	449	481
0	1	0	0	0	2	34	66	98	130	162	194	226	258	290	322	354	386	418	450	482
1	1	0	0	0	3	35	67	99	131	163	195	227	259	291	323	355	387	419	451	483
0	0	1	0	0	4	36	68	100	132	164	196	228	260	292	324	356	388	420	452	484
1	0	1	0	0	5	37	69	101	133	165	197	229	261	293	325	357	389	421	453	485
0	1	1	0	0	6	38	70	102	134	166	198	230	262	294	326	358	390	422	454	486
1	1	1	0	0	7	39	71	103	135	167	199	231	263	295	327	359	391	423	455	487
0	0	0	1	0	8	40	72	104	136	168	200	232	264	296	328	360	392	424	456	488
1	0	0	1	0	9	41	73	105	137	169	201	233	265	297	329	361	393	425	457	489
0	1	0	1	0	10	42	74	106	138	170	202	234	266	298	330	362	394	426	458	490
1	1	0	1	0	11	43	75	107	139	171	203	235	267	299	331	363	395	427	459	491
0	0	1	1	0	12	44	76	108	140	172	204	236	268	300	332	364	396	428	460	492
1	0	1	1	0	13	45	77	109	141	173	205	237	269	301	333	365	397	429	461	493
0	1	1	1	0	14	46	78	110	142	174	206	238	270	302	334	366	398	430	462	494
1	1	1	1	0	15	47	79	111	143	175	207	239	271	303	335	367	399	431	463	495
0	0	0	0	1	16	48	80	112	144	176	208	240	272	304	336	368	400	432	464	496
1	0	0	0	1	17	49	81	113	145	177	209	241	273	305	337	369	401	433	465	497
0	1	0	0	1	18	50	82	114	146	178	210	242	274	306	338	370	402	434	466	498
1	1	0	0	1	19	51	83	115	147	179	211	243	275	307	339	371	403	435	467	499
0	0	1	0	1	20	52	84	116	148	180	212	244	276	308	340	372	404	436	468	500
1	0	1	0	1	21	53	85	117	149	181	213	245	277	309	341	373	405	437	469	501
0	1	1	0	1	22	54	86	118	150	182	214	246	278	310	342	374	406	438	470	502
1	1	1	0	1	23	55	87	119	151	183	215	247	279	311	343	375	407	439	471	503
0	0	0	1	1	24	56	88	120	152	184	216	248	280	312	344	376	408	440	472	504
1	0	0	1	1	25	57	89	121	153	185	217	249	281	313	345	377	409	441	473	505
0	1	0	1	1	26	58	90	122	154	186	218	250	282	314	346	378	410	442	474	506
1	1	0	1	1	27	59	91	123	155	187	219	251	283	315	347	379	411	443	475	507
0	0	1	1	1	28	60	92	124	156	188	220	252	284	316	348	380	412	444	476	508
1	0	1	1	1	29	61	93	125	157	189	221	253	285	317	349	381	413	445	477	509
0	1	1	1	1	30	62	94	126	158	190	222	254	286	318	350	382	414	446	478	510
1	1	1	1	1	31	63	95	127	159	191	223	255	287	319	351	383	415	447	479	511

DIP Switch Position

DMX Address

5. TECHNICAL INFORMATION

General Maintenance



All fog machines are prone to clogging due to the thick consistency of fog liquid and the high temperature at which it vaporizes. However, a properly maintained fog machine should provide years of reliable use. Cleaning your fog machine regularly will help reduce costly replacement and repair charges.

Do not allow the fog machine to become contaminated. Chauvet recommends after every 40 hours of continuous operation, run a cleaning solution composed of 80% distilled water and 20% distilled vinegar through the system to prevent the accumulation of particulate matter in the heating element.

The recommended cleaning regimen is:

1. Empty all fog liquid from the machine. Add cleaning solution to tank. Plug unit in and begin warm up.
2. Run the unit in a well-ventilated area until the tank is almost empty. Do not allow the pump to run dry.
3. Cleaning is now complete. Refill with fog liquid. Run the machine briefly to clear any cleaning solution from the pump and heater.
4. Do not operate the machine without liquid at any time.



FCQ (Fog Cleaner Quart) was specifically developed by Chauvet to clean your Hurricane™ 1800 Flex. Make sure you use FCQ regularly to increase the life of your fogger.

Storage

1. When storing run distilled water (not tap water) through the system as described in the cleaning regimen above. This will help avoid any particles condensing inside the pump or heater.
2. It is strongly recommended to test-run the machine on a monthly basis in order to achieve its best fogging condition.



- **Never place the fog/hazer machine on any flammable material (i.e. carpet, fabric etc.) during operation. All fog/hazer machines should always be on a non-flammable surface, such as concrete or tile.**
- **Depending on the amount of fog/haze generated, all fog machines may set off smoke detectors.**

General Troubleshooting

Symptom	Solution(s)	Applies to			
		Lights	Foggers & Snow	Controllers	Dimmers & Chaser
Loss of signal	Use only DMX cables Install terminator Note: Keep DMX cables separated from power cables or black lights.	Ü	Ü	Ü	Ü
Remote does not work	Make sure connector is firmly connected to device	Ü	Ü		

If you still have a problem after trying the above solutions, please contact CHAUVET® Technical Support at the location listed below.

Contact Information

World Headquarters

CHAUVET®

General Information

Address: 5200 NW 108th Avenue
Sunrise, FL 33351
Voice: (954) 577-4455
Fax: (954) 929-5560
Toll free: (800) 762-1084

Technical Support

Voice: (954) 577-4455 (Press 4)
Fax: (954) 756-8015

World Wide Web www.chauvetlighting.com

United Kingdom & Ireland

CHAUVET® Europe Ltd.

General Information

Address: Unit 1C
Brookhill Road Industrial Estate
Pinxton, Nottingham, UK
NG16 6NT
Voice: +44 (0)1773 511115
Fax: +44 (0)1773 511110
Email: uktech@chauvetlighting.com

World Wide Web www.chauvetlighting.co.uk

Returns Procedure

The user must send the merchandise prepaid, in the original box, and with its original packing and accessories. CHAUVET® will not issue call tags.

Call CHAUVET® and request a Return Merchandise Authorization Number (RMA #) before shipping the product. Be prepared to provide the model number, serial number, and a brief description of the cause for the return.

The user must clearly label the package with a Return Merchandise Authorization Number (RMA #). CHAUVET® will refuse any product returned without an RMA #.



DO NOT write the RMA # directly on the box. Instead, write it on a properly affixed label.

Once you have received the RMA #, please include the following information on a piece of paper inside the box:

1. Your name
2. Your address
3. Your phone number
4. The RMA #
5. A brief description of the problem

Be sure to pack the product properly. Any shipping damage resulting from inadequate packaging will be the customer's responsibility. As a suggestion, proper UPS packing or double-boxing is always a safe method to use.



CHAUVET® reserves the right to use its own discretion to repair or replace returned product(s).

6. APPENDIX

DMX Primer

There are 512 channels in a DMX-512 connection. Channels may be assigned in any manner. A product capable of receiving DMX 512 will require one or a number of sequential channels. The user must assign a starting address on the product that indicates the first channel reserved in the controller. There are many different types of DMX controllable products and they all may vary in the total number of channels required. Choosing a start address should be planned in advance. Channels should never overlap. If they do, this will result in erratic operation of the products whose starting address is set incorrectly. You can however, control multiple products of the same type using the same starting address as long as the intended result is that of unison movement or operation. In other words, the products will be slaved together and all respond exactly the same.

DMX products are designed to receive data through a serial Daisy Chain. A Daisy Chain connection is where the DATA OUT of one product connects to the DATA IN of the next product. The order in which the products are connected is not important and has no effect on how a controller communicates to each product. Use an order that provides for the easiest and most direct cabling. Connect products using shielded two conductor twisted pair cable with three pin XLR male to female connectors. The shield connection is pin 1, while pin 2 is Data Negative (S-) and pin 3 is Data positive (S+).

Technical Specifications

WEIGHT & DIMENSIONS

Length.....	22.2 in (563 mm)
Width	13.4 in (340 mm)
Height	15.0 in (380 mm)
Weight.....	27.6 lbs (12.5 kg)

POWER

AC power (voltage specific)	115 VAC, 60 Hz or 230 VAC, 50Hz
Breaker size (120 V version)	15 A, 125 V
Power Consumption	1,364 W (11.9 A) max @ 120 V
Inrush current	(11.7 A) @ 120 V
Power Factor.....	0.99 @ 120 V
Breaker size (230 V version)	8 A, 250 V
Power Consumption	1,300 W (5.7 A) max @ 230 V
Inrush current	(6 A) @ 230 V
Power Factor.....	0.99 @ 230 V
Output.....	25,000 cfm
Fluid consumption.....	150 ml/min

THERMAL

Maximum ambient temperature	104° F (40° C)
-----------------------------------	----------------

CONTROL & PROGRAMMING

Data input.....	locking 3-pin XLR male socket
Data output.....	locking 3-pin XLR female socket
Data pin configuration (3-pin)	pin 1 shield, pin 2 (-), pin 3 (+)
Data input.....	locking 5-pin XLR male socket
Data output.....	locking 5-pin XLR female socket
Data pin configuration (5-pin).....	pin 1 shield, pin 2 (-), pin 3 (+), pin 4 (not used), pin 5 (not used)
Protocols	DMX-512 USITT
DMX Channels	1

ORDERING INFORMATION

Hurricane™ 1800 Flex	HURRICANE1800FLEX
----------------------------	-------------------

WARRANTY INFORMATION

Warranty	1-year limited warranty
----------------	-------------------------