



Loudspeaker System



XRT2K Owner's Manual



WARNING - TO REDUCE RISK OF FIRE OR ELECTRICAL SHOCK, DO NOT EXPOSE THIS EQUIPMENT TO RAIN OR MOISTURE.

NO USER-SERVICEABLE PARTS INSIDE. REFER SERVICING TO QUALIFIED PERSONNEL.

To prevent the risk of electric shock, do not remove cover or back. No user serviceable parts inside.

IMPORTANT SAFETY INSTRUCTIONS!

PLEASE READ THEM BEFORE OPERATING THIS EQUIPMENT.

1. Read these instructions.
2. Keep these instructions.
3. Heed all warnings.
4. Follow all instructions.
5. Do not use this apparatus near water.
6. Clean only with a non-abrasive dry soft cloth.
7. Install in accordance with the manufacturer's instructions.
8. **This Loudspeaker is capable of producing extremely high sound pressure levels, even when connected to amplifiers of moderate power output. User caution is advised. Ear protection is recommended when playing at high volumes as continued exposure to high sound pressure levels can cause permanent hearing impairment or loss. The use of a Sound Level Pressure Meter will greatly aid in determining when high volume levels are occurring.**
9. Do not install near any heat sources such as radiators, heat registers, stoves, or other apparatus (including amplifiers) that produce heat.
10. Only use attachments/accessories specified by the manufacturer.
11. Use only with the cart, stand, tripod, bracket, or table specified by the manufacturer, or sold with the apparatus. When a cart is used, use caution when moving the cart/apparatus combination to avoid injury from tip-over.
12. Refer all servicing to qualified service personnel. Servicing is required when the apparatus has been damaged in any way, liquid has been spilled or objects have fallen into the apparatus, the apparatus has been exposed to rain or moisture, does not operate normally, or has been dropped.
13. Do not expose this equipment to dripping or splashing and ensure that no objects filled with liquids, such as vases, are placed on the equipment.
14. **WARNING: When this Loudspeaker is connected to an amplifier that is Powered On, the connection terminals may have hazardous live voltages present with a risk of electric shock.**
15. **CAUTION: When this Loudspeaker is assembled it weighs 452 pounds (205.0 kgs). It requires four or more persons to safely move the Loudspeaker.**



Thank You

Your decision to own this McIntosh XRT2K Loudspeaker System ranks you at the very top among discriminating music listeners. You now have “The Best.” The McIntosh dedication to “Quality,” is assurance that you will receive many years of musical enjoyment from this unit.

Please take a short time to read the information in this manual. We want you to be as familiar as possible with all the features and functions of your new McIntosh.

Please Take A Moment

The serial number, purchase date and McIntosh Dealer name are important to you for possible insurance claim or future service. The spaces below have been provided for you to record that information:

Serial Number: _____

Purchase Date: _____

Dealer Name: _____

Technical Assistance

If at any time you have questions about your McIntosh product, contact your McIntosh Dealer who is familiar with your McIntosh equipment and any other brands that may be part of your system. If you or your Dealer wish additional help concerning a suspected problem, you can receive technical assistance for all McIntosh products at:

McIntosh Laboratory, Inc.
2 Chambers Street
Binghamton, New York 13903
Phone: 607-723-1545
Fax: 607-724-0549

Customer Service

If it is determined that your McIntosh product is in need of repair, you can return it to your Dealer. You can also return it to the McIntosh Laboratory Service Department. For assistance on factory repair return procedure, contact the McIntosh Service Department at:

McIntosh Laboratory, Inc.
2 Chambers Street
Binghamton, New York 13903
Phone: 607-723-3515
Fax: 607-723-1917

Table of Contents

Safety Instructions	2
Thank You and Please Take a Moment	3
Technical Assistance and Customer Service	3
Table of Contents and Important Information	3
Introduction	4
Performance Features	5
Dimensions	6-8
Unpacking and Assembly	9-10
Room Placement	11
Midrange/High Frequency Column, Low Frequency Column Base Connections	12
Low Frequency Column Rear Panel Connections	13
How to Connect using a single amplifier	14
How to Connect using two amplifiers	16
How to Connect using three amplifiers	18
Photos	20-21
Specifications	22
Packing Instruction	23

Important Information

Caution: The XRT2K when assembled weight is 452 pounds (205.0kg). It requires four or more persons to safely handle the Loudspeaker System.

1. Loudspeaker Cables of adequate size are important to ensure that there will be no significant power loss or heating. Cable size is specified in Gauge numbers or AWG (American Wire Gauge). The smaller the Gauge number, the larger the wire size:
 If the Loudspeaker Cables are 50 feet (38.1m) or less, use at least 12 Gauge (AWG) wire size or larger.
 If the Loudspeaker Cables are 100 feet (76.2m) or less, use at least 10 Gauge (AWG) wire size or larger.
2. For additional connection information, refer to the owner's manual(s) for any component(s) connected to the XRT2K Loudspeaker.
3. The XRT2K's built-in speaker protection incorporates five automatic resetting solid-state devices in the crossover networks. One protects the tweeters, one for the midranges and three for the woofers. The protection allows a certain amount of overdrive but extended periods will trigger protection. If an obvious lack of high, mid or low frequencies is noticed, the Protection Device may have activated. These devices will automatically reset when the volume level is reduced significantly and kept low until the output of the affected Loudspeaker Element returns to normal.
4. When the XRT2K Loudspeaker System is driven by more than one amplifier, the output levels of the different amplifiers connected to the Loudspeaker System must be adjusted to achieve a proper balance between the low, midrange and high frequencies reproduced. This adjustment is best achieved through the use of audio test equipment operated by a qualified installer.



Introduction

For the first time, the new McIntosh XRT2K Loudspeaker System is capable of reproducing the full dynamic range of a symphony orchestra including pipe organ without audible distortion. McIntosh Acoustic Engineers have refined the line source Column Loudspeaker concept and the XRT2K Loudspeaker System is the 6th in a generation of that patented design¹. It provides superior quality midrange and high frequency sound reproduction in a full range system.

The High Frequency Section utilizes a patented Column Design¹ with multiple two inch Midrange Inverted Titanium Dome Drivers and three-quarter inch Titanium Dome Tweeters. Refer to figures 1 and 2. Since the audio power fed to a column is distributed among all the drivers, each driver does not have to work as hard, resulting in greater power handling capability and a dramatic reduction in distortion. The Sound Waves from the Column produce a Cylindrical Wave Front

with a stable symmetrical horizontal sound dispersion while minimizing undesirable floor and ceiling reflections that detract from a stable sound image. Refer to figure 3. In the illustration, the Loudspeaker on the left side produces a Cylindrical Wave Front and the Loudspeaker on the right side produces a conventional Spherical Wave Front.

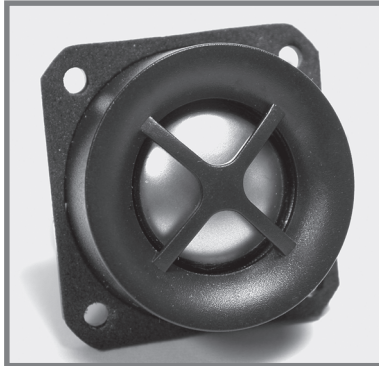

Figure 1

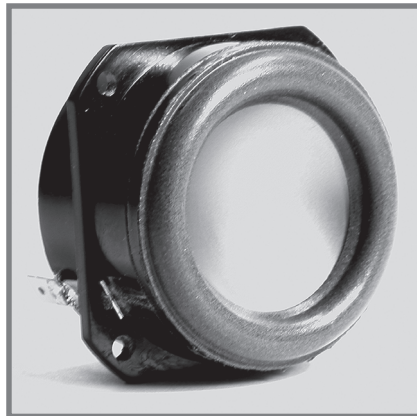

Figure 2

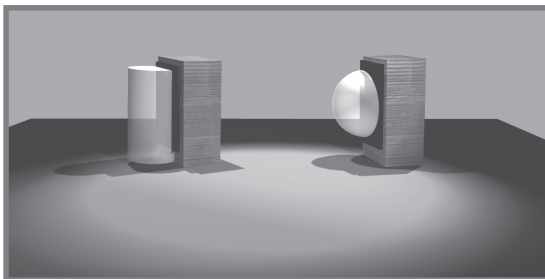

Figure 3

The Low Frequency Section of the System consists of six 12 inch Aluminum Cone Woofers capable of long cone excursions. The sound produced has very low levels of harmonic distortion and a frequency response down to 16Hz.

They have a large motor assembly made with High Temperature



Figure 4

Neodymium magnets with inherent shielding to greatly reduce any external magnetic field. Refer to figure 4. The woofer design also utilizes an aluminum shorting ring, copper capped pole piece, three inch diameter voice coil and two cone centering devices. This results in lower distortion due to more linear magnetic flux in the voice coil gap. A good example of this low distortion is incredible smoothness and effortless clarity in the reproduction of the human voice.

The Crossover Networks used in the XRT2K Loudspeaker System are designed to ensure a smooth frequency response over the entire audible range. The Low Frequency Crossover Network is a quasi-second order design. Refer to figure 5. Along with the column arrangement, this network

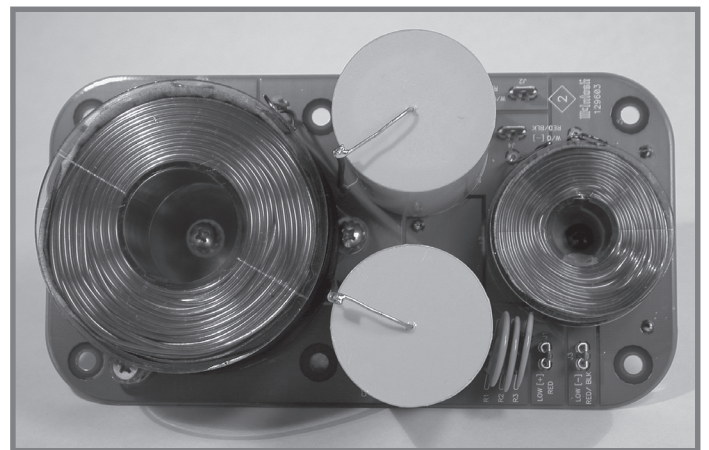

Figure 5

acoustically sums to a fourth order Linkwitz-Riley low pass. The Midrange Crossover Network is a second order high pass and low pass design. Refer to figure 6. Acoustically, the high pass sums to a fourth order Legendre and the

¹COLUMN Pat. No. 4,267,405

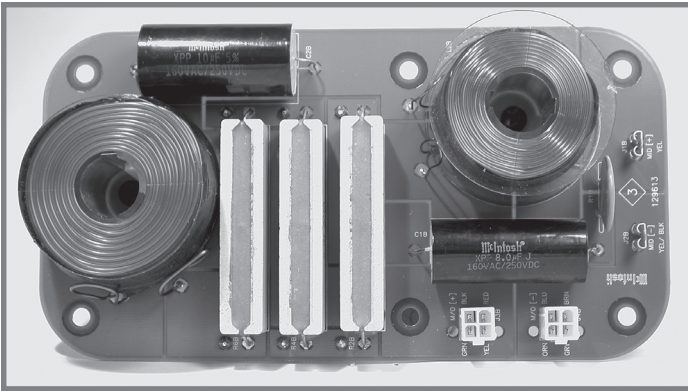

Figure 6

low pass sums to a fourth order Linkwitz-Riley. The Tweeter Crossover Network is a second order design; however, this acoustically sums to a fourth order Linkwitz-Riley high pass. Refer to figure 7. All these acoustic Fourth

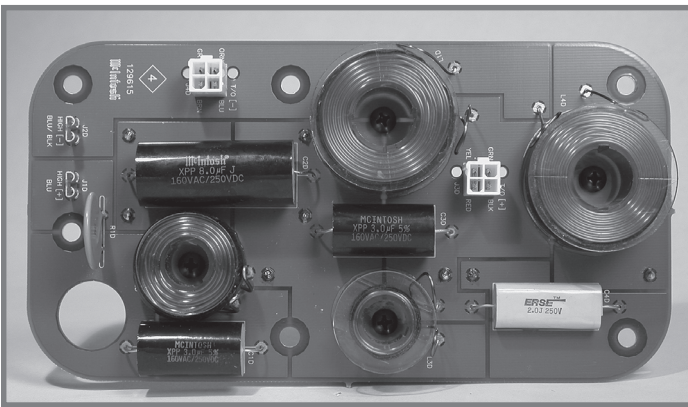

Figure 7

Order designs keep the speakers operating within their optimum frequency range while offering the best blending of each speaker. All network inductors are air core designs; so they will not add distortion. All network capacitors are film type for extra reliability. All the Capacitors and Inductors are chosen for high current capacity. Each section of the network utilizes its own self resetting high current PTC type fuses to provide an extra measure of protection.

Performance Features

- **High Temperature Neodymium-Iron-Boron Alloy Magnets**

The 6 twelve inch Woofers, 64 four inch Midranges and 40 three-quarter inch Dome Tweeters all use this Alloy. The Neodymium-Iron-Boron Alloy has the highest flux density per unit of volume and helps to keep the Loudspeaker Sys-

tem weight to a minimum while preserving the utmost in performance.

- **Shielded Magnetic Field**

The XRT2K may also be used in Home Theater Installations near a television receiver or monitor without causing the television image to degrade. By design, all of the speakers' magnetic structures are inherently shielded which prevents interference.

- **Low Harmonic and Intermodulation Distortion**

The XRT2K Loudspeaker System is capable of reproducing the full dynamic range of a symphony orchestra including pipe organ without audible distortion of any kind.

- **High Power Handling**

The Loudspeaker Elements and Crossover Components of the XRT2K are all chosen for use with powerful amplifiers up to 2,000 watts.

- **Superior Imaging**

Locating the Column of Tweeters between the two Columns of Midranges generates a symmetrical horizontal polar response for superior imaging.

- **Versatile Operation and Placement**

In addition to the regular connections, the XRT2K Loudspeaker System provides separate connections for Bi-Amplification and Tri-Amplification hookups, as well as Bi-Wiring and Tri-Wiring.

- **Extruded and Machined Side Panels and Column**

The sides of the XRT2K Low Frequency enclosures and the Midrange/Tweeter Column enclosure are machined from extruded thick aluminum panels to be non-parallel and are given a High Gloss Black Piano Type Finish.

- **Gold Plated Input Connectors**

The XRT2K input connectors are gold plated for superior corrosion resistance and high electrical conductivity.



Dimensions

The following dimensions can assist in determining the best location for your XRT2K Loudspeaker System.

**Front View of the
XRT2K
Loudspeaker System**

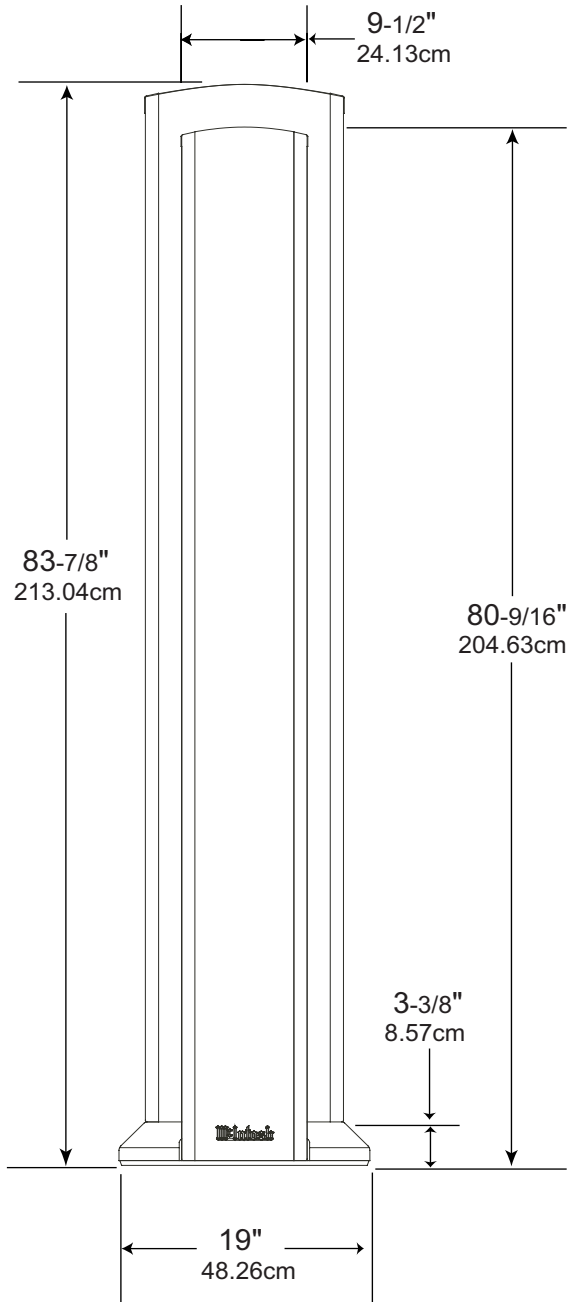

**Side View of the
XRT2K
Loudspeaker System**

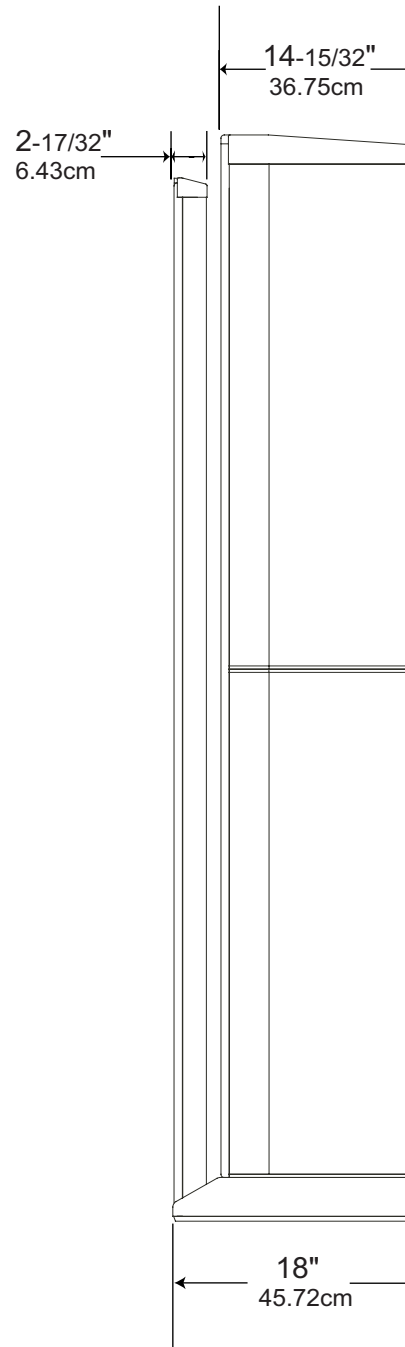

Rear View of the
XRT2K
Loudspeaker System

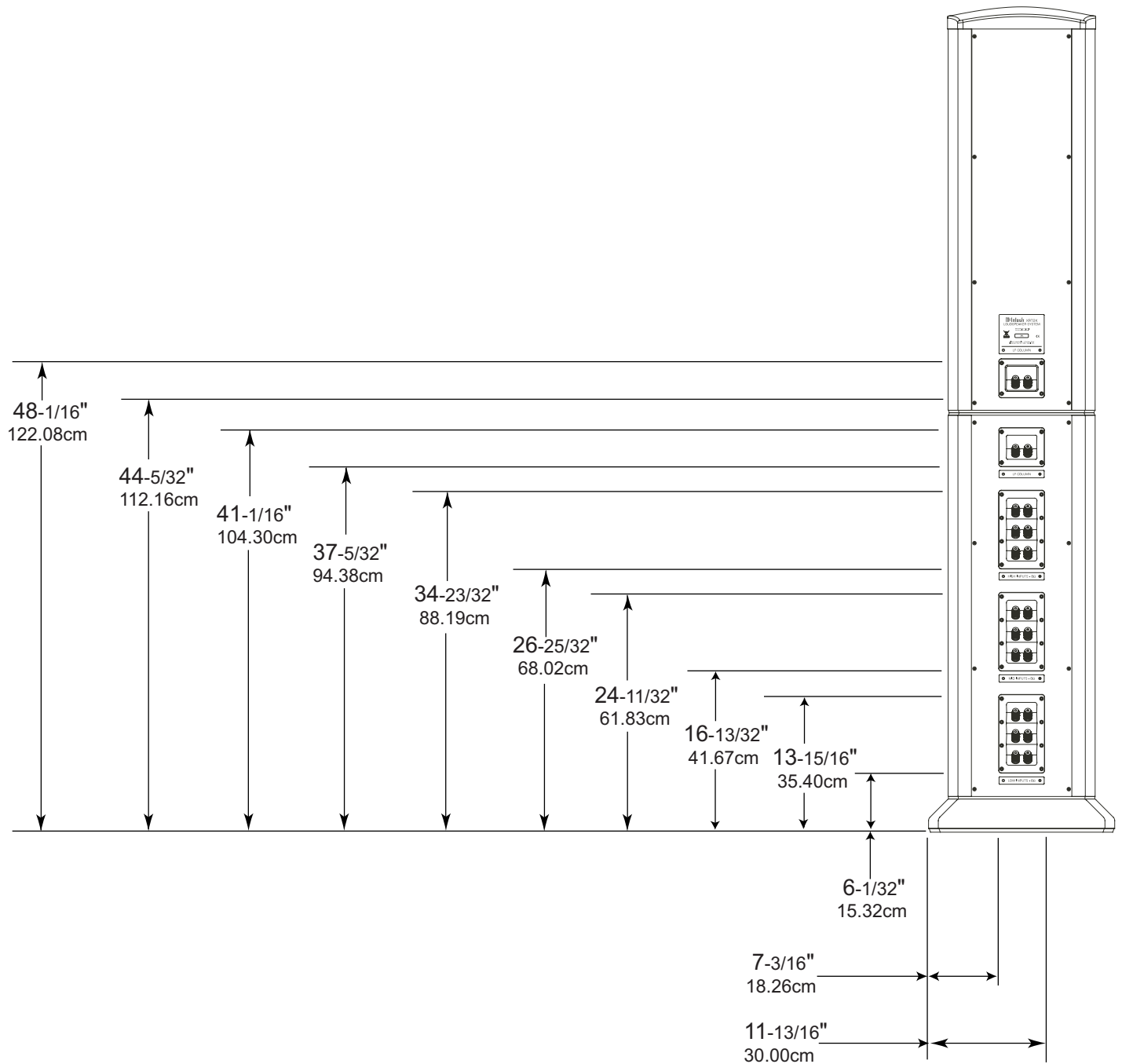

**Front View of the
XRT2K
Midrange and High Frequency Column**

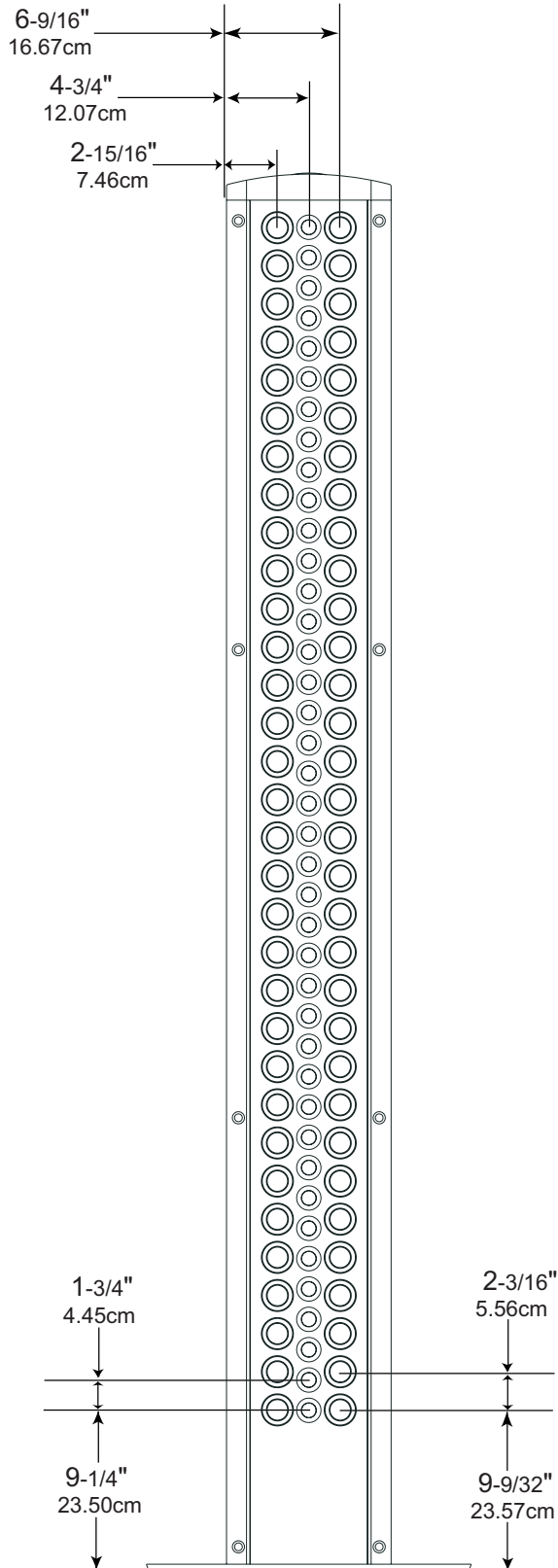

**Front View of the
XRT2K
Low Frequency Column**

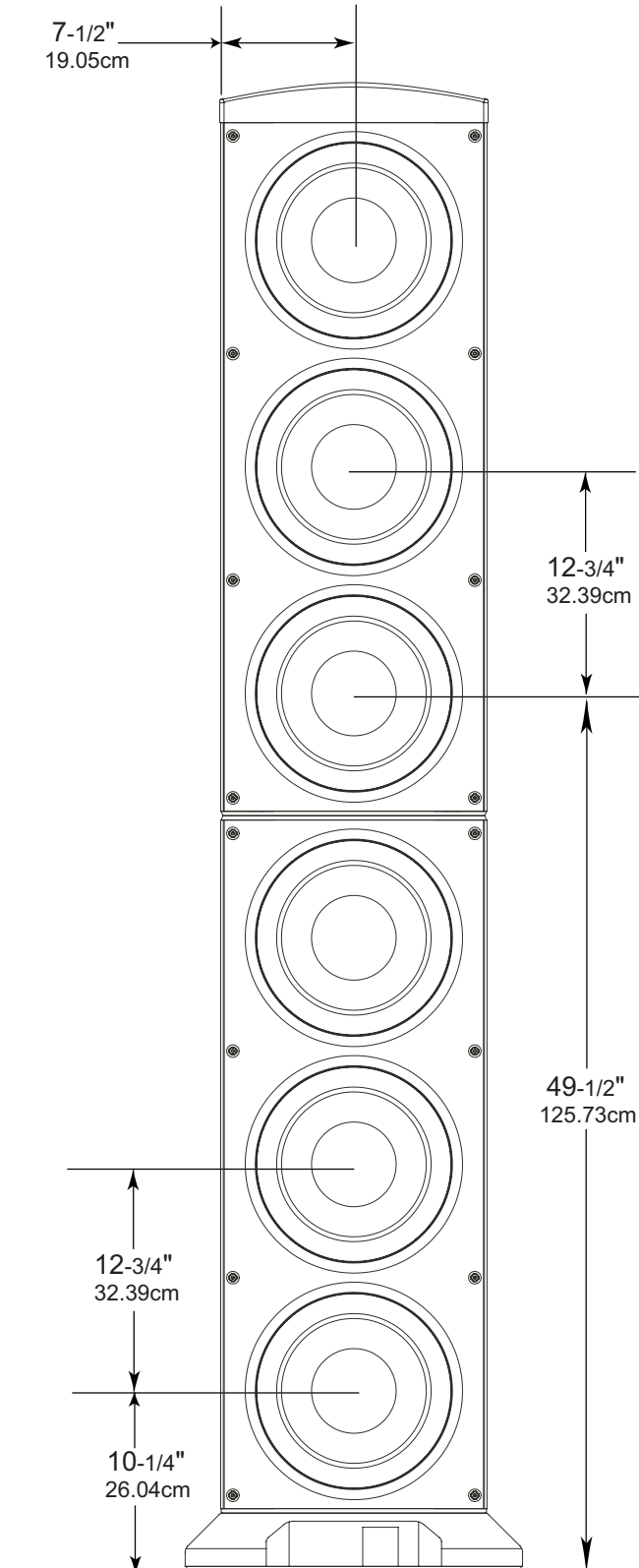

Unpacking and Assembly

Follow the instructions below for unpacking and assembling the XRT2K Loudspeaker System. To protect the fine finish of the XRT2K Loudspeaker System during the assembly process, it is advisable to prepare a suitable assembly area. A freshly vacuumed carpeted area covered with a soft, clean fabric, such as a large bed linen or blanket would be suitable. Start by unpacking the Midrange/High Frequency Column.

It is recommended that the Professionals at your McIntosh Dealer, who are skilled in all aspects of installation and operation, install the XRT2K Loudspeaker System and any associated audio equipment.

CAUTION: When this Loudspeaker is assembled it weighs 452 pounds (205.0 kgs). It requires four or more persons to safely handle during assembly and placement in the room.

Unpacking the Midrange/High Frequency Column

1. Remove the banding material from the shipping carton.
Refer to figure 1.
2. Lift off the top of the shipping carton and set it aside.
3. Remove the accessory carton from the shipping carton end.
4. Lift up on the rear of the Midrange/High Frequency Column, which is located under the larger Low Frequency Column Grille. Place the entire assembly (Midrange/High Frequency Column with Grille attached, Low Frequency Column Grille and foam packing material) in a safe area. Refer to figure 2.
5. Release the Low Frequency Column Grille from the foam packing material leaving it in the protective blue cloth cover and set it aside.
6. In a similar manner, release the Midrange/High Frequency Column with Grille in the protective blue cloth cover and set it aside.

Note: Save the pieces of foam packing material, as it will be used later during assembly of the Loudspeaker.

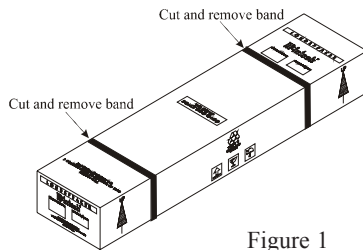

Figure 1

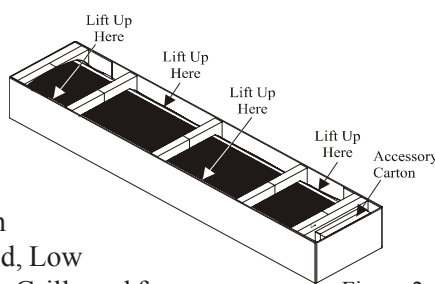

Figure 2

Unpacking the Low Frequency Column (Lower Section)

1. Remove the banding material from the shipping carton.
2. Lift off the top of the shipping carton and set it aside.
Note: When the top shipping carton is lifted up and away, the sides of the bottom shipping carton will unfold providing easier access to the column.
3. Remove the packing material from the bottom of the Low Frequency Column (with the base attached) and untie the draw cords on the bottom of the protective blue cloth cover.
4. Push the cloth cover up over the base of the column and position the column upright resting on its base.
5. Remove the remainder of the packing material from the column and the protective blue cloth cover.
Note: Save the protective blue cloth cover as it will be used later during assembly of the Loudspeaker.
6. Relocate the Low Frequency Column (Lower Section) onto the previously prepared assembly area with the Woofers facing upward. The bottom of the column base will need to be easily accessible for fastening both sections of the columns together. Sufficient space also needs to be provided for positioning the Low Frequency Column (Upper Section), next to be unpacked, with the Low Frequency Column (Lower Section).

Unpacking the Low Frequency Column (Upper Section)

1. Remove the banding material from the shipping carton.
2. Lift off the top of the shipping carton and set it aside.
3. Remove the packing material from the bottom of the Low Frequency Column (Upper Section) with the flat end and untie the draw cords on the bottom of the protective blue cloth cover.
4. Push the cloth cover up over the flat end of the column and position the column upright resting on its flat end.
5. Remove the remainder of the packing material from the column and the protective blue cloth cover.
Note: Save the protective blue cloth cover as it will be used later during assembly of the Loudspeaker.
6. Relocate the Low Frequency Column (Upper Section) together with the previously placed Low Frequency Column (Lower Section) in the assembly area.

Assembly of the Low Frequency Column (Lower and Upper Sections)

1. Locate the supplied tools in the Accessory Carton previously removed from the Midrange/High Frequency Column Shipping Carton.
2. Line up the three metal pins located on the top metal plate of the Low Frequency Column (Lower Section) with the three openings on the bottom metal plate of the

Low Frequency Column (Upper Section). Refer to figure 3.

- Carefully push together the two Low

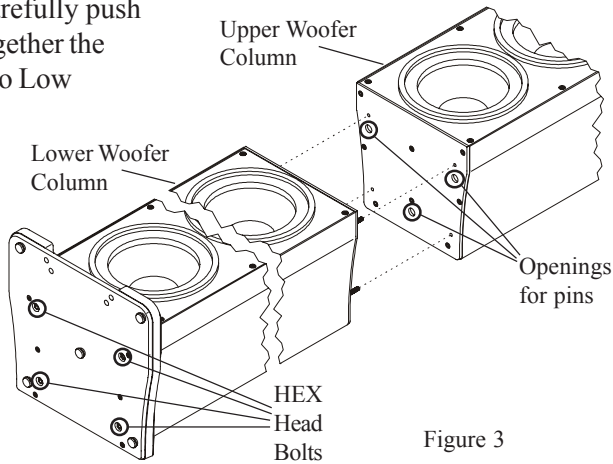

Figure 3

Frequency Columns (Lower and Upper Sections).

- Using the socket tool, tighten the four hex head bolts until the Low Frequency Column (Lower and Upper Sections) is pulled together with no space between the two sections.

Final Assembly of the Loudspeaker

- Locate the previously removed protective blue cloth covers and drape them over the top of the Low Frequency Column (Lower and Upper Sections), to tempo-

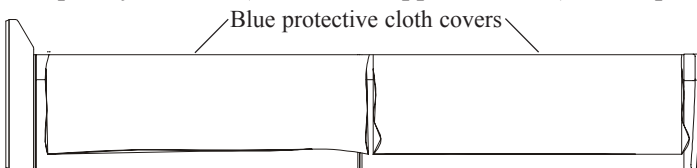

Figure 4

rarily protect the Woofers. Refer to figure 4.

- Place four pieces of foam packing material removed from the Midrange/High Frequency Column Shipping Carton, on top of the cloth covers placed in step 1. Refer to figure 5.

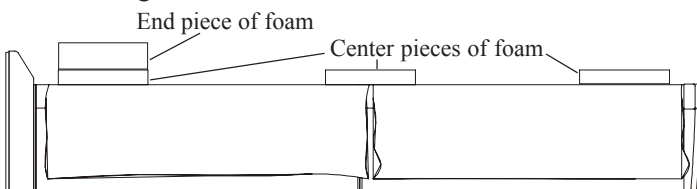

Figure 5

- Locate the Midrange/High Frequency Column and place it on top of the foam packing material placed in step 2, making sure the end with the draw cords is placed near the base end of the Low Frequency Column and the Grille is facing upwards. Refer to figure 6.

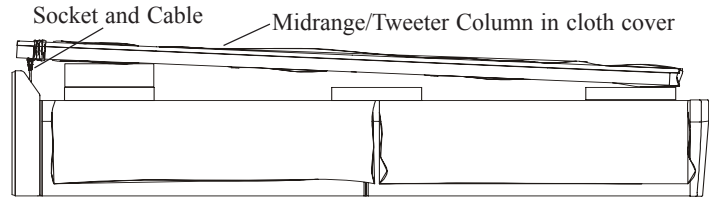

Figure 6

- Untie the cloth cover draw cords on the Midrange/High Frequency Column and push up the cover about six inches (15.24cm). Using the supplied "T" handle tool remove the hex head screws from the bottom of the column. These screws will be used later to fasten the Column to base in step number 8. Refer to figure 8.
- Locate the cable coming from inside the Low Frequency Column base and orient it to match up with the socket located on the rear of the Midrange/High Frequency Column.
- Insert the plug into the socket and rotate the locking collar clockwise until it is finger tight.
- Remove the end piece of foam, leaving the three center pieces of on top of the Low Frequency Column. Refer to figure 5. Then reposition the bottom of the Midrange/High Frequency Column to fit into the channel opening of the Low Frequency Column base. Refer to figure 7.

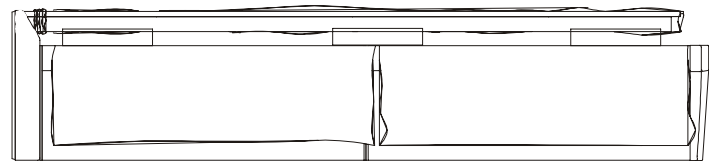

Figure 7

- Using the previously removed hex head screws and "T" handle tool, fasten the Midrange/High Frequency Column to the metal plate part of the Low Frequency Column base. Refer to figure 8.
- Position the Loudspeaker System upright resting on its base.

Note: Do not lift up on the Midrange/High Frequency Column.

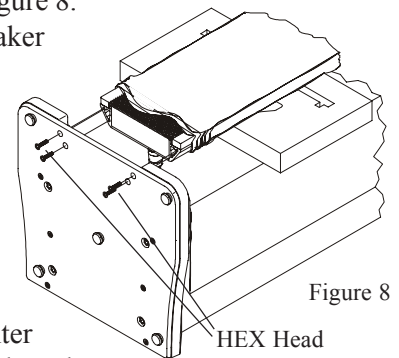

Figure 8

- Remove the three center foam packing materials and the three protective blue cloth covers.
- Remove the protective blue cloth cover from the Low Frequency Column Grille and attach the Grille to the Low Frequency Column.

Room Placement

Loudspeaker placement in a room can greatly affect performance. The XRT2K Loudspeaker is designed for both Music and Home Theater Systems. The optimal method for selecting speaker locations includes the use of a real time spectrum analyzer operated by an experienced system installer. An uncompromising installation would take into consideration the floor, wall and ceiling coverings, the type and placement of furniture and can even include the architectural design of the room and its construction materials. In those instances where placement in the room is fixed an environmental equalizer may be needed to restore proper musical balance.

Placement near a wall, corner, floor, ceiling or any intersecting surfaces will reinforce some bass frequencies. Which bass frequencies are boosted by placement in a particular location is dependent on the dimensions of the room. Test the various Loudspeaker locations by playing music with continuous bass, setting up the speakers and listening to them from the main listening spot. Move the Loudspeakers to an alternate location and repeat the listening, paying attention to how the bass qualities and response levels change. Do not assume the loudest bass is best; rather listen for booming (a lack of articulation), as well as a balance over the whole spectrum, to assure the bass will not drown out the other parts of the music. Experiment with various Loudspeaker positions until the locations that sound best are found.

The XRT2K Midrange/High Frequency Column's Smooth Frequency Response may be altered by large object(s) located in the sound waves path or by locating the column too close to a side wall. There should be an unobstructed area in front of the column of at least 60 degrees either side from the center axis for the best performance. Refer to figure 9.

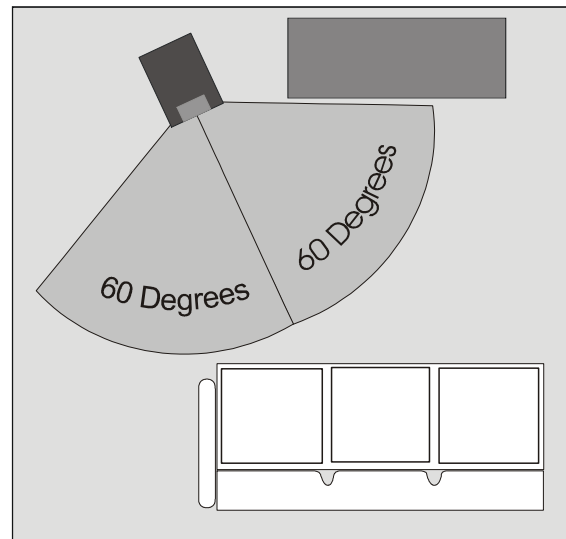

Figure 9

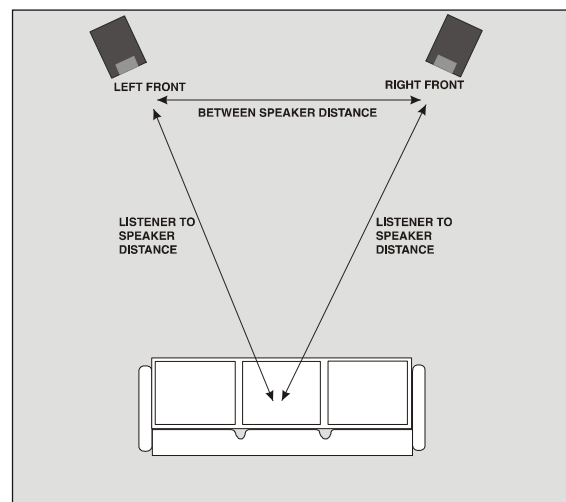

Figure 10

Locating Loudspeakers for use in Home Theater

In a Home Theater application, the placement of Left and Right Front Loudspeakers can be limited by such considerations as the size and location of the video monitor. The locating suggestions in the “for use in a Music System” section below can still be helpful as a starting place. Refer to figure 10.

Locating Loudspeakers for use in a Music System

When used in a Music System the distance between the Loudspeakers and the listener to the Loudspeakers should form an equilateral to an acute isosceles triangle. If the speakers are too far apart relative to the listener, some imaging can be lost. Refer to figure 11.

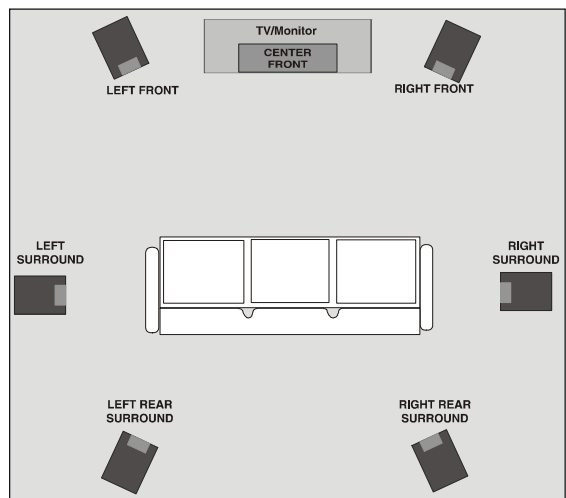
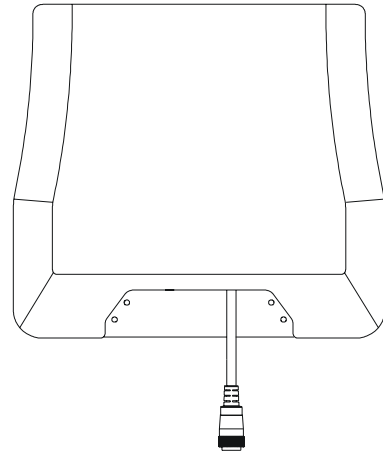
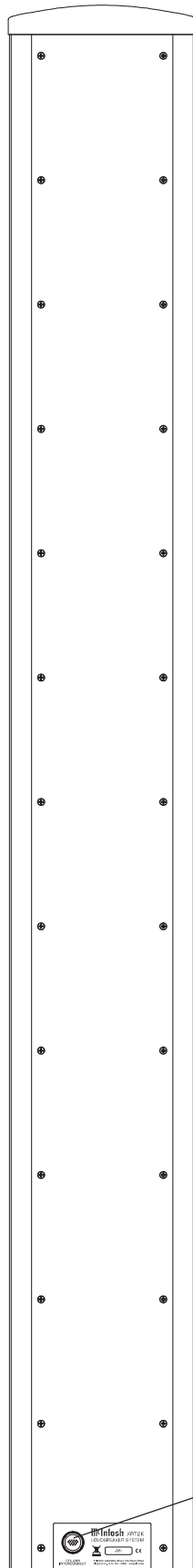

Figure 11



Midrange/Tweeter Column Rear Panel and Low Frequency Column Base Connections



The 16 pin plug and cable at the front bottom of the LOW Frequency Column Base connects to the MIDRANGE/HIGH Frequency Column 16 pin Connector

MIDRANGE/HIGH Frequency Column 16 pin Connector, connects to the 16 pin plug and cable coming from the LOW Frequency Column Base

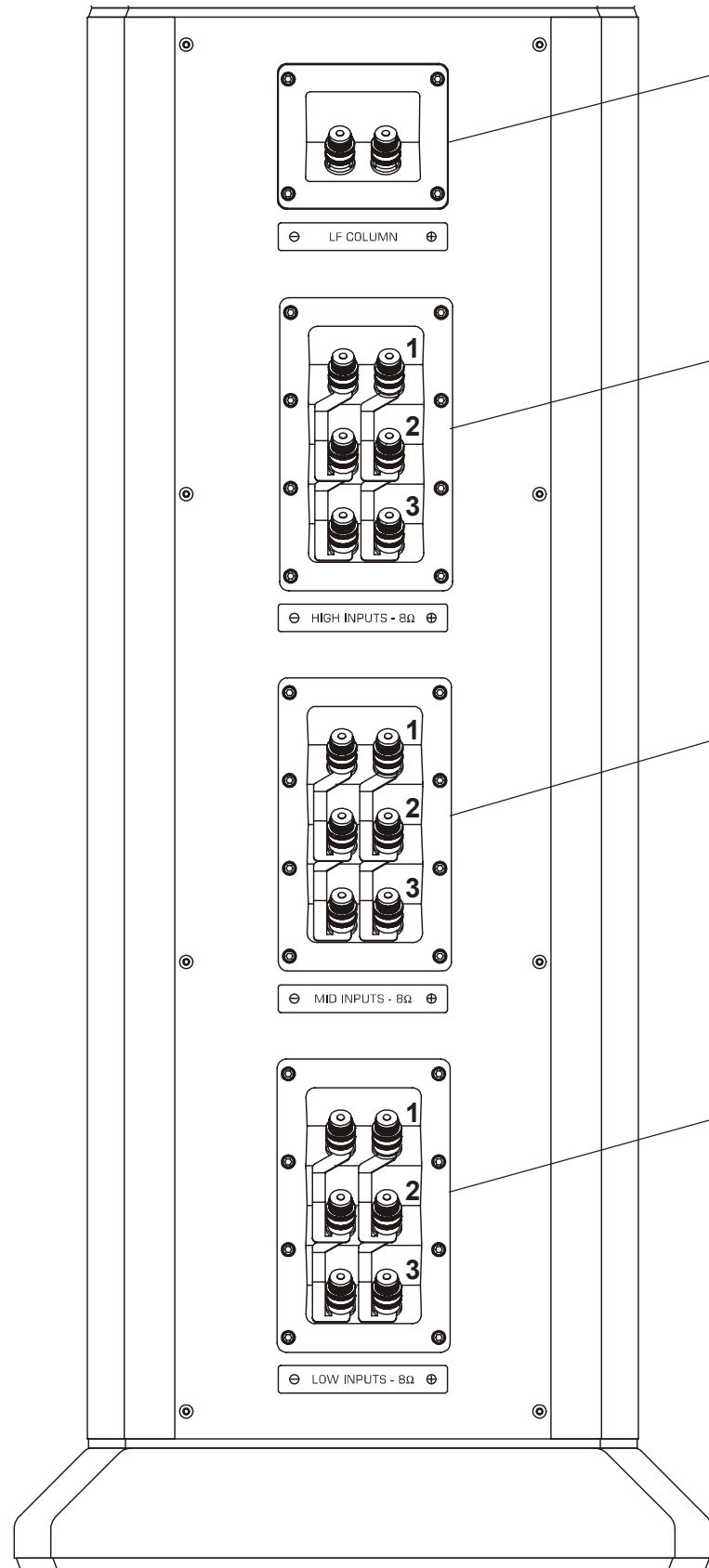

Low Frequency Column Lower Section Connections connect to the Low Frequency Column Upper Section Connections.
Note: Do not operate the XRT2K Loudspeaker System unless the Low Frequency Column Lower and Upper sections are connected together.

HIGH Frequency Input Connections 1, 2, and 3 for a 8 ohm Loudspeaker.
Note: 1, 2 and 3 Terminals (+) are internally connected together; 1, 2 and 3 Terminals (-) are also internally connected together.

MIDrange Frequency Input Connections 1, 2, and 3 for a 8 ohm Loudspeaker.
Note: 1, 2 and 3 Terminals (+) are internally connected together; 1, 2 and 3 Terminals (-) are also internally connected together.

LOW Frequency Input Connections 1, 2, and 3 for a 8 ohm Loudspeaker.
Note: 1, 2 and 3 Terminals (+) are internally connected together; 1, 2 and 3 Terminals (-) are also internally connected together.

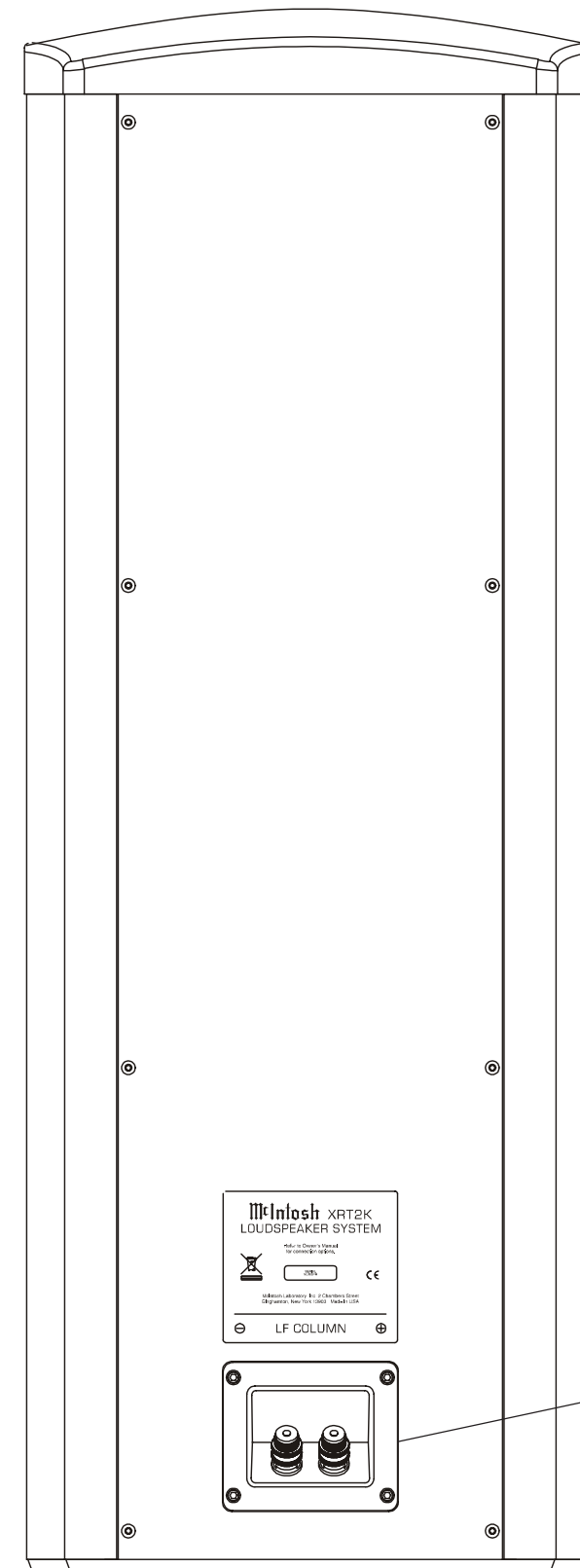

Low Frequency Column Upper Section Connections connect to the Low Frequency Column Lower Section Connections.
Note: Do not operate the XRT2K Loudspeaker System unless the Low Frequency Column Lower and Upper Sections are connected together.

How to Connect using a single Amplifier

Caution: *The AC Power Cord should not be connected to the Power Amplifier until after the Loudspeaker Connections have been made. Failure to observe this could result in Electric Shock.*

1. Prepare two 14 inch (35.6cm) Jumper Wires for connecting the Low Frequency Column, Lower and Upper Sections together by choosing one of the methods below:

Bare wire cable ends:

Carefully remove sufficient insulation from the cable ends, refer to figures 12, 13 & 14.

If the cable is stranded, carefully twist the strands together as tightly as possible.

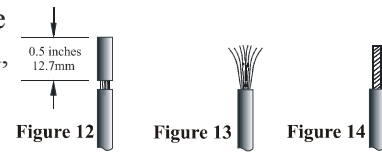

Note: If desired, the twisted ends can be tinned with solder to keep the strands together or attach spade lugs.

Spade lug or prepared wire connection:

Insert the spade lug connector or prepared section of the cable end into the terminal side access hole, and tighten the terminal cap until the cable is firmly clamped into the terminal so the wires cannot slip out. Refer to figures 15, 16 & 17.

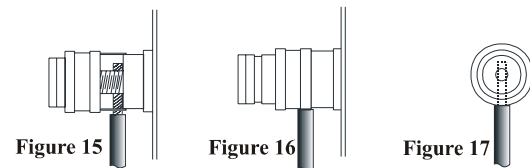

2. Connect a 14 inch Jumper Wire from the Low Frequency Column Upper Section (-) Binding Post to the Low Frequency Column Lower Section (-) Binding Post.
3. Connect a 14 inch Jumper Wire from the Low Frequency Column Upper Section (+) Binding Post to the Low Frequency Column Lower Section (+) Binding Post.
4. Connect a Loudspeaker cable from the XRT2K HIGH Frequency INPUTS 3 (-) Binding Post on the Low Frequency Column Lower Section to the (-) Binding Post C of the Power Amplifier.
5. Connect a Loudspeaker cable from the XRT2K HIGH Frequency INPUTS 3 (+) Binding Post on the Low Frequency Column Lower Section

to the (8 ohm) Binding Post C of the Power Amplifier.

6. Connect a Loudspeaker cable from the XRT2K MID Frequency INPUTS 3 (-) Binding Post on the Low Frequency Column Lower Section to the (-) Binding Post B of the Power Amplifier.
7. Connect a Loudspeaker cable from the XRT2K MID Frequency INPUTS 3 (+) Binding Post on the Low Frequency Column Lower Section to the (8 ohm) Binding Post B of the Power Amplifier.
8. Connect a Loudspeaker cable from the XRT2K LOW Frequency INPUTS 3 (-) Binding Post on the Low Frequency Column Lower Section to the (-) Binding Post A of the Power Amplifier.
9. Connect a Loudspeaker cable from the XRT2K LOW Frequency INPUTS 3 (+) Binding Post on the Low Frequency Column Lower Section to the (8 ohm) Binding Post A of the Power Amplifier.
10. Tighten all of the Loudspeaker and Amplifier Binding Posts.
11. Connect the remaining XRT2K Loudspeaker(s) and Power Amplifier Channel(s) in the same manner.

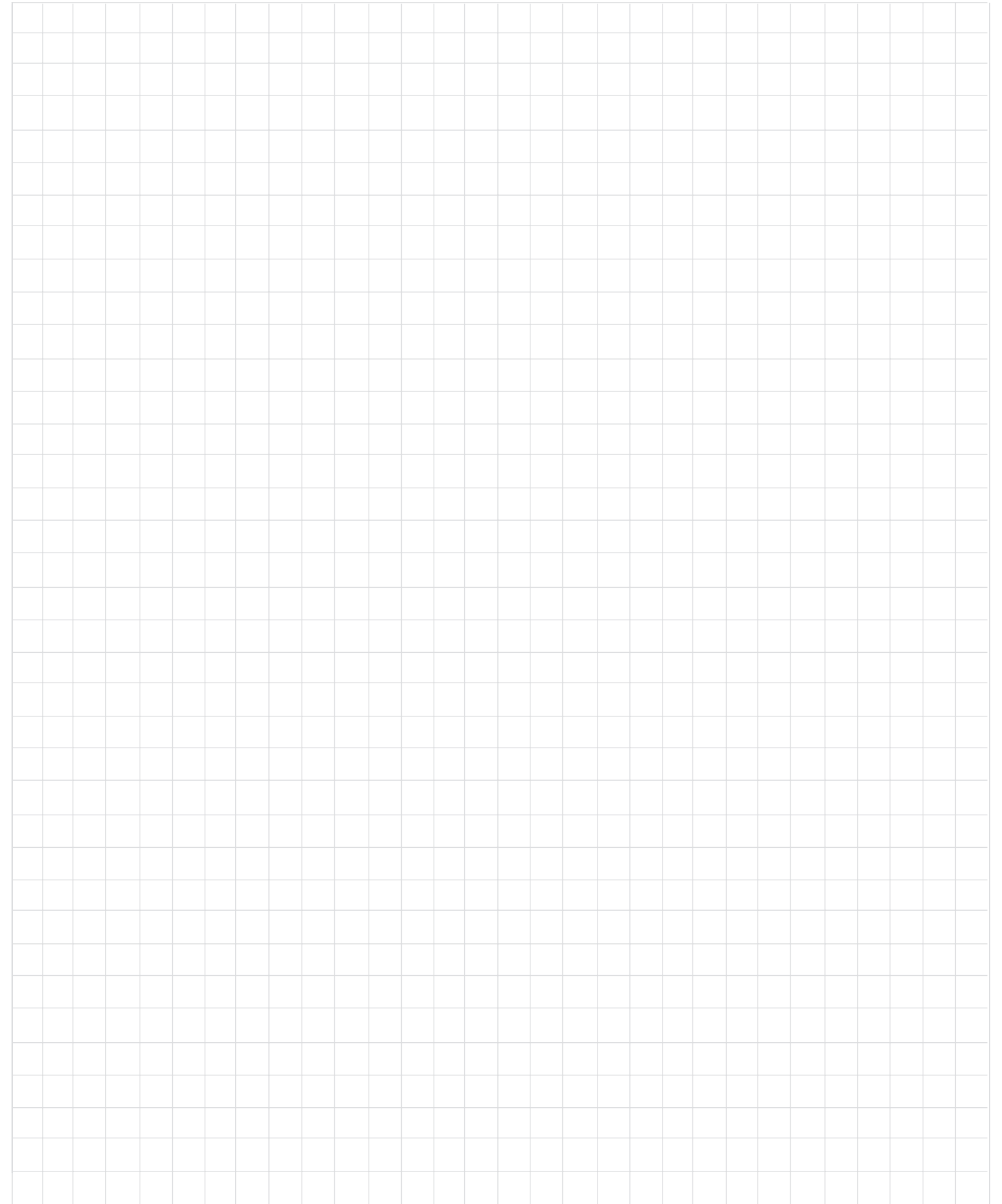

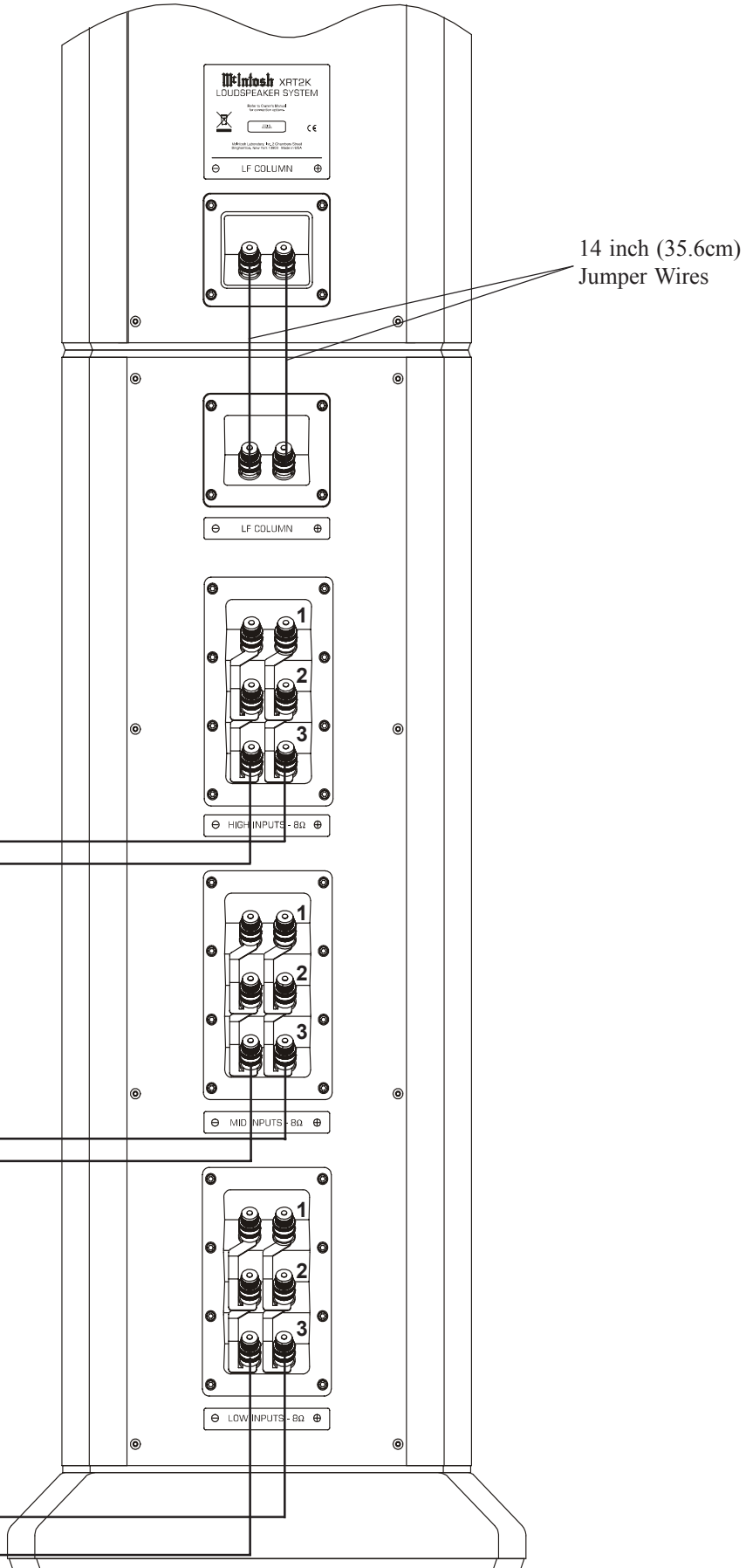
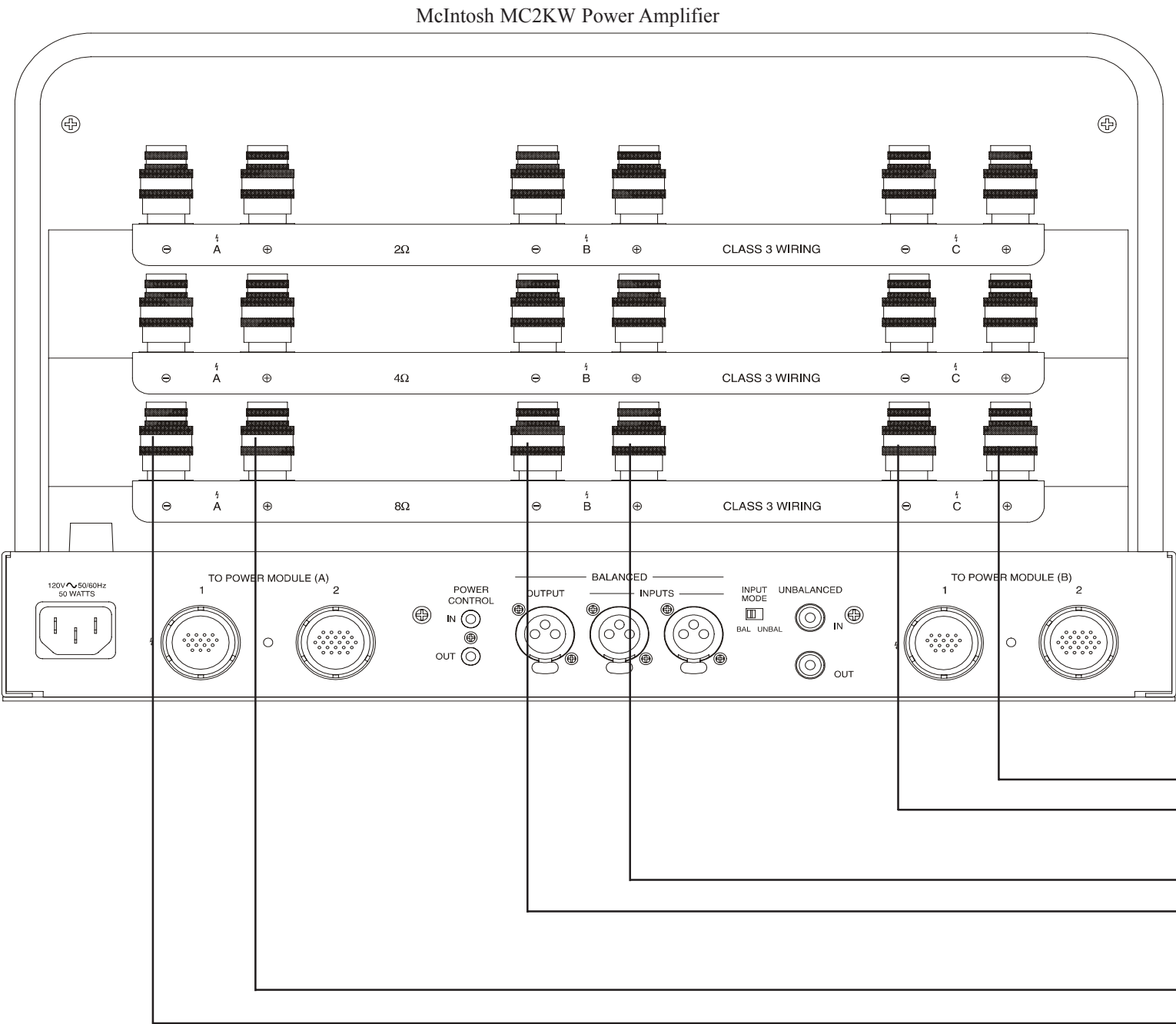

How to Connect using two Amplifiers

Caution: The AC Power Cord should not be connected to the Power Amplifier until after the Loudspeaker Connections have been made. Failure to observe this could result in Electric Shock.

1. Prepare two 14 inch (35.6cm) Jumper Wires for connecting the Low Frequency Column, Lower and Upper Sections together by choosing one of the methods below:

Bare wire cable ends:

Carefully remove sufficient insulation from the cable ends, refer to figures 12, 13 & 14. If the cable is stranded, carefully twist the strands together as tightly as possible.

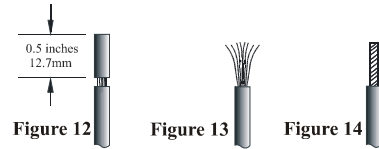

Note: If desired, the twisted ends can be tinned with solder to keep the strands together or attach spade lugs.

Spade lug or prepared wire connection:

Insert the spade lug connector or prepared section of the cable end into the terminal side access hole, and tighten the terminal cap until the cable is firmly clamped into the terminal so the wires cannot slip out. Refer to figures 15, 16 & 17.

2. Connect a 14 inch Jumper Wire from the Low

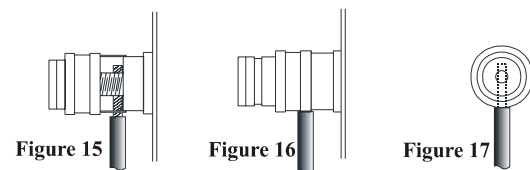

Frequency Column Upper Section (-) Binding Post to the Low Frequency Column Lower Section (-) Binding Post.

3. Connect a 14 inch Jumper Wire from the Low Frequency Column Upper Section (+) Binding Post to the Low Frequency Column Lower Section (+) Binding Post.
4. Connect a Loudspeaker cable from the XRT2K HIGH Frequency INPUTS 3 (-) Binding Post on the Low Frequency Column Lower Section to the (-) Binding Post C of the Power Amplifier number one.
5. Connect a Loudspeaker cable from the XRT2K HIGH Frequency INPUTS 3 (+) Binding Post on the Low Frequency Column Lower Section

to the (8 ohm) Binding Post C of the Power Amplifier number one.

6. Connect a Loudspeaker cable from the XRT2K MID Frequency INPUTS 2 (-) Binding Post on the Low Frequency Column Lower Section to the (-) Binding Post B of the Power Amplifier number one.
7. Connect a Loudspeaker cable from the XRT2K MID Frequency INPUTS 2 (+) Binding Post on the Low Frequency Column Lower Section to the (8 ohm) Binding Post B of the Power Amplifier number one.
6. Connect a Loudspeaker cable from the XRT2K MID Frequency INPUTS 3 (-) Binding Post on the Low Frequency Column Lower Section to the (-) Binding Post A of the Power Amplifier number one.
7. Connect a Loudspeaker cable from the XRT2K MID Frequency INPUTS 3 (+) Binding Post on the Low Frequency Column Lower Section to the (8 ohm) Binding Post A of the Power Amplifier number one.
8. Connect Loudspeaker cables from the XRT2K LOW Frequency INPUTS 3 (-) and (+) Binding Posts on the Low Frequency Column Lower Section to the (-) and (8 ohm) Binding Posts A of the Power Amplifier number two.

Note: It is important to maintain the correct polarity at both ends of the Loudspeaker cables.

9. Connect Loudspeaker cables from the XRT2K LOW Frequency INPUTS 2 (-) and (+) Binding Posts on the Low Frequency Column Lower Section to the (-) and (8 ohm) Binding Posts B of the Power Amplifier number two.
10. Connect Loudspeaker cables from the XRT2K LOW Frequency INPUTS 1 (-) and (+) Binding Posts on the Low Frequency Column Lower Section to the (-) and (8 ohm) Binding Posts C of the Power Amplifier number two.
11. Tighten all of the Loudspeaker and Amplifier Binding Posts.
12. Connect the remaining XRT2K Loudspeaker(s) and Power Amplifier Channel(s) in the same manner.

McIntosh MC2KW Power Amplifier number two

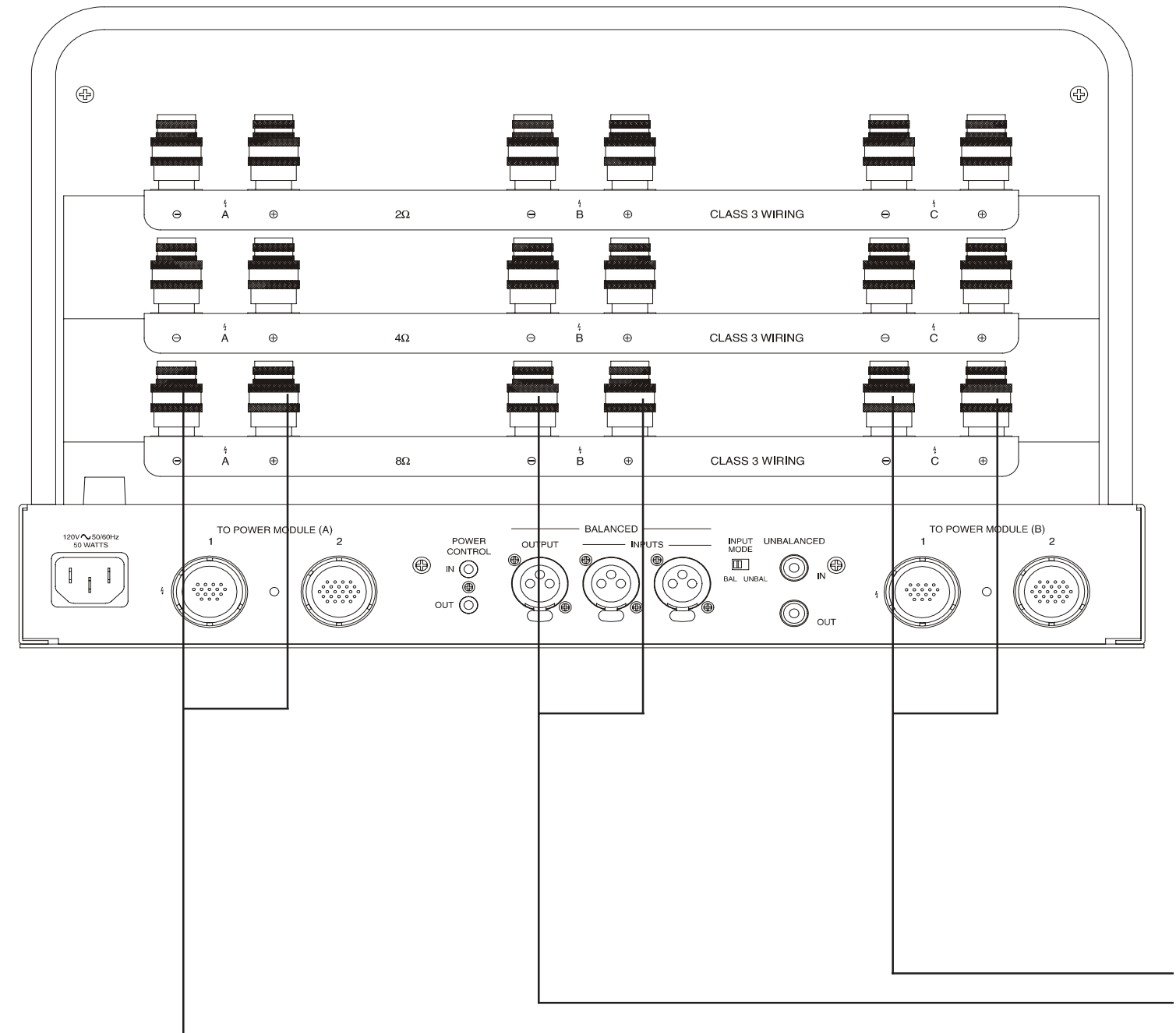

McIntosh MC2KW Power Amplifier number one

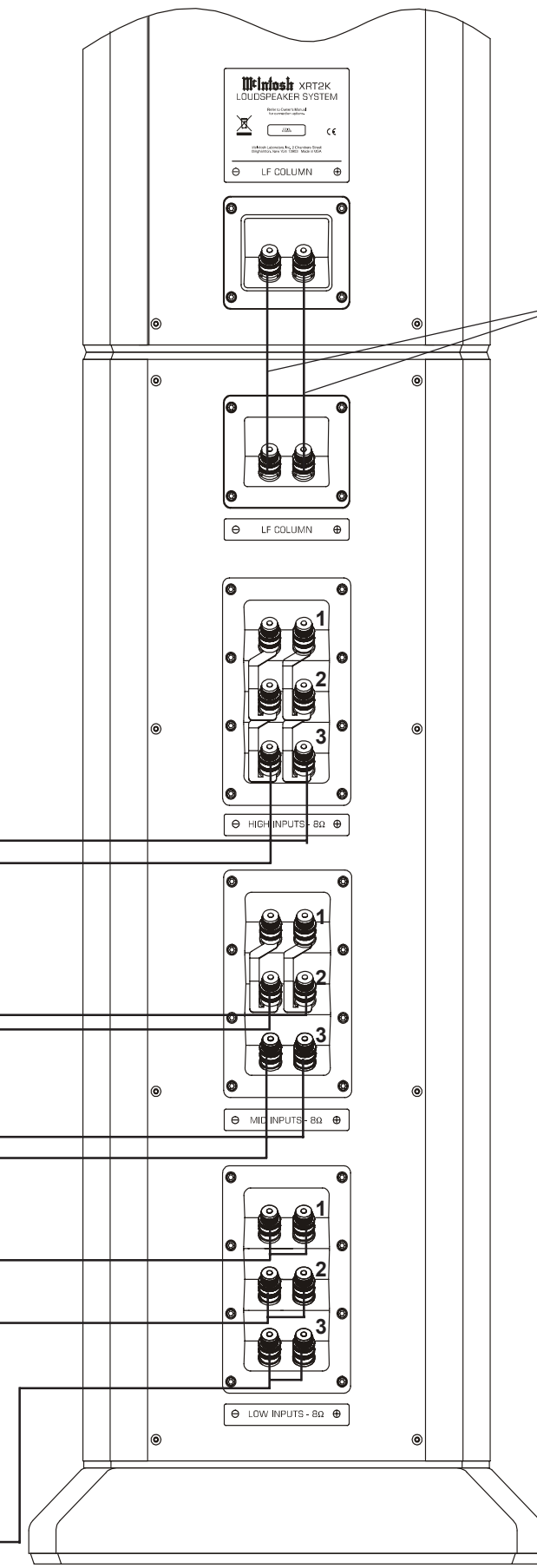
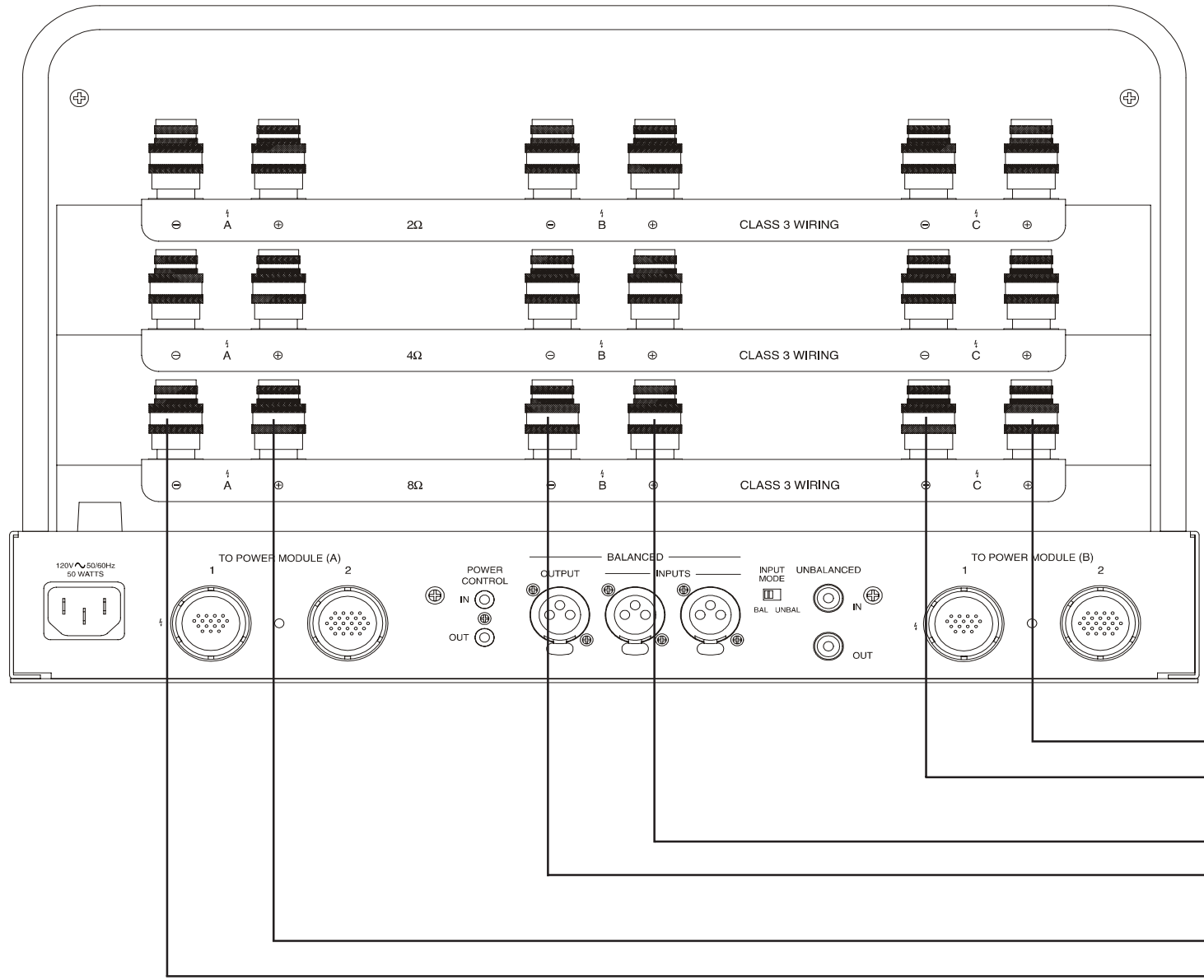

14 inch (35.6cm) Jumper Wires

How to Connect using three Amplifiers

Caution: The AC Power Cord should not be connected to the Power Amplifier until after the Loudspeaker Connections have been made. Failure to observe this could result in Electric Shock.

1. Prepare two 14 inch (35.6cm) Jumper Wires for connecting the Low Frequency Column, Lower and Upper Sections together by choosing one of the methods below:

Bare wire cable ends:

Carefully remove sufficient insulation from the cable ends, refer to figures 12, 13 & 14. If the cable is stranded, carefully twist the strands together as tightly as possible.

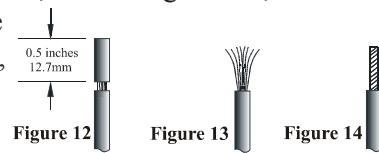

Note: If desired, the twisted ends can be tinned with solder to keep the strands together or attach spade lugs.

Spade lug or prepared wire connection:

Insert the spade lug connector or prepared section of the cable end into the terminal side access hole, and tighten the terminal cap until the cable is firmly clamped into the terminal so the wires cannot slip out. Refer to figures 15, 16 & 17.

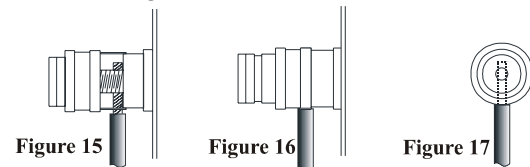

2. Connect 14 inch Jumper Wires from the Low Frequency Column Upper Section (-) and (+) Binding Posts to the Low Frequency Column Lower Section (-) and (+) Binding Posts.
3. Connect Loudspeaker cables from the XRT2K HIGH Frequency INPUTS 3 (-) and (+) Binding Posts on the Low Frequency Column Lower Section to the (-) and (8 ohm) Binding Posts A of the Power Amplifier number two.
4. Connect Loudspeaker cables from the XRT2K HIGH Frequency INPUTS 2 (-) and (+) Binding Posts on the Low Frequency Column Lower Section to the (-) and (8 ohm) Binding Posts B of the Power Amplifier number three.

5. Connect Loudspeaker cables from the XRT2K HIGH Frequency INPUTS 1 (-) and (+) Binding Posts on the Low Frequency Column Lower Section to the (-) and (8 ohm) Binding Posts C of the Power Amplifier number three.
6. Connect Loudspeaker cables from the XRT2K MID Frequency INPUTS 3 (-) and (+) Binding Posts on the Low Frequency Column Lower Section to the (-) and (8 ohm) Binding Posts A of the Power Amplifier number three.
7. Connect Loudspeaker cables from the XRT2K MID Frequency INPUTS 2 (-) and (+) Binding Posts on the Low Frequency Column Lower Section to the (-) and (8 ohm) Binding Posts B of the Power Amplifier number two.
8. Connect Loudspeaker cables from the XRT2K MID Frequency INPUTS 1 (-) and (+) Binding Posts on the Low Frequency Column Lower Section to the (-) and (8 ohm) Binding Posts C of the Power Amplifier number two.
9. Connect Loudspeaker cables from the XRT2K LOW Frequency INPUTS 3 (-) and (+) Binding Posts on the Low Frequency Column Lower Section to the (-) and (8 ohm) Binding Posts A of the Power Amplifier number one.
10. Connect Loudspeaker cables from the XRT2K LOW Frequency INPUTS 2 (-) and (+) Binding Posts on the Low Frequency Column Lower Section to the (-) and (8 ohm) Binding Posts B of the Power Amplifier number one.
11. Connect Loudspeaker cables from the XRT2K LOW Frequency INPUTS 1 (-) and (+) Binding Posts on the Low Frequency Column Lower Section to the (-) and (8 ohm) Binding Posts C of the Power Amplifier number one.
12. Tighten all of the Loudspeaker and Amplifier Binding Posts.
13. Connect the remaining XRT2K Loudspeaker(s) and Power Amplifier Channel(s) in the same manner.

McIntosh MC2KW Power Amplifier number three

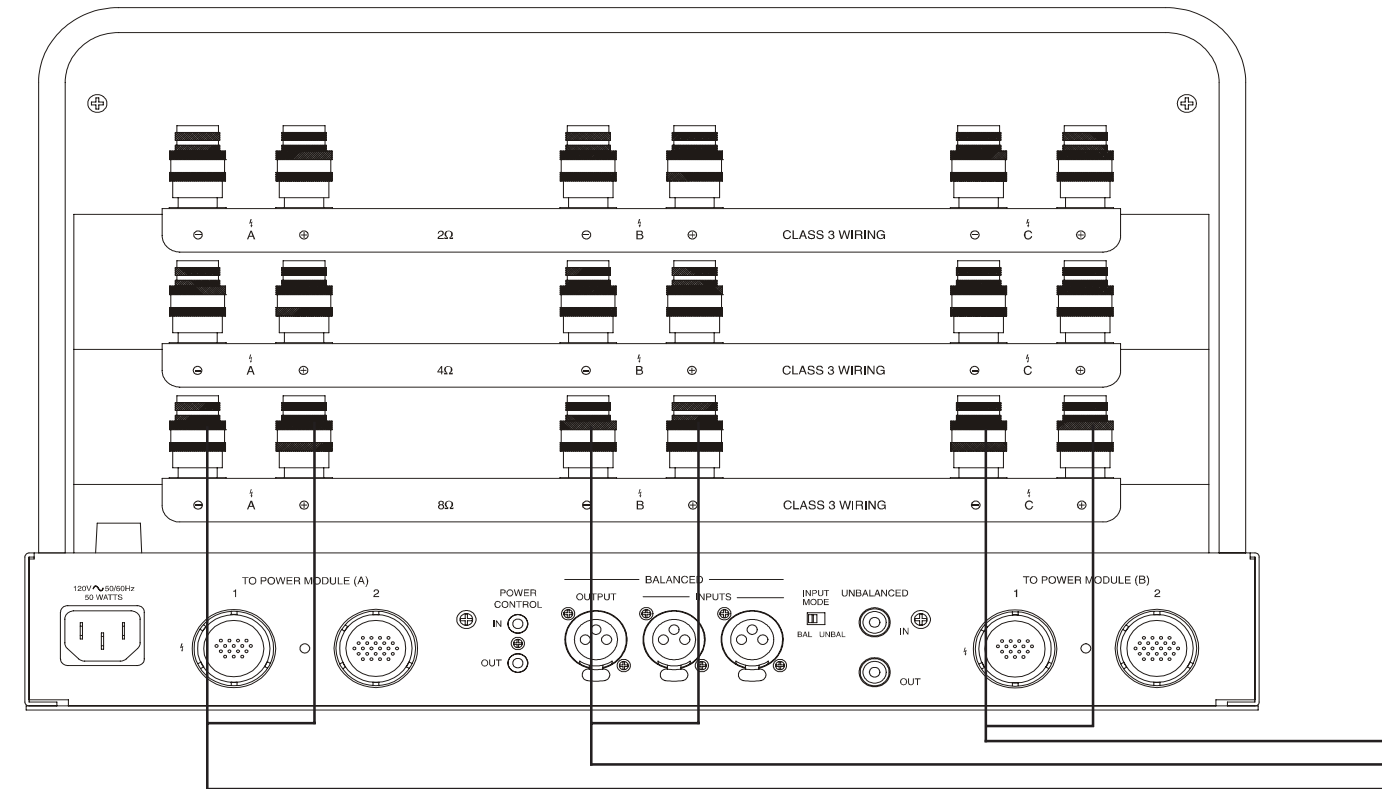

McIntosh MC2KW Power Amplifier number two

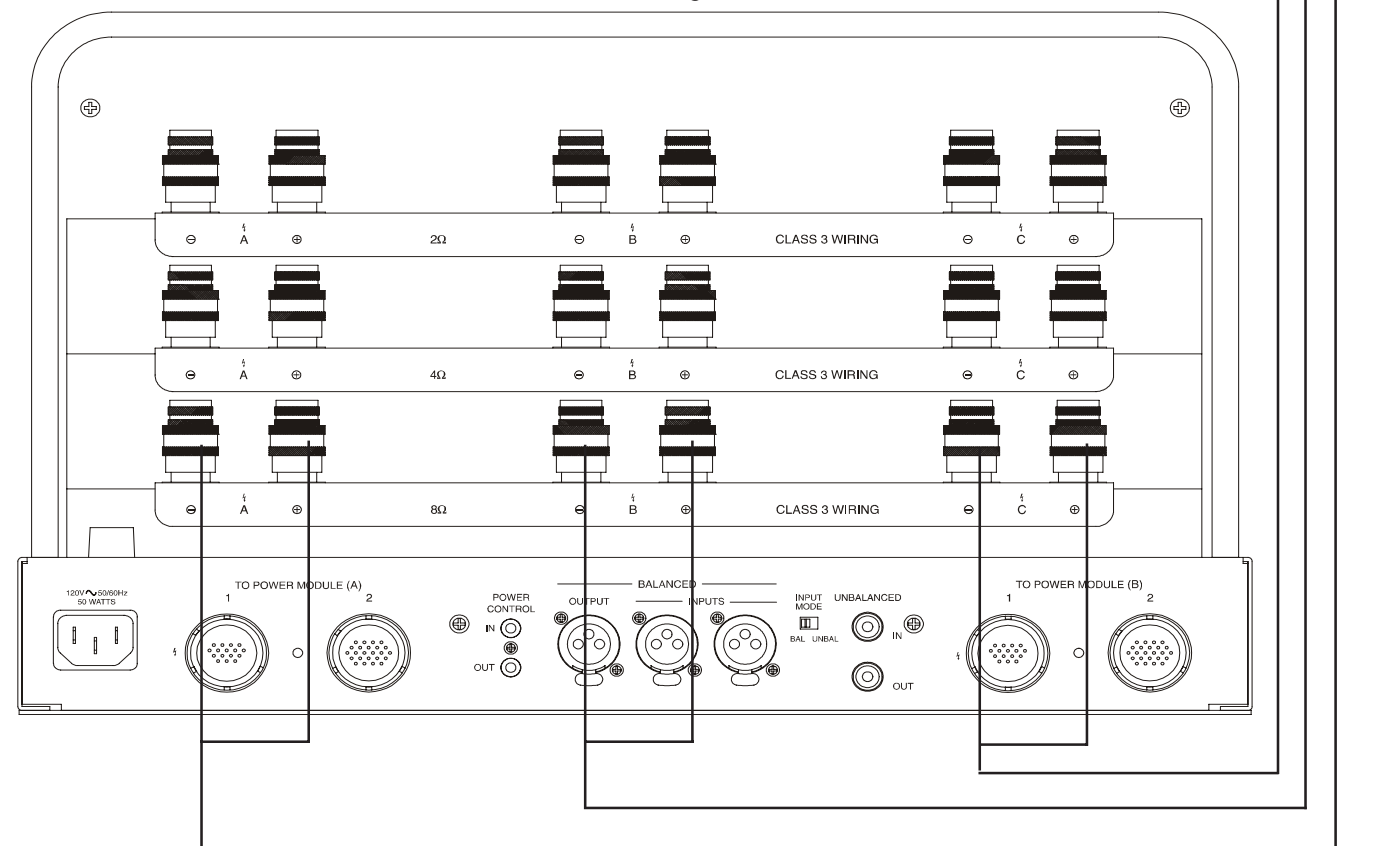

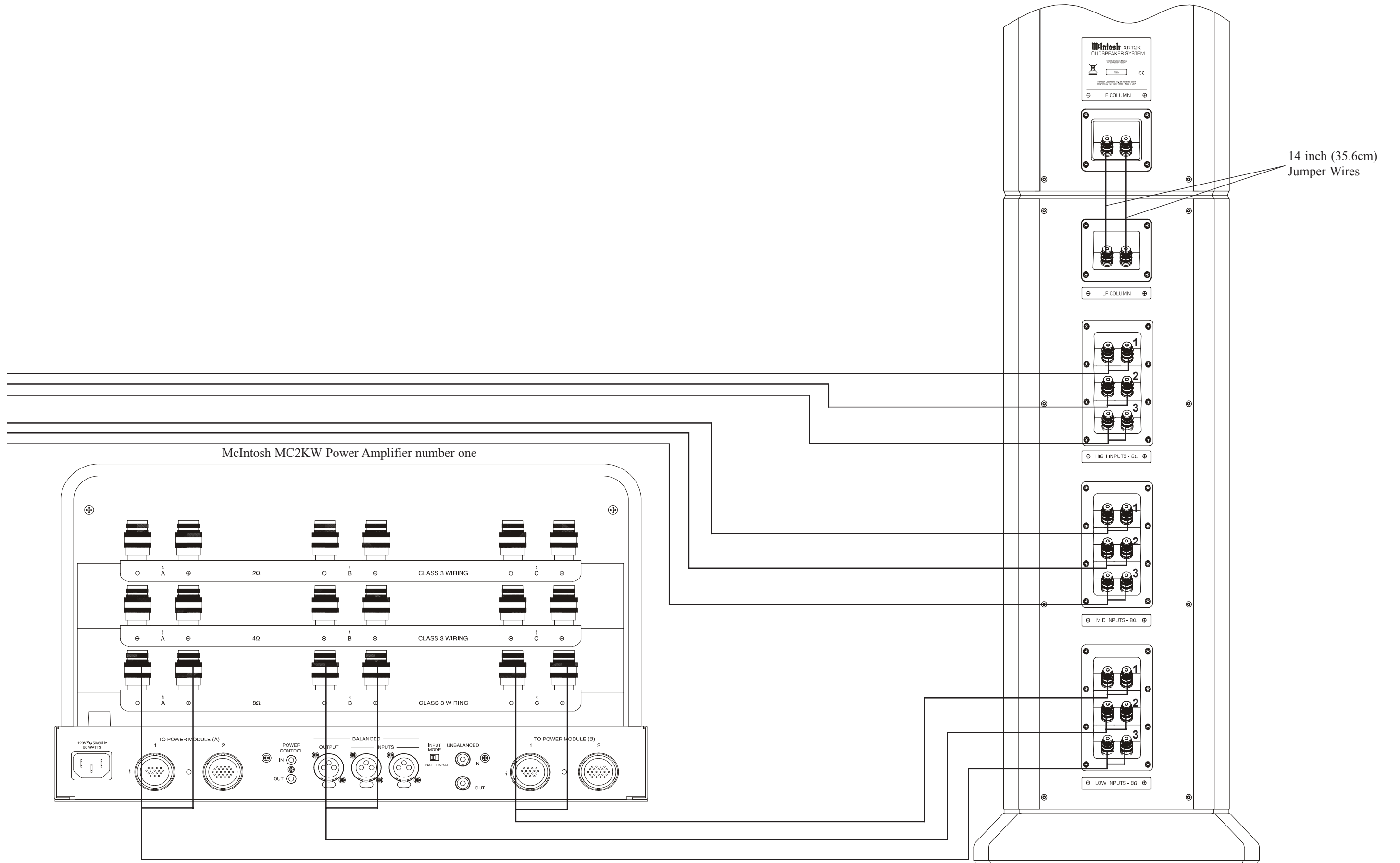



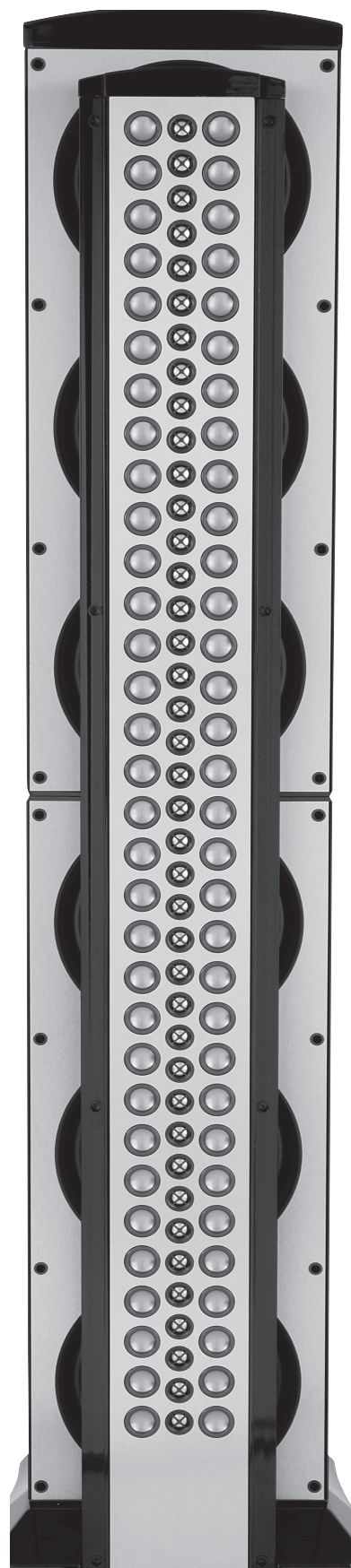

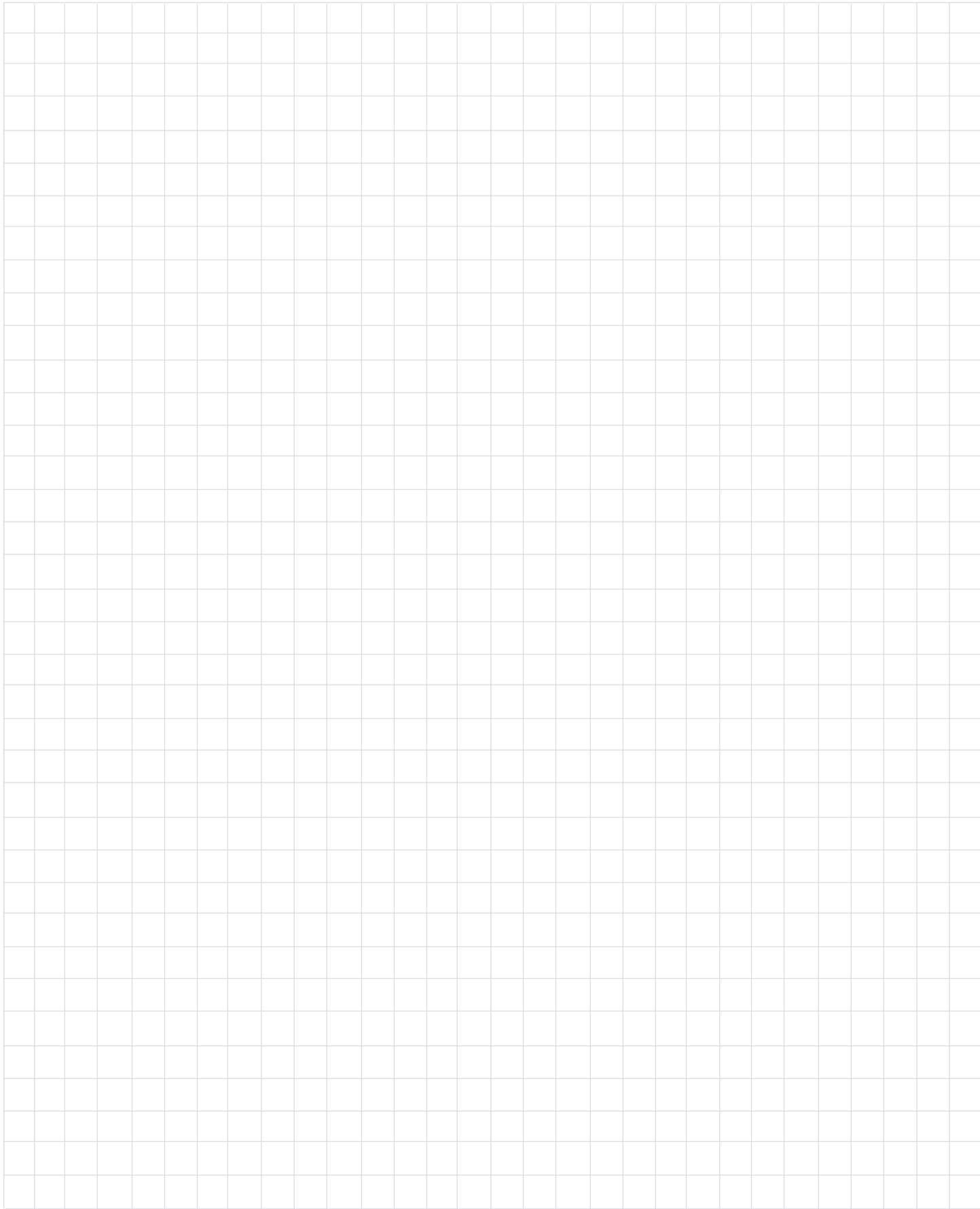

Specifications

System Driver Complement

Six 12 inch Aluminum Cone Woofers
Sixty-four 2 inch Titanium Inverted
Dome Midranges
Forty 3/4 inch Titanium Dome Tweeters

Impedance

8 ohms Nominal

Frequency Response

16Hz - 45kHz

Sensitivity

89dB (2.8V/1m equivalent)

Crossover Frequencies

250Hz
1,500Hz

Power Handling

2,000 Watts Maximum

General Specifications

Finish Enclosures

High Gloss Black Aluminum Sides, Brushed Alu-
minum Front and Back, High Gloss Black Top and
Bottom

Finish Grille

Black Knit Cloth with High Gloss Trim

Optional Wood Trim Finishes

Natural Cherry, Red Cherry or Champagne Gold
(Check with your McIntosh Dealer for Additional
Details)

Overall Dimensions

Width is 19 inches (48.26cm)
Height is 83-7/8 inches (213.04cm) including feet
Depth is 18 inches (45.72cm)

Weight

452 pounds (205.0 kg) net
522 pounds (236.8kg) in shipping carton

Packing Instructions

In the event it is necessary to repack the equipment for shipment, the equipment must be packed exactly as shown below. To protect the finish of the Columns it is advisable to place them in the original protective cotton blue covers before placing them into the shipping carton.

Use the original shipping carton and interior parts only if they are all in good serviceable condition. If a shipping carton or any of the interior part(s) are needed, please call or write Customer Service Department of McIntosh Laboratory. Please see the Part List for the correct part numbers.

XRT2K Midrange/High Frequency Column

Quantity	Part Number	Description
1	034335	Top shipping carton
1	034336	Bottom shipping carton
2	034339	Foam end cap
3	034340	Foam center cap
1	034352	Protective blue cloth cover (Column)
1	034364	Protective blue cloth cover (Low Frequency Column Grille)
	034358	Accessory box

XRT2K Low Frequency Column Lower Section

Quantity	Part Number	Description
1	034333	Top shipping carton
1	034334	Bottom shipping carton
1	034338	Base foam end cap
1	034357	Center foam support
1	034337	End foam cap
1	034365	Protective blue cloth cover, Low Frequency Column Lower Section

XRT2K Low Frequency Column Upper Section

Quantity	Part Number	Description
1	034333	Top shipping carton
1	034334	Bottom shipping carton
1	034357	Center foam support
2	034337	End foam cap
1	034353	Protective blue cloth cover, Low Frequency Column Upper Section

XRT2K Midrange/High Frequency Column Shipping Carton

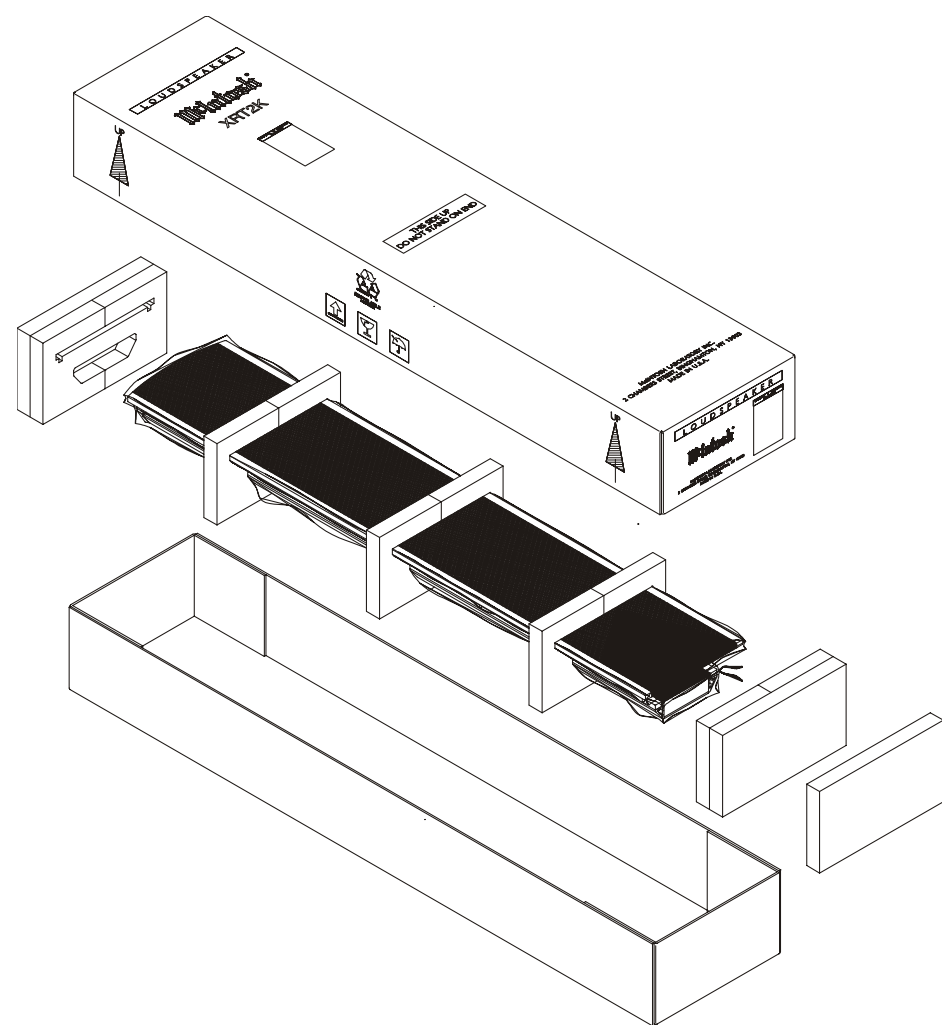

XRT2K Low Frequency Column Lower Section Shipping Carton

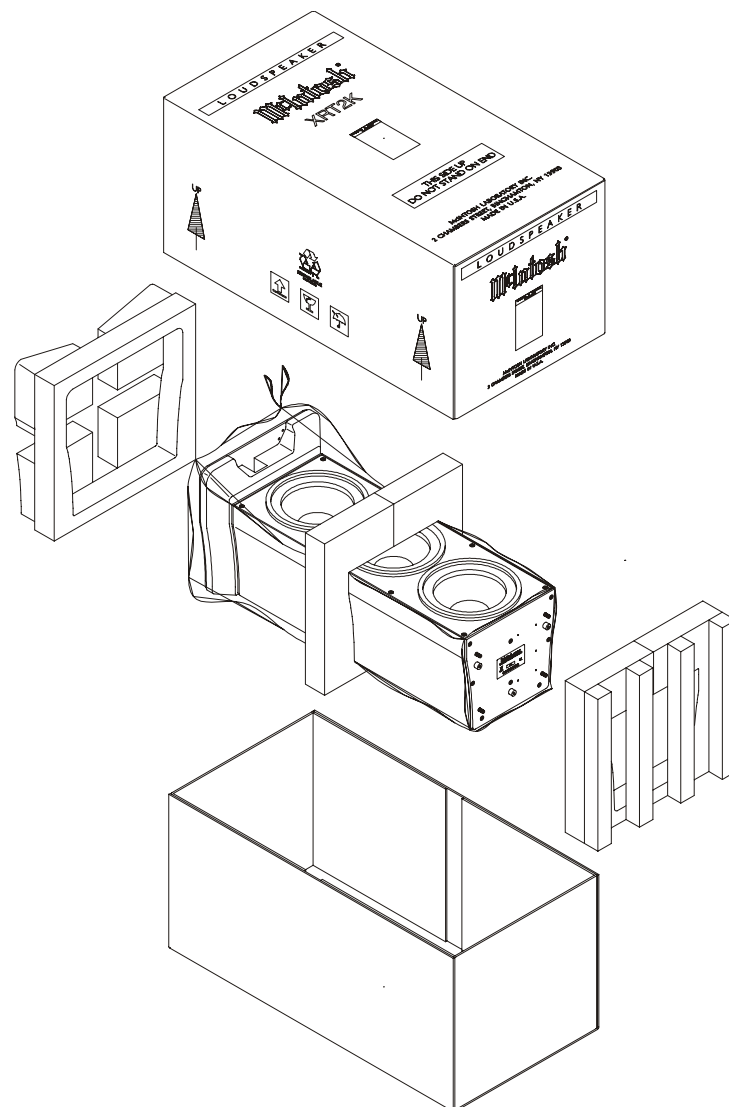

XRT2K Low Frequency Column Upper Section Shipping Carton

