

MULTIGATE® PRO XR4400

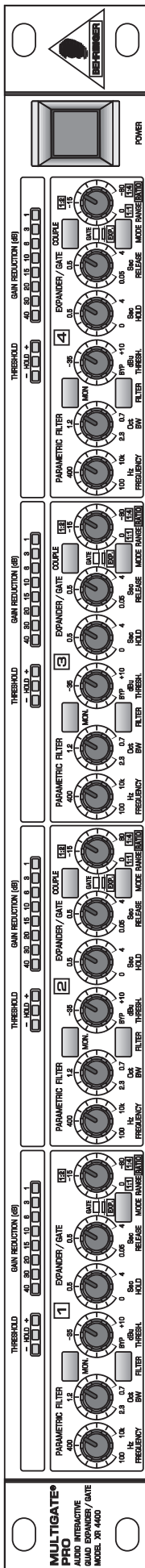

User's Manual Bedienungsanleitung

Version 1.0 June 1998

E
D



www.behringer.de



EG-Declaration of Conformity



INTERNATIONAL GmbH

acc. to the Directives 89/336/EWG and 73/23/EWG

We,

BEHRINGER INTERNATIONAL GmbH

Hanns-Martin-Schleyer-Straße 4

D - 47877 Willich

Name and address of the manufacturer or the introducer of the product on the market who is established in the EC

herewith take the sole responsibility to confirm that the product:

MULTIGATE PRO XR4400

Type designation and, if applicable, Article-N°

which refers to this declaration, is in accordance with the following standards or standardized documents:

EN 60065

EN 61000-3-2

EN 55020

EN 61000-3-3

EN 55013

The following operation conditions and installation arrangements have to be presumed:

acc. to Operating Manual

BEHRINGER
INTERNATIONAL GmbH
Hanns-Martin-Schleyer-Str. 36-38
D-47877 Willich, Mercurstraße II
Tel.-Nr. 0 21 54 / 92 06-0
Fax-Nr. 0 21 54 / 92 06-30

B. Nier, President

Willich, 01.06.1998

Name, address, date and legally binding signature of the person responsible

SAFETY INSTRUCTIONS

CAUTION: To reduce the risk of electrical shock, do not remove the cover (or back). No user serviceable parts inside; refer servicing to qualified personnel.



WARNING: To reduce the risk of fire or electrical shock, do not expose this appliance to rain or moisture.



This symbol, wherever it appears, alerts you to the presence of uninsulated dangerous voltage inside the enclosure - voltage that may be sufficient to constitute a risk of shock.



This symbol, wherever it appears, alerts you to important operating and maintenance instructions in the accompanying literature. Read the manual.

DETAILED SAFETY INSTRUCTIONS:

All the safety and operation instructions should be read before the appliance is operated.

Retain Instructions:

The safety and operating instructions should be retained for future reference.

Heed Warnings:

All warnings on the appliance and in the operating instructions should be adhered to.

Follow instructions:

All operation and user instructions should be followed.

Water and Moisture:

The appliance should not be used near water (e.g. near a bathtub, washbowl, kitchen sink, laundry tub, in a wet basement, or near a swimming pool etc.).

Ventilation:

The appliance should be situated so that its location or position does not interfere with its proper ventilation. For example, the appliance should not be situated on a bed, sofa rug, or similar surface that may block the ventilation openings: or placed in a built-in installation, such as a bookcase or cabinet that may impede the flow of air through the ventilation openings.

Heat:

The appliance should be situated away from heat sources such as radiators, heat registers, stoves, or other appliance (including amplifiers) that produce heat.

Power Source:

The appliance should be connected to a power supply only of the type described in the operating instructions or as marked on the appliance.

Grounding or Polarization:

Precautions should be taken so that the grounding or polarization means of an appliance is not defeated.

Power-Cord Protection:

Power supply cords should be routed so that they are not likely to be walked on or pinched by items placed upon or against them, paying particular attention to cords and plugs, convenience receptacles and the point where they exit from the appliance.

Cleaning:

The appliance should be cleaned only as recommended by the manufacturer.

Non-use Periods:

The power cord of the appliance should be unplugged from the outlet when left unused for a long period of time.

Object and Liquid Entry:

Care should be taken so that objects do not fall and liquids are not spilled into the enclosure through openings.

Damage Requiring Service:

The appliance should be serviced by qualified service personnel when:

- The power supply cord or the plug has been damaged; or
- Objects have fallen, or liquid has been spilled into the appliance; or
- The appliance has been exposed to rain; or
- The appliance does not appear to operate normally or exhibits a marked change in performance; or
- The appliance has been dropped, or the enclosure damaged.

Servicing:

The user should not attempt to service the appliance beyond that is described in the Operating Instructions. All other servicing should be referred to qualified service personnel.



MULTIGATE PRO

Audio Interactive 4-channel Expander/Gate of the high-end class

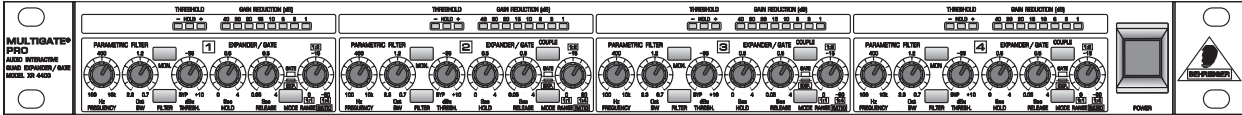

- ▲ High-precision Parametric Filter for frequency selective operation
- ▲ UTR (Ultra Transient Response) selectable ultra-fast Gate
- ▲ IRC (Interactive Ratio Control) selectable ultra-smooth Expander
- ▲ Fully adjustable Ratio control in Expander mode
- ▲ Fully adjustable Attenuation control in Gate mode
- ▲ Independent Hold/Release controls for any envelope shaping
- ▲ FlexLink system for flexible Master/Slave configurations
- ▲ Filter Monitor facility for monitoring the filter section
- ▲ High-performance VCAs on all channels
- ▲ Ultra-low noise 4580 audio operational amplifiers for outstanding sound performance
- ▲ Precise 8-segment metering for Gain Reduction
- ▲ Accurate “Traffic Light” display for easy Threshold setting
- ▲ True RMS level detection for “inaudible” performance
- ▲ Servo-balanced gold-plated XLR and 1/4” TRS inputs and outputs
- ▲ High-quality detented potentiometers and illuminated switches
- ▲ Manufactured under the stringent ISO9000 management system

EXPANDER
GATE
4
00

FOREWORD

Dear Customer,

Welcome to the team of MULTIGATE PRO users and thank you very much for expressing your confidence in BEHRINGER products by purchasing this unit.

It is one of my most pleasant tasks to write this letter to you, because it is the culmination of many months of hard work delivered by our engineering team to reach a very ambitious goal: making an outstanding device better still. The MULTIGATE has for quite a long time been a standard tool used by numerous studios and P.A. rental companies. The task to improve one of our best-selling products certainly meant a great deal of responsibility, which we assumed by focusing on you, the discerning user and musician. It also meant a lot of work and night shifts to accomplish this goal. But it was fun, too. Developing a product usually brings a lot of people together, and what a great feeling it is when everybody who participated in such a project can be proud of what we've achieved.

It is our philosophy to share our joy with you, because you are the most important member of the BEHRINGER family. With your highly competent suggestions for new products you've greatly contributed to shaping our company and making it successful. In return, we guarantee you uncompromising quality (manufactured under ISO9000 certified management system) as well as excellent technical and audio properties at an extremely favorable price. All of this will enable you to fully unfold your creativity without being hampered by budget constraints.

We are often asked how we can make it to produce such high-grade devices at such unbelievably low prices. The answer is quite simple: it's you, our customers! Many satisfied customers means large sales volumes enabling us to get better conditions of purchase for components, etc. Isn't it only fair to pass this benefit back to you? Because we know that your success is our success, too!

I would like to thank all people whose help on "Project MULTIGATE PRO" has made it all possible. Everybody has made very personal contributions, starting from the designers of the unit via the many staff members in our company to you, the user of BEHRINGER products.

My friends, it's been worth the trouble!

Thank you very much,

A handwritten signature in black ink, appearing to read 'U. Behringer', with a long horizontal flourish extending to the right.

Uli Behringer



TABLE OF CONTENT

1. INTRODUCTION	7
1.1 Technical background	8
1.1.1 Noise as a physical phenomenon	8
1.1.2 What are audio dynamics?	8
1.1.3 Compressors/limiters	9
1.1.4 Expanders/noise-gates	10
2. THE DESIGN CONCEPT	10
2.1 High quality components and design	10
2.2 Inputs and outputs	11
2.2.1 Balanced inputs and outputs	11
3. INSTALLATION	11
3.1 Rack mounting	11
3.2 Mains voltage	11
3.3 Audio connections	11
4. CONTROLS	13
4.1 The front panel control elements	13
4.2 The rear panel elements	14
5. TECHNICAL BACKGROUND	15
5.1 EXPANDER mode	15
5.2 Interactive control functions	15
5.2.1 THRESHOLD control	15
5.2.2 Attack, release and hold times	16
5.2.3 IAC circuit (Interactive Attack Control)	16
5.2.4 RANGE function	16
5.2.5 IRC circuit (Interactive Ratio Control)	17
5.2.6 RATIO function	17
5.3 FLEXLINK function	17
5.4 The SIDE-CHAIN filter	18
5.4.1 The MONITOR function	18
6. APPLICATIONS	18
6.1 Basic setting	18
6.1.1 The gate function	18
6.1.2 The expander function	20
6.2 Proper positioning of microphones	20
6.3 Applications	20
6.3.1 Suppressing crosstalk in multi-track applications	20
6.3.2 Reducing crosstalk in stage microphones	21
6.3.3 Reducing feedback in stage microphones	21
7. SPECIFICATIONS	21
8. WARRANTY	23

1. INTRODUCTION

With the BEHRINGER MULTIGATE PRO you purchased a dynamics processor of the high-end class designed to meet highest requirements: professional recording, broadcast and television studios, CD and digital production facilities, etc. Its complete range of features and innovative circuit topology make the MULTIGATE PRO an all-purpose device for reducing noise in audio recordings, for automatically muting stage mics, expanding the dynamic range of compressed recordings, improving the signal-to-noise ratio of noisy communications systems and for producing special effects, etc.

Future-oriented BEHRINGER technology

Our MULTIGATE range of devices has been a hit ever since we introduced our first model several years ago. This expander/gate is based on many years of experience and findings in psychoacoustics and is used throughout the world in renowned studios, sound reinforcement systems as well as in broadcast and television studios.

It was a real challenge to improve the well-known MULTIGATE even further, and we are proud of our success. Compared to its predecessor models, the MULTIGATE PRO not only has additional features, but also comes with dramatically improved functionalities. For example, it now has a parametric filter enabling you to accurately set the trigger frequencies, while the FlexLink system allows for great flexibility when linking the device's individual channels in a master/slave configuration.

Basically, quadruple gates are not a new invention. However, packing four simple noise gates into one enclosure usually means a compromise in terms of ease of operation and functionality. Too many control elements make such a device impossible to handle, and if you sacrifice crucial functions for the sake of easy operation, the range of useful applications is restricted considerably.

The BEHRINGER MULTIGATE PRO is a quadruple expander/gate with a maximum of functionalities and can still be operated conveniently. Interactive functions make it easy and efficient to specifically process any kind of program material, while the need for "adjustment work" has been reduced drastically. Each of the MULTIGATE PRO's four sections comprises an ultra-fast gate, a program-dependent expander, a filter section and high-precision meters indicating both threshold point and gain reduction.

The IAC circuit (Interactive Attack Control)

One of the MULTIGATE PRO's most outstanding features is the program-dependent control of attack times. The new IAC circuit (Interactive Attack Control) analyzes the program material to calculate the attack time by way of interaction, so that the hold/release process is triggered automatically depending on the program, which is why the MULTIGATE PRO does not need a dedicated attack control.

Switchable gate/expander function

Another highlight of the MULTIGATE PRO is the switchable operating mode of gate and expander. With the MODE function off, the MULTIGATE PRO works in gate mode using an extremely fast attack time to gate all kinds of drum and synthesizer sounds, without cutting their percussive edge.

In expander mode the device analyzes the shape and dynamic contents of the input signal to calculate the control time parameters. It thus works as an interactive expander that adapts automatically to the program signal. The result: guitar sounds, vocals and complex mix signals can be "cleaned" without audible clicks, breathing or other detrimental effects. Additionally, you can freely expand any type of program material in its dynamic range.

Side-chain filter section

When several microphones are used, for example to pick up a drum set, crosstalk between microphones can lead to unwanted triggering of the gate. The built-in parametric side-chain filter of the MULTIGATE PRO allows the user to accurately select the frequencies causing the trouble, so that the device responds to these frequencies only. The monitor function can be used to pre-monitor the filter, making it easier to adapt the circuitry to the acoustic properties of the program material.

FlexLink system

An innovative couple function gives you great flexibility to synchronize the expander/gate sections in a master/slave configuration.





The following operational manual will introduce you to the BEHRINGER MULTIGATE PRO and its various functions. After reading the manual carefully, make sure it is always on hand for future reference.

1.1 Technical background

By employing current modern analog technology it is possible to manufacture audio equipment with a dynamic range of up to 130 dB. In contrast to analog techniques, the dynamic range of digital equipment is approximately 25 dB less. With conventional record and tape recorder technology, as well as broadcasting, this value is further reduced. Generally, dynamic restrictions are due to noisy storage in transmission media and also the maximum headroom of these systems.

1.1.1 Noise as a physical phenomenon

All electrical components produce a certain level of inherent noise. Current flowing through a conductor leads to uncontrolled random electron movements. For statistical reasons, this produces frequencies within the whole audio spectrum. If these currents are highly amplified, the result will be perceived as noise. Since all frequencies are equally affected, we term this *white* noise. It is fairly obvious that electronics cannot function without components. Even if special low-noise components are used, a certain degree of basic noise cannot be avoided.

This effect is similar when replaying a tape. The non-directional magnetic particles passing the replay head can also cause uncontrolled currents and voltages. The resulting sound of the various frequencies is heard as noise. Even the best possible tape biasing can “only” provide signal-to-noise ratios of about 70 dB, which is not acceptable today since the demands of listeners have increased. Due to the laws of physics, improving the design of the magnetic carrier is impossible using conventional means.

1.1.2 What are audio dynamics?

A remarkable feature of the human ear is that it can detect the most wide ranging amplitude changes - from the slightest whisper to the deafening roar of a jet-plane. If one tried to record or reproduce this wide spectrum of sound with the help of amplifiers, cassette recorders, records or even digital recorders (CD, DAT etc.), one would immediately be restricted by the physical limitations of electronic and acoustic sound reproduction technology.

The usable dynamic range of electro-acoustic equipment is limited as much at the low end as at the high end. The thermal noise of the electrons in the components results in an audible basic noise floor and thus represents the bottom limit of the transmission range. The upper limit is determined by the levels of the internal operating voltages; if they are exceeded, audible signal distortion is the result. Although in theory, the usable dynamic range sits between these two limits, it is considerably smaller in practice, since a certain reserve must be maintained to avoid distortion of the audio signal if sudden level peaks occur. Technically speaking, we refer to this reserve as “headroom” - usually this is about 10 - 20 dB. A reduction of the operating level would allow for greater headroom, i.e. the risk of signal distortion due to level peaks would be reduced. However, at the same time, the basic noise floor of the program material would be increased considerably.

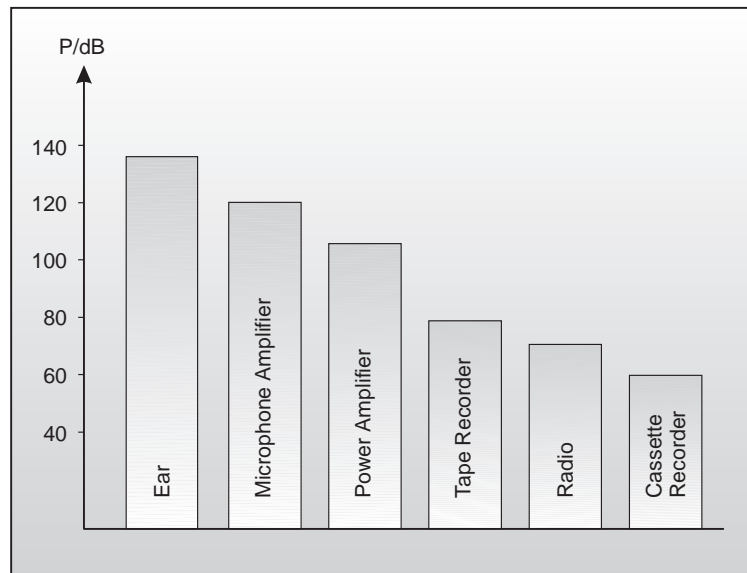

Fig. 1.1: The dynamic range capabilities of various devices

It is therefore useful to keep the operating level as high as possible without risking signal distortion in order to achieve optimum transmission quality.

It is possible to further improve the transmission quality by constantly monitoring the program material with the aid of a volume fader, which manually levels the material. During low passages the gain is increased, during loud passages the gain is reduced. Of course it is fairly obvious that this kind of manual control is rather restrictive; it is difficult to detect signal peaks and it is almost impossible to level them out. Manual control is simply not fast enough to be satisfactory.

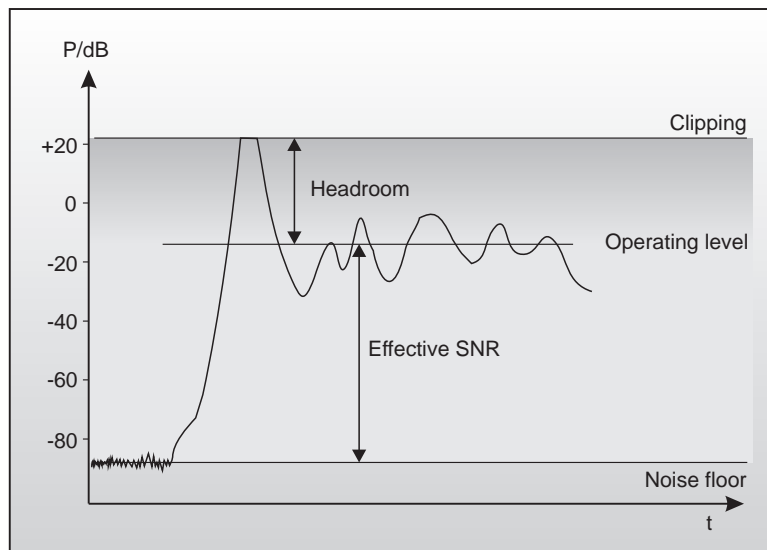

Fig. 1.2: The interactive relationship between the operating level and the headroom

The need therefore arises for a fast acting automatic gain control system which will constantly monitor the signals and which will always adjust the gain to maximize the signal-to-noise ratio without incurring signal distortion. This device is called a compressor or limiter.

1.1.3 Compressors/limiters

By measuring the dynamic range of musical instruments in live recording situations, you will find that extreme amplitudes occur which often lead to overload in subsequent signal processing equipment. Especially in broadcasting and record cutting techniques, these signal peaks can lead to heavy distortion. To avoid this kind

of distortion or, for example, to avoid loudspeakers being damaged by overload, Compressors or Limiters are used.

The principal function used in these devices is dependent on an automatic gain control as mentioned in the previous section, which reduces the amplitude of loud passages and therefore restricts the original dynamics to a desired range. This application is particularly useful in microphone recording techniques, to compensate for level changes which are caused by varying microphone distances. Although compressors and limiters perform similar tasks, one essential point makes them different: Limiters abruptly limit the signal above a certain level, while compressors control the signal "gently" over a wider range. A limiter continuously monitors the signal and intervenes as soon as the level exceeds a user-adjustable threshold. Any signal exceeding this threshold will be immediately returned to the adjusted level.

A Compressor also monitors the program material continuously and has a certain threshold level. With compression, in contrast to the action of a limiter, signals are not reduced in level abruptly once the threshold has been exceeded, but are returned to the threshold gradually. The signal is reduced in gain, relative to the amount the signal exceeds this point.

Generally, threshold levels for compressors are set below the normal operating level to allow for the upper dynamics to be musically compressed. For limiters, the threshold point is set above the normal operating level in order to provide reliable signal limiting, to protect subsequent equipment from signal overload.

1.1.4 Expanders/noise-gates

Audio, in general, is only as good as the source from which it was derived. The dynamic range of signals will often be restricted by noise. Synthesizers, effects devices, guitar pickups, amplifiers etc. generally produce a high level of noise, hum or other ambient background hiss, which can disturb the quality of the program material.

Normally these noises are inaudible if the level of the desired signal lies significantly above the level of the noise. This perception by the ear is based on the "masking" effect: noise will be masked and thus becomes inaudible as soon as considerably louder sound signals in the same frequency band are added. Nevertheless, the further the level that the desired signal decreases, the more the noise floor becomes a disturbing factor. Expanders or noise-gates offer a solution for this problem: these devices attenuate signals when their amplitudes drop, thereby fading out the background noise. Relying on this method, gain controlling amplifiers, like expanders, can extend the dynamic range of a signal and are therefore the opposite of a compressor.

In practice, it is shown that an expansion over the entire dynamic range is not desired. With an expansion ratio of 1:5 and a processed dynamic range of 30 dB, an output dynamic range of 150 dB will be the result, exceeding all subsequent signal processors, as well as human hearing. Therefore, the amplitude control is restricted to signals whose levels are below a certain threshold. Signals above this threshold pass through the unit unchanged. Due to the continuous attenuation of the signals below this threshold, this kind of expansion is termed "downward" expansion.

The noise-gate is the simplest form of an expander: in contrast to the expander, which continuously attenuates a signal below the threshold, the noise-gate cuts off the signal abruptly. In most applications this method is not very useful, since the on/off transition is too drastic. The onset of a simple gate function appears very obvious and unnatural. To achieve inaudible processing of the program material, it is necessary to be able to control the signal's envelope parameters.

2. THE DESIGN CONCEPT

2.1 High quality components and design

The philosophy behind BEHRINGER products guarantees a no-compromise circuit design and employs the best choice of components. The operational amplifiers NJM4580 which are used in the MULTIGATE PRO, are exceptional. They boast extreme linearity and very low distortion characteristics. To complement this design the choice of components includes high tolerance resistors and capacitors, detent potentiometers and several other stringently selected elements.

For the first time, the MULTIGATE PRO XR4400 uses SMD technology (Surface Mounted Device). These sub-miniature components known from aerospace technology allow for an extreme packing density, plus the unit's reliability could be improved. Additionally, the unit is manufactured in compliance with a ISO9000 certified

management system.

2.2 Inputs and outputs

2.2.1 Balanced inputs and outputs

As standard, the BEHRINGER MULTIGATE PRO is installed with electronically servo-balanced inputs and outputs. The new circuit design features automatic hum and noise reduction for balanced signals and thus allows for trouble-free operation, even at high operating levels. Externally induced mains hum etc. will be effectively suppressed. The automatic servo-function recognizes the presence of unbalanced connectors and adjusts the nominal level internally to avoid level differences between the input and output signals (correction 6 dB).



3. INSTALLATION

Your BEHRINGER MULTIGATE PRO was carefully packed in the factory and the packaging was designed to protect the unit from rough handling. Nevertheless, we recommend that you carefully examine the packaging and its contents for any signs of physical damage, which may have occurred in transit.

 **If the unit is damaged, please do not return it to us, but notify your dealer and the shipping company immediately, otherwise claims for damage or replacement may not be granted. Shipping claims must be made by the consignee.**

3.1 Rack mounting

The BEHRINGER MULTIGATE PRO fits into one standard 19" rack unit of space (1 3/4"). Please allow at least an additional 4" depth for the connectors on the back panel. Be sure that there is enough air space around the unit for cooling and please do not place the MULTIGATE PRO on high temperature devices such as power amplifiers etc. to avoid overheating.

3.2 Mains voltage

Before you connect your MULTIGATE PRO to the mains, please make sure that your local voltage matches the voltage required by the unit! The fuse holder on the female mains connector has 3 triangular markers, with two of these triangles opposing each other. Your MULTIGATE PRO is set to the operating voltage printed next to these markers, and can be set to another voltage by turning the fuse holder by 180°. **CAUTION: this instruction does not apply to export models exclusively designed, e.g. for 115 V operation!**

3.3 Audio connections

The audio inputs and outputs on the BEHRINGER MULTIGATE PRO are fully balanced. If possible, connect the unit to other devices in a balanced configuration to allow for maximum interference immunity.

 **Please ensure that only qualified persons install and operate the MULTIGATE PRO. During installation and operation the user must have sufficient electrical contact to earth. Electrostatic charges might affect the operation of the MULTIGATE PRO!**

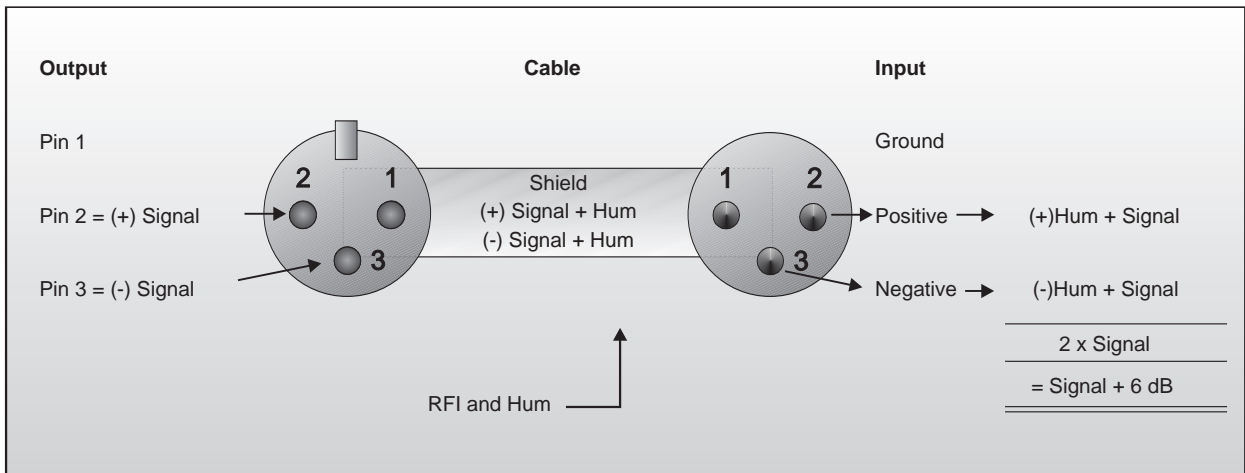

Fig. 3.1: Compensation of interference with balanced connections

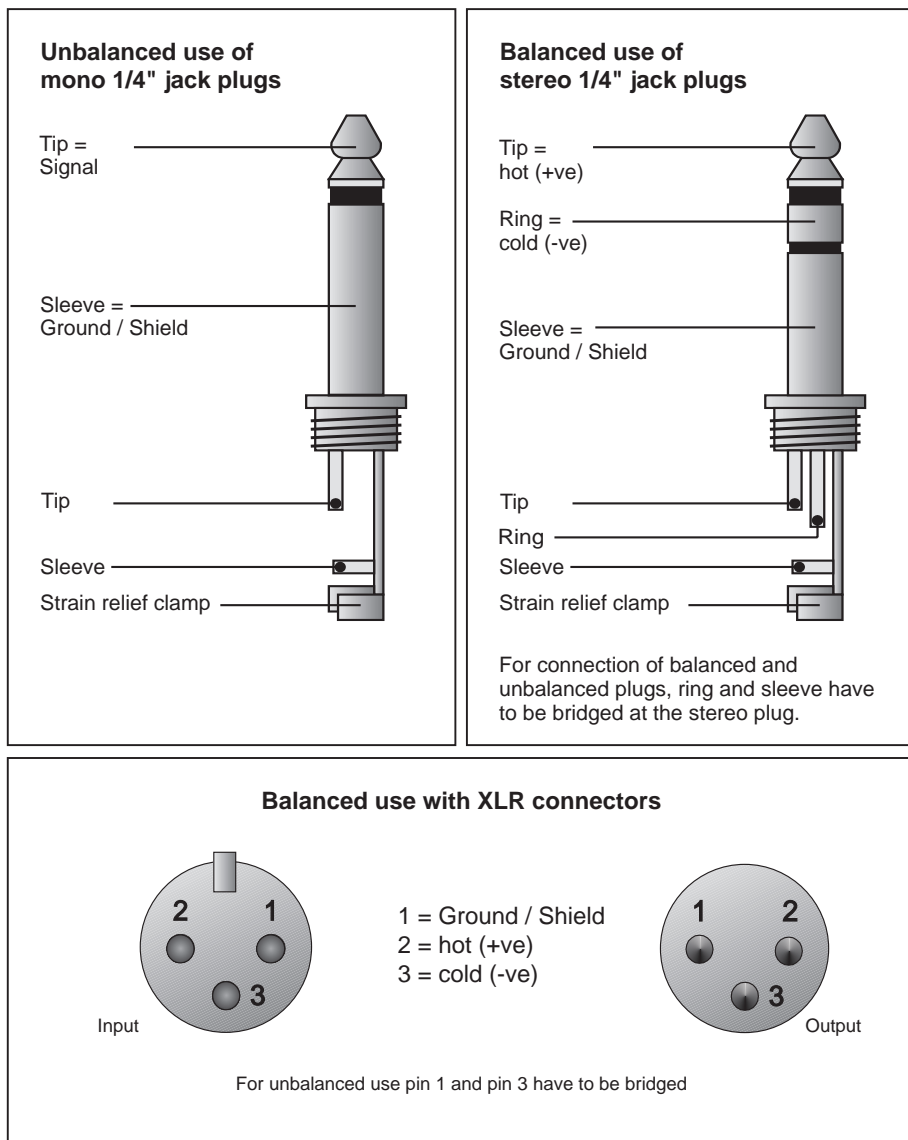

Fig. 3.2: Different plug types

 **Never use unbalanced XLR connections with microphone cables, as this would short-circuit any phantom power transmitted over these cables!**

4. CONTROLS

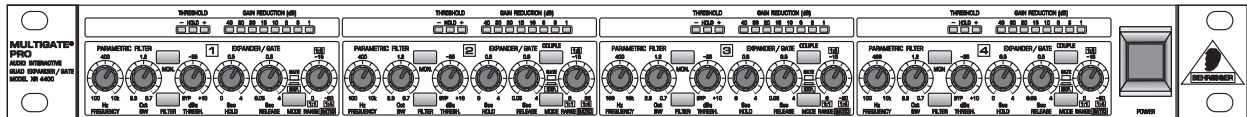

Fig. 4.1: MULTIGATE PRO front panel

The BEHRINGER MULTIGATE PRO has four channels. Each of these channels is equipped with 3 or 4 push-buttons, 6 rotary controls and 11 LEDs.

4.1 The front panel control elements

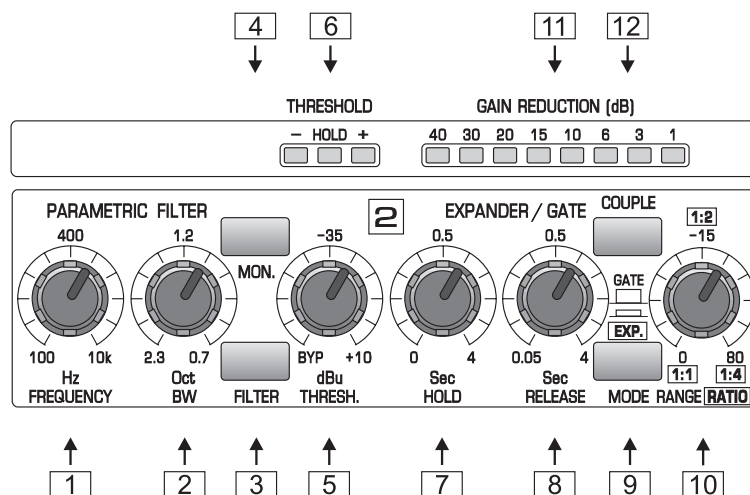



Fig. 4.2: Control elements on the front panel

- 1 The *FREQUENCY* control determines the lower limit frequency of the side-chain filter, and covers a range from 100 Hz to 10 kHz.
 - 2 The *BANDWIDTH* control determines the slope or bandwidth of the side-chain filter. The bandwidth can be set within a range from 2.3 to 0.7 octaves, so as to realize even extremely narrow-band filter settings.
 - 3 The *FILTER* control activates the parametric side-chain filter. To edit this filter there you can use the frequency and BW control.
 - 4 The *MONITOR* switch establishes a link between the side-chain control signal and the audio output. As it also mutes the audio input signal the user can pre-monitor the parametric filter output, which makes it easier to tune the filter by ear.
-  **Please note that the MONITOR switch disables the channel's audio signal.**
- 5 Use the *THRESHOLD* control to set the threshold point of the expander/gate function within a range from BYPASS to +10 dBu. Signals below the threshold are reduced in level. When the signal drops below the threshold, the hold/release function starts reducing the signal to a level adjustable with the *RANGE/RATIO* control.

 Please note that the **MULTIGATE PRO** enters bypass mode, when the **THRESHOLD** control is set to its left stop position, i.e. all processing functions are disabled and the signal is routed directly from the input to the output.

6 This “traffic light” LED chain shows the current operating mode of the unit: the “-” LED (red) indicates that the side-chain signal is below the threshold, the **HOLD** LED (yellow) informs you that the hold circuit/ release process has been activated, while the “+” LED (green) shows that the side-chain signal is above the threshold.

7 The **HOLD** control determines the delay applied to the starting point of the release process, after the signal has dropped below the threshold. The setting range is 0 to 4 seconds.

 **The HOLD control is enabled in GATE mode only!**

8 The **RELEASE** control determines the time of the release process. This process begins after the end of the hold phase and ends when the gain reduction adjusted with the **RANGE** control is achieved. The setting range of the **RELEASE** control is from 0.05 to 4 seconds.

 **The RELEASE control is enabled in GATE mode only!**

9 The **MODE** switch is used to set the operating mode of the respective channel. When the switch is out, the corresponding section works as an ultra-fast gate. In this mode, even percussive signals can be processed without any signal loss. With the **MODE** function on, the **IRC** expander (Interactive Ratio Control) is activated. This interactive control function allows for the program-dependent expansion of complex signals. Both the attack time and the fade-out characteristics (ratio) vary depending on the program material. The agreeable results of this automatic process are less critical adjustment work and “inaudible” expansion of the program material.

10 The **RANGE/RATIO** control performs a dual function: depending on the position of the **MODE** switch (i.e. depending on the operating mode of the unit: gate or expander), the **RANGE/RATIO** control determines the maximum amount of gain reduction or the expansion curve. In gate mode, this control adjusts the **RANGE** determining the amount of maximum gain reduction from 0 dB to -80 dB. In expander mode, it works as a **RATIO** control setting the expansion ratio. The ratio function determines the input vs. output level ratio, for all signals below the threshold. The setting range is from 1:1 to 1:4.

11 The 8-digit **GAIN REDUCTION** meter informs you about the current amount of gain reduction within a range from 1 to 40 dB.

12 When you press the **COUPLE** switch, this channel is automatically configured as a “slave” channel. Its left neighbor becomes the “master” now controlling both channels in all their parameters.

4.2 The rear panel elements

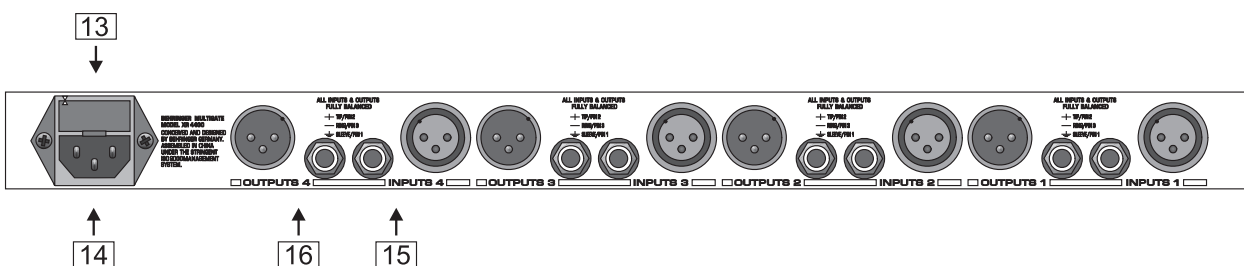

Fig. 4.3: Rear panel elements

13 **FUSE HOLDER / VOLTAGE SELECTOR.** Please make sure that your local voltage matches the voltage indicated on the unit, before you attempt to connect and operate the **MULTIGATE PRO**. Blown fuses may only be replaced by fuses of the same type and rating.

14 **MAINS CONNECTION.** Use the enclosed power cord to connect the unit to the mains. Please also note the instructions given in the “**INSTALLATION**” chapter.

15 **AUDIO IN.** These are the audio inputs of your **MULTIGATE PRO**, available both as balanced 6.3 mm jack and XLR connectors.

- 16 **AUDIO OUT.** These are the audio outputs of your MULTIGATE PRO. Matching phone jack and XLR connectors are wired in parallel.

5. TECHNICAL BACKGROUND

5.1 EXPANDER mode

As already described, a so-called downward expander automatically reduces the overall level of all signals that drop below an adjustable threshold, and thus expands the dynamic range of the program material. In other words, an expander is the opposite of a compressor. Expanders usually work with a relatively flat ratio curve to fade out the signal smoothly.

Noise-gates are a special form of expander using a much steeper ratio curve to abruptly cut the signal when it drops below the threshold. As expanders and gates are quite similar in what they do the following description of expanders and their functionalities also applies to noise-gates.

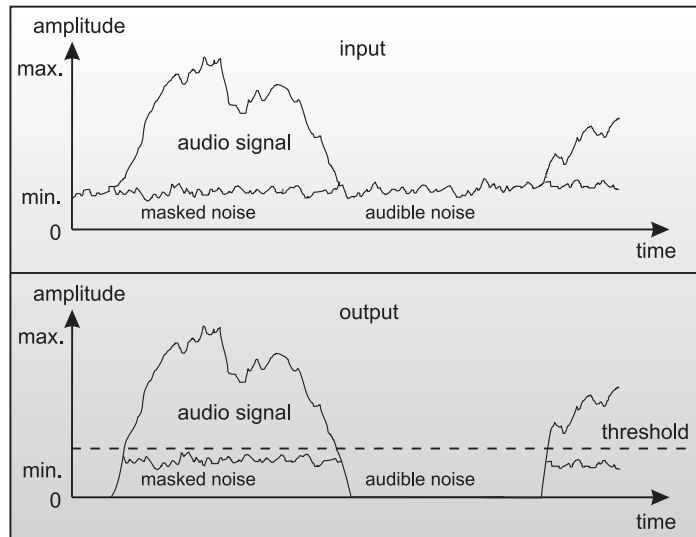

Fig. 6.1: Expander mode

5.2 Interactive control functions

Like the COMPOSER, INTELLIGATE, MULTICOM, and others, the MULTIGATE PRO uses the newly developed INTERACTIVE principle based on a chain of intelligent control functions. For example, the IRC expander (Interactive Ratio Control) does not use a fixed ratio curve but varies this curve depending on the input level and the setting of the THRESHOLD control.

The following chapter describes the interactive control functions in full detail:

5.2.1 THRESHOLD control

The THRESHOLD control determines the threshold point and disables the respective channel. As it covers a very wide setting range it can be easily adapted to any operating level:

Input levels above the adjusted threshold point pass the circuit unprocessed. However, as soon as the input signal drops below the threshold, dynamics processing sets on. Simple noise-gates usually have a control to set the switch-on and switch-off thresholds, but must perform their task without any dedicated control elements that allow for varying the envelopes.

The BEHRINGER MULTIGATE PRO, however, is equipped with all necessary control options. The following section makes clear why it is so important to be able to adjust these parameters.



5.2.2 Attack, release and hold times

The BEHRINGER MULTIGATE PRO is equipped with a MODE switch as well as a HOLD and RELEASE control to adjust the time-domain parameters that determine the so-called envelope:

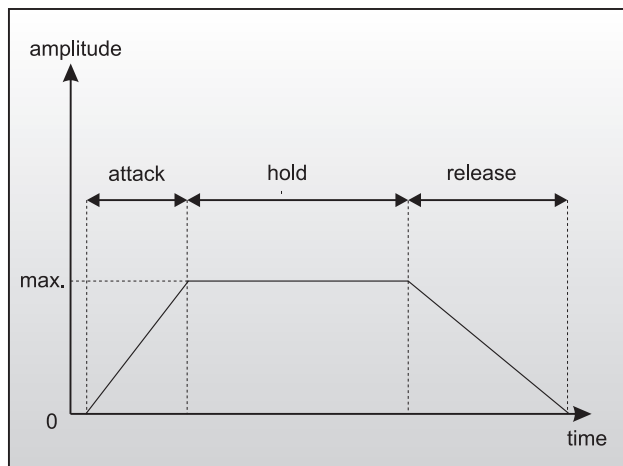

Fig. 6.2: Principle of envelope function

Attack time

The quality of an expander/gate is largely determined by the speed of its attack function (rise time). This parameter defines the time the expander needs after the signal has passed the threshold to recover from the applied gain reduction, i.e. to reverse the control process.

Extremely short transients (level peaks) such as hand claps and percussive instruments, etc. require an extremely short attack time to prevent the expander from cutting the signal flanks and thus deteriorating the sound.

The new BEHRINGER-developed UTR circuit (Ultra Transient Response) in combination with a high-grade VCA allows for an extremely short response time in gate mode, without audible switching noise as it is generated by many conventional designs.

Release time

Another important parameter is the release time, as it determines the time the gate needs to reduce the signal level by a certain amount, after the signal has dropped below the threshold.

Hold time

The hold-time parameter enables you to delay the starting point of the release process. In particular, when processing frequently interrupted signals such as vocals, an additional hold-time parameter is indispensable to prevent the gate from switching off and back on during signal pauses.

5.2.3 IAC circuit (Interactive Attack Control)

The MULTIGATE PRO features an IAC circuit (Interactive Attack Control) which analyzes the program material to calculate the attack time by way of interaction, so that the hold/release process is triggered automatically depending on the program material. This is the reason why the MULTIGATE PRO does not need a dedicated attack control.

5.2.4 RANGE function

On the MULTIGATE PRO the dynamic processing is controlled by a high-grade VCA with a working range of more than 100 dB, i.e. the input signal can be reduced in level by as much as 100 dB.

For most applications, however, it is neither desirable nor necessary to cut the signal completely after it has dropped below the threshold. In particular, when processing signals with lots of background noise, this would result in abrupt and audible control processes that are less likely to enhance the overall sound quality.

For this reason, the MULTIGATE PRO is equipped with a RANGE control that allows you to limit the maximum

gain reduction applied. Thus, you can use smaller amounts of gain reduction making it possible to retain the natural sound of the program material - in particular, with signals that contain plenty of interference noise.

5.2.5 IRC circuit (Interactive Ratio Control)

In conventional expanders the control processes cut the signal abruptly below the threshold, which usually leads to less satisfying results, because the onset of the control function becomes audible. When inaudible expansion is needed, it is therefore better to use a “soft-knee” characteristic around the threshold point that allows for a smoother transition.

The BEHRINGER MULTIGATE PRO uses the newly developed IRC expander (Interactive Ratio Control) whose attack time and ratio characteristics vary automatically depending on the program material.

The IRC expander is switched on with the MODE switch. Low ratios and hence subtle expansion produce a “smooth” transition, while higher ratios and heavy expansion result in a “steeper” transition between the characteristic curves.

This so-called interactive, i.e. nonlinear IRC characteristic is perfectly adapted to human hearing: critical wanted signals around the threshold point are less expanded, while interference signals with lower levels (e.g. background noise) are processed and faded out with a higher expansion ratio.

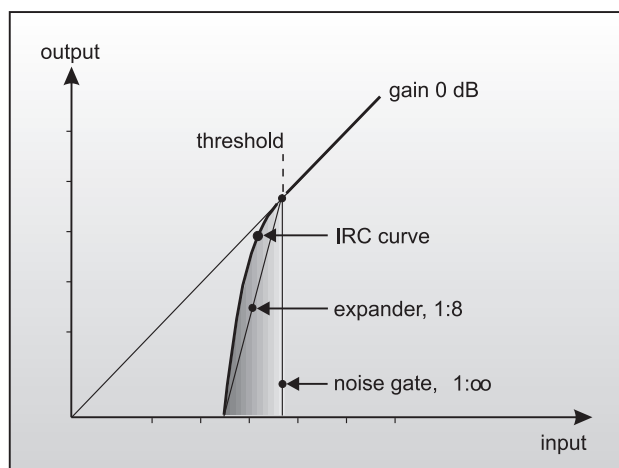

Fig. 6.3: IRC characteristic curve

The result is an expansion process that is less difficult to adjust and more tolerant towards wanted signals whose levels are only slightly above the level of the background noise.

5.2.6 RATIO function

The ratio of the input-level-change vs. output-level-change after the onset of the control process, i.e. after the signal has dropped below the threshold, is called expansion ratio and can be set with the RATIO control. RATIO settings from 1:1.2 through 1:4 give you smooth and exactly dosed downward expansion.

The RATIO scale printed on the front panel indicates the expansion ratio in decibels, i.e. it shows you the decibels by which the output signal is cut for each reduction by one dB of the input signal.

With a 1:1 ratio the output signal level is the same as the input signal level, i.e. there is no signal change. A ratio of 1:2 means that the output signal is reduced by 2 dB when the input signal drops below the threshold by 1 dB. Accordingly, with a ratio of 1:4, the output signal is cut in level by 4 dB when the input signal is 1 dB below the threshold.

5.3 FLEXLINK function

The four channels of the MULTIGATE PRO can be operated both independently of each other and in couple mode. In particular, when you record a choir it will be useful to couple the individual microphone channels. For example, when all microphones are controlled by one singer, all vocals start and stop precisely at the same



point of time. Also when synchronizing several instruments, inaccurate entries of individual musicians can be avoided.

To expand phase-coherent stereo signals (i.e. signals having the same phase), it is imperative that the control processes be triggered simultaneously in both channels. Due to the differences in perceived loudness between the left and right channels, unwanted shifts with reference to the stereo basis would be produced.

The innovative FlexLink function implemented in the MULTIGATE PRO allows for a variety of couple options. For example, when you press the COUPLE switch of channel 3, this channel is automatically configured as a “slave” channel, while its neighbor - channel 2 - becomes the “master” now controlling both channels in all their parameters.

Activating the COUPLE switch automatically disables all controls and switches of channel 3 (except for the MONITOR switch). Now, the controls of channel 2 take over full control of channel 3. Similar to a stereo fader, both channels work in sync. To control channels 2 and 3 from channel 1, simply press the COUPLE switches of channel 2 and 3.

5.4 The SIDE-CHAIN filter

Each channel has a parametric filter whose frequency and quality (bandwidth) can be set precisely. This tunable filter allows you to select and fade out specific frequencies that would otherwise lead to unwanted triggering of the expander circuit.

5.4.1 The MONITOR function

This switch links the side-chain control signal with the audio output, while muting the audio input signal, so that you can pre-monitor the filter output and tune the parametric filter.

 **Please note that the channel’s entire processing functions will be disabled when you press the MONITOR switch.**

6. APPLICATIONS

This chapter describes a few typical applications of the BEHRINGER MULTIGATE PRO. Starting from the basic setting shown below you can find solutions to most dynamics-based problems. Please take your time to study the following application examples thoroughly, so as to be able to fully exploit the variety of features your MULTIGATE PRO offers.

Basically, the BEHRINGER MULTIGATE PRO can be used in three areas of application:

1. Eliminating interference noise and suppressing crosstalk in multi-channel or multi-microphone configurations.
2. Expanding the dynamic range of compressed program material, refreshing sampled sounds and creating special effects and sounds.
3. Using the MULTIGATE PRO as a de-esser and to specifically eliminate interference noise from recordings as well as to reduce the risk of feedback in live situations.

6.1 Basic setting

Understandably, there is no standard setting that suits all kinds of applications. Rather, the controls and switches must be set specifically for the application on hand. However, by studying the following practice-oriented descriptions of typical applications you will soon develop a feel for how the various functions work:

6.1.1 The gate function

“Gating” is a so-called “high ratio” expander function and represents the simplest function of the BEHRINGER MULTIGATE PRO. When the expander is operated with maximum gain reduction (RANGE control fully to the left), it works in “hard gating” mode. The gate function is used to automatically mute single channels in multi-

track mix-downs, stage microphones currently not in use and to suppress background noise and crosstalk in multi-track recordings. In particular, when processing percussive instrument the use of the “hard gating” function is recommended.

A few examples show you how to do it:

Electric signals from percussion instruments have a very short rise time. The time between single hits on the instruments is normally filled up with noise produced by adjacent instruments or room reverb, which makes it difficult or even impossible to separate microphones acoustically. This unwanted crosstalk effect can be accurately eliminated with the MULTIGATE PRO.

Adjust all controls and switches to the following basic settings:

Control elements	Position
MONITOR switch	OUT
SC FILTER switch	OUT
THRESHOLD switch	fully clockwise
HOLD control	center position
RELEASE control	center position
MODE switch	GATE
RANGE/RATIO control	fully counter-clockwise

Tab. 6.1: Initial settings of the MULTIGATE PRO

THRESHOLD control

Now turn the THRESHOLD control counter-clockwise until the lowest signal delivered by the instrument you wish to record triggers the expander and is reproduced without any sound deterioration. The “+” LED lights up as soon as the expander is triggered. When everything’s set up properly, you will hear the instrument clearly “stand out” against the overall sound image.

HOLD control (available in GATE mode only)

The program material (e.g. speech/vocal recordings) often contains many and sometimes very short signal pauses, which could switch the gate off and back on over and again. The hold function prevents this annoying “flutter” effect known from conventional designs, simply by delaying the starting point of the release process. Thus, the gate remains on during short signal pauses. When the adjusted hold time has expired, the gate closes the audio channel depending on how the release function has been set.

 **Please note that this control can be used in gate mode only!**

RELEASE control (available in GATE mode only)

Many percussion instruments have long decay times (e.g. cymbals). As the release time can be adjusted on the MULTIGATE PRO, the device allows you to follow the decay curve of the instrument so that its overall sound character will be retained. In this way, you can avoid that short release times affect the natural decay phase of the instrument or its corresponding reverb ambiance.

Slowly decaying or heavily reverberated signals are best processed with long release times. You will note that with most drum sounds a short release time should be used for the sake of acoustic separation, while longer release times are usually better for cymbals and tom-toms.

Once all control elements have been set properly, your percussion sounds will be “dry”, “powerful” and acoustically well-defined.

 **Please note that this control can be used in gate mode only!**

RANGE control

The RANGE control determines the amount of maximum attenuation of the audio signal. When you process instruments with long decay times, it will be helpful to set the RANGE control to mid-travel position, so that the



signal will not be suppressed completely. Although the MULTIGATE PRO allows for a maximum gain reduction of 80 dB, it is usually not useful to reduce the signal level by this maximum amount. In particular, with highly noise-affected signals we recommend that you use a signal attenuation of not more than 10 to 20 dB, so that the onset of the gate function will not become too obvious.

6.1.2 The expander function

In contrast to the gate function, the expander triggers a continuous attenuation of the signal, as soon as it has dropped below the threshold.

RATIO control

With the MODE switch in, the MULTIGATE PRO works as an interactive expander. The RATIO control determines the expansion curve. For example, when a piece of music was highly compressed during the recording session, the lost dynamics can be restored through complementary expansion. With a bit of feeling you can set the following controls by ear so that the original dynamics (prior to the compression process) will be restored.

We recommend that you set the RATIO control to about 1:1.2 through 1:2 to allow for a “smooth” expansion curve, and that you adjust the THRESHOLD control so that the entire dynamic range of the music piece will be below the threshold point. Now set the THRESHOLD control so that only the loudest passages of the program material surpass the threshold point (“+” LED flashes). In the same way, you can artificially expand the dynamic range of any instrument. In particular, when processing sampled sounds, expansion can produce nice results, because samplers usually have a highly limited dynamic range. When processing percussion sounds (e.g. snare drum) you can use downward expansion to create interesting effects, for example, by setting the threshold to about mid-position, so that only the “lower” part of the dynamics will be processed: the signal decays unchanged until the adjusted threshold is reached, and any subsequent signal portions are faded out with increasing attenuation.

6.2 Proper positioning of microphones

The main task of an expander is to separate unwanted background noise from the actual signal and to eliminate this noise “inaudibly”. Understandably, there must be a minimum difference in the levels of wanted signal and interference signal, so as to be able to define a threshold point for the expander.

However, the optimum operation of an expander depends on the proper choice and positioning of the microphones:

Be extremely careful when instruments with high-frequency portions are played to the sides or back of a microphone with a cardioid polar pattern. Most room microphones suffer from a deterioration of their directivity when picking up high frequencies. For example, with a sensitivity difference of not more than 2-3 dB around 5-10 kHz between the main and lateral axes, cymbals can produce enormous crosstalk in tom-tom microphones, or the hi-hats can mask the sound of the snare drum.

You should make optimum use of the specific directivity of a microphone to acoustically separate other instruments as perfectly as possible. Do as best as you can to separate the sound sources acoustically simply by positioning the microphones correctly.

Yet, in some applications even perfectly positioned microphones might not produce satisfying results. With its side-chain function the BEHRINGER MULTIGATE PRO gives you the option of frequency-selective expansion and thus another aid to ensure perfect acoustic separation of the sound sources.

6.3 Applications

6.3.1 Suppressing crosstalk in multi-track applications

One of the most frequent applications of an expander/gate is the elimination of unwanted crosstalk between single channels during recording or playback. In particular, when recording acoustic drum sounds, this type of application is frequently used, because here several microphones closely positioned next to each other are used.



The high sound pressure levels of the individual instruments lead to crosstalk in adjacent microphones. Frequency cancellations and a non-defined sound (“comb filter” effect) are the result. It has proven wise to use a separate microphone for each drum instrument and to “gate” each microphone channel.

Insert the BEHRINGER MULTIGATE PRO into the recording channel of the snare drum, for example, and adjust the device so that it responds only to hits on the snare drum. Each single microphone should be optimally positioned before, and the threshold of the respective channel should be set so that the drum sound can be separated cleanly, just as if the instrument were played alone.

6.3.2 Reducing crosstalk in stage microphones

The MULTIGATE PRO can be used in a variety of live/stage and multi-microphone applications: a moderately set expander can effectively suppress background noise, or the noise build-up that is typically produced by compressors as well as crosstalk between microphones, etc. without causing other unwanted side effects.

Typically, an expander can be used to process vocal tracks. Particularly when using a compressor, the distance between singer and microphone is of crucial importance: As the distance increases, more and more disturbing background noise is picked up. You should therefore use the expander function to fade out unwanted interference noise “inaudibly” during signal pauses.

In live situations you can eliminate bleeding, for instance, from drum to piano tracks, or clean your recordings from other acoustic “pollution”.

If you do not have enough microphones (or MULTIGATE PRO!) to record each instrument separately, try forming so-called sub-groups: comprise the snare and middle toms, side toms, kick drum and cymbals in one group using the sub-group facilities on your mixing console.

The goal is to position the group’s microphones and to adjust the expander so that with each hit on a specific instrument only one microphone opens, thus transmitting only one specific instrument, while the remaining microphones remain muted.

6.3.3 Reducing feedback in stage microphones

As soon as a singer sings into his/her microphone, background noise is masked and thus not perceived. During signal pauses, however, the microphone picks up the noise from P.A. and monitor speakers, which can lead to torturing feedback.

By inserting the MULTIGATE PRO into the vocal channel and by adjusting it to mute the microphone when it is not in use, you can reduce the risk of feedback in this particular channel.

Basically, this configuration should be used for all stage microphones.

7. SPECIFICATIONS

AUDIO INPUT

Connectors	XLR and 1/4" jack
Type	RF filtered, servo-balanced input
Impedance	50 kOhm balanced, 25 kOhm unbalanced
Max. Input Level	+21 dBu balanced and unbalanced
CMRR	typ. 40 dB, >55 dB @ 1 kHz

AUDIO OUTPUT

Connectors	XLR and 1/4" jack
Type	Electronically servo-balanced output stage
Impedance	60 Ohms balanced, 30 Ohm unbalanced
Max. Output Level	+21 dBu, +20 dBm balanced and unbalanced

SYSTEM SPECIFICATIONS

Frequency Response	18 Hz to 30 kHz, +/- 3 dB
Noise	>95 dBu, unweighted, 22 Hz to 22 kHz
THD	0.008 % typ. @ +4 dBu, 1 kHz, Gain 1
IMD	0.01 % typ. SMPTE
Crosstalk	<-100 dB, 22 Hz to 22 kHz

GATE SECTION

Type	UTR (Ultra Transient Response) gate
Threshold	variable (BYPASS to +10 dBu)
Attack	program dependent
Hold	variable (0 to 4 sec)
Release	variable (50 ms to 4 sec)
Range	variable (0 to -80 dB)

EXPANDER SECTION

Type	IRC (Interactive Ratio Control) expander
Attack	program dependent
Ratio	variable (1:1 to 1:4)

SIDE-CHAIN FILTER

Frequency	variable (100 Hz to 10 kHz)
BW (Bandwidth)	variable (2.3 to 0.7 oct.)

FUNCTION SWITCHES

Monitor	monitors the side-chain key signal
Filter	activates the side-chain filter
Mode	gate/expander switch
Couple	activates the FlexLink function

INDICATORS

"-" indicator	signal is below threshold
"Hold" indicator	signal reaches the threshold
"+" indicator	signal is above threshold
Gain Reduction	8-segment LED display: 1/3/6/10/15/20/30/40 dB

LED indicator for each function switch

POWER SUPPLY

Mains Voltages	USA/Canada	~ 120 V AC, 60 Hz
	U.K./Australia	~ 240 V AC, 50 Hz
	Europe	~ 230 V AC, 50 Hz
	General Export Model	~ 100-120 V AC, ~ 200-240 V AC, 50-60 Hz
Power Consumption	15 Watts	
Fuse	100-120 V AC: 630 mA (slow-blow) 200-240 V AC: 315 mA (slow-blow)	
Mains Connection	Standard IEC receptacle	

PHYSICAL

Dimension	1 3/4" (44.5 mm) * 19" (482.6 mm) * 8 1/2" (217 mm)
Net Weight	approx. 2.5 kg
Shipping Weight	approx. 3.5 kg

BEHRINGER is constantly striving to maintain the highest professional standards. As a result of these efforts, modifications may be made from time to time to existing products without prior notice. Specifications and appearance may differ from those listed or shown.

8. WARRANTY

§ 1 WARRANTY CARD

To be protected by this warranty, the buyer must complete and return the enclosed warranty card (signed/stamped by retail dealer) within 14 days of the date of purchase to BEHRINGER INTERNATIONAL (address see § 3). Failure to return the card in due time (date as per postmark) will void any extended warranty claims.

§ 2 WARRANTY

1. BEHRINGER INTERNATIONAL warrants the mechanical and electronic components of this product to be free of defects in material and workmanship for a period of one (1) year from the original date of purchase, in accordance with the warranty regulations described below. If any defects occur within the specified warranty period that are not caused by normal wear or inappropriate use, BEHRINGER INTERNATIONAL shall, at its sole discretion, either repair or replace the product.

2. If the warranty claim proves to be justified, the product will be returned freight prepaid by BEHRINGER INTERNATIONAL within Germany. Outside of Germany, the product will be returned at the buyer's expense.

3. Warranty claims other than those indicated above are expressly excluded.

§ 3 RETURN AUTHORIZATION NUMBER

1. To obtain warranty service, the buyer must call BEHRINGER INTERNATIONAL during normal business hours BEFORE returning the product (Tel.: +49 (0) 21 54 / 92 06 66). All inquiries must be accompanied by a description of the problem. BEHRINGER INTERNATIONAL will then issue a return authorization number.

2. The product must be returned in its original shipping carton, together with the return authorization number, to the following address:

BEHRINGER INTERNATIONAL GmbH
Service Department
Hanns-Martin-Schleyer-Str. 36-38
D - 47877 Willich-Münchheide

3. Shipments without freight prepaid will not be accepted.

§ 4 WARRANTY REGULATIONS

1. Warranty services will be furnished only if the product is accompanied by an original retail dealer's invoice. Any product deemed eligible for repair or replacement by BEHRINGER INTERNATIONAL under the terms of this warranty will be repaired or replaced within 30 days of receipt of the product at BEHRINGER INTERNATIONAL.

2. If the product needs to be modified or adapted in order to comply with applicable technical or safety standards on a national or local level, in any country which is not the country for which the product was originally developed and manufactured, this modification/adaptation shall not be considered a defect in materials or workman-

ship. The warranty does not cover any such modification/adaptation, irrespective of whether it was carried out properly or not. Under the terms of this warranty, BEHRINGER INTERNATIONAL shall not be held responsible for any cost resulting from such a modification/adaptation.

3. Free inspections, maintenance/repair work and replacement of parts are expressly excluded from this warranty, in particular if caused by inappropriate use. Likewise, the warranty does not cover defects of expendable parts caused by normal wear of the product. Expendable parts are typically faders, potentiometers, switches and similar components.

4. Damages/defects caused by the following conditions are not covered by this warranty:

- ▲ misuse, neglect or failure to operate the unit in compliance with the instructions given in the user or service manuals.
- ▲ connection or operation of the unit in any way that does not comply with the technical or safety regulations applicable in the country where the product is used.
- ▲ damages/defects that are caused by force majeure or by any other condition beyond the control of BEHRINGER INTERNATIONAL.

5. Any repair carried out by unauthorized personnel will void the warranty.

6. Products which do not meet the terms of this warranty will be repaired exclusively at the buyer's expense. BEHRINGER INTERNATIONAL will inform the buyer of any such circumstance. If the buyer fails to submit a written repair order within 4 weeks after notification, BEHRINGER INTERNATIONAL will return the unit C.O.D. with a separate invoice for freight and packing. Such cost will also be invoiced separately when the buyer has sent in a written repair order.

§ 5 WARRANTY TRANSFERABILITY

This warranty is extended exclusively to the original buyer (customer of retail dealer) and is not transferable to anyone who may subsequently purchase this product. No other person (retail dealer, etc.) shall be entitled to give any warranty promise on behalf of BEHRINGER INTERNATIONAL.

§ 6 CLAIM FOR DAMAGES

Failure of BEHRINGER INTERNATIONAL to provide proper warranty service shall not entitle the buyer to claim (consequential) damages. In no event shall the liability of BEHRINGER INTERNATIONAL exceed the invoiced value of the product.

§ 7 OTHER WARRANTY RIGHTS

This warranty does not exclude or limit the buyer's statutory rights provided by national law, in particular, any such rights against the seller that arise from a legally effective purchase contract.

The information contained in this manual is subject to change without notice. No part of this manual may be reproduced or transmitted in any form or by any means, electronic or mechanical, including photocopying and recording of any kind, for any purpose, without the express written permission of BEHRINGER GmbH.

BEHRINGER and MULTIGATE are registered trademarks. ALL RIGHTS RESERVED © 1999 BEHRINGER.
BEHRINGER INTERNATIONAL GmbH, Hanns-Martin-Schleyer-Str. 36-38, D-47877 Willich-Münchheide II
Tel. +49 (0) 21 54 / 92 06-0, Fax +49 (0) 21 54 / 92 06-30

