



SPEAKER SYSTEM

C112V/C115V/C215V

CM10V/CM12V/CM15V

C112VA/C115VA

SUBWOOFER

CW115V/CW118V/CW218V

Owner's Manual

Thank you for choosing the YAMAHA speaker system. In order to take maximum advantage of the speaker's features and ensure maximum performance and longevity, please read this manual carefully before using the speaker system. Keep the manual in a safe place for future reference.

Bedienungsanleitung

Wir beglückwünschen Sie zum Kauf dieses YAMAHA -Lautsprechersystems. Damit Sie die Ausstattungen dieses Lautsprechersystems optimal nutzen können, und um maximale Leistung und Lebensdauer sicherzustellen, lesen Sie bitte vor der Inbetriebnahme diese Anleitung sorgfältig durch. Bitte bewahren Sie diese Bedienungsanleitung gut auf, um bei Bedarf darauf zurückgreifen zu können.

Mode d'emploi

Nous vous remercions d'avoir acheté les enceintes YAMAHA. Pour obtenir les performances optimales de vos enceintes et garantir une longévité maximale, lisez attentivement ce mode d'emploi avant d'utiliser les enceintes. Conservez-le en lieu sûr pour pouvoir vous y référer ultérieurement.

Manual de instrucciones

Gracias por escoger el sistema de altavoces YAMAHA. A fin de aprovechar al máximo las características de los altavoces y obtener un rendimiento y durabilidad óptimos, lea atentamente este manual antes de utilizar el sistema. Guarde este manual en un lugar seguro para futuras consultas.

取扱説明書

このたびは、ヤマハ製品をお買い求めいただきまして、まことにありがとうございます。スピーカーを安全にご使用いただき、優れた性能を十分に生かして末永くご愛用いただくために、この取扱説明書をご使用の前に必ずお読みください。お読みになったあとは保証書とともに保管してください。

PRECAUTIONS

PLEASE READ CAREFULLY BEFORE PROCEEDING

* Please keep this manual in a safe place for future reference.



WARNING

Always follow the basic precautions listed below to avoid the possibility of serious injury or even death from electrical shock, short-circuiting, damages, fire or other hazards. These precautions include, but are not limited to, the following:

Do not open

- Do not open the device or attempt to disassemble the internal parts or modify them in any way. The device contains no user-serviceable parts. If it should appear to be malfunctioning, discontinue use immediately and have it inspected by qualified Yamaha service personnel.

Water warning

- Do not expose the device to rain, use it near water or in damp or wet conditions, or place containers on it containing liquids which might spill into any openings.



CAUTION

Always follow the basic precautions listed below to avoid the possibility of physical injury to you or others, or damage to the device or other property. These precautions include, but are not limited to, the following:

Location

- If you use a stand, check the stand's specifications and make sure that it is sturdy enough to support the weight of the speaker. You may need to limit the number of people around the placed stand, in order to avoid toppling the device or causing damage to the internal components.
- If you use the TS-80 and TS-90 speaker stands manufactured by Ultimate Systems (sold separately) to support the C112V/C115V/CM10V/CM12V/CM15V speaker models, be sure to keep the following cautions.
 - Use the speaker stands with their legs fully opened.
 - Mount only one speaker on each speaker stand.
 - Tighten fastening screws securely.
 - Remove the speakers from the stands before moving the stands or adjusting their height.
 - Add weight such as sand bags around the stand legs to prevent them from falling over.
 - Use the stand at a maximum height of 140cm (55").
- If you use a metal socket of the CW115V/CW118V subwoofer to allow mounting of a satellite speaker, use a pole shorter than 90cm (35.4") with an outer diameter of 35mm (1-3/8").
- When transporting or moving the device, always use two or more people.
- Before moving the device, remove all connected cables.
- Do not use the speaker's handles for suspended installation. Doing so can result in damage or injury.
- Do not expose the device to excessive dust or vibrations, or extreme cold or heat (such as in direct sunlight, near a heater) to prevent the possibility of panel disfiguration or damage to the internal components.
- Do not place the device in an unstable position where it might accidentally fall over.

Connections

- Before connecting the device to other devices, turn off the power for all devices. Before turning the power on or off for all devices, set all volume levels to minimum.
- Use only speaker cables for connecting speakers to the speaker jacks. Use of other types of cables may result in fire.
- Be sure to observe the amplifier's rated load impedance (see page 4), particularly when connecting speakers in parallel. Connecting an impedance load outside the amplifier's rated range can damage the amplifier.

Handling caution

- Always turn AC power to the power amplifier on last in any audio system to avoid speaker damage. When turning power off, the power amplifier should be turned off first for the same reason.
- Do not use the device for a long period of time at a high or uncomfortable volume level, since this can cause permanent hearing loss. If you experience any hearing loss or ringing in the ears, consult a physician.
- Do not operate the device if the sound is distorting. Prolonged use in this condition could cause overheating and result in fire.



This product, when used in combination with amplification and/or additional loudspeakers, may be capable of producing sound levels that could cause permanent hearing loss.

DO NOT operate at high volume levels or at a level that is uncomfortable. If you experience any discomfort or ringing in the ears, or suspect an hearing loss, you should consult an audiologist.

To protect your speakers

When choosing a power amplifier to use with your speakers, make sure that its power output matches the speakers' power capacity (refer to the Specifications on page 7). Even if the amplifier's power output is lower than the speakers' PGM (program) power capacity, the speakers may be damaged when clipping of a high input signal occurs.

The following may cause damage to speakers:

- Feedback caused when using a microphone.
- Continuous high sound pressure level produced by electronic instruments.
- Continuous high-power output distorted signals.
- Popping noises caused by turning on equipment, or by connecting or disconnecting system components while the amplifier is turned on.

Poly Switch

All full-range loudspeakers are fitted with a self-resetting poly switch that protects the high-frequency driver from damage caused by excessive power.

If a loudspeaker cabinet loses high-frequency output, immediately remove power from the unit and wait for two to three minutes. They should allow the poly switch to reset. Re-apply power and check the performance of the high-frequency driver before continuing with the power reduced to a level that does not cause the poly switch to interrupt the signal.

On the CW115V/CW118V/CW218V subwoofer, the Poly Switch protects the woofer and a similar routine should be followed if its output is lost.

- In any system using two or more speakers, be sure to match the connection polarities of all speakers to the amplifier(s) – e.g. always connect “+” to “+” and “-” to “-”. If the polarities are not properly matched the speakers will be driven out of phase and the sound will suffer.
- Use only Neutrik NL4FC plugs for connecting Speakon connectors.

Yamaha cannot be held responsible for damage caused by improper use or modifications to the device.

- * Illustrations in this manual are for explanatory purposes only, and may not match the actual appearance of the product during operation.
- * Company names and product names used in this Owner's Manual are trademarks or registered trademarks of their respective owners.

Connecting the Speakers

■ Phone Plug Wiring

Phone plugs for connection to the phone jack inputs should be wired as shown to the right. Be sure to use proper speaker cable — NOT shielded instrument or line cable — for all speaker connections.

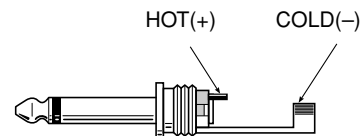

■ Neutrik Speakon NL4FC Plug Wiring

If you will be using the Neutrik connectors for speaker input, wire the plugs as shown to the right. Be sure to use proper speaker cable — NOT shielded instrument or line cable — for all speaker connections.

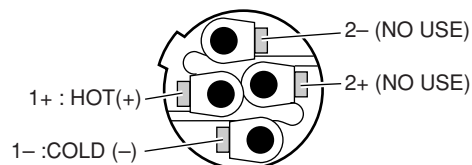

Neutrik NL4FC connector

■ Full-range Connection

Each speaker (except for the C112VA/ C115VA) features four input/parallel connectors—two 1/4" phone jacks and two Neutrik Speakon NL4AMP connectors. Use either a phone jack or a Speakon connector to receive input from your sound system/power amplifier. One of the spare connectors can be used to parallel-connect an additional speaker (keeping in mind the impedance considerations mentioned below).

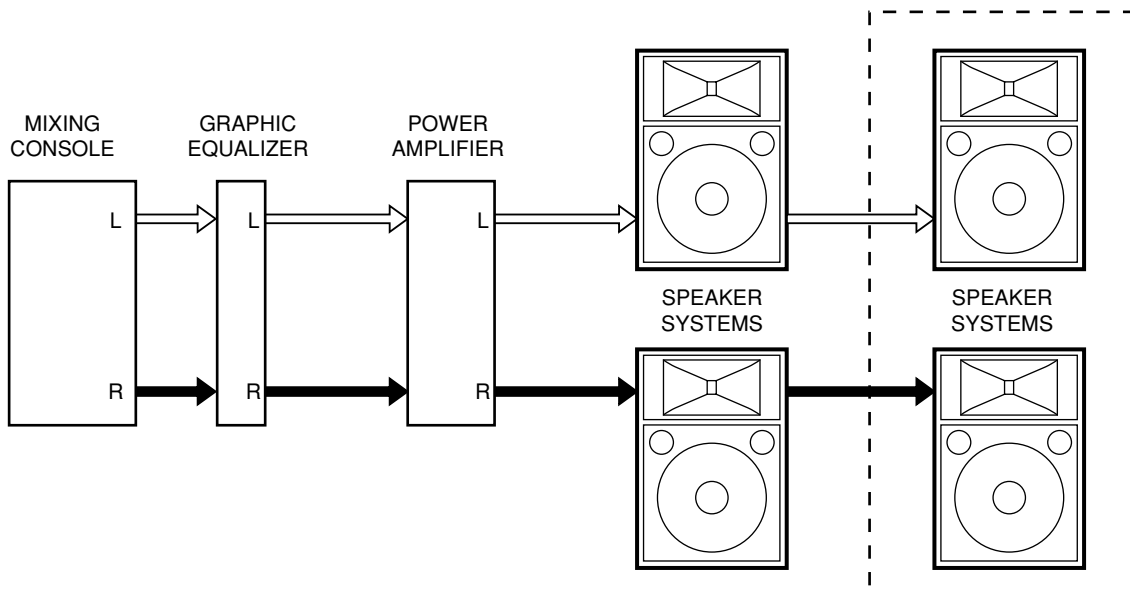

Impedance Considerations

When connecting speakers in parallel be sure to check the rated load impedance of the power amplifier. Most power amplifiers are capable of safely driving speakers with minimum impedance of 8 ohms or 4 ohms. A pair of parallel-connected 8-ohm speakers have a total impedance of 4 ohms. Two 8-ohm speakers can safely be paralleled on one output. 4-ohm speakers, however, should not be parallel-connected with other speakers. These models can be connected in parallel, however, if you are using a power amplifier that can safely drive load impedances of 2 ohms or lower. Check your speaker impedance on page 7.

■ Subwoofers and the PN90 Crossover Network

Adding subwoofers to speaker systems like the one shown in the diagram can provide extended frequency range and superior overall sound quality. After dividing the line-level audio from the preamplifier or mixing console into separate frequency bands via the PN90 crossover network, the separate frequency bands are sent to separate power amplifiers.

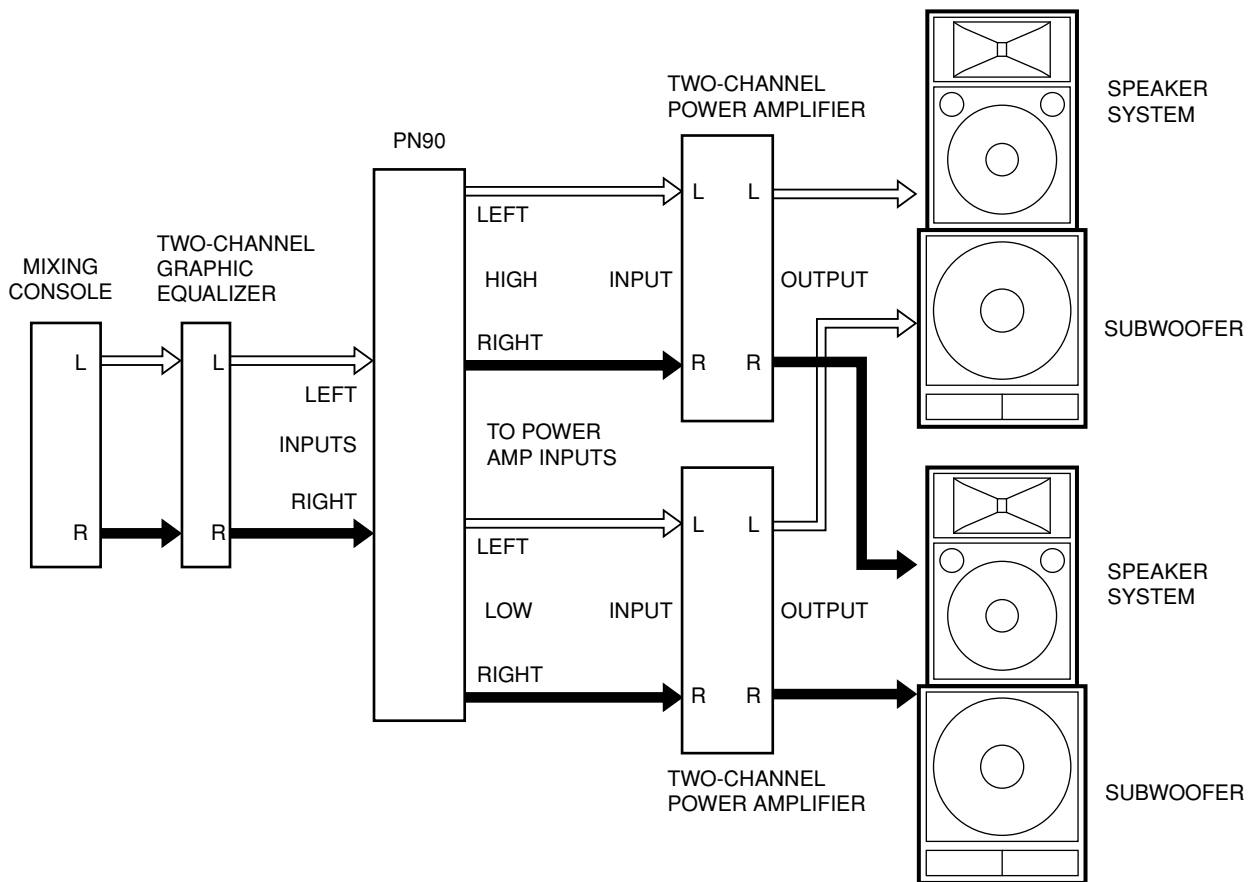

Precautions for operating the PN90

- Do not connect the PN90 between the power amplifier and speakers. The high voltage levels produced can damage the PN90.
- Use the PN90 with a load impedance of between 7.5k Ω and 30k Ω . (Rated load impedance is 15k Ω)
- The polarity of the **LOW** signal is inverted at the crossover point between the **LOW** and **HIGH** signals. Compensate for this by reversing the polarity when connecting the power amplifier output jacks to a subwoofer. Note that you must reverse the polarity between the power amplifier and subwoofers rather than between the PN90 and power amplifier to prevent damage to the connected device.
- The PN90's connectors are unbalanced phone jacks. Use shielded audio cable with phone plugs to connect to the PN90. Do not use speaker cable.
- Adjust the level of the **LOW** and **HIGH** signals using the power amplifier volume controls.

Suspended and Bracket Installation



- Consult an installation expert to arrange for installation or construction work.
- Choose suspension wire, an installation location, and mounting hardware that are strong enough to support the weight of the speaker.
- Some fittings may deteriorate over extended periods of time due to wear or corrosion. For safety the installation should be checked thoroughly at regular intervals.

Yamaha cannot be held responsible for damage or injury caused by insufficient strength of the support structure or improper installation.

■ Suspended Installation

The C112VA and C115VA can be used in suspended “flying” rigs by using an appropriate suspension wire.

1. Replace the bolts with the supplied eyebolts (3/8”) as shown in the diagram, and then suspend the speaker using an appropriate wire.

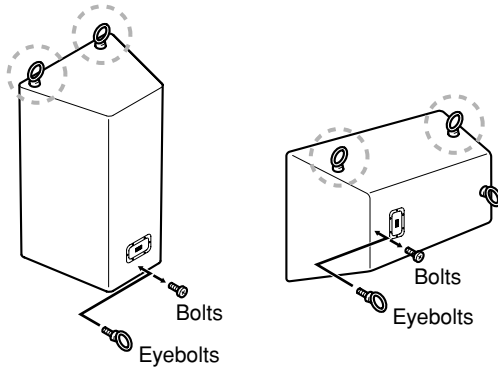

- Use only the supplied eyebolts.
- Use two or more eyebolts for suspended installation. Always use the eyebolts marked .
- Do not suspend a speaker from another suspended speaker.

2. The speaker angle can be adjusted for optimum coverage by adjusting the lengths of the suspension wires, but the downward tilt angle must be less than 45 degrees, as shown in the diagram.

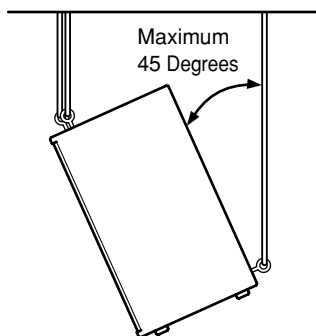

■ Bracket Installation

The C112VA has bracket-mounting screws on the top, bottom, and sides of the speaker enclosure. The C112VA can be mounted on a wall or ceiling using the optional brackets listed below.

Bracket	Model
Wall bracket	BWS251-300, BWS251-400
Ceiling bracket	BCS251
Baton bracket	BBS251

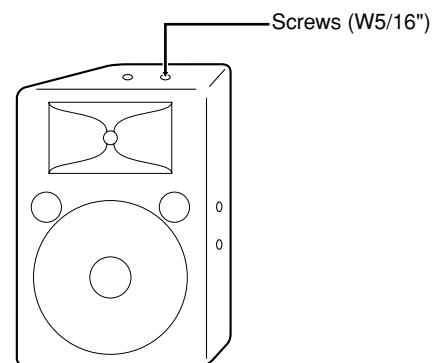

- **Use only the specified screws (W5/16”) to attach the bracket to the speaker.**

The mounting screws are installed on the speaker when it leaves the factory. Refer to the instruction manual supplied with your bracket for installation details.

Specifications

Model		CM10V	C112V	C112VA	CM12V	C115V	C115VA	CM15V	C215V
Enclosure		Bass Reflex Type							
Speaker Unit	LF	10" cone			12" cone		15" cone		15" cone × 2
	HF	1" V.C.driver			2" V.C.driver				
Frequency Response		70Hz-20kHz		60Hz-16kHz			55Hz-16kHz		42Hz-16kHz
Power Capacity	NOISE*	125W		175W			250W		500W
	PGM	250W		350W			500W		1000W
	MAX	500W		700W			1000W		2000W
Nominal Impedance		8Ω							4Ω
Sensitivity		96dB SPL (1W, 1m)		97dB SPL (1W, 1m)			99dB SPL (1W, 1m)		99dB SPL (1W, 1m)
Nominal Dispersion	Horizontal	40°	90°	90°	40°	90°	90°	40°	90°
	Vertical	60°	40°	40°	90°	40°	40°	90°	40°
Crossover Frequency		1.8kHz		2kHz			1.7kHz		1.5kHz
Input Connectors		1/4" Phone Jack × 2, Neutrik Speakon NL4MP × 2		Barrier Strip Terminal	1/4" Phone Jack × 2, Neutrik Speakon NL4MP × 2		Barrier Strip Terminal	1/4" Phone Jack × 2, Neutrik Speakon NL4MP × 2	
Dimensions (W × H × D)		556 × 349 × 273mm	416 × 628 × 329mm	416 × 620 × 329mm	628 × 410 × 339mm	485 × 715 × 373mm	485 × 707 × 373mm	715 × 479 × 339mm	491 × 1163 × 593mm
Weight		13.3Kg	21.3Kg	21.8Kg	21.8Kg	30.3Kg	29.9Kg	28.8Kg	47.5Kg
Included Accessories		—	—	Eyebolt (3/8") × 4	—	—	Eyebolt (3/8") × 4	—	—

C112V/C112VA/C115V/C115VA

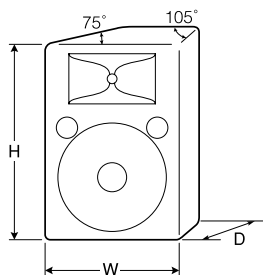

CM10V/CM12V/CM15V

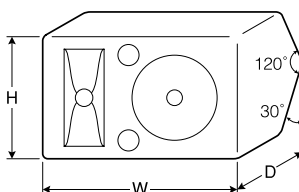

C215V

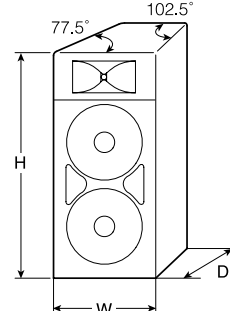

Model		CW115V	CW118V	CW218V
Enclosure		Bass Reflex Type		
Speaker Unit		15" cone	18" cone	18" cone × 2
Frequency Response		35Hz-2kHz		30Hz-2kHz
Power Capacity	NOISE*	250W	300W	600W
	PGM	500W	600W	1200W
	MAX	1000W	1200W	2400W
Nominal Impedance		8Ω		4Ω
Sensitivity		95dB SPL (1W, 1m)	96dB SPL (1W, 1m)	98dB SPL (1W, 1m)
Recommended Crossover Frequency		90Hz, 12dB/oct.		
Input Connectors		1/4" Phone Jack × 2, Neutrik Speakon NL4MP × 2		
Dimensions (W × H × D)		500 × 607 × 528mm	605 × 720 × 637mm	1217 × 574 × 655mm
Weight		28Kg	37.2Kg	64.7Kg

Specifications and descriptions in this owner's manual are for information purposes only. Yamaha Corp. reserves the right to change or modify products or specifications at any time without prior notice. Since specifications, equipment or options may not be the same in every locale, please check with your Yamaha dealer.

*: EIA RS-426

CW115V/CW118V

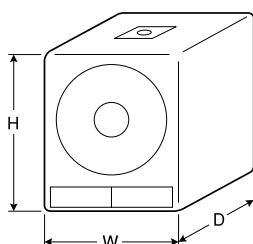

CW218V

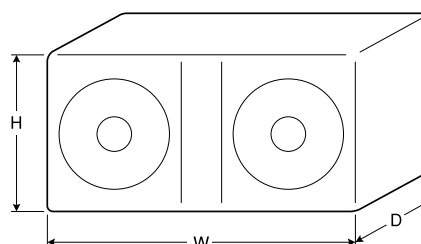

Unit: mm

■ Frequency Response/Impedance

• CM10V

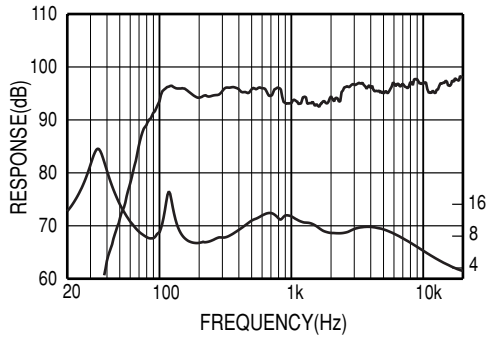

• C115V/CM15V/C115VA

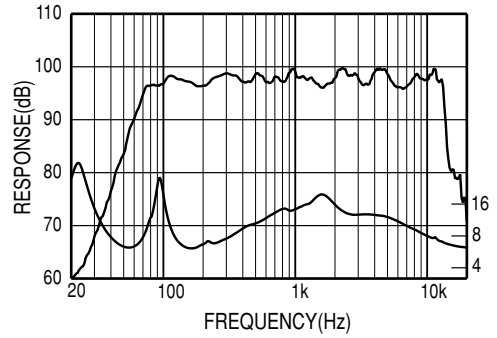

• C112V/CM12V/C112VA

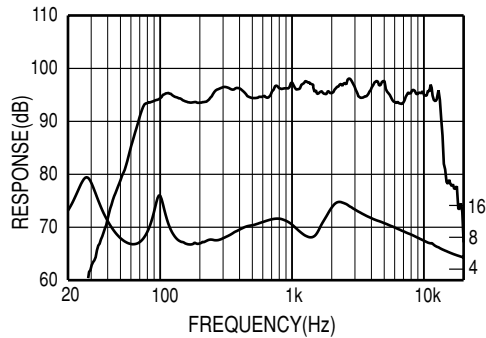

• C215V

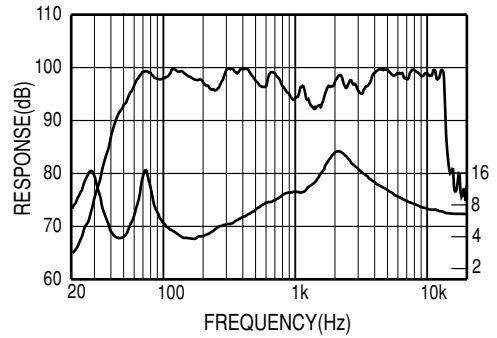

• CW115V

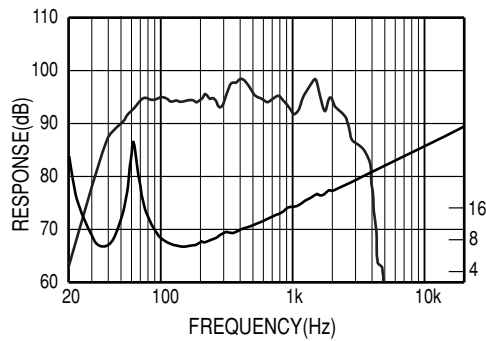

• CW118V

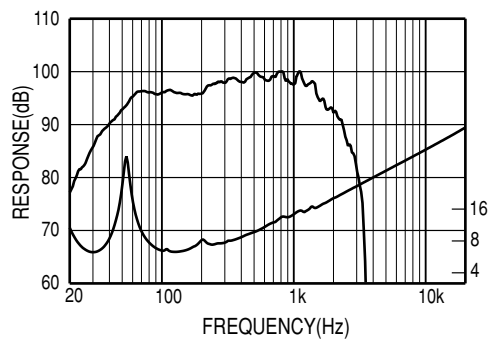

• CW218V

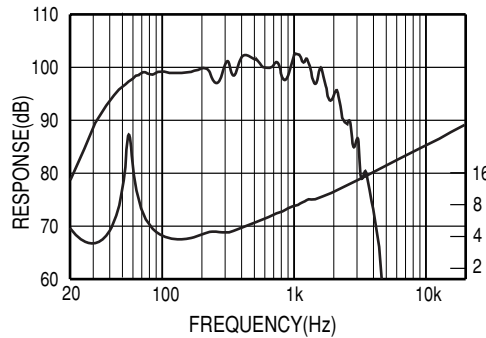

■ Horizontal Directivity

• CM10V

- 500Hz ———
- 1kHz - - - - -
- 2kHz ———

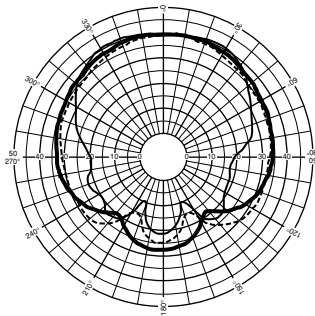

- 4kHz ———
- 8kHz - - - - -
- 16kHz ———

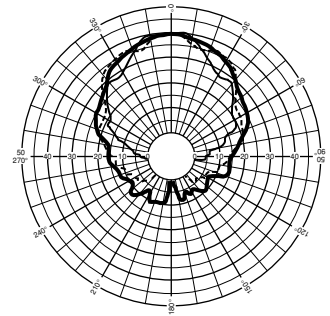

• C112V/CM12V/C112VA

- 500Hz ———
- 1kHz - - - - -
- 2kHz ———

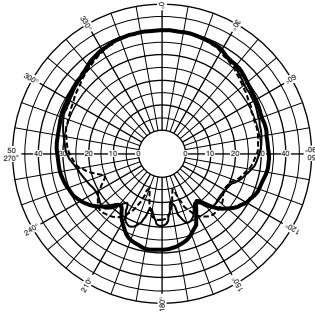

- 4kHz ———
- 8kHz - - - - -
- 16kHz ———

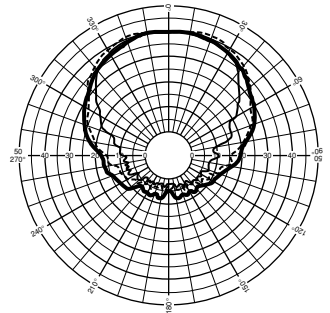

• C115V/CM15V/C115VA

- 500Hz ———
- 1kHz - - - - -
- 2kHz ———

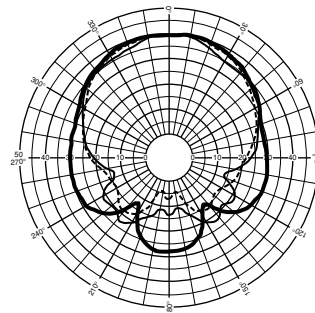

- 4kHz ———
- 8kHz - - - - -
- 16kHz ———

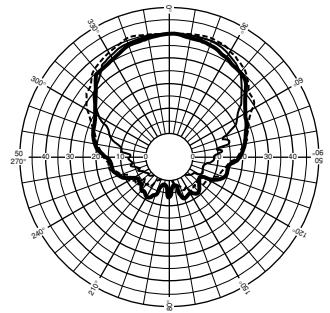

• C215V

- 500Hz ———
- 1kHz - - - - -
- 2kHz ———

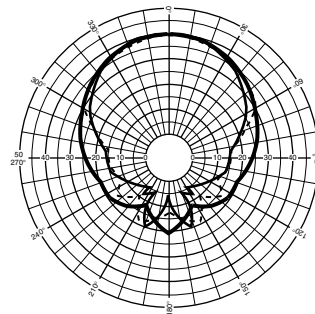

- 4kHz ———
- 8kHz - - - - -
- 16kHz ———

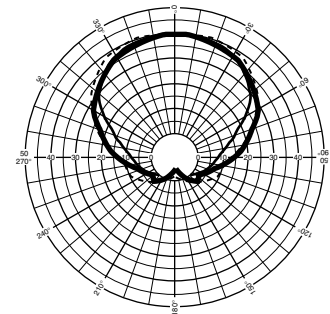

■ Vertical Directivity

• CM10V

- 500Hz ———
- 1kHz - - - - -
- 2kHz ———

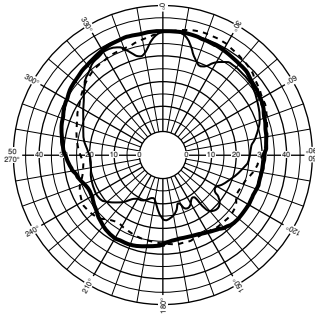

- 4kHz ———
- 8kHz - - - - -
- 16kHz ———

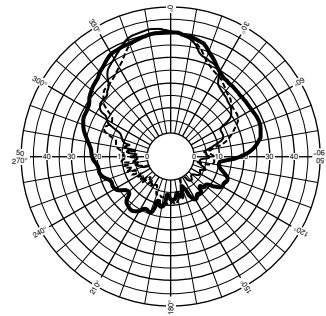

• C112V/CM12V/C112VA

- 500Hz ———
- 1kHz - - - - -
- 2kHz ———

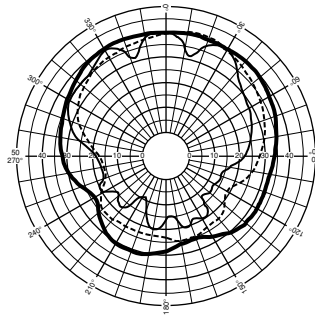

- 4kHz ———
- 8kHz - - - - -
- 16kHz ———

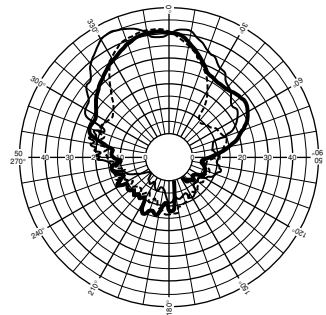

• C115V/CM15V/C115VA

- 500Hz ———
- 1kHz - - - - -
- 2kHz ———

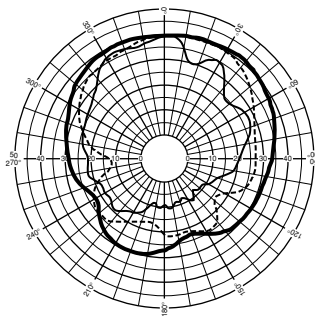

- 4kHz ———
- 8kHz - - - - -
- 16kHz ———

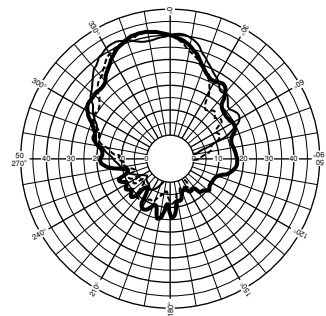

• C215V

- 500Hz ———
- 1kHz - - - - -
- 2kHz ———

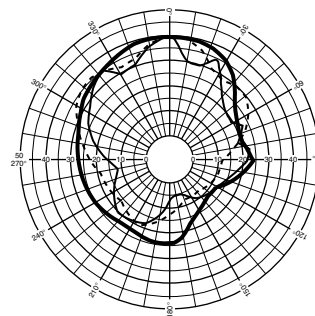

- 4kHz ———
- 8kHz - - - - -
- 16kHz ———

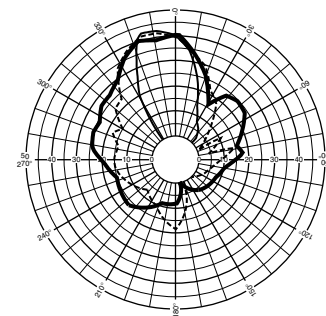

For details of products, please contact your nearest Yamaha representative or the authorized distributor listed below.

Pour plus de détails sur les produits, veuillez-vous adresser à Yamaha ou au distributeur le plus proche de vous figurant dans la liste suivante.

Die Einzelheiten zu Produkten sind bei Ihrer unten aufgeführten Niederlassung und bei Yamaha Vertragshändlern in den jeweiligen Bestimmungsländern erhältlich.

Para detalles sobre productos, contacte su tienda Yamaha más cercana o el distribuidor autorizado que se lista debajo.

NORTH AMERICA

CANADA

Yamaha Canada Music Ltd.
135 Milner Avenue, Scarborough, Ontario,
M1S 3R1, Canada
Tel: 416-298-1311

U.S.A.

Yamaha Corporation of America
6600 Orangethorpe Ave., Buena Park, Calif. 90620,
U.S.A.
Tel: 714-522-9011

CENTRAL & SOUTH AMERICA

MEXICO

Yamaha de México S.A. de C.V.
Calz. Javier Rojo Gómez #1149,
Col. Guadalupe del Moral
C.P. 09300, México, D.F., México
Tel: 55-5804-0600

BRAZIL

Yamaha Musical do Brasil Ltda.
Av. Reboucas 2636-Pinheiros CEP: 05402-400
Sao Paulo-SP. Brasil
Tel: 011-3085-1377

ARGENTINA

**Yamaha Music Latin America, S.A.
Sucursal de Argentina**
Viamonte 1145 Piso2-B 1053,
Buenos Aires, Argentina
Tel: 1-4371-7021

PANAMA AND OTHER LATIN AMERICAN COUNTRIES/ CARIBBEAN COUNTRIES

Yamaha Music Latin America, S.A.
Torre Banco General, Piso 7, Urbanización Marbella,
Calle 47 y Aquilino de la Guardia,
Ciudad de Panamá, Panamá
Tel: +507-269-5311

EUROPE

THE UNITED KINGDOM

Yamaha-Kemble Music (U.K.) Ltd.
Sherbourne Drive, Tilbrook, Milton Keynes,
MK7 8BL, England
Tel: 01908-366700

GERMANY

Yamaha Music Central Europe GmbH
Siemensstraße 22-34, 25462 Rellingen, Germany
Tel: 04101-3030

SWITZERLAND/LIECHTENSTEIN

**Yamaha Music Central Europe GmbH,
Branch Switzerland**
Seefeldstrasse 94, 8008 Zürich, Switzerland
Tel: 01-383 3990

AUSTRIA

**Yamaha Music Central Europe GmbH,
Branch Austria**
Schleiergasse 20, A-1100 Wien, Austria
Tel: 01-60203900

CZECH REPUBLIC/SLOVAKIA/ HUNGARY/SLOVENIA

**Yamaha Music Central Europe GmbH,
Branch Austria, CEE Department**
Schleiergasse 20, A-1100 Wien, Austria
Tel: 01-602039025

POLAND

**Yamaha Music Central Europe GmbH
Sp.z. o.o. Oddzial w Polsce**
ul. 17 Stycznia 56, PL-02-146 Warszawa, Poland
Tel: 022-868-07-57

THE NETHERLANDS/ BELGIUM/LUXEMBOURG

**Yamaha Music Central Europe GmbH,
Branch Benelux**
Clarissenhof 5-b, 4133 AB Vianen, The Netherlands
Tel: 0347-358 040

FRANCE

Yamaha Musique France
BP 70-77312 Marne-la-Vallée Cedex 2, France
Tel: 01-64-61-4000

ITALY

**Yamaha Musica Italia S.P.A.
Combo Division**
Viale Italia 88, 20020 Lainate (Milano), Italy
Tel: 02-935-771

SPAIN/PORTUGAL

Yamaha-Hazen Música, S.A.
Ctra. de la Corona km. 17, 200, 28230
Las Rozas (Madrid), Spain
Tel: 91-639-8888

SWEDEN

Yamaha Scandinavia AB
J. A. Wettergrens Gata 1
Box 30053
S-400 43 Göteborg, Sweden
Tel: 031 89 34 00

DENMARK

YS Copenhagen Liaison Office
Generatorvej 6A
DK-2730 Herlev, Denmark
Tel: 44 92 49 00

NORWAY

Norsk filial av Yamaha Scandinavia AB
Grini Næringspark 1
N-1345 Østerås, Norway
Tel: 67 16 77 70

OTHER EUROPEAN COUNTRIES

Yamaha Music Central Europe GmbH
Siemensstraße 22-34, 25462 Rellingen, Germany
Tel: +49-4101-3030

AFRICA

**Yamaha Corporation,
Asia-Pacific Music Marketing Group**
Nakazawa-cho 10-1, Hamamatsu, Japan 430-8650
Tel: +81-53-460-2313

MIDDLE EAST

TURKEY/CYPRUS

Yamaha Music Central Europe GmbH
Siemensstraße 22-34, 25462 Rellingen, Germany
Tel: 04101-3030

OTHER COUNTRIES

Yamaha Music Gulf FZE
LB21-128 Jebel Ali Freezone
P.O.Box 17328, Dubai, U.A.E.
Tel: +971-4-881-5868

ASIA

THE PEOPLE'S REPUBLIC OF CHINA

Yamaha Music & Electronics (China) Co.,Ltd.
25/F., United Plaza, 1468 Nanjing Road (West),
Jingan, Shanghai, China
Tel: 021-6247-2211

INDONESIA

**PT. Yamaha Music Indonesia (Distributor)
PT. Nusantik**
Gedung Yamaha Music Center, Jalan Jend. Gatot
Subroto Kav. 4, Jakarta 12930, Indonesia
Tel: 21-520-2577

KOREA

Yamaha Music Korea Ltd.
Tong-Yang Securities Bldg. 16F 23-8 Yoido-dong,
Youngdungpo-ku, Seoul, Korea
Tel: 02-3770-0660

MALAYSIA

Yamaha Music Malaysia, Sdn., Bhd.
Lot 8, Jalan Perbandaran, 47301 Kelana Jaya,
Petaling Jaya, Selangor, Malaysia
Tel: 3-78030900

SINGAPORE

Yamaha Music Asia Pte., Ltd.
#03-11 A-Z Building
140 Paya Lebar Road, Singapore 409015
Tel: 747-4374

TAIWAN

Yamaha KHS Music Co., Ltd.
3F, #6, Sec.2, Nan Jing E. Rd. Taipei.
Taiwan 104, R.O.C.
Tel: 02-2511-8688

THAILAND

Siam Music Yamaha Co., Ltd.
891/1 Siam Motors Building, 15-16 floor
Rama 1 road, Wangmai, Pathumwan
Bangkok 10330, Thailand
Tel: 02-215-2626

OTHER ASIAN COUNTRIES

**Yamaha Corporation,
Asia-Pacific Music Marketing Group**
Nakazawa-cho 10-1, Hamamatsu, Japan 430-8650
Tel: +81-53-460-2317

OCEANIA

AUSTRALIA

Yamaha Music Australia Pty. Ltd.
Level 1, 99 Queensbridge Street, Southbank,
Victoria 3006, Australia
Tel: 3-9693-5111

COUNTRIES AND TRUST

TERRITORIES IN PACIFIC OCEAN

**Yamaha Corporation,
Asia-Pacific Music Marketing Group**
Nakazawa-cho 10-1, Hamamatsu, Japan 430-8650
Tel: +81-53-460-2313

HEAD OFFICE Yamaha Corporation, Pro Audio & Digital Musical Instrument Division
Nakazawa-cho 10-1, Hamamatsu, Japan 430-8650
Tel: +81-53-460-2441