

LIVE SOUND SOLUTIONS

Studiomaster



Studiomaster

UNIT 11,
TORC MK
CHIPPENHAM DRIVE
KINGSTON
MILTON KEYNES
MK10 0BZ
UNITED KINGDOM.

TEL: +44(0)1908 281072 EMAIL ENQUIRIES@STUDIOMASTER.COM

www.studiomaster.com

CLUBXS USER GUIDE

CLUBXS06/08/10/12/16+
PROFESSIONAL MIXER

CONTENTS:

INTRODUCTION	1
APPLICATION	1
FUNCTION	1-7
INSTALLATION	8-9
GLOSSARY OF TECHNICAL TERMS	10-11
BLOCK DIAGRAM	12
TECHNICAL SPECIFICATION	13

INTRODUCTION

Thank you for purchasing Studiomaster CLUBXS series compact mixer which features universal voltage 100-240V, compression function of each mic channel to keep crystal clear sound during Performance. The mixer can play the music via SD card/USB/bluetooth. The mic sound or music of line in can be recorded to SD card/USB to suit for the requirement of solo or band Performance or conference recording. CLUBXS series can also be connected with PC for playback and recording.

APPLICATION

Suitable for the applications in PA system or indoor recording, e.g. Movie/TV/music Recording in theatre/dancing hall/bar/conference hall, etc;

FUNCTION

- 1) 2-12 CH MIC/line and 2CH stereo inputs;
- 2) Compression function of mic channels (0-9dB);
- 3) Built-in USB/SD card/bluetooth playing/recording function;
- 4) 48V phantom power for condenser mic;
- 5) Built-in 16 program DSP with adjustable delay for wonderful effect;
- 6) Main outputs with 2X8 accurate meter to monitor output level;
- 7) Universal voltage 100V-240V;

CHANNEL

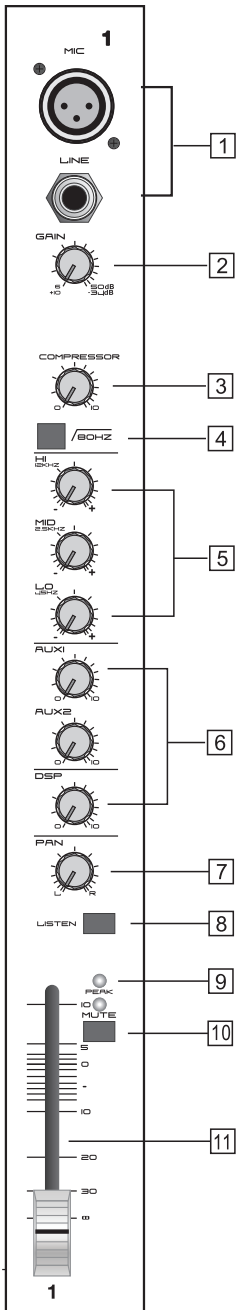

1. MIC/LINE CHANNEL (CH1-6)

Balanced XLR input connector (1: ground; 2: hot; 3: cold). CLUBXS8 is designed with 4 low noise mic pre-amp (CLUBXS6 has 2, CLUBXS8 has 4, CLUBXS10 has 6, CLUBXS12 has 8, CLUBXS16+ has 12) and phantom power, 45dB gain and >100 dB S/N ratio. The phantom power is used for condenser mic. If you use dynamic mic, please turn off phantom power first. These channels are designed with 1/4 inch TRS bal/unbal line in connectors to connect with keyboard, electric drum, DSP, etc.

2. Gain control

It adjusts input signal level to balance the S/N ratio and dynamic range. To get best effect, adjust this knob: make PEAK LED flashes sometimes to avoid channel distortion.

Mic input gain range: 6~50dB, line in gainrange: +10~ -34.

3. COMP:

It adjusts channel compression. Turn clockwise to increase compression ratio and gain will adjust automatically.

4. HPF

It turns on/off the HPF with 18 dB octave to activate 80 Hz LF filter. You can also use it to reduce mains hum noise or stage mic noise.

5. EQ control

Hi: when you set it to max, 12KHz frequency level boosts +15dB. To min, and the 12KHz frequency level cuts -15dB.

MID: when you set it to max, 2.5KHz frequency level boosts +15dB. To min, and the 2.5KHz frequency level cuts -15dB.

LOW: when you set it to max, 45Hz frequency level boosts +15dB. To min, and the 45Hz frequency level cuts -15dB

6. AUX-DSP

These knobs are used to the level of signal sent to AUX-DSP BUS, BUS, and then to external DSP, or to built-in DSP module. DSP knob can also adjust channel level.

7. PAN

Set it to middle position, then sound image will be in the middle of the stage. It can also adjust the left/right output signal.

8. LISTEN (CLUBXS16+ ONLY)

LISTEN: Press this button to send signal to PHONES and CONTROL ROOM for output, the light of "LISTEN" goes on at master control section, output signal is only controlled by PHONES volume.

9. PEAK LED

When signal reaches the level of clipping level deducted 3dB, PEAK LED lights up red.

10. MUTE & LED

Each channel is designed with MUTE button. Press it to mute the channel. The mute LED lights up.

11. FADER

It adjusts the level of channel signal which is sent to main mix out. Note: set the unused faders to minimum position.

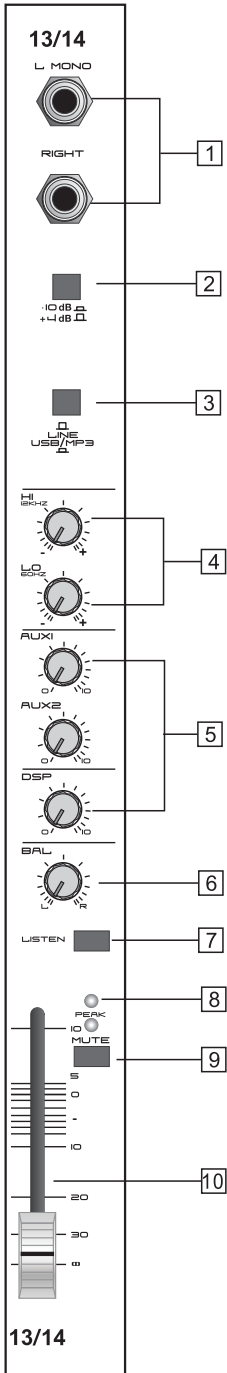

STEREO CHANNEL

1. Stereo channel input

Unbalanced connectors. If signal input from LEFT/MONO, the signal outputs from L/R main mix outputs. If signal inputs from RIGHT connector, signal outputs from R main mix output. This connector can be connected with keyboard, electric drum, DSP, etc.

2. -10/+4 sensitivity switch

Press this switch, this sensitivity will be 10dB higher.

3. LINE/USB/MP3 selection switch

Release for stereo line input. Press for USB/MP3/bluetooth input.

4. EQ control

Hi: set to maximum position, and 12KHz frequency level boosts +15dB. Set to minimum position, and 12KHz frequency level cuts -15dB.

Low: set to maximum position, and 60Hz frequency level boosts +15dB. Set to minimum position, and 60Hz frequency level cuts -15dB.

5. AUX-DSP

These knobs are used to the level of signal sent to AUX-DSP BUS, and then to external DSP, or to built-in DSP module. DSP knob can also adjust channel level.

6. PAN

Set it to middle position, then sound image will be in the middle of the stage. It can also adjust the left/right output signal.

7. LISTEN (CLUBXS16+ ONLY)

LISTEN: Press this button to send signal to PHONES and CONTROL ROOM for output, the light of "LISTEN" goes on at master control section, output signal is only controlled by PHONES volume.

8. PEAK LED

When signal reaches the level of clipping level deducted 3dB, PEAK LED lights up red.

9. MUTE BUTTON & MUTE LED

Each channel is designed with MUTE button. Press it to mute the channel. The mute LED lights up.

10. FADER

It adjusts the channel level.

Note: set the faders of unused channels to minimum position to reduce noise.

OUTPUT AND REAR PANEL

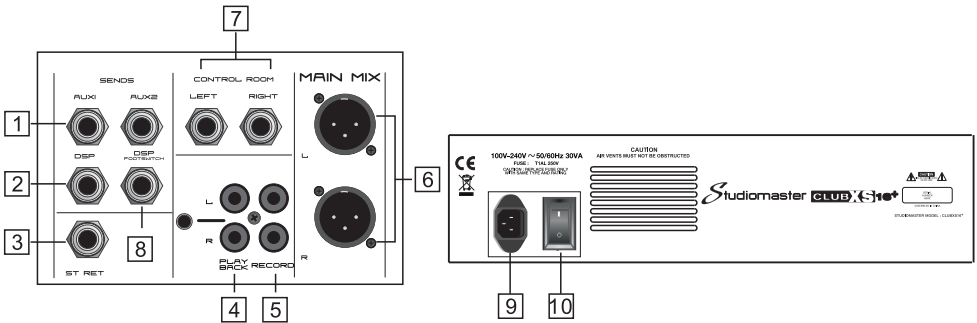

1. AUX SENDS

1/4" phone jacks to send signal from AUX BUS to external equipments, e.g. Effect equipment or stage monitor, etc;

2. DSP output

1/4" phone jack to output DSP signal and the level is controlled by channel DSP.

3. AUX RETURNS input

Stereo 1/4" phone jacks to return effect equipment stereo signal to Main Mix. Or you can Use AUX RETURN knob to adjust volume. The input AUX signal will be sent to MAIN MIX.

4. PLAYBACK

Unbal RCA and 3.5 connectors to input signal from CD player/computer, etc;

5. RECORD

Unbal RCA connector to output signal to recording equipment.

6. MAIN MIX output

Bal XLR connector. The level is adjusted by Main Mix fader.

7. CTRL ROOM output

1/4" phone jacks send Control Room signal to monitor speaker cabinet.

8. DSP FOOTSWITCH(CLUBXS16+ONLY)

Connect a standard latching footswitch with a TRS 1/4" (6.3mm) jack lead to turn on or off the built-in DSP effects.

9. POWER socket

It is designed with fuse to connect with mains. Please replace the fuse with the same type and rating.

10. POWER switch

It turns on/off the mixer.

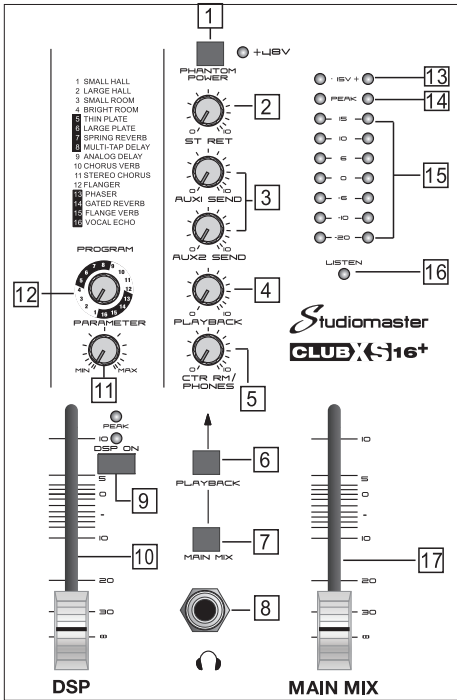

- 1. +48V phantom power switch/red when on**
It is used for condenser mic operation. Please set all faders to minimum before turning on the switch to protect speaker cabinets.
- 2. Stereo return**
It adjusts stereo return signal level.
- 3. AUX1-AUX2 send**
It adjusts aux send level.
- 4. PLAYBACK**
It adjusts the playback signal level.
- 5. CTRL RM/PHONES**
It adjusts the phone signal level.
- 6. PLAYBACK switch**
Press the switch to send signal to monitor and phones.
- 7. MAIN MIX switch**
Press the switch to send MAIN signal to monitor and phones.
- 8. Phone output**
This connector send signal to phones.
- 9. DSP ON switch**
Press this switch to start DSP operation and LED lights up green.
- 10. DSP fader**
It adjusts the DSP signal level.
- 11. PARAMETER**
It adjusts the delay time.

12. PROGRAM

Prg#	Description	Parameter 1
1	Small Hall	Rev Time 0.9sec~3.5sec
2	Large Hall	Rev Time 1.5sec~8.6sec
3	Small Room	Rev Time 0.28sec~0.82sec
4	Bright Room	Rev Time 0.36sec~1.38sec
5	Thin Plate	Rev Time 0.44sec~1.54sec
6	Large Plate	Rev Time 0.72sec~10sec
7	Spring Reverb	Rev Time 0.4sec~2.3sec
8	Multi-tap Delay	Delay Time 0~680ms
9	Analog Delay	Delay Time 0~680ms
10	Chorus Verb	Rev Time 0.56sec~3.5sec
11	STEREO CHORUS	Rate 0.58Hz~6Hz
12	Flanger	Rate 0.58Hz~4.35Hz
13	Phaser	Rate 0.58Hz~11Hz
14	Gated Reverb	Gate Time 0.25sec~0.78sec
15	Flange Verb	Rev Time 0.34sec~2sec
16	Vocal Echo	Delay Time 0~400ms

13. POWER LED

14. PEAK LED

15. MAIN OUTPUT LEVEL LED

16. LISTEN (CLUBXS16+ ONLY)

Check the light of "LISTEN ON" and "OFF" on each channel.

17. MAIN MIX fader

It adjusts the MAIN MIX output level.

SD/USB/BLUETOOTH

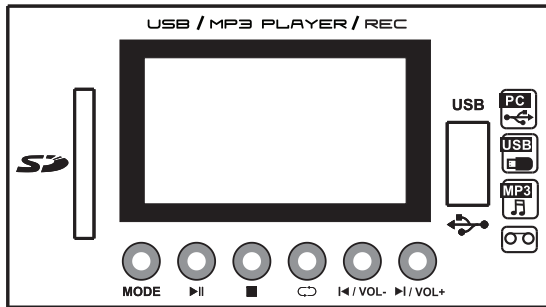

When CLUB XS is turned on the home screen is displayed on the media station. There are a total of 5 functions identified by icons at the top of the screen. Select the required function using the VOL- and VOL+ buttons.

Musical Note symbol: USB/SD card playback

Microphone symbol: USB/SD Record function

Voice: N/A

Bluetooth symbol: Bluetooth playback.

USB symbol: USB playback from PC/Laptop

BLUETOOTH:

Select Bluetooth mode using the VOL- and VOL+ buttons to scroll to the Bluetooth symbol.

To connect, switch on Bluetooth on your device (phone, tablet etc) and position it close to the CLUB XS media station.

Press the PLAY/PAUSE button on your CLUB XS to enter pairing mode.

Select refresh or search on your device so that it can identify CLUB XS as a contact.

Your device will show the CLUB XS under the device name 'Bluetooth'.

Select the device 'Bluetooth' to begin pairing.

Pairing is complete when confirmed by your device and also a scrolling message on the CLUB XS screen which will display your device's name.

Tip: If pairing was unsuccessful or ether device displays an error message, repeat the pairing instructions above. Occasionally it may be necessary to forget 'Bluetooth' on your device and repeat the procedure from the beginning.

Normally once a device is paired with the CLUB XS it will automatically reconnect next time it is switched on and Bluetooth mode is selected. However, not all devices will offer this function, in which case the pairing process will need repeating.

SD card/USB playback:

WMA, WAV and mp3 files are all supported for playback.

When a memory card is plugged-in the CLUB XS will automatically enter the playback mode and play the first file.

Alternatively, press the MODE button to return to the home screen, use VOL- and VOL+ buttons to scroll to USB/SD card playback. Press PLAY/PAUSE button to enter the player.

The file name will scroll across the screen.

The screen displays the selected file number and the total number of files on the memory card.

Use the VOL- and VOL+ buttons to find and select your required file.

Use the PLAY/PAUSE and STOP buttons to control the player.

Loop Functions:

F = play all tracks within same folder in sequence on loop (repeat) USB & SD two devices.

R = shuffle plays all tracks randomly no loop (no repeat)

A = plays all tracks in sequence on loop (repeat)

1 = play one chosen track on loop (repeat) Note in this mode individual tracks cannot be selected.

Selecting and playing individual tracks from a USB or SD card for live performance backing track applications.

Select F in the Loop Function list.

Press twice and hold the PLAY/PAUSE button. Note the pause symbol on the screen.

Use the VOL+ button to select the file.

Release PLAY/PAUSE button.

The file will now remain in pause until the PLAY/PAUSE button is pressed again to start your file.

At the end of the track press STOP.

To select the next file press twice and hold the PLAY/PAUSE button. You will notice that the player has returned to the first file so again use the VOL+ button to search through all files.

Tips for preparing your music files:

Record a track with no sound on it, say 30 seconds long. Call this track '001 Silence' and make sure it's always the first track in your files.

The reason to do this is when inserting the memory card the player will automatically play the first track.

Also when pressing the PLAY/PAUSE button the player may briefly play a section of the first file.

Add about 30 seconds without sound to the end of each song. The player will always automatically play the next track once the previous has finished. Adding a quiet section to the end of the track will give the performer time to stop the player avoiding the next song being played at an unwanted time.

Record function

This function will record the stereo main mix on your CLUB XS to mp3 format at 128kbps mono to a memory card.

An empty memory card is used for this example. Using the VOL- and VOL+ buttons select the record function and enter using the PLAY/PAUSE button.

Any signal routed to the main mix output can now be recorded simply by pressing the PLAY/PAUSE button.

Note that the main mix fader will not change the signal level to the recorder. This is so that during a live recording, the main mix faders are used to control the PA system and any adjustments will not change the recording level.

A folder is automatically placed on the memory card (named RECORD) and all recordings will be stored there. If additional files are added to the same memory card the MODE button is used to switch from the RECORD folder to the additions files.

We should also update the image to reflect what the new designs look like

INSTALLATION

1. There should be no obstacles before the speaker cabinet. You had better put the speaker cabinet on a speaker stand.
2. Use professional devices to suspend or install the speaker cabinets to avoid hurt.
3. Use high quality cable to ensure the best tone.
4. Please match the right power and impedance of power amplifier and speaker cabinet.
5. Do not point the microphone to the speaker cabinet to avoid feedback.

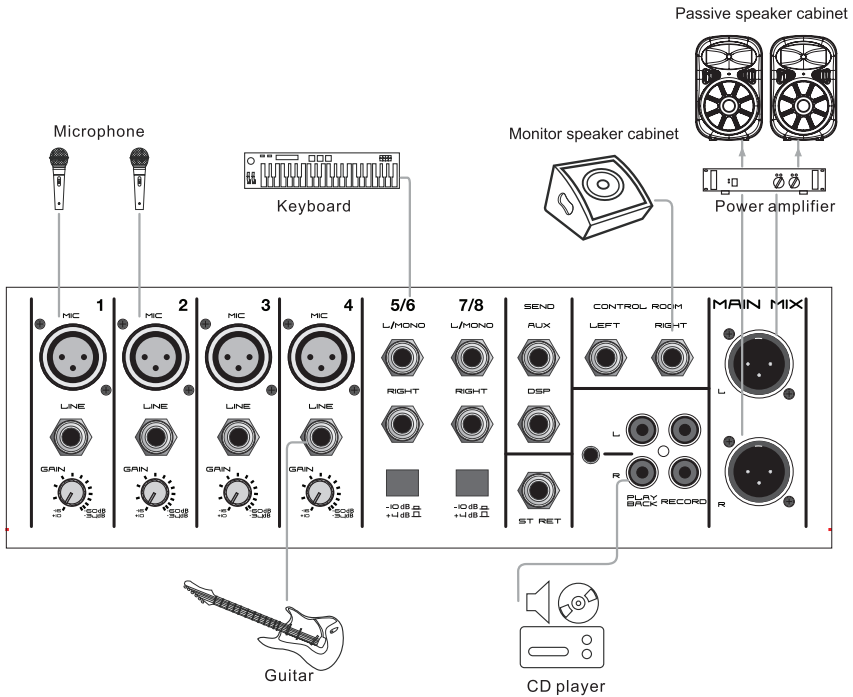

BAL/UNBAL MODE OF TRS/XLR CONNECTORS

1/4 "TRS or XLR connector bal/unbal modes; please refer to below:

1/4 " connector

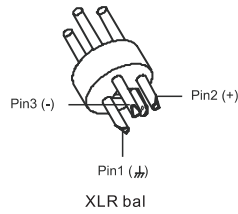
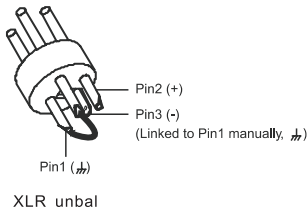
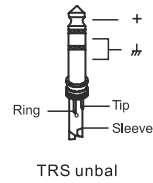
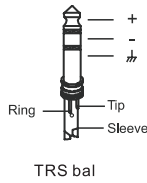
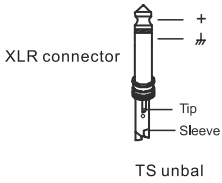

CONNECTION

The supplied 1/4 "TRS and XLR connector to connect with pro audio equipments; please refer to below:

Balanced



Unbalanced



GLOSSARY OF TECHNICAL TERMS

AC or a.c. Alternating current.

AC POWER SUPPLY Local electrical supply

ASSIGN To switch or route a signal to a specific signal path.

ATTENUATE To reduce or make quieter.

BALANCED Balanced 3 connection circuitry is widely used in audio equipment from dynamic microphones to top quality studio devices. The balanced system is used as it cancels outside interference in the connecting cables resulting in a cleaner signal.

BANDWIDTH The bandwidth is the range of frequencies that will pass through a piece of equipment.

BUS A common conductor that carries a signal, or number of signals, through a mixing console.

CLIPPING Distortion caused by a signal exceeding the maximum level that an input can accommodate.

COLD The negative phase of a signal. Usually the black wire in a balanced cable. For an unbalanced signal the SCREEN is used for the COLD connection.

COMPRESSOR An electronic device used to reduce the level of a sound increasing above a set threshold point. Often used on vocals to achieve a more consistent volume level. A compressor can also be used to keep signal levels from overloading the input of a piece of equipment.

CUEING Another word for monitoring, usually when a signal source is prepared to be played at a specific time during a performance. It may be a sound effect for a stage production or an MP3, CD or MD track being available to play so that the music is ready to start immediately.

dBA The most commonly used unit for measuring sound pressure levels. The 'A weighting' takes account of the ear's varying sensitivity to different frequencies, which is most pronounced at low volumes.

dBu A standard reference voltage = 0.775V rms. Derived from the earlier dBm which was used a power ratio in 600ohm circuits.

dBV A standard reference voltage = 1V rms.

DECIBEL (dB) A logarithmic method of measurement for acoustics and electronics. One decibel (1/10th of a Bell) is the smallest change in loudness perceptible by the human ear, although 'trained ears' can detect smaller changes. 0dB (acoustic) is the threshold of human hearing at mid range frequencies.

DELAY A delay is an electronic effects processor which samples a short sound and replays it back a short time later to give an echo effect. Delays are also used in live sound to ensure that the sound from speakers spaced apart from each other arrive at the listeners ears at the same time.

D.I. Direct Injection. Often a small 'D.I. box' is used to send a signal directly from a guitar or bass into the console without first putting it through an amplifier and speaker and capturing the sound with a microphone.

ECHO The effect produced when sound is reflected off hard surfaces often reproduced artificially using electronic equipment (see DELAY).

EFFECTS (FX or DSP) SENDS Any outputs from a channel or console that can be connected to external equipment for extra sound processing. Usually effects sends are post fade so any level changes to the main signal also adjust the signal sent for processing.

EQUALISATION (EQ) Tone Controls

FADER Volume control, often a linear or slider type volume control.

FEEDBACK The squealing sound produced when a microphone picks up its own amplified sound from a loudspeaker.

F.O.H. Front of House. The speaker system which is used to project the sound from the stage to the audience. It is also used to describe the position, in front of the stage, where the main mixing console is situated.

GRAPHIC / GRAPHIC EQUALISER / GEQ An equaliser that uses rows of slider controls to adjust the sound. Each of the sliders will adjust one part of the frequency spectrum giving a visual display of which areas have been cut or boosted.

GROUND Earth

HERTZ (Hz) A measurement of frequency. 1Hz = 1 cycle per second.

HIGH (or TOP) The treble or high frequency content of a sound or the speakers (often compression drivers attached to horns or flares) used to reproduce it.

HOT The positive phase of a signal. Usually the red wire in a screened cable.

IMPEDANCE Similar to resistance, except that impedance also reflects the effect of any inductance or capacitance in the circuit.

STAGE MONITOR (FOLDBACK) Sound which is sent from the main mixing position back to the stage so the performers can hear it. Often, with a large sound system an entirely separate monitor (or foldback) system with a dedicated console is located on one side of the stage so the performers can communicate easily with the operator.

SERVICE INFORMATION

If you have a problem with your Studiomaster product or think it has developed a fault you should first carefully check the Trouble Shooting section in this guide. If this does not solve the problem or if the product is physically damaged, contact your local dealer or distributor for service details.

Should it be recommended you return the product to your nearest Studiomaster Service Centre you must first contact them.

You will be asked for the product type and serial number. You will then be given a Returns Authorisation (RA) number.

Pack the unit in its original carton to protect it from shipping damage.

You must have the Returns Authorisation number clearly marked on the outside of the carton or we may refuse the delivery.

Studiomaster cannot be held responsible for damage resulting from the equipment being packed incorrectly.

Label the equipment clearly with your name and address and include a clear description of the fault. The more information you supply helps the service engineer, minimising repair cost when out of warranty.

BLOCK DIAGRAM

CLUBXS06/CLUBXS08/10/12/16.SCH

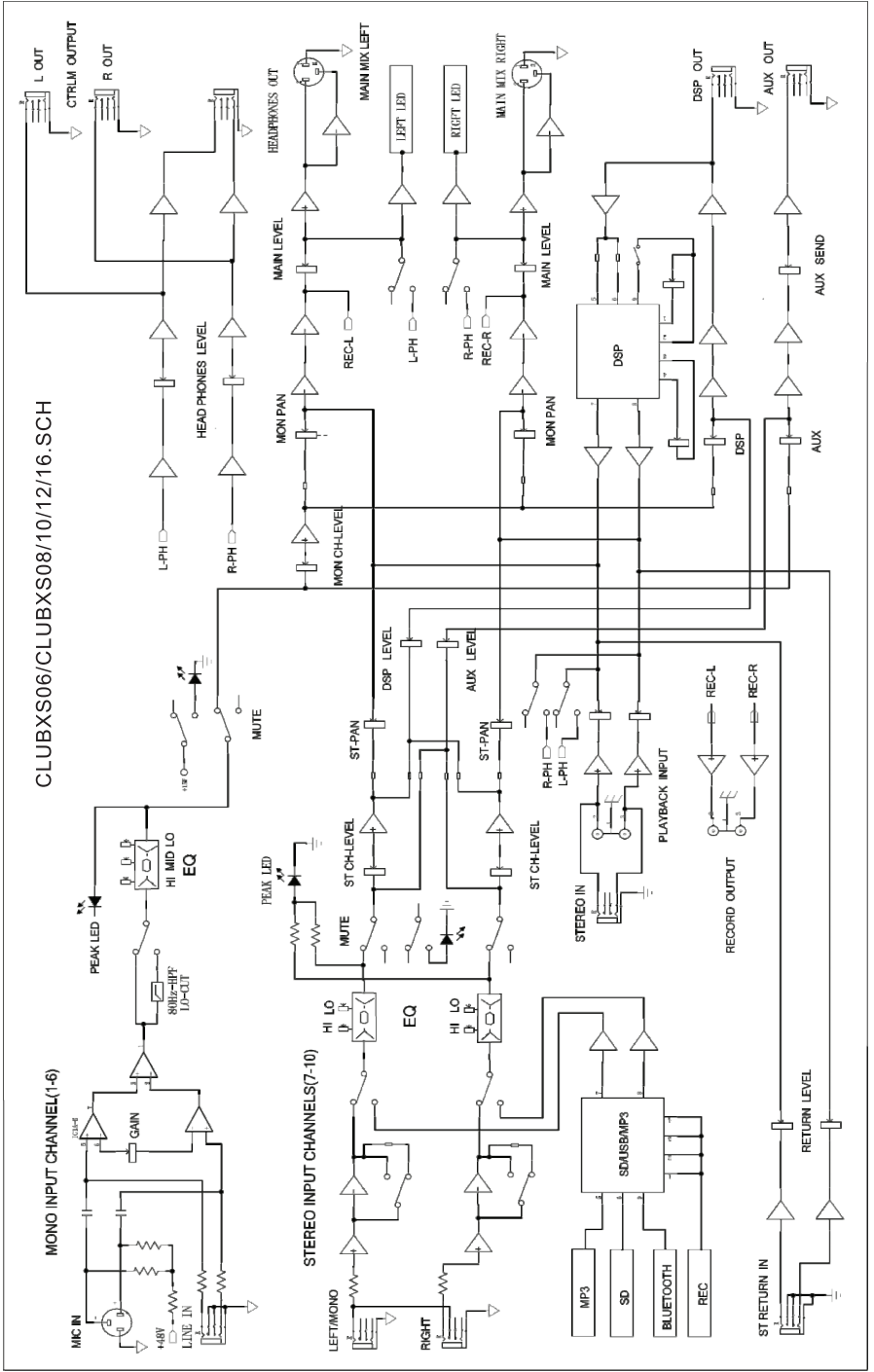

TECHNICAL SPECIFICATION

Mic input	Bal input
Frequency response	10 Hz to 30 kHz, +/-3 dB
THD(THD&N)	0.03% at +4 dBu, 22Hz-20kHz A-weighted
Compression	GAIN:0-9dB, THRESHOLD: 20dB [↓] 5dB
S/N ratio	(SNR)115 dB
Line in	Bal input
Frequency response	10 Hz to 30kHz, +/-3 dB
THD(THD&N)	0.005% at+4 dBu, 22Hz-20kHz A-weightde
Max gain	75 dBu MIC INPUT MAIN OUTPUT
Stereo input channel	
Line in	Bal/unbal
Frequency response	10 Hz to 55 kHz, +/-3 dB
THD(THD&N)	0.005% at +4 dBu, 22Hz-20kHz A-weighted
Impedance	
Mic input	1.4 kOhm
Line in	10 kOhm
Other inputs	10 kOhm or more
Recording output	1 kOhm
Other outputs	120 Ohm
Mono EQ	
HI	+/-15 dB @12 kHz
MID	+/-15 dB @2.5 kHz
LOW	+/-15 dB @45 Hz
Low cut filter	80 Hz, 18 dB/Oct.
Stereo EQ	
HI	+/-15 dB @12 kHz
LOW	+/-15 dB @60 Hz
DSP	A/D & D/A converter sample frequency 24-Bit, 16 programs
Main mix	
Noise (BUS noise)	Fader 0dB, all input channel knobs set to minimum, EQ knobs set to middle,;-100dBu(reference:+4dBu)
Max output	Bal: +27dBu; unbal: +22dBu 1/4" connector
	AUX: +22 dBu
	DSP: +22dBu
Power supply	100-240 VAC~50/60 Hz
Dimension(D*W*H)mm	CLUBXS06: 358X130X76 CLUBXS08: 358X280X76 CLUBXS10: 358X336X76 CLUBXS12: 358X392X76 CLUBXS16 ^t : 395X525X85
Net weight	CLUBXS06 : 3.5kg CLUBXS08 : 4kg CLUBXS10 : 4.5kg CLUBXS12 : 5kg CLUBXS16 ^t : 7.2kg

