

# devio

## INSTALLATION GUIDE

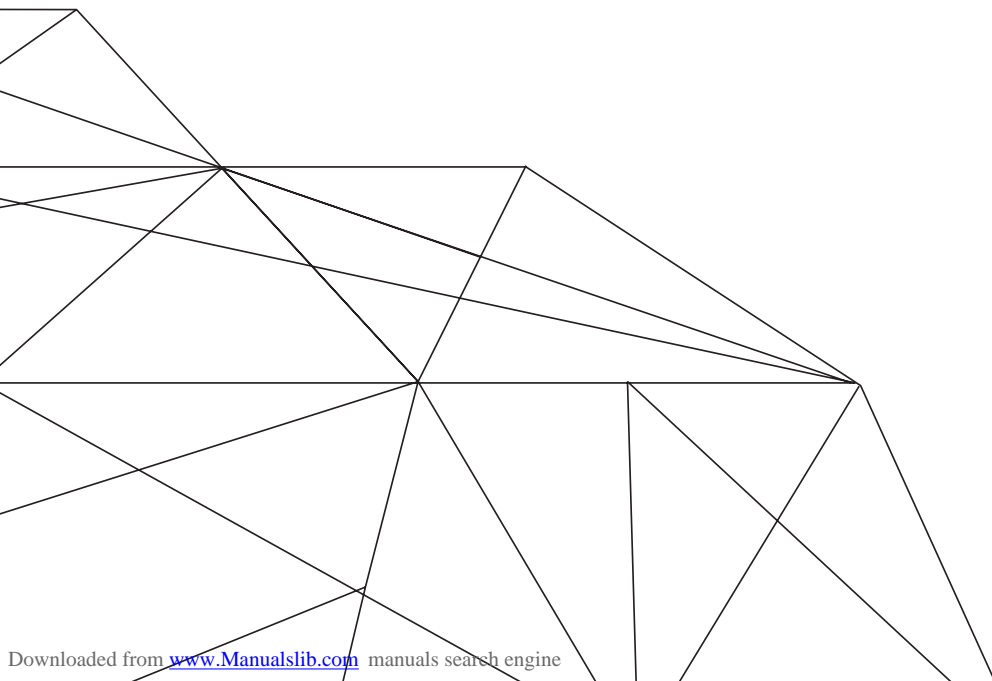

**biamp.**

585.0398.900  
MARCH 2018

# 1 |

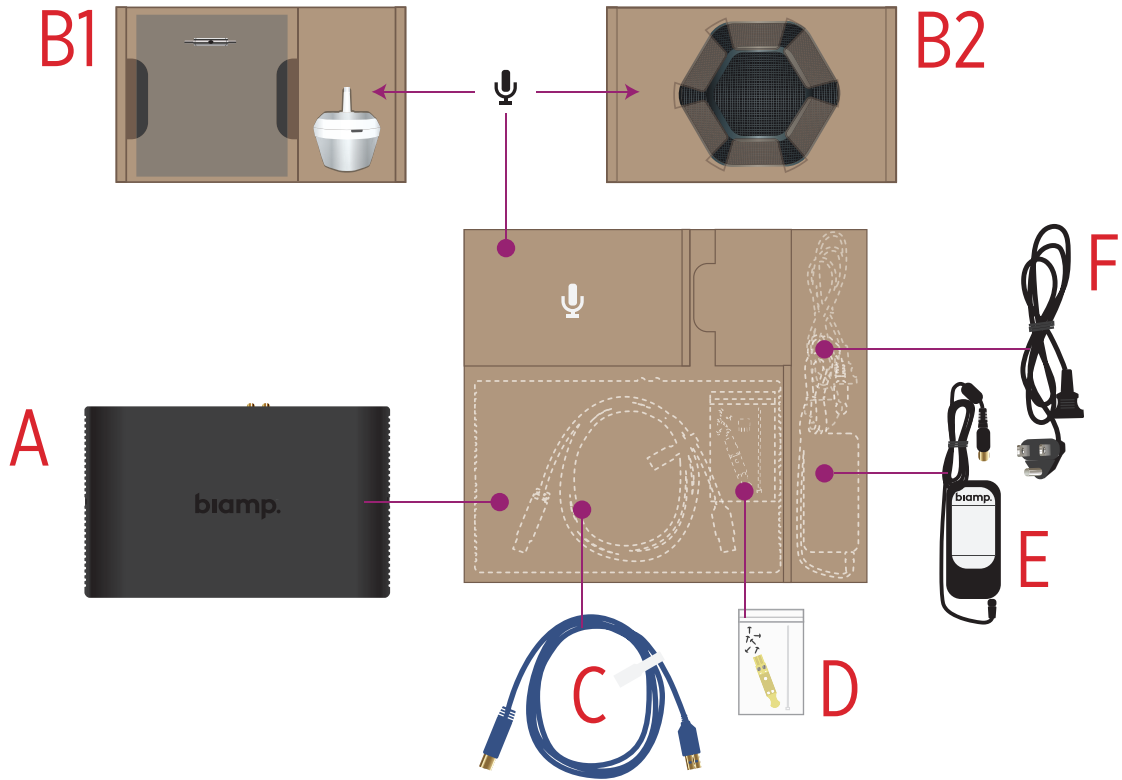

# 2 |

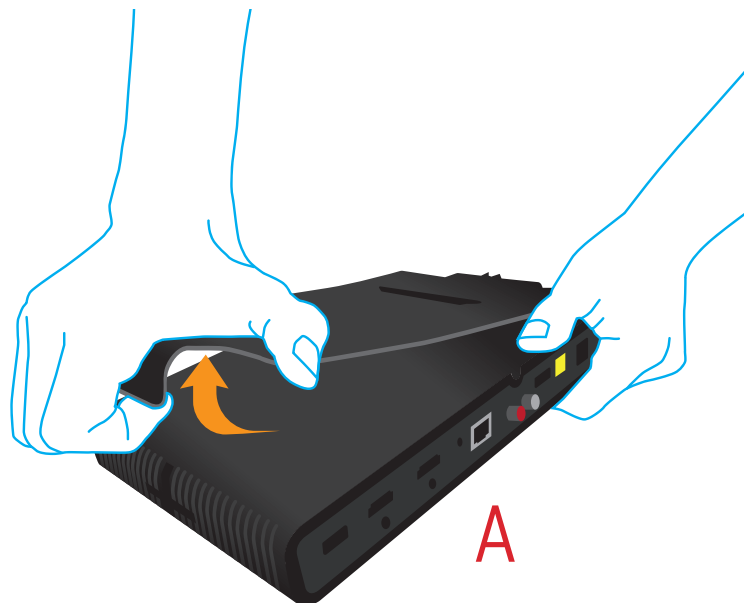

# 3 |

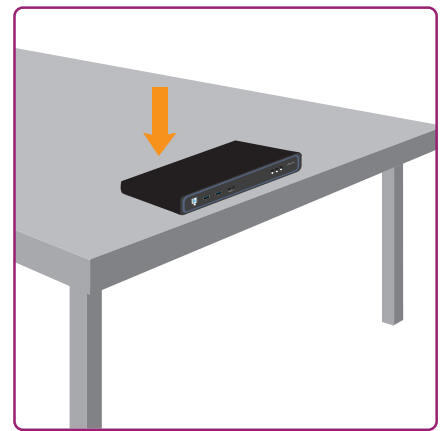
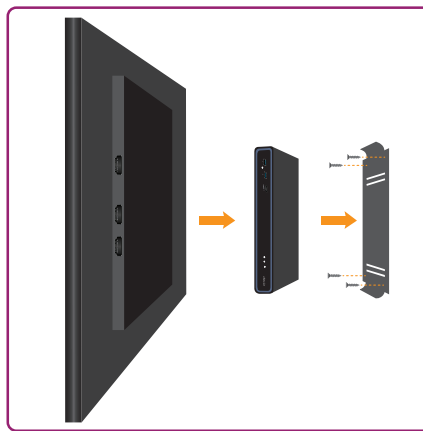
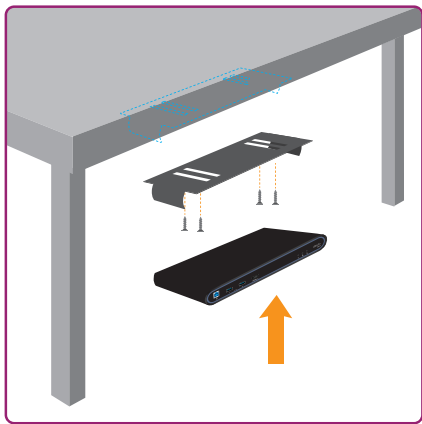
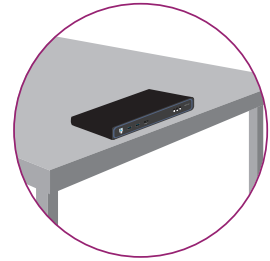
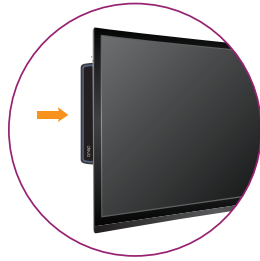
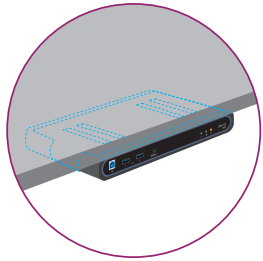

# 4 |

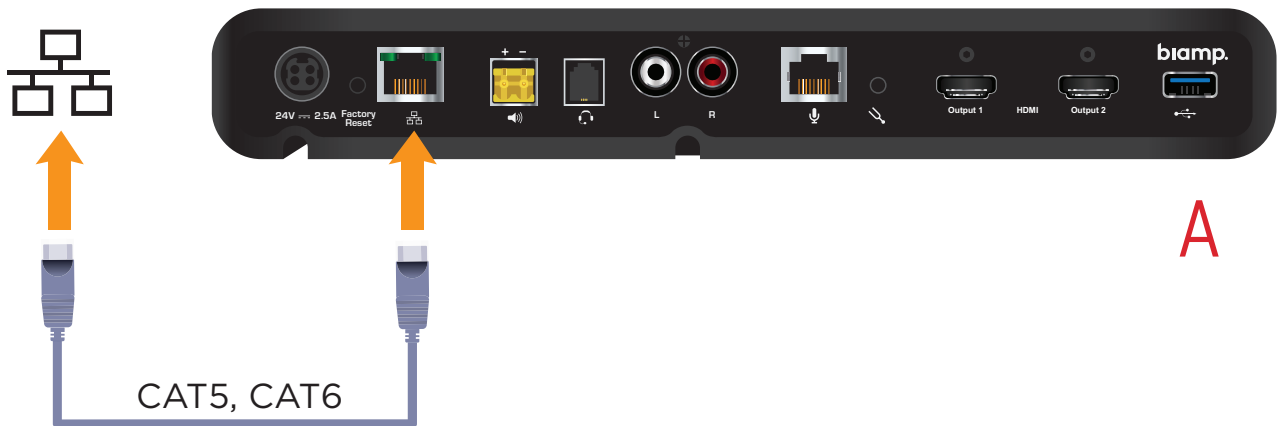

# 5 |

CR-1/SCR-20/SCR-25

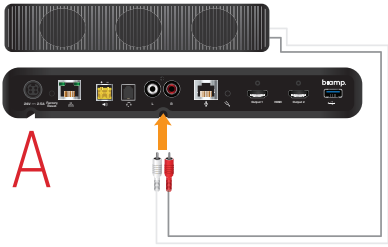

CR-1/SCR-20/SCR-25



SCR-20/SCR-25

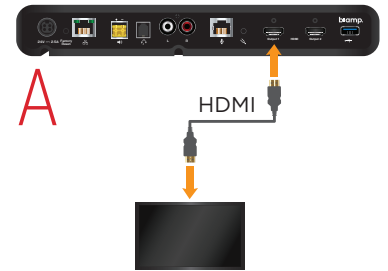

# 6 |

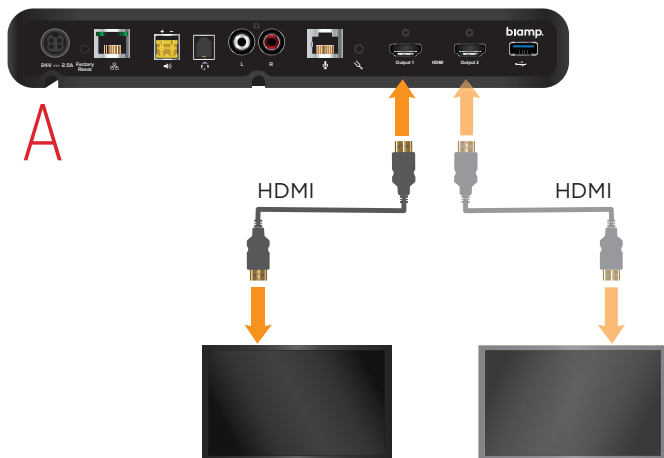

# 7 |



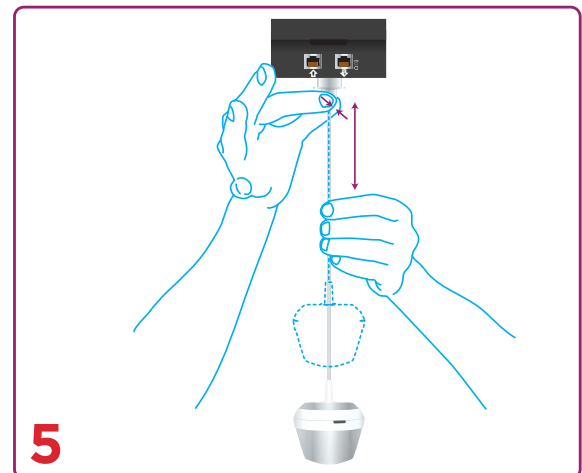
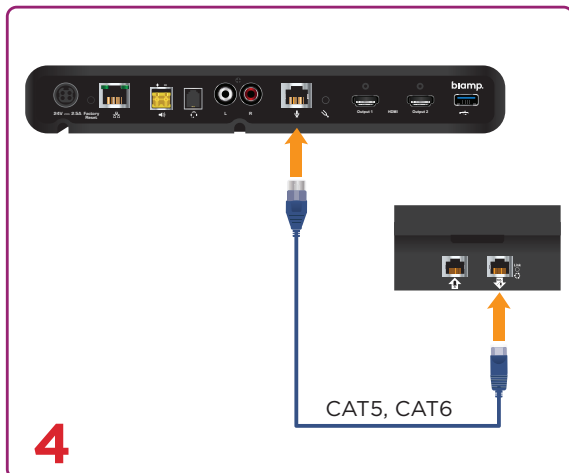
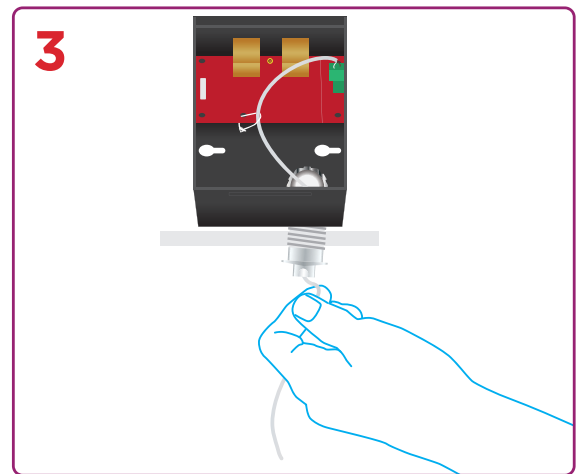
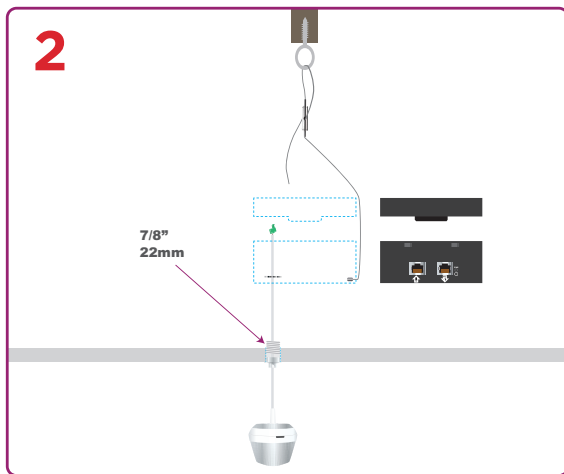
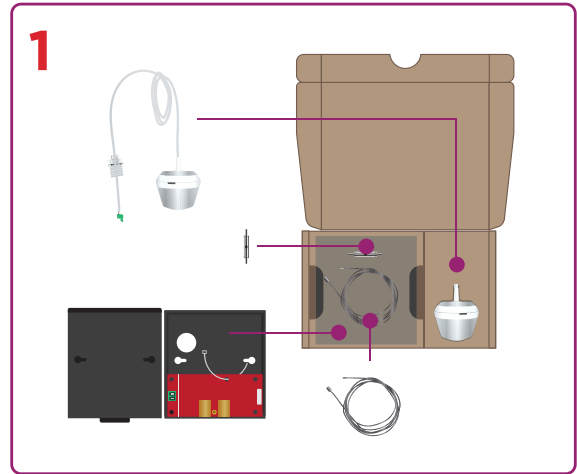

# 8B

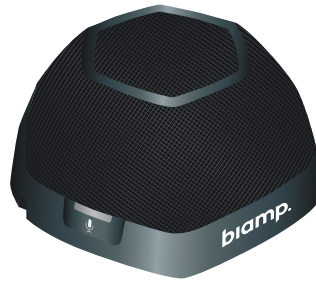

## B2

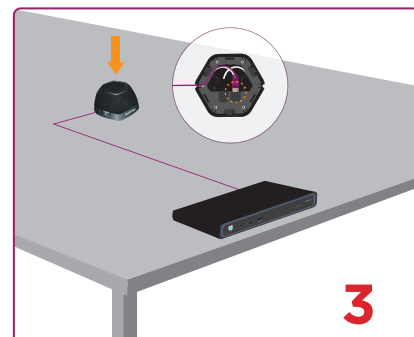
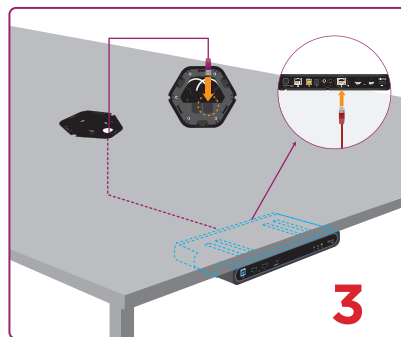
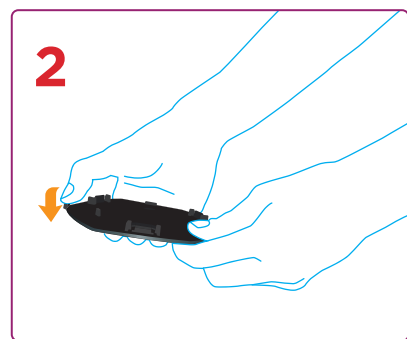
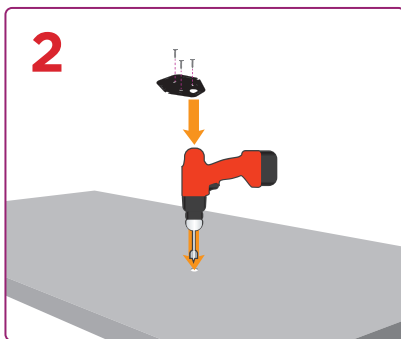
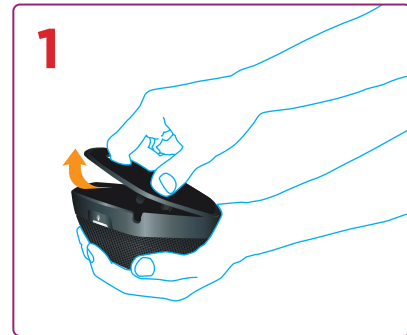
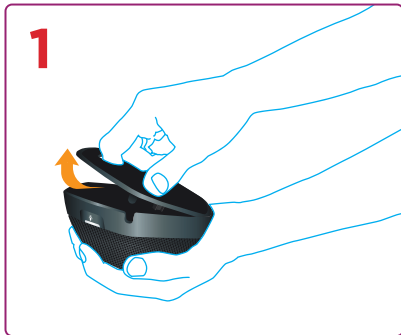
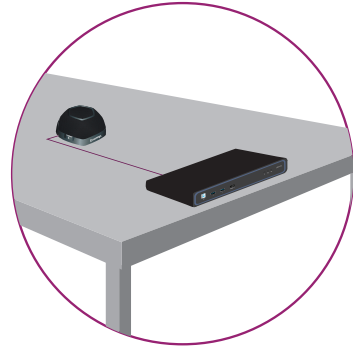
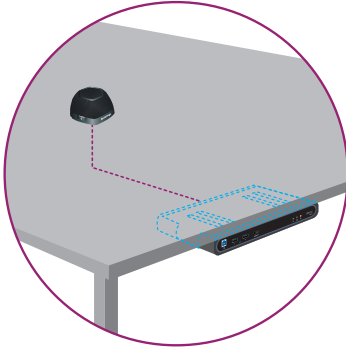

# 9 |

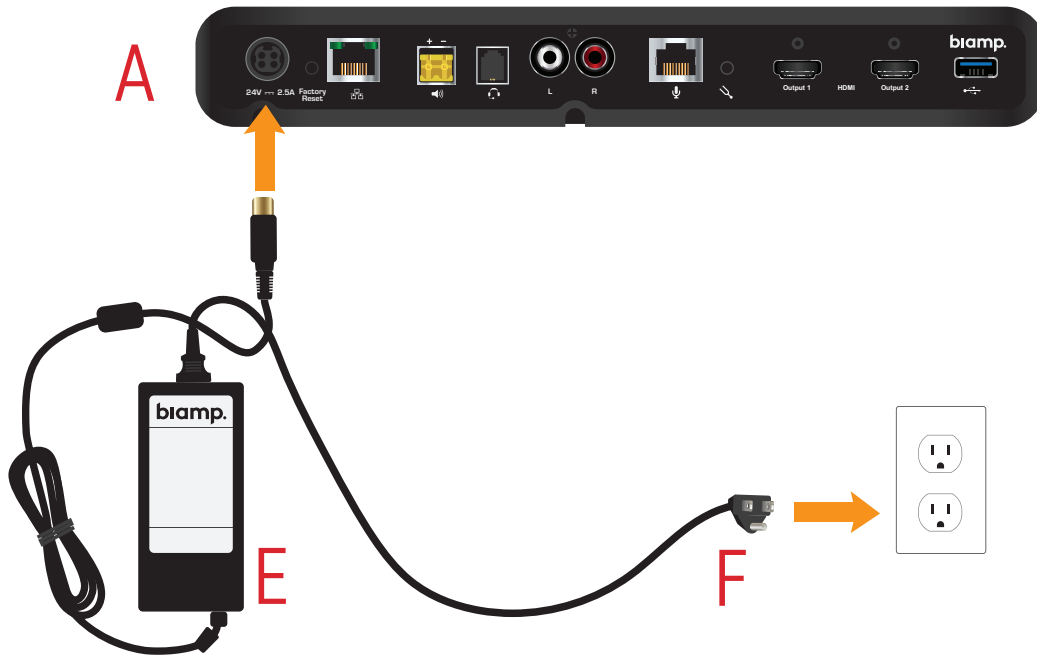

# 10 |



# 11A |

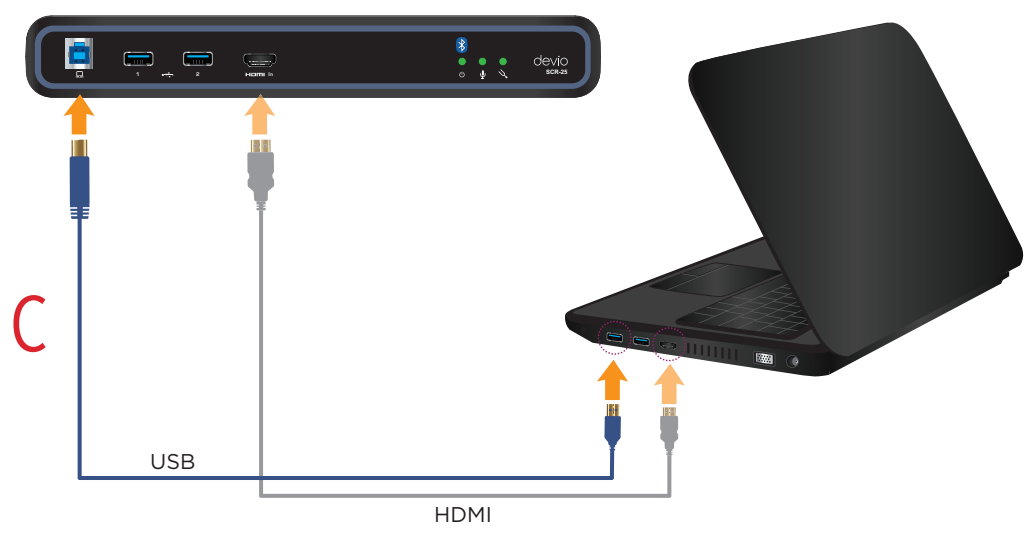

# 11B |



# 12 |

[bia.mp/deviosetup](http://bia.mp/deviosetup)



MOV



SW/FW



PDF

 [deviosupport@biamp.com](mailto:deviosupport@biamp.com)

 1.877.242.6796 (1 877 BIAMP XO) | +1.503.718.9257

**biamp.**