

# ***CAM3/ETZ*** ***CAM3/EMZ*** **USER MANUAL**

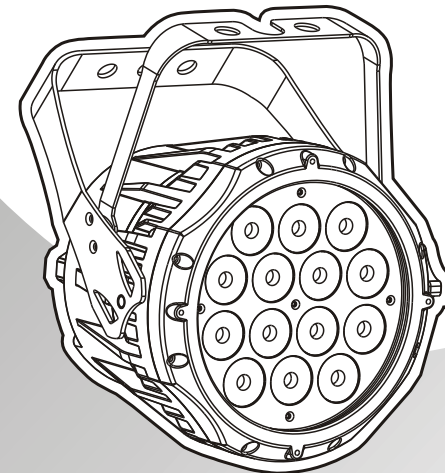

**SS358**

**MODELS:**  
SS358XCE/SS358XCET/SS358XCEM

 **SILVER STAR**  
*Professional Lighting*  
[www.yajiang.cn](http://www.yajiang.cn)  
RD-SS358-SM-00(SS-1)

# 1 PRODUCT (GENERAL)

## 1.1 TECHNICAL SPECIFICATIONS

### LED MODULE

Type	Model	Voltage	Operation Temperature	Weight	Dimensions 2 (mm)	Power (W)	IP
I	R:3Wx14 G:3Wx14 B:3Wx14 W:3Wx14	AC100~240V 50/60Hz	-20~45	4.8	245x205x245	65	IP2X
II	R:3Wx14 G:3Wx14 B:3Wx14 W:3Wx14						IP66
III	R:3Wx14 G:3Wx14 B:3Wx14 W:3Wx14						IP65

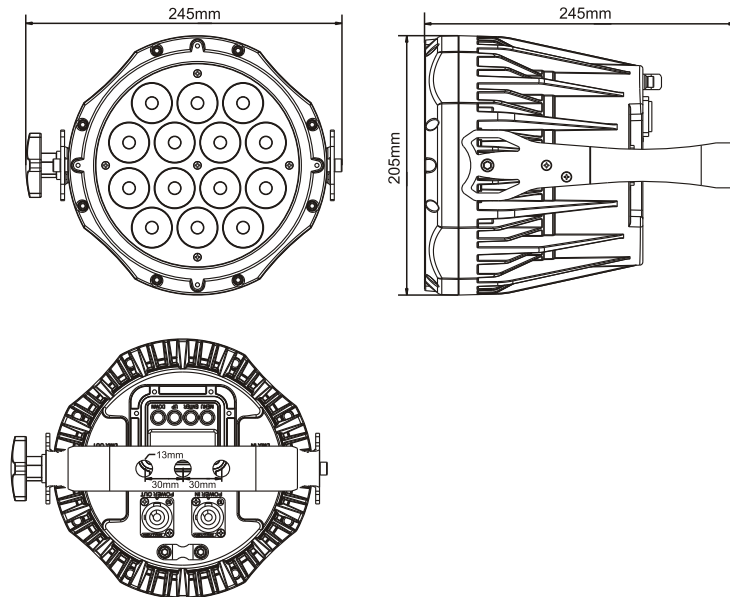

## ARC.2

CHANNEL	VALUE	FUNCTION
1	0 ↔ 255	RED
2	0 ↔ 255	GREEN
3	0 ↔ 255	BLUE
4	0 ↔ 255	WHITE

## AR2.D

CHANNEL	VALUE	FUNCTION
1	0 ↔ 255	DIMMER
2	0 ↔ 255	RED
3	0 ↔ 255	GREEN
4	0 ↔ 255	BLUE
5	0 ↔ 255	WHITE

## AR2.S

CHANNEL	VALUE	FUNCTION
1	0 ↔ 255	DIMMER
2	0 ↔ 255	RED
3	0 ↔ 255	GREEN
4	0 ↔ 255	BLUE
5	0 ↔ 255	WHITE
6	0 ↔ 255	STROBE

## 1.2 SAFETY WARNING

### IMPORTANT:

- This product must be installed by a qualified professional.
- All maintenance must be carried out by a qualified electrician.
- A minimum distance of 0.5m must be maintained between the equipment and a combustible surface.
- The product must always be operated in a well ventilated area.
- DO NOT stare directly into the LED light source.
- Always disconnect the power before carrying out any maintenance.
- The earth must always be connected to the ground.
- Ensure that all parts of the equipment are kept clean and free of dust.

## 2 INSTALLATION

### 2.1 MOUNTING

#### HANGING

The fixture can be mounted in a hanging position using the supporting bracket. The bracket should be secured to the mounting truss or structure using a standard mounting clamp. Please note that when hanging the unit a safety cable should also be used.

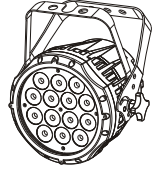

#### UPRIGHT

The fixture can be mounted in an upright or sitting position using the supporting brackets.

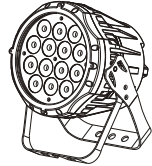

**NOTE**

The LED MODULE can be mounted at any angle and in any position. It is possible to further adjust the angle of the LED MODULE using the two adjustment knobs located on the side of the fixture.

### 2.2 POWER CONNECTIONS

@ 220V: 24 units may be connected in series

@ 120V: 12 units may be connected in series

CHANNEL	VALUE	FUNCTION
6		DIMMER SPEED
	0 ↔ 9	RETURN SETTINGS
	10 ↔ 29	NORMAL
	30 ↔ 69	DIM 1
	70 ↔ 129	DIM 2
	130 ↔ 189	DIM 3
	190 ↔ 255	DIM 4

## SSP

CHANNEL	VALUE	FUNCTION
1	0 ↔ 255	DIMMER
2	0 ↔ 255	RED
3	0 ↔ 255	GREEN
4	0 ↔ 255	BLUE
5	0 ↔ 255	WHITE
		SPECIAL STROBE
	0 ↔ 9	NO STROBE
	10 ↔ 99	STROBE ( SLOW TO FAST )
	100 ↔ 109	NO STROBE
	110 ↔ 179	LIGHTNING STROBE (SLOW TO FAST)
	180 ↔ 189	NO STROBE
	190 ↔ 255	RANDOM SROBE (SLOW TO FAST)
		CLASSIC STROBE
	0 ↔ 9	0
	10 ↔ 19	1
	20 ↔ 29	2
	30 ↔ 39	3
	40 ↔ 49	4
6	50 ↔ 59	5
	60 ↔ 69	6
	70 ↔ 79	7
	80 ↔ 89	8
	90 ↔ 99	9
	100 ↔ 109	10
	110 ↔ 119	11
	120 ↔ 129	12
	130 ↔ 139	13
	140 ↔ 149	14
	150 ↔ 159	15
	160 ↔ 169	16
	170 ↔ 179	17
	180 ↔ 189	18
	190 ↔ 199	19
	200 ↔ 255	20

## 2.3 SETTING UP WITH A DMX512 CONTROLLER

- Connect the DMX512 controller to the units in series.
- Each unit has 13 DMX channels so the DMX Addresses should increase by increments of 1, (Nx1)+1, (Nx2)+1, (Nx3)+1, ...
- The ID address has not been set so therefore when using the controller CH 10 must be inactive ( CH10=0 ).
- It is also possible to deactivate ID address selecting **【ID OFF】** from the **【Settings】** menu. on the fixture
- Each DMX Address may be used as many times as required.
- Any DMX address in the range from 001 to 512 may be used.

### Example:

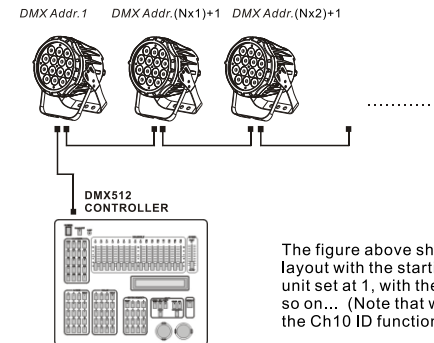

The figure above shows a simple DMX512 layout with the starting address of the first unit set at 1, with the second address set at (Nx1)+1 and so on... (Note that when used in this way, the Ch10 ID function must be inactive (CH10=0))

# 3 DISPLAY PANEL OPERATION

## 3.1 DISPLAY OPERATION

- 【 MENU 】 return to the previous menu.
- 【 ENTER 】 enter the currently selected menu.
- 【 UP 】 scroll down through the current menu list or decrease the value of the current function.
- 【 DOWN 】 scroll up through the current menu list or increase the value of the current function.

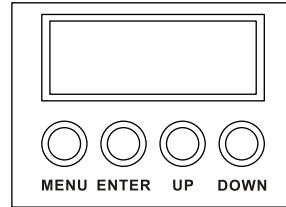

## 3.2 MENU MAP

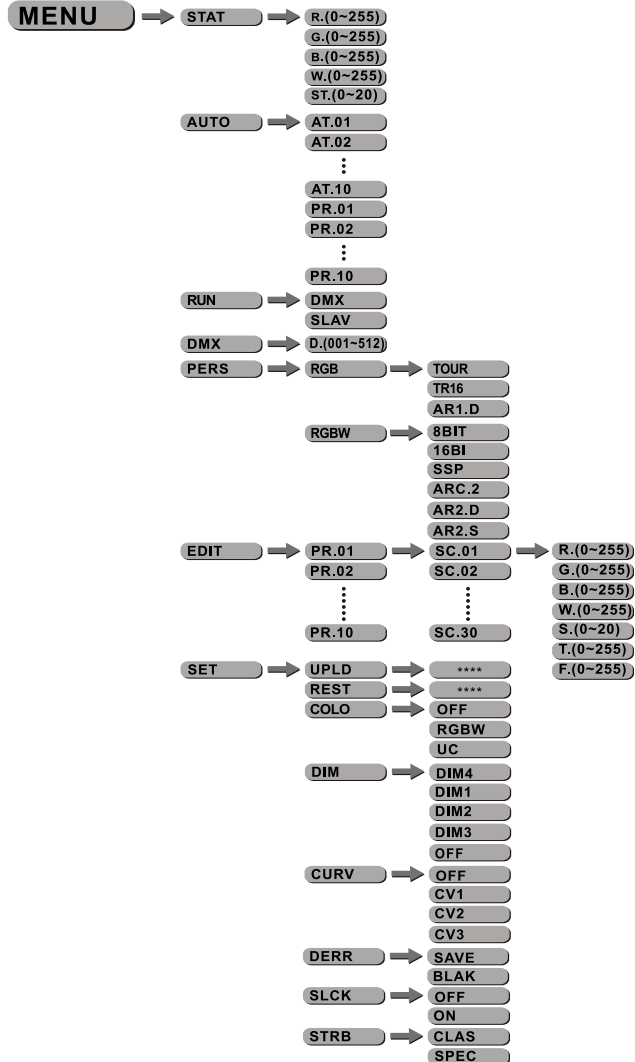

CHANNEL	VALUE	FUNCTION
13		AUTO
	0 ↔ 20	NO FUNCTION
	21 ↔ 30	AUTO01
	31 ↔ 40	AUTO02
	41 ↔ 50	AUTO03
	51 ↔ 60	AUTO04
	61 ↔ 70	AUTO05
	71 ↔ 80	AUTO06
	81 ↔ 90	AUTO07
	91 ↔ 100	AUTO08
	101 ↔ 110	AUTO09
	111 ↔ 120	AUTO10
	121 ↔ 130	CUSTOM01
	131 ↔ 140	CUSTOM02
141 ↔ 150	CUSTOM03	
151 ↔ 160	CUSTOM04	
161 ↔ 170	CUSTOM05	
171 ↔ 180	CUSTOM06	
181 ↔ 190	CUSTOM07	
191 ↔ 200	CUSTOM08	
201 ↔ 210	CUSTOM09	
211 ↔ 220	CUSTOM10	
221 ↔ 255	NO FUNCTION	
14		AUTO SPEED
	0 ↔ 255	SINCE THE WALKING SPEED (SLOW TO FAST)
15		DIMMER SPEED
	0 ↔ 9	RETURN SETTINGS
	10 ↔ 29	NORMAL
	30 ↔ 69	DIM 1
	70 ↔ 129	DIM 2
	130 ↔ 189	DIM 3
	190 ↔ 255	DIM 4

CHANNEL	VALUE	FUNCTION
		SPECIAL STROBE
	0 ↔ 9	NO STROBE
	10 ↔ 99	STROBE ( SLOW TO FAST )
	100 ↔ 109	NO STROBE
	110 ↔ 179	LIGHTNING STROBE (SLOW TO FAST)
	180 ↔ 189	NO STROBE
	190 ↔ 255	RANDOM SROBE (SLOW TO FAST)
		CLASSIC STROBE
	0 ↔ 9	0
	10 ↔ 19	1
	20 ↔ 29	2
	30 ↔ 39	3
	40 ↔ 49	4
	50 ↔ 59	5
	60 ↔ 69	6
	70 ↔ 79	7
	80 ↔ 89	8
	90 ↔ 99	9
	100 ↔ 109	10
	110 ↔ 119	11
	120 ↔ 129	12
	130 ↔ 139	13
	140 ↔ 149	14
	150 ↔ 159	15
	160 ↔ 169	16
	170 ↔ 179	17
	180 ↔ 189	18
	190 ↔ 199	19
	200 ↔ 255	20

12

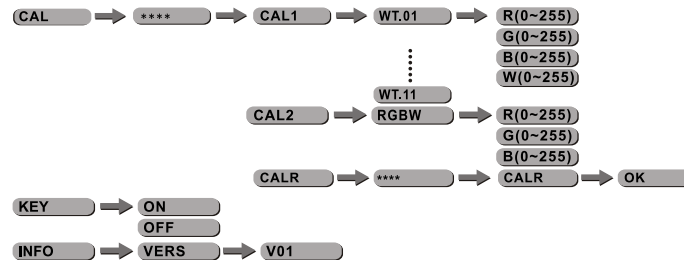

### 3.3 EDIT STATIC COLOUR



- Combine **Red** , **Green** and **Blue** to create an infinite range of colors (0-255)
- Set the value of the **Strobe** (0-20Hz)

### 3.4 ACTIVATING AUTO PROGRAMS

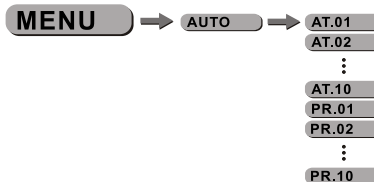

- Select the target **AUTO** program and press **ENTER** .
- Programs **AT.01** to **AT.10** are fully pre-programmed and will not be altered by changes in **EDIT** mode.
- Programs **PR.01** to **PR.10** are fully pre-programmed and can be edited in **EDIT** mode.

### 3.5 RUN MODE



- Enter the **RUN** mode to set working mode.
- **DMX** mode is for using the DMX512 controller to control the fixtures.
- **SLAV** mode is for Master -- Slave operation.

### 3.6 DMX512 SETTINGS



- Enter the **DMX** mode to set the DMX ADDRESS.

### 3.7 PERSONALITY

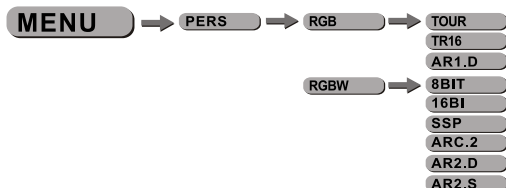

- Enter the **PERSONALITY** mode to select DMX mode: **TOUR** **TR16** , **AR1.D** , **8BIT** , **16BI** , **SSP** , **ARC.2** , **ARC.D** , **AR2.S**

### 3.8 EDITING CUSTOM PROGRAMS

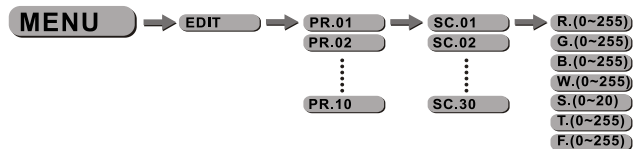

- Enter the **EDIT** mode to edit the custom programs **PR.01** to **PR.10** .
- Each custom program has 30 steps that can be edited.
- Each step allows the creation of a scene using RED **Red** , GREEN **Green** , BLUE **Blue** , **STRB** **Strb** , TIME **Time** & FADE **Fade** .

### 16BI

CHANNEL	VALUE	FUNCTION
1	0 ↔ 255	MASTER DIMMER
2	0 ↔ 255	MASTER DIMMER FINE
3	0 ↔ 255	RED (C11 SELECT CUSTOM 01~10,CH3 CONTROL TIME)
4	0 ↔ 255	RED FINE (C11 SELECT CUSTOM 01~10,CH4 CONTROL FADE)
5	0 ↔ 255	GREEN
6	0 ↔ 255	GREEN FINE
7	0 ↔ 255	BLUE
8	0 ↔ 255	BLUE FINE
9	0 ↔ 255	WHITE
10	0 ↔ 255	WHITE FINE
		COLOR MACRO & WHITE
	0 ↔ 10	NO FUNCTION
	11 ↔ 30	RED 100% / GREEN UP / BLUE 0%
	31 ↔ 50	RED DOWN / GREEN 100% / BLUE 0%
	51 ↔ 70	RED 0% / GREEN 100% / BLUE UP
	71 ↔ 90	RED 0% / GREEN DOWN / BLUE 100%
	91 ↔ 110	RED UP / GREEN 0% / BLUE 100%
	111 ↔ 130	RED 100% / GREEN 0% / BLUE DOWN
	131 ↔ 150	RED 100% / GREEN UP / BLUE UP
	151 ↔ 170	RED DOWN / GREEN DOWN / BLUE 100%
	171 ↔ 200	RED 100% / GREEN 100% / BLUE 100%
11	201 ↔ 205	WHITE1 : 3200K
	206 ↔ 210	WHITE2 : 3400K
	211 ↔ 215	WHITE3 : 4200K
	216 ↔ 220	WHITE4 : 4900K
	221 ↔ 225	WHITE5 : 5600K
	226 ↔ 230	WHITE6 : 5900K
	231 ↔ 235	WHITE7 : 6500K
	236 ↔ 240	WHITE8 : 7200K
	241 ↔ 245	WHITE9 : 8000K
	246 ↔ 250	WHITE10 : 8500K
	251 ↔ 255	WHITE11 : 10000K



CHANNEL	VALUE	FUNCTION
8		AUTO
	0 ↔ 20	NO FUNCTION
	21 ↔ 30	AUTO01
	31 ↔ 40	AUTO02
	41 ↔ 50	AUTO03
	51 ↔ 60	AUTO04
	61 ↔ 70	AUTO05
	71 ↔ 80	AUTO06
	81 ↔ 90	AUTO07
	91 ↔ 100	AUTO08
	101 ↔ 110	AUTO09
	111 ↔ 120	AUTO10
	121 ↔ 130	CUSTOM01
	131 ↔ 140	CUSTOM02
	141 ↔ 150	CUSTOM03
	151 ↔ 160	CUSTOM04
	161 ↔ 170	CUSTOM05
	171 ↔ 180	CUSTOM06
	181 ↔ 190	CUSTOM07
	191 ↔ 200	CUSTOM08
	201 ↔ 210	CUSTOM09
	211 ↔ 220	CUSTOM10
221 ↔ 255	NO FUNCTION	
9		AUTO SPEED
	0 ↔ 255	SINCE THE WALKING SPEED (SLOW TO FAST)
10		DIMMER SPEED
	0 ↔ 9	RETURN SETTINGS
	10 ↔ 29	NORMAL
	30 ↔ 69	DIM 1
	70 ↔ 129	DIM 2
	130 ↔ 189	DIM 3
	190 ↔ 255	DIM 4

### 3.9 SPECIAL SETTINGS

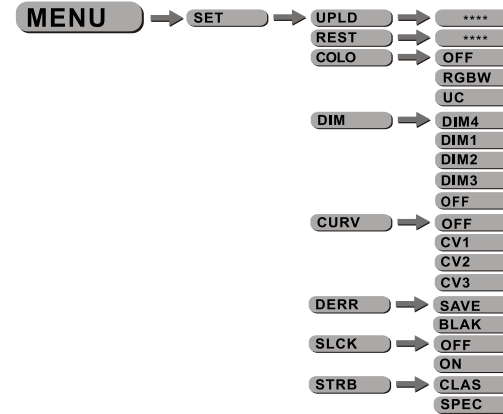

- Select [UPLD] to upload the custom programs from the current MASTER unit to the SLAVE units.
- In order to reset custom modes to default values select [REST].
- [COLO] is for activate/unactivate the color calibration functions. When [RGBW] is selected, on RGB = 255,255,255, the color is displayed as calibrated in CAL2 -- RGBW. When [COLR] is set [OFF], on RGB = 255,255,255, the RGB values are not adjusted and the output is most powerful. When [UC] is selected, the RGB output are adjusted to a standard preset universal color which balances fixtures from different generations.
- Select [DIM1], [DIM2], [DIM3] or [DIM4] for different dimming speeds. ([DIM4] is the slowest dimming speed)
- [CURV] allows the user to adjust the shape of the dimming curve. See the CURV chart to understand more about actual dimming curves.
- [DERR] Choose [Save] in order to save the last DMX data in case of DMX signal error. Choose [Black] in order to blackout in case of DMX signal error.
- [SLCK] is used to lock the settings menu. When [SLCK] is set to [ON] then user must insert passcode (UP+DOWN+UP+DOWN) in order to access the settings menu.
- [STRB] This fixture allows for two different strobe personality settings, [CLAS] strobe or [SPEC] strobe. The [STRB] settings are only valid in the DMX personalities [TOUR], [AR2.S] and [TR16]

## CURV dimming

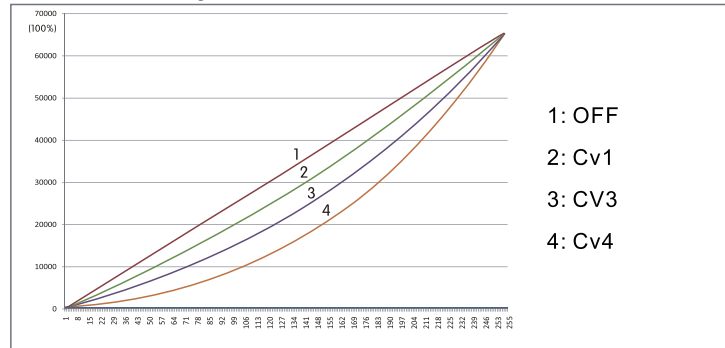

## 3.10 BALANCE PARAMETERS AND CORRECTION MENU DISPLAY

Press **【MENU】** button to enter the password confirmation, to enter the correct password < UP + DOWN + UP + DOWN >  
Key, press the **【MENU】** in, the correct password will enter show submenu

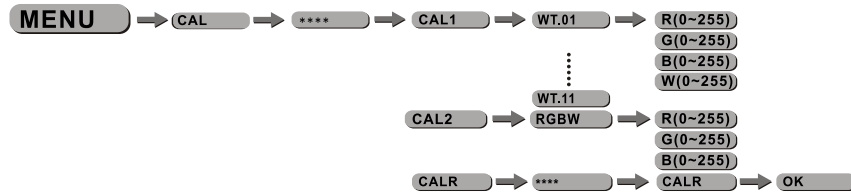

- Enter the **【CAL1】** to select white color of different color temperature.
- There are 11 pre-programmed White colors can be edited by using **【Red】** , **【Green】** & **【Blue】** .
- Enter the **【CAL2】** to adjust the RGB parameter to make different whites.
- When the new setting is activated, the DMX controller choose RGB = 255,255,255 the white color will be made by the actual RGB values on the **【CAL2】** .

CHANNEL	VALUE	FUNCTION
		SPECIAL STROBE
	0 ↔ 9	NO STROBE
	10 ↔ 99	STROBE ( SLOW TO FAST )
	100 ↔ 109	NO STROBE
	110 ↔ 179	LIGHTNING STROBE (SLOW TO FAST)
	180 ↔ 189	NO STROBE
	190 ↔ 255	RANDOM SROBE (SLOW TO FAST)
		CLASSIC STROBE
	0 ↔ 9	0
	10 ↔ 19	1
	20 ↔ 29	2
	30 ↔ 39	3
	40 ↔ 49	4
	50 ↔ 59	5
	60 ↔ 69	6
	70 ↔ 79	7
	80 ↔ 89	8
	90 ↔ 99	9
	100 ↔ 109	10
	110 ↔ 119	11
	120 ↔ 129	12
	130 ↔ 139	13
	140 ↔ 149	14
	150 ↔ 159	15
	160 ↔ 169	16
	170 ↔ 179	17
	180 ↔ 189	18
	190 ↔ 199	19
	200 ↔ 255	20

7

## 8BIT

CHANNEL	VALUE	FUNCTION
1	0 ↔ 255	MASTER DIMMER
2	0 ↔ 255	RED (CH7 SELECT CUSTOM 01-10 , CH2 CONTROL TIME)
3	0 ↔ 255	GREEN (CH7 SELECT CUSTOM 01-10 , CH3CONTROL FADE)
4	0 ↔ 255	BLUE
5	0 ↔ 255	WHITE
		COLOR MACRO & WHITE
	0 ↔ 10	NO FUNCTION
	11 ↔ 30	RED 100% / GREEN UP / BLUE 0%
	31 ↔ 50	RED DOWN / GREEN 100% / BLUE 0%
	51 ↔ 70	RED 0% / GREEN 100% / BLUE UP
	71 ↔ 90	RED 0% / GREEN DOWN / BLUE 100%
	91 ↔ 110	RED UP / GREEN 0% / BLUE 100%
	111 ↔ 130	RED 100% / GREEN 0% / BLUE DOWN
	131 ↔ 150	RED 100% / GREEN UP/ BLUE UP
	151 ↔ 170	RED DOWN / GREEN DOEN / BLUE 100%
	171 ↔ 200	RED 100% / GREEN 100% / BLUE 100%
6	201 ↔ 205	WHITE1 : 3200K
	206 ↔ 210	WHITE2 : 3400K
	211 ↔ 215	WHITE3 : 4200K
	216 ↔ 220	WHITE4 : 4900K
	221 ↔ 225	WHITE5 : 5600K
	226 ↔ 230	WHITE6 : 5900K
	231 ↔ 235	WHITE7 : 6500K
	236 ↔ 240	WHITE8 : 7200K
	241 ↔ 245	WHITE9 : 8000K
	246 ↔ 250	WHITE10 : 8500K
	251 ↔ 255	WHITE11 : 10000K

## 3.11 ACTIVATE THE PASSWORD



- Enter the **KEY** mode to select whether the access password is on or off.
- When the fixture is set as PASS **ON** , after 30 seconds or turn on the fixture next time, the fixture will need an access password to enter the display menu control.

**Note:** The factory access password is **UP** + **DOWN** + **UP** + **DOWN** , then press **ENTER** to confirm the access.

## 3.12 INFO



- Press **ENTER** and go to **INFO** ,you can check **VERSION** .

# 4 USING A DMX512 CONTROLLER

## 4.1 CHANNEL ASSIGNMENT

- Note: This product have eleven DMX512 channel configuration: TOUR / TR16 / AR1.D/8BIT/16BI/SSP/ARC.2/AR2.D/AR2.S

### TOUR

CHANNEL	VALUE	FUNCTION
1	0 ↔ 255	MASTER DIMMER
2	0 ↔ 255	RED (CH7 SELECT CUSTOM 01-10 , CH2 CONTROL TIME)
3	0 ↔ 255	GREEN (CH7 SELECT CUSTOM 01-10 , CH3CONTROL FADE)
4	0 ↔ 255	BLUE
		COLOR MACRO & WHITE
	0 ↔ 10	NO FUNCTION
	11 ↔ 30	RED 100% / GREEN UP / BLUE 0%
	31 ↔ 50	RED DOWN / GREEN 100% / BLUE 0%
	51 ↔ 70	RED 0% / GREEN 100% / BLUE UP
	71 ↔ 90	RED 0% / GREEN DOWN / BLUE 100%
	91 ↔ 110	RED UP / GREEN 0% / BLUE 100%
	111 ↔ 130	RED 100% / GREEN 0% / BLUE DOWN
	131 ↔ 150	RED 100% / GREEN UP/ BLUE UP
	151 ↔ 170	RED DOWN / GREEN DOEN / BLUE 100%
	171 ↔ 200	RED 100% / GREEN 100% / BLUE 100%
5	201 ↔ 205	WHITE1 : 3200K
	206 ↔ 210	WHITE2 : 3400K
	211 ↔ 215	WHITE3 : 4200K
	216 ↔ 220	WHITE4 : 4900K
	221 ↔ 225	WHITE5 : 5600K
	226 ↔ 230	WHITE6 : 5900K
	231 ↔ 235	WHITE7 : 6500K
	236 ↔ 240	WHITE8 : 7200K
	241 ↔ 245	WHITE9 : 8000K
	246 ↔ 250	WHITE10 : 8500K
	251 ↔ 255	WHITE11 : 10000K

CHANNEL	VALUE	FUNCTION
		AUTO
	0 ↔ 20	NO FUNCTION
	21 ↔ 30	AUTO01
	31 ↔ 40	AUTO02
	41 ↔ 50	AUTO03
	51 ↔ 60	AUTO04
	61 ↔ 70	AUTO05
	71 ↔ 80	AUTO06
11	81 ↔ 90	AUTO07
	91 ↔ 100	AUTO08
	101 ↔ 110	AUTO09
	111 ↔ 120	AUTO10
	121 ↔ 130	CUSTOM01
	131 ↔ 140	CUSTOM02
	141 ↔ 150	CUSTOM03
	151 ↔ 160	CUSTOM04
	161 ↔ 170	CUSTOM05
	171 ↔ 180	CUSTOM06
	181 ↔ 190	CUSTOM07
	191 ↔ 200	CUSTOM08
	201 ↔ 210	CUSTOM09
	211 ↔ 220	CUSTOM10
	221 ↔ 255	NO FUNCTION
12		AUTO SPEED
	0 ↔ 255	SINCE THE WALKING SPEED (SLOW TO FAST)
		DIMMER SPEED
	0 ↔ 9	RETURN SETTINGS
	10 ↔ 29	NORMAL
	30 ↔ 69	DIM 1
13	70 ↔ 129	DIM 2
	130 ↔ 189	DIM 3
	190 ↔ 255	DIM 4

### AR1.D

CHANNEL	VALUE	FUNCTION
1	0 ↔ 255	DIMMER
2	0 ↔ 255	RED
3	0 ↔ 255	GREEN
4	0 ↔ 255	BLUE

CHANNEL	VALUE	FUNCTION
10		SPECIAL STROBE
	0 ↔ 9	NO STROBE
	10 ↔ 99	STROBE ( SLOW TO FAST )
	100 ↔ 109	NO STROBE
	110 ↔ 179	LIGHTNING STROBE (SLOW TO FAST )
	180 ↔ 189	NO STROBE
	190 ↔ 255	RANDOM SROBE (SLOW TO FAST )
		CLASSIC STROBE
	0 ↔ 9	0
	10 ↔ 19	1
	20 ↔ 29	2
	30 ↔ 39	3
	40 ↔ 49	4
	50 ↔ 59	5
	60 ↔ 69	6
	70 ↔ 79	7
	80 ↔ 89	8
	90 ↔ 99	9
	100 ↔ 109	10
	110 ↔ 119	11
120 ↔ 129	12	
130 ↔ 139	13	
140 ↔ 149	14	
150 ↔ 159	15	
160 ↔ 169	16	
170 ↔ 179	17	
180 ↔ 189	18	
190 ↔ 199	19	
200 ↔ 255	20	

CHANNEL	VALUE	FUNCTION
6		SPECIAL STROBE
	0 ↔ 9	NO STROBE
	10 ↔ 99	STROBE ( SLOW TO FAST )
	100 ↔ 109	NO STROBE
	110 ↔ 179	LIGHTNING STROBE (SLOW TO FAST )
	180 ↔ 189	NO STROBE
	190 ↔ 255	RANDOM SROBE (SLOW TO FAST )
		CLASSIC STROBE
	0 ↔ 9	0
	10 ↔ 19	1
	20 ↔ 29	2
	30 ↔ 39	3
	40 ↔ 49	4
	50 ↔ 59	5
	60 ↔ 69	6
	70 ↔ 79	7
	80 ↔ 89	8
	90 ↔ 99	9
	100 ↔ 109	10
	110 ↔ 119	11
120 ↔ 129	12	
130 ↔ 139	13	
140 ↔ 149	14	
150 ↔ 159	15	
160 ↔ 169	16	
170 ↔ 179	17	
180 ↔ 189	18	
190 ↔ 199	19	
200 ↔ 255	20	

CHANNEL	VALUE	FUNCTION
		AUTO
	0 ↔ 20	NO FUNCTION
	21 ↔ 30	AUTO01
	31 ↔ 40	AUTO02
	41 ↔ 50	AUTO03
	51 ↔ 60	AUTO04
	61 ↔ 70	AUTO05
	71 ↔ 80	AUTO06
7	81 ↔ 90	AUTO07
	91 ↔ 100	AUTO08
	101 ↔ 110	AUTO09
	111 ↔ 120	AUTO10
	121 ↔ 130	CUSTOM01
	131 ↔ 140	CUSTOM02
	141 ↔ 150	CUSTOM03
	151 ↔ 160	CUSTOM04
	161 ↔ 170	CUSTOM05
	171 ↔ 180	CUSTOM06
	181 ↔ 190	CUSTOM07
	191 ↔ 200	CUSTOM08
	201 ↔ 210	CUSTOM09
	211 ↔ 220	CUSTOM10
	221 ↔ 255	NO FUNCTION
8		AUTO SPEED
	0 ↔ 255	SINCE THE WALKING SPEED (SLOW TO FAST)
		DIMMER SPEED
	0 ↔ 9	RETURN SETTINGS
	10 ↔ 29	NORMAL
	30 ↔ 69	DIM 1
9	70 ↔ 129	DIM 2
	130 ↔ 189	DIM 3
	190 ↔ 255	DIM 4

### TR16

CHANNEL	VALUE	FUNCTION
1	0 ↔ 255	MASTER DIMMER
2	0 ↔ 255	MASTER DIMMER FINE
3	0 ↔ 255	RED (C11 SELECT CUSTOM 01~10, CH3 CONTROL TIME)
4	0 ↔ 255	RED FINE (C11 SELECT CUSTOM 01~10, CH4 CONTROL FADE)
5	0 ↔ 255	GREEN
6	0 ↔ 255	GREEN FINE
7	0 ↔ 255	BLUE
8	0 ↔ 255	BLUE FINE
		COLOR MACRO & WHITE
	0 ↔ 10	NO FUNCTION
	11 ↔ 30	RED 100% / GREEN UP / BLUE 0%
	31 ↔ 50	RED DOWN / GREEN 100% / BLUE 0%
	51 ↔ 70	RED 0% / GREEN 100% / BLUE UP
	71 ↔ 90	RED 0% / GREEN DOWN / BLUE 100%
	91 ↔ 110	RED UP / GREEN 0% / BLUE 100%
	111 ↔ 130	RED 100% / GREEN 0% / BLUE DOWN
	131 ↔ 150	RED 100% / GREEN UP / BLUE UP
	151 ↔ 170	RED DOWN / GREEN DOWN / BLUE 100%
	171 ↔ 200	RED 100% / GREEN 100% / BLUE 100%
9	201 ↔ 205	WHITE1 : 3200K
	206 ↔ 210	WHITE2 : 3400K
	211 ↔ 215	WHITE3 : 4200K
	216 ↔ 220	WHITE4 : 4900K
	221 ↔ 225	WHITE5 : 5600K
	226 ↔ 230	WHITE6 : 5900K
	231 ↔ 235	WHITE7 : 6500K
	236 ↔ 240	WHITE8 : 7200K
	241 ↔ 245	WHITE9 : 8000K
	246 ↔ 250	WHITE10 : 8500K
	251 ↔ 255	WHITE11 : 10000K