

MIPRO®

MI-58T / MI-58TD

5.8 GHz Digital Stereo Transmitter

User Guide



I. Part Names

MI-58T

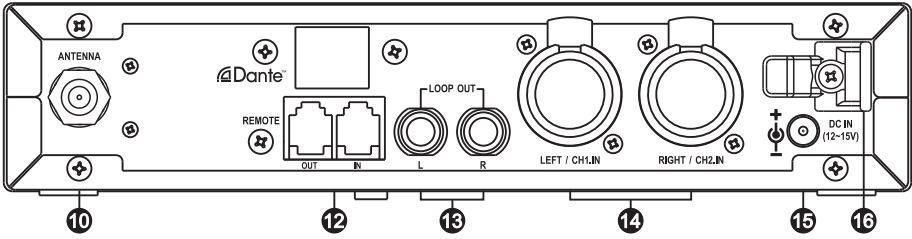
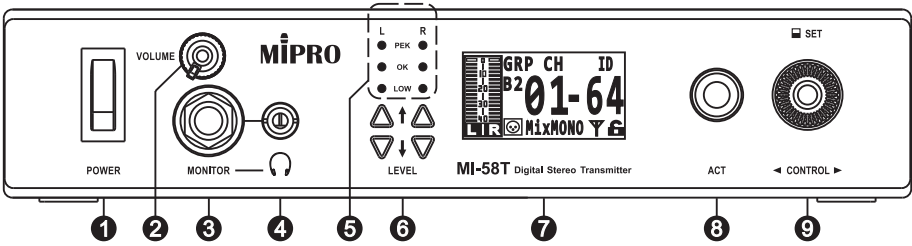

MI-58TD

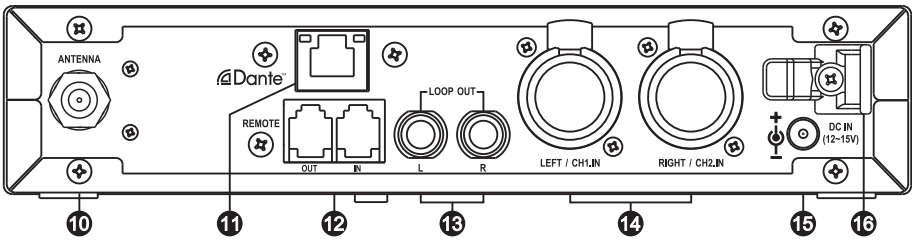
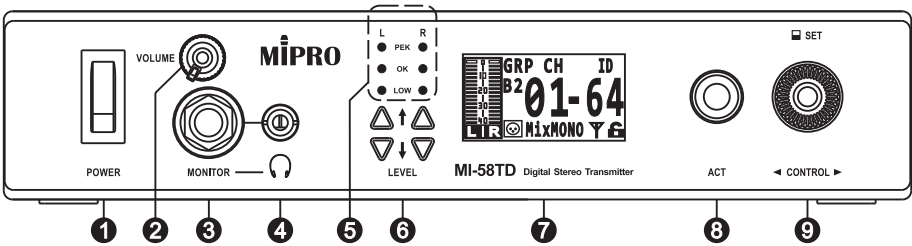

- ❶ POWER: AC Power Switch
- ❷ VOLUME: Headphone Volume Control
- ❸ MONITOR: 6.3 Ø Headphone Jack
- ❹ MONITOR: 3.5 Ø Headphone Jack
- ❺ Left / Right Quality Indicator
- ❻ L / R AF Input Gain Setting Buttons
- ❼ OLED Screen
- ❽ ACT: ACT Sync Button
- ❾ CONTROL: Parameter Setting Rotary Control Knob
- ❿ ANTENNA: TNC Antenna Connector
- ⓫ Dante: Dante Interface Connector
- ⓬ REMOTE: RJ-11 Network Interface Connector
- ⓭ LOOP OUT: Left / Right 6.3 Ø TRS Balanced Audio Output Jack
- ⓮ Left CH1 / Right CH2 XLR COMBO Audio Input Jack
- ⓯ DC IN: 12~15V DC Input Jack
- ⓰ Power Cord Hole

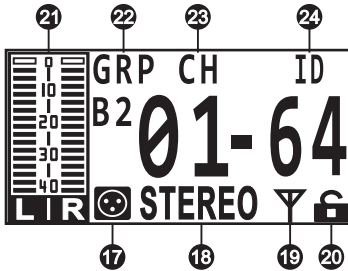

- ⓱ Audio Source Input Interface Icon: XLR or Dante
- ⓲ Audio Input Mode Type: Stereo or Mono
- ⓳ RF Signal Output: ON/OFF
- ⓴ Lock: Panel Locked Icon
- ⓵ L R: Left / Right Channel Audio Input Level Meter
- ⓶ GPR: Group Setting
- ⓷ CH: Channel Setting
- ⓸ ID: ID Code Setting

II. Operating Instructions

1. Antenna Installation:

- (A) Rear Antenna Installation: Attach supplied antenna to the antenna connector ⑩. Ensure both the antenna and the transmitter have the same frequency band for optimal transmitting efficiency.

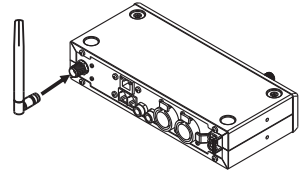

- (B) Install an optional FB-71 rear-to-front rackmount kit with cable. Attach supplied antenna to the front for improved optimal transmitting efficiency.

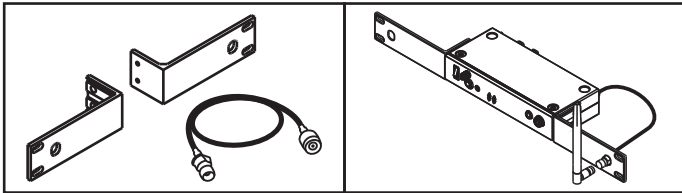

- (C) External Antenna Installation: Install optional MIPRO AT-58 antennas & MS-90 wall-mount kit or microphone stand with specific coaxial cable for improved performance. Ensure antennas are installed and positioned higher than the crowds and away from obstructions.

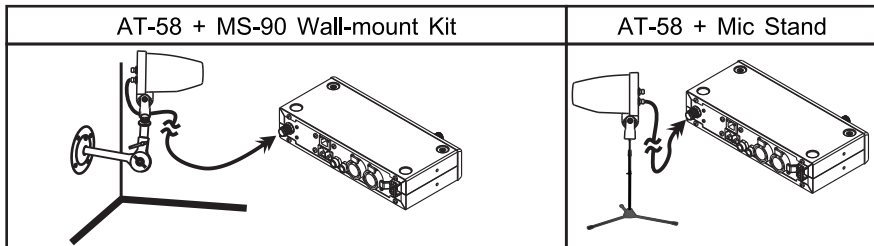

2. Power:

Connect the supplied 12~15VDC / 1A power supply & cable to the DC Input Jack ⑮. Get the cable through the cable hole to prevent accidental disconnection.

3. Power On:

Press the Power Button ① to the ON position. The OLED screen backlight lightens and displays various parameters.

4. Analog Audio Input and Output Connection:

In stereo mode, the stereo input signals with XLR plugs or the mixed mono signal with a 6.3 Ø phone plug by plugging into AF IN XLR Combo ⑭. The LOOP OUT ⑬ L and R output sockets are possible to transmit the audio signals from one transmitter daisy chaining the signals to other transmitters in balanced transmission mode.

5. Input Signals Level Indicator Setting

If the audio input signal is too low, it will result in a high noise floor and worse sound quality; if the audio input signal is too high, it will result in distortion.

Recommended setting methods as below:

- (A) Press the L/R-LEVEL Buttons **6** to set the LEVEL Meter to 0. Activate the source audio output and set the output level to the maximum.
- (B) Watch the color of the L/R Input Quality Indicator **5** and adjust the proper gain by the L/R-LEVEL Buttons **6** until the green indicator (OK) lights on.
- (C) Orange indicator (LOW) indicates the audio input signal or gain is set too low.
- (D) Red indicator (PEK) indicates the audio input signal or gain is set too high.
- (E) When the audio input signal continues to be too high, the screen will display "CLIP !" warning message to denote the sound distortion. It is necessary to check if the input signal level is set too high to avoid distortion.
- (F) During the setting process, plug the headphone into the monitor jack on the transmitter, and watch the color of OLED indicators to adjust the proper input level, and then turn on the receiver to monitor the sound.

6. Headphone Monitoring

- (A) Insert a 6.3 Ø or 3.5 Ø headphone into the Headphone Jacks **3** **4** , and adjust Volume Control **2** to the adequate volume.
- (B)  Warning: Permanent noise-induced hearing damage or loss may occur on prolonged exposure to loud sounds wearing earphones or headphones.
- (C) Minimize the volume level before the headphone is inserted.

7. Rack-mount Two units Side-by-side (optional accessories are required)

- (A) Remove top and bottom screws, insert top and bottom plates to joint two transmitters. Fasten screws.

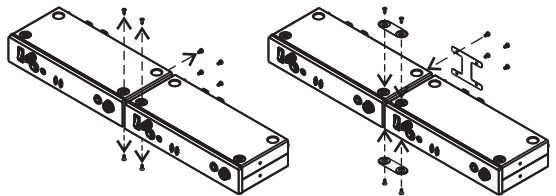

- (B) Rack-mount with the rack-mount kit (optional accessory).

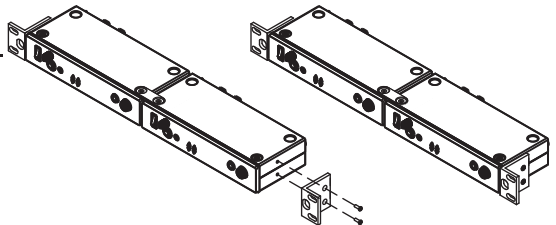

III. OLED Display & Operating Instructions

1. Rotary Control Knob: Menu Settings

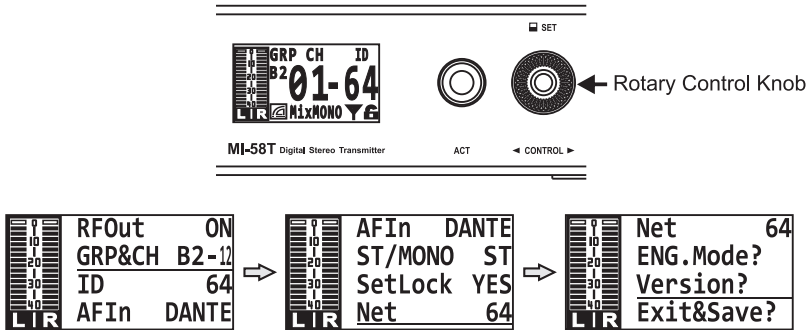

- (A) Press Rotary Control Knob to access Home Screen.
 (B) Turn right or left to access specific menus. Press to set the parameter.
 Turn to Exit & Save ? and press to save the setting and return to Home Screen.

2. RF OUT:

RF signal ON or OFF.

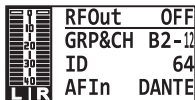

3. GRP&CH:

GROUP (A, B1, B2), CH (1~12).

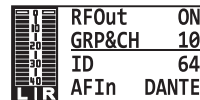

4. ID Code:

1~64 & **P** pairing mode. A total of 64 different IDs (01-64) can be selected for each channel. A proprietary 65th Pairing Mode (**P**) can be selected for 1-to-1 transmitting, and preventing audio signals received from other receivers.

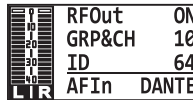

5. AF IN:

Analog XLR or digital Dante.

Caution: In Dante mode, LEVEL buttons **6** are not functional. Do gain adjustment from the source of digital audio.

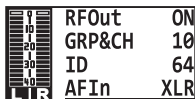

6. ST/MONO:

ST (Stereo) or MONO (L/R Mixed).



7. Set Lock:

YES (Lock) or NO (Unlock).

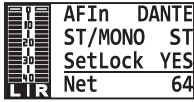

8. Net:

1~64, ACT BUS interface for address setting.



9. ENG. Mode (Engineer Mode): In this mode, you can load the settings of the other MI-58R receivers by one MI-58T.

- (A) Caution 1: All parameters should load from the receiver to the transmitter, set the names and order then send back to a designated receiver is operated and monitored by professional sound engineer.
- (B) Caution 2: Load or Send actions should be completed by ACT. Ensure to bring the ACT sync window of the transmitter close to the receiver and then press the rotary knob, the screen displays "ACT..." to denote synchronization. Wait until "ACT..." disappears, and the data transmission is completed.

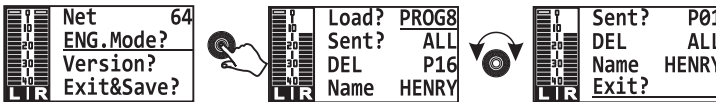

- (1) Load?: Select one (PROG1~PROG16) or Auto.

Note: This function only works when there are preset programs already.

- (2) Sent?: Send back to the receiver. Select one (1~16) or All.

Note: This function works only when the receiver and transmitter have synced all data.

- (3) DEL: Delete the data. Select one (P01~P16) or All.

- (4) Name: Rename the program (preset names in Auto mode: P01~P16)

- (5) Exit ? : Exit ENG MODE.

10. Version ?:

Displays the current firmware version.

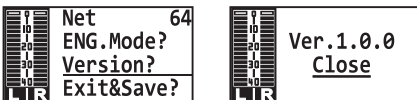

11. Exit & Save?:

Save changes and exit to Home screen.



12. ACT sync operation:

- (A) Press the ACT sync button on the panel of the transmitter to activate the synchronization. The screen displays “ACT....” Align the ACT sync windows of both transmitter and receiver within 30 cm. The word “ACT...” disappears during successful sync, and then it returns to the Home screen.
- (B) “FAIL” appears during a failed sync. Repeat the procedure.

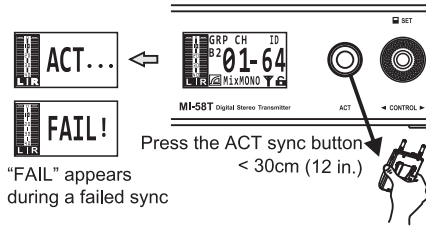

IV. Network Connection

1. New network interface. Connect to the MES-100 (optional) for remotely control by web browsers, such as Chrome/Firefox/Safari/IE.

Note: Please refer to the MES-100 firmware version supported.

2. ACT-BUS Wiring Instructions:

- (A) Use one RJ-11 cable to connect TX1 and TX2, another RJ-11 to connect TX2 and TX3, and so on.
- (B) Use an RJ-11 cable to connect TX1 to MES-100.
- (C) Up to 64 transmitters can be linked.
- (D) The recommended cable length of RJ-11 should not exceed 100 m to ensure high-speed transmission quality.

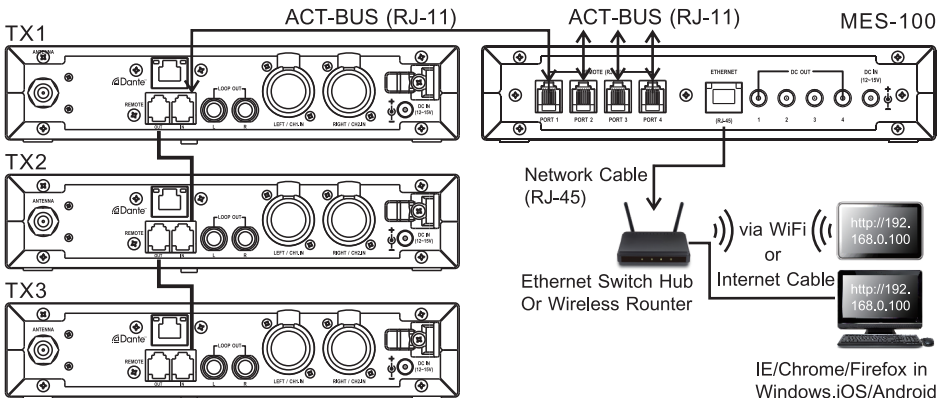

V. MI-58TD Dante Network Operation (optional)

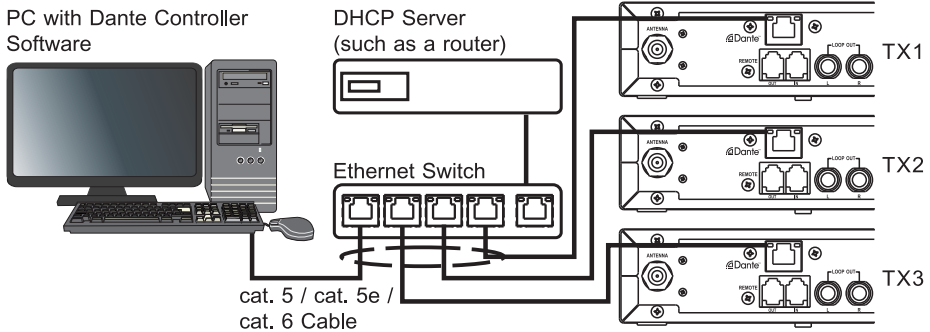

1. Dante Wiring:
 - (A) Connect MI-58TD via Dante port by Cat.5, Cat.5e, or Cat.6 cable with Ethernet switch to construct the Dante network.
 - (B) Note: The Ethernet switch needs to be connected with a DHCP server such as a router to provide the DHCP function.
2. Software Operating Instructions: Install Dante Controller software on PC to perform audio stream routing and monitoring.
3. The user guide of Dante Controller can be downloaded at the website of Audinate: <https://www.audinate.com/products/software/dante-controller>

VI. Cautions & Recommendations

1. Do not use the same frequency bands when mixing MIPRO IEM and MIPRO wireless microphone systems to avoid potential interferences.
2. Do use 50Ω coaxial cable to connect the transmitter to the external antenna. RG-58 or 3D cable should not exceed 2 meters. Recommend to use 5D-FB or 8D-FB cable for an even longer length to decrease the cable loss of 5 GHz transmission.
3. If possible, maintain line-of-sight between transmitter and receivers for optimal reception quality during outdoor or indoor performances. Indoor reception quality tends to degrade due to obstacles and objects absorbing radio waves making the reception distance shorter compared with outdoor performances.
4. The power supply voltage should not be less than 12V and not higher than 15V. Ensure at least 1A or more output current. Insufficient voltage causes operating instability or malfunction; exceeding voltage causes reduced product life cycle and possible short or damaging circuits.
5. MI-58T/MI-58TD stationary transmitter should pair with the MI-58R bodypack receiver.

VII. Notes

1. Refer to the actual product in the event of product discrepancy.
2. Carrier frequency range, RF power and maximum deviation range comply with the regulations of different countries.

MIPRO[®]
MICROPHONE PROFESSIONALS

MIPRO Electronics Co., Ltd

Headquarters: No. 814, Beigang Rd., Chiayi City 600079, Taiwan
Tel : +886.5.238.0809
www.mipro.com.tw

Fax : +886.5.238.0803
mipro@mipro.com.tw

All rights reserved. YM 021/07

Do not copy or forward without prior approvals of MIPRO.
Specifications and design subject to change without notice.



2 CE657B