

 **apart**

MASK2
Instruction manual

MASK2 manual



Introduction

Please read this manual carefully before using the product. This will give you the necessary product and installation instructions to assure a seamless installation and non-compromised overall sound quality.

Thank you for purchasing loudspeakers of the MASK series.

MASK2: Smaller, cuter, easier, ... but don't be fooled by his tiny appearance...

The Apart MASK2 speaker has successfully combined the typical MASK look and the small size, but without losing the MASK sound quality. MASK2 has been designed to fit into any interior and suits many different situations. Popular applications are multiroom audio systems, meeting rooms, shops, you name it.

Like all the MASK series, it has been designed for the true music lover, with the installer in mind.

Safety instructions

- Keep this manual for future reference.
- Take care of your speaker wires, they should be free of damage. Damaged speaker wires may result in poor sound quality and can damage amplifiers.
- No mains power should be connected to the speakers, doing so will damage the speaker.
- This speaker should only be serviced by qualified personnel. If not, warranty might be void.
- Use cables of the right gauge, certainly for long runs.
- Use cables with clear color indication and maintain polarity throughout the whole system.
- Avoid loud feedback for this is a main speaker killer.
- Clean only with dry cloth.
- Do not operate near heaters or place it on other apparatus which produce a lot of heat.
- Only use accessories specified by the manufacturer.
- Make sure the mounting surface can easily support the speaker's weight.
- Use only industry-accepted rigging tools and methods.
- Use sufficient loudspeakers and avoid death spots.
- Being exposed to loud levels over a long time can cause severe hearing loss.

- Don't forget to consult the local law directions regarding producing sound in public places.
- Please check the unit's condition after unpacking. If the outside of the carton box has been damaged, inform your shipper immediately.

Features and benefits

- timeless design
- small, cute and easy to install
- 50 W RMS (using a 150 Hz / 12 dB / octave highpass filter)
- perfect match with Apart SUBLIME subwoofer
- 2.5" paper cone woofer
- inventive turn/tilt bracket

Mounting the speaker

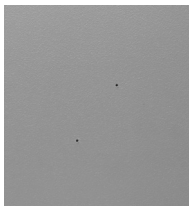

1. It is recommended to point the center of the speaker to the center of the dedicated listening area. Before mounting the bracket on the wall or ceiling, test-fit the speaker-bracket combination to see if you can reach the desired mounting angle. Determine the position of the mounting holes using the bracket as a template and drill the holes.

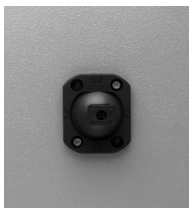

2. Mount the bracket to the surface. The mounting materials for solid brick walls are included. For other materials you may need other hardware.



3. Once all screws have been securely tightened, place the included screw covers in place.

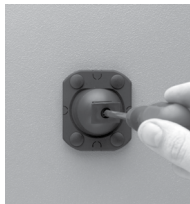

- The angle can be determined by the position of the bracket base and the position of the H-hook on the half-sphere ball. The factory default force setting of this central screw is adjusted for moving the H-hook over the semi-sphere with or without the cabinet being over the hook. You can fasten or loosen the central screw to influence the turning force of the H-hook.

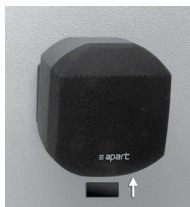

- Now slide out the rubber security piece from the back of the speaker, slide the speaker on the H-hook of the mounting bracket. Slide the rubber part back in place to lock and secure the cabinet. Plug the euroblock connector into the speaker.



- Consider to hide the speaker cable by guiding it through one of the 4 pre-cut cable entries on the sides of the bracket base.

Note: With the MASK2CMT-W and the MASK2CMT-BL APART provides an easy extension to the MASK2 bracket to ceiling mount the MASK2 speakers.



Connecting the speaker

- Remove the euroblock connector from the speaker and connect the speaker wire to the euroblock connector. Mind the polarity marked on the back of the speaker: + is positive, - is negative. Most speaker wires have a color code. Respect the color code starting at your amplifier up to your speakers.
- For distances up to 20 meters, you can use 0.75 mm² speaker wire without any loss of performance. For longer distances, use thicker wire.

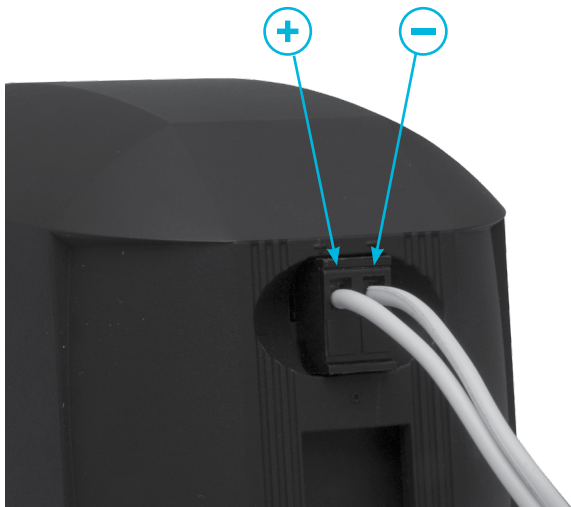

8Ω technology



- dynamic high power
- stereo Hi-Fi quality
- same volume in all zones
- max 4 cabinets on a stereo Hi-Fi amplifier

*Note: Do not attempt to use these small speakers as full range speakers, they are not designed to reproduce bass frequencies. We strongly recommend the use of our matching subwoofers as our **SUBLIME** or matching high pass filter systems.*

Note: the overload protection system is incorporated in subwoofers and amplifiers, NOT in the MASK2 speaker itself.

Connect the left output from the power amplifier to the left input of the SUBLIME subwoofer.

Connect the right output from the power amplifier to the right input of the SUBLIME subwoofer.

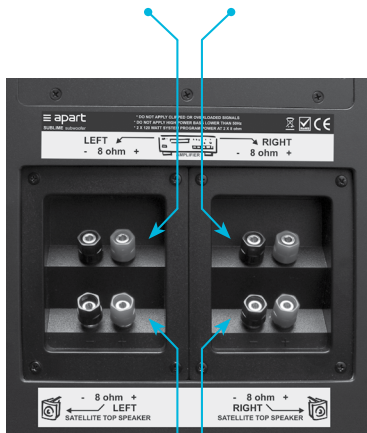

Connect the left satellite speaker (MASK2) to the left output of the SUBLIME subwoofer.

Connect the right satellite speaker (MASK2) to the right output of the SUBLIME subwoofer.

Technical drawings

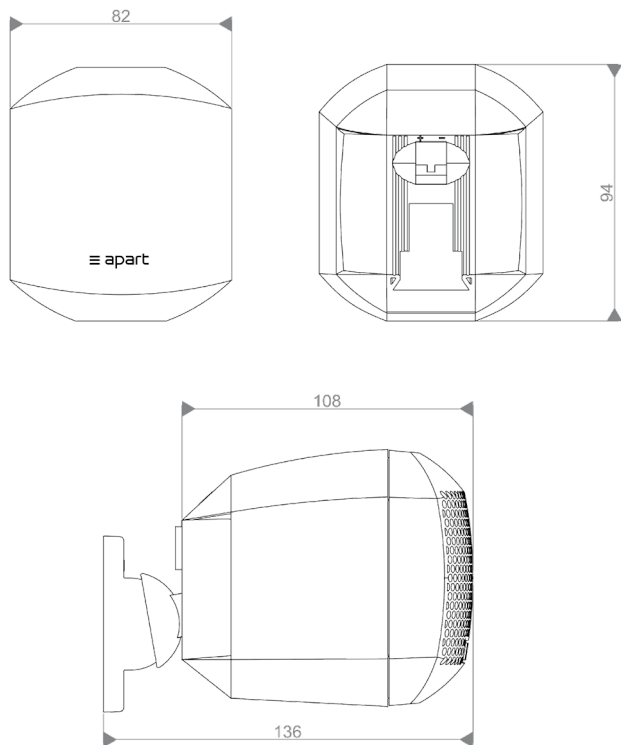

Polar diagram

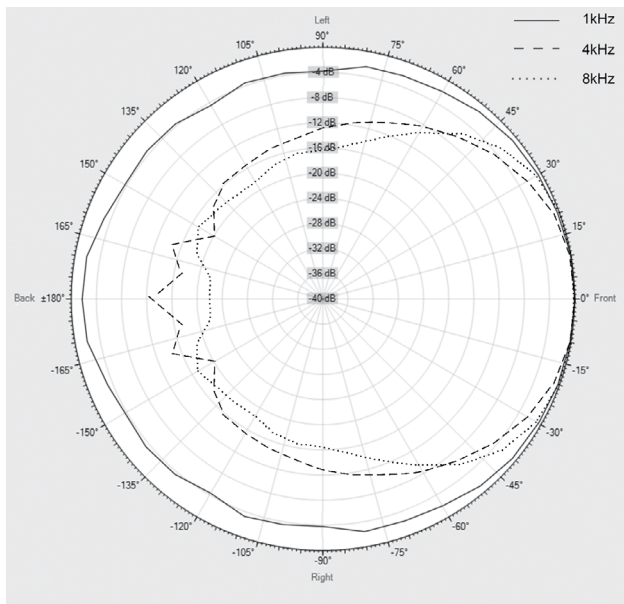

Technical specifications

Woofer size	Full range 2.5" speaker
Loudspeaker system	Full range
Nominal impedance	8 Ω
Frequency range	120 – 20 kHz (without subwoofer)
Program power	50 watts
SPL at 1 W / 1 m	87 dB
Max SPL at 1 m	98 dB
Distance from wall	Approx 30 mm using included brackets
IP rating	60
Main construction material	ABS plastic
Grill main material	Cloth
Shipping weight	1.3 kg (1 speaker pair with accessories)
Net weight	0.44 kg (1 speaker)
Dimensions (h x w x d)	94 x 82 x 108 mm (without mounting bracket)
Shipping dimensions (h x w x d)	130 x 146 x 310 mm
Colour	Black / white
Accessories (supplied)	Mounting bracket, mounting hardware, screws, screw covers and white gloves (MASK2-W).

developed
by
Audioprof nv
Industriepark Brechtsebaan 8 bus 1
2900 Schoten - Belgium

Company names, product names and trademarks are property of their respective owners.

Apart-Audio specifications are subject to change without notice.

