

KC-400



KC-600



KC-990



Main Features

KC-400, KC-600 and KC-990 are keyboard amps designed for high sound quality, and are suitable for a variety of sources such as keyboards and sound modules.

- They feature a two-way design with a speaker(s) and tweeter.

	Speaker	Output
KC-400	30 cm + horn tweeter	150 W
KC-600	38 cm + horn tweeter	200 W
KC-990	30 cm x 2 + horn tweeter x2	320 W (160 W + 160 W)

- The input section is equipped with a mixer. CH1 additionally provides an XLR connector that supports mic input. On the KC-400 and KC-600, CH4 is equipped with a monitor function that's convenient for stage monitoring.
- SUB OUT is provided on the KC-400 and KC-600. If a powered subwoofer is connected to this jack, the low-frequency range can be reproduced even more powerfully.
- Two types of AUX IN jack (RCA phono and stereo mini-jack) are provided for easily connecting an audio player or other source. The KC-990 is additionally equipped with phone-type jacks as well.
- The KC-990 features a completely stereo design.
- The three-band equalizer is convenient for adjusting the character of the sound.
- The headphone jack is convenient for monitoring at night, etc.



USING THE UNIT SAFELY

Before using this unit, carefully read “IMPORTANT SAFETY INSTRUCTIONS” (inside front cover), “USING THE UNIT SAFELY” (p. 2), and “IMPORTANT NOTES” (p. 3). After reading, keep the document(s) where it will be available for immediate reference.







Copyright © 2017 ROLAND CORPORATION

INSTRUCTIONS FOR THE PREVENTION OF FIRE, ELECTRIC SHOCK, OR INJURY TO PERSONS

About  WARNING and  CAUTION Notices

 WARNING	Used for instructions intended to alert the user to the risk of death or severe injury should the unit be used improperly.
 CAUTION	Used for instructions intended to alert the user to the risk of injury or material damage should the unit be used improperly. * Material damage refers to damage or other adverse effects caused with respect to the home and all its furnishings, as well to domestic animals or pets.

About the Symbols

	The  symbol alerts the user to important instructions or warnings. The specific meaning of the symbol is determined by the design contained within the triangle. In the case of the symbol at left, it is used for general cautions, warnings, or alerts to danger.
	The  symbol alerts the user to items that must never be carried out (are forbidden). The specific thing that must not be done is indicated by the design contained within the circle. In the case of the symbol at left, it means that the unit must never be disassembled.
	The  symbol alerts the user to things that must be carried out. The specific thing that must be done is indicated by the design contained within the circle. In the case of the symbol at left, it means that the power-cord plug must be unplugged from the outlet.

ALWAYS OBSERVE THE FOLLOWING

WARNING

Make sure that the power cord is grounded

Connect mains plug of this model to a mains socket outlet with a protective earthing connection.



To completely turn off power to the unit, pull out the plug from the outlet

Even with the power switch turned off, this unit is not completely separated from its main source of power. When the power needs to be completely turned off, turn off the power switch on the unit, then pull out the plug from the outlet. For this reason, the outlet into which you choose to connect the power cord's plug should be one that is within easy reach and readily accessible.



Secure a sufficient amount of space at the setup location

Since this unit normally emits a slight amount of heat, make sure to secure sufficient space around it, as shown below.

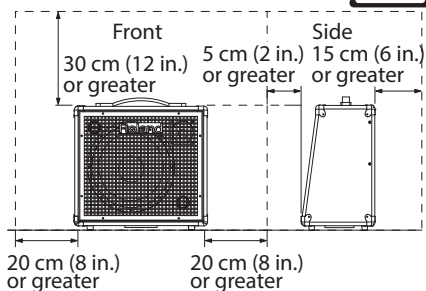

Do not disassemble or modify by yourself

Do not carry out anything unless you are instructed to do so in the owner's manual. Otherwise, you risk causing malfunction.



Do not repair or replace parts by yourself

Refer all servicing to your retailer, the nearest Roland Service Center, or an authorized Roland distributor, as listed on the "Information."



WARNING

Do not use or store in the following types of locations

- Subject to temperature extremes (e.g., direct sunlight in an enclosed vehicle, near a heating duct, on top of heat-generating equipment); or are
- Damp (e.g., baths, washrooms, on wet floors); or are
- Exposed to steam or smoke; or are
- Subject to salt exposure; or are
- Exposed to rain; or are
- Dusty or sandy; or are
- Subject to high levels of vibration and shakiness; or are
- Placed in a poorly ventilated location.



Do not place in an unstable location

Otherwise, you risk injury as the result of the unit toppling over or dropping down.



Connect the power cord to an outlet of the correct voltage

The unit should be connected to a power supply only of the type described as marked on the rear side of unit.



Use only the supplied power cord

Use only the attached power cord. Also, the supplied power cord must not be used with any other device.



Do not bend the power cord or place heavy objects on it

Otherwise, fire or electric shock may result.



Avoid extended use at high volume

Use of the unit at high volume for extended periods of time may cause hearing loss. If you ever experience any hearing loss or ringing in the ears, you should immediately stop using the unit and consult a specialized physician.



WARNING

Do not allow foreign objects or liquids to enter unit; never place containers with liquid on unit

Do not place containers containing liquid (e.g., flower vases) on this product. Never allow foreign objects (e.g., flammable objects, coins, wires) or liquids (e.g., water or juice) to enter this product. Doing so may cause short circuits, faulty operation, or other malfunctions.



Turn off the unit if an abnormality or malfunction occurs

Immediately turn the unit off, remove the power cord from the outlet, and request servicing by your retailer, the nearest Roland Service Center, or an authorized Roland distributor, as listed on the "Information" when:



- The power cord has been damaged; or
- If smoke or unusual odor occurs; or
- Objects have fallen into, or liquid has been spilled onto the unit; or
- The unit has been exposed to rain (or otherwise has become wet); or
- The unit does not appear to operate normally or exhibits a marked change in performance.

Be cautious to protect children from injury

Always make sure that an adult is on hand to provide supervision and guidance when using the unit in places where children are present, or when a child will be using the unit.



Do not drop or subject to strong impact

Otherwise, you risk causing damage or malfunction.



Do not share an outlet with an unreasonable number of other devices

Otherwise, you risk overheating or fire.



Do not use overseas

Before using the unit in overseas, consult with your retailer, the nearest Roland Service Center, or an authorized Roland distributor, as listed on the "Information."



Don't block ventilation openings

Don't allow the unit's ventilation openings to be blocked by a newspaper, tablecloth, curtains, or similar objects.



Don't place burning objects on the unit

Don't place any burning object (such as a candle) on the unit.



Be aware of weather conditions

Use the apparatus in moderate climates.



CAUTION

When disconnecting the power cord, grasp it by the plug

To prevent conductor damage, always grasp the power cord by its plug when disconnecting it.



Periodically clean the power plug

An accumulation of dust or foreign objects between the power plug and the power outlet can lead to fire or electric shock.



At regular intervals, be sure to pull out the power plug, and using a dry cloth, wipe away any dust or foreign objects that may have accumulated.

Disconnect the power plug whenever the unit will not be used for an extended period of time

Fire may result in the unlikely event that a breakdown occurs.



Route all power cords and cables in such a way as to prevent them from getting entangled

Injury could result if someone were to trip on a cable and cause the unit to fall or topple.



CAUTION

(KC-600 and KC-990 only) Remove all casters if mobility presents danger

In every situation where the unexpected movement of this unit could present a danger (such as when it's set up on a stage, or when it's being transported inside a vehicle), make sure to remove all the casters.



Avoid climbing on top of the unit, or placing heavy objects on it

Otherwise, you risk injury as the result of the unit toppling over or dropping down.



Never connect/disconnect a power plug if your hands are wet

Otherwise, you could receive an electric shock.



Disconnect all cords/cables before moving the unit

Before moving the unit, disconnect the power plug from the outlet, and pull out all cords from external devices.



CAUTION

Before cleaning the unit, disconnect the power plug from the outlet

If the power plug is not removed from the outlet, you risk receiving an electric shock.



Whenever there is a threat of lightning, disconnect the power plug from the outlet

If the power plug is not removed from the outlet, you risk causing malfunction or receiving an electric shock.



Do not remove the speaker grille and speaker

Do not remove the speaker grille and speaker by any means. Speaker is not user replaceable. Shock hazardous voltages and currents are present inside the enclosure.



English

日本語

Deutsch

Français

Italiano

Español

Português

Nederlands

IMPORTANT NOTES

Power Supply

- Do not connect this unit to same electrical outlet that is being used by an electrical appliance that is controlled by an inverter or a motor (such as a refrigerator, washing machine, microwave oven, or air conditioner). Depending on the way in which the electrical appliance is used, power supply noise may cause this unit to malfunction or may produce audible noise. If it is not practical to use a separate electrical outlet, connect a power supply noise filter between this unit and the electrical outlet.

Placement

- Using the unit near power amplifiers (or other equipment containing large power transformers) may induce hum. To alleviate the problem, change the orientation of this unit; or move it farther away from the source of interference.
- This unit may interfere with radio and television reception. Do not use this unit in the vicinity of such receivers.
- Noise may be produced if wireless communications devices, such as cell phones, are operated in the vicinity of this unit. Such noise could occur when receiving or initiating a call, or while conversing. Should you experience such problems, you should relocate such wireless devices so they are at a greater distance from this unit, or switch them off.
- When moved from one location to another where the temperature and/or humidity is very different, water droplets (condensation) may form inside the unit. Damage or malfunction may result if you attempt to use the unit in this condition. Therefore, before using the unit, you must allow it to stand for several hours, until the condensation has completely evaporated.
- Depending on the material and temperature of the surface on which you place the unit, its rubber feet may discolor or mar the surface.

- Do not place containers or anything else containing liquid on top of this unit. Also, whenever any liquid has been spilled on the surface of this unit, be sure to promptly wipe it away using a soft, dry cloth.

Maintenance

- Never use benzine, thinners, alcohol or solvents of any kind, to avoid the possibility of discoloration and/or deformation.

Additional Precautions

- Use a reasonable amount of care when using the unit's buttons, sliders, or other controls; and when using its jacks and connectors. Rough handling can lead to malfunctions.
- When disconnecting all cables, grasp the connector itself—never pull on the cable. This way you will avoid causing shorts, or damage to the cable's internal elements.
- A small amount of heat will radiate from the unit during normal operation.
- To avoid disturbing others nearby, try to keep the unit's volume at reasonable levels.
- Do not use connection cables that contain a built-in resistor.

Intellectual Property Right

- Roland is either registered trademarks or trademarks of Roland Corporation in the United States and/or other countries.
- Company names and product names appearing in this document are registered trademarks or trademarks of their respective owners.

Panel Descriptions (KC-400/KC-600)

Top Panel

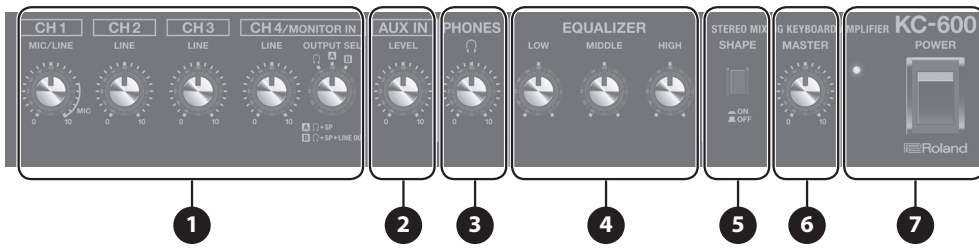

Rear Panel

* The illustration shows the KC-600. The KC-400 does not have LINE OUT: BALANCED jacks.

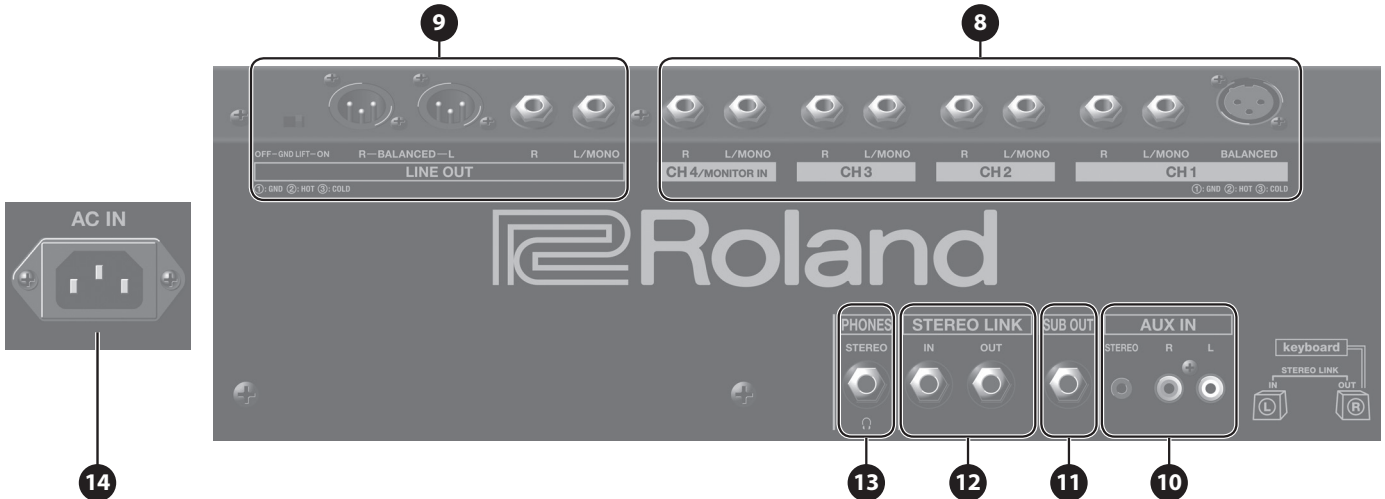

Top Panel

1 [CH1]–[CH4] knobs

Adjust the volume of the devices connected to CH1–CH4.

[OUTPUT SEL] knob

This knob lets you specify the output destination(s) of the signal that is input to CH4; you can choose from various combinations of the headphones, speaker, and line out. Choose from the following as appropriate for your situation.



Setting	Explanation
	Output only to headphones. The signal is not output to the internal speaker or to line out.
A +SP	Output to headphones and the internal speaker. The signal is not output to line out.
B +SP +LINE OUT	Output to all destinations: headphones, the internal speaker, and line out.

2 [AUX IN] knob

Adjusts the volume of the instrument that is connected to the AUX IN jacks.

3 [PHONES] knob

Adjusts the volume level of headphones output.

4 EQUALIZER

[LOW] knob

Adjusts the sound level of the low-frequency range.

[MIDDLE] knob

Adjusts the sound level of the middle-frequency range.

[HIGH] knob

Adjusts the sound level of the high-frequency range.

* The EQUALIZER knobs affect only the speaker output and the signal that is output from the SUB OUT jack.

5 [SHAPE] button

Switching on this button boosts the high-frequency and low-frequency ranges. This is a convenient way to compensate the tonal character or increase the impact when you're playing at a low volume.

* This applies only to the output of the internal speaker.

6 [MASTER] knob

Adjusts the overall volume.

This knob also simultaneously adjusts the volume that is output from the SUB OUT jack.

* The [MASTER] knob does not adjust the signal that is output from the LINE OUT jack.

7 [POWER] switch

Turns the power on/off. When the power is on, the indicator at the left of this switch is lit.

Rear Panel

8 CH1–CH4 input jacks

CH1: BALANCED jack, MIC/LINE jack

CH1 is equipped with a phone-type MIC/LINE jack and a balanced XLR-type BALANCED jack that is convenient for connecting a mic. This channel supports levels ranging from mic input level (-50 dBu) through line input level (-20 dBu) for sources such as a sound module.

* Pin assignment of CH1 BALANCED jack

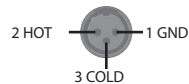

CH2–CH3: LINE jacks

Use these for connecting keyboards, sound modules, and other devices.

They accept line level input (-20 dBu).

CH4/MONITOR IN jack

Use this for connecting keyboards, sound modules, and other devices. This accepts line level input (-20 dBu).

You can use the [OUTPUT SEL] knob (p. 4) to specify the output destination.

9 LINE OUT jack

Connect this to your mixer or recorder.

The EQUALIZER knobs and the [MASTER] knob do not affect the volume or tone of the output from the LINE OUT jack.

* The KC-600 is equipped with XLR and phone jacks. These can both be used simultaneously.

* Pin assignment of LINE OUT: BALANCED jacks

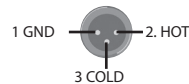

[GND LIFT] switch (KC-600 only)

Loop hum noise may occur when other external devices are connected to the unit. In such instances, you may be able to mitigate the problem by switching the position of the [GND LIFT] switch. The [GND LIFT] switch should be normally set to OFF.

10 AUX IN (STEREO, R/L) jacks

Here you can connect an audio player, electronic musical instrument, or similar audio source, and listen to it while you perform.

11 SUB OUT jack

You can connect this jack to a powered subwoofer or an external powered monitor. You can use the front panel knobs to adjust the volume and tone of the output from the SUB OUT jack.

12 STEREO LINK (IN, OUT) jacks

By using these jacks, you can combine two units into an even higher-output stereo system (p. 10).

13 PHONES jack

You can connect headphones here.

* The settings of the EQUALIZER knobs, the [SHAPE] button, and the [MASTER] knob do not affect the output from the PHONES jack.

14 AC IN jack

Connect the included power cord.

* Use only the power cord that was included with the unit.

Panel Descriptions (KC-990)

Top Panel

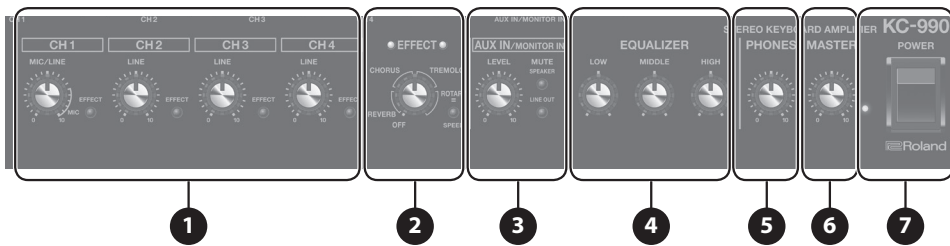

Rear Panel

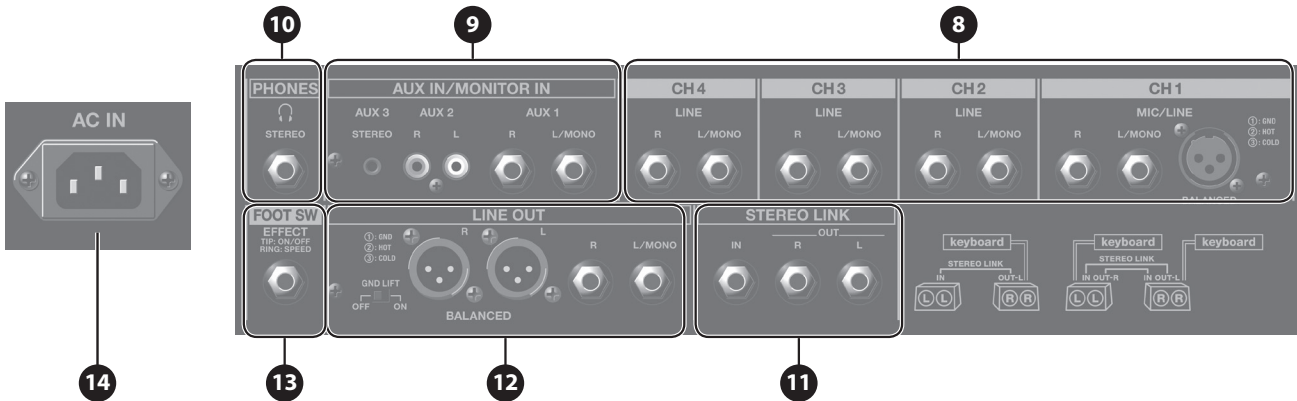

Top Panel

1 [CH1]–[CH4] knobs

Adjust the volume of the devices connected to CH1–CH4.

[EFFECT] buttons

You can switch the internal effect on/off for each channel. If the button is on, the effect selected by the [EFFECT] knob is applied.

2 [EFFECT] knob

The internal effect can be applied to the devices that are connected to CH1–CH4.

Depending on the position of the knob, it switches between four types of effects and adjusts the depth of the effect.

Effect	Explanation
REVERB	This effect adds reverberation to the sound.
CHORUS	An effect that adds a slightly modulated sound to the direct signal, creating beautiful spaciousness and depth.
TREMOLO	An effect that cyclically modulates the volume.
ROTARY	This produces an effect like the sound of a rotary speaker.

EFFECT indicator

The left and right indicators flash in alternately in time with the speed of the effect.

- * When REVERB or CHORUS is selected, both indicators light up.
- * When the effect is turned off using a footswitch, both indicators go out.

[SPEED] button (ROTARY)

Switches the speed of the ROTARY effect.

Press the button inward to make the modulation faster.

- * The speed of rotation changes smoothly when you switch it.
- * The [SPEED] button applies only to the ROTARY effect.

3 [AUX IN/MONITOR IN] knob

Adjusts the volume of the devices that are connected to the AUX IN/MONITOR IN jacks.

[MUTE] (SPEAKER/LINE OUT) buttons

Specify whether AUX IN is used as MONITOR IN. If each [MUTE] button is on, the sound of the device connected to the AUX IN/MONITOR IN jacks is no longer output from the internal speaker or from LINE OUT.

4 EQUALIZER

[LOW] knob

Adjusts the sound level of the low-frequency range.

[MIDDLE] knob

Adjusts the sound level of the middle-frequency range.

[HIGH] knob

Adjusts the sound level of the high-frequency range.

5 [PHONES] knob

Adjusts the volume level of headphones output.

6 [MASTER] knob

Adjusts the overall volume.

This knob also simultaneously adjusts the volume that is output from the SUB OUT jack.

- * The [MASTER] knob does not adjust the signal that is output from the LINE OUT jack.

7 [POWER] switch

Turns the power on/off. When the power is on, the indicator at the left of this switch is lit.

Rear Panel

8 CH1-CH4 input jacks

CH1: BALANCED jack, MIC/LINE jack

CH1 is equipped with a phone-type MIC/LINE jack and a balanced XLR-type BALANCED jack that is convenient for connecting a mic. This channel supports levels ranging from mic input level (-50 dBu) through line input level (-20 dBu) for sources such as a sound module.

* Pin assignment of CH1 BALANCED jack

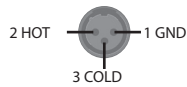

CH2-CH4: LINE jacks

Use these for connecting keyboards, sound modules, and other devices.

They accept line level input (-20 dBu).

9 AUX IN/MONITOR IN (STEREO, R/L) jacks

Here you can connect an audio player, electronic musical instrument, or similar audio source, and listen to it while you perform. When using the unit as a monitor for the performer, you can use these jacks to monitor a guide click from a rhythm machine etc. that is heard only by the performer.

10 PHONES jack

You can connect headphones here.

11 STEREO LINK (IN, OUT L/R) jacks

By using these jacks, you can combine two units into an even higher-output stereo system (p. 10).

12 LINE OUT jack

Connect this to your mixer or recorder.

The EQUALIZER knobs and the **[MASTER]** knob do not affect the volume or tone of the output from the LINE OUT jack.

* The KC-990 is equipped with XLR and phone jacks. These can both be used simultaneously.

* Pin assignment of LINE OUT: BALANCED jacks

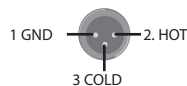

[GND LIFT] switch

Loop hum noise may occur when other external devices are connected to the unit. In such instances, you may be able to mitigate the problem by switching the position of the **[GND LIFT]** switch. The **[GND LIFT]** switch should be normally set to OFF.

13 FOOT SW jack

If a latch-type footswitch (sold separately: FS-5L, FS-6, FS-7) is connected here, you can use your foot to turn the internal effect on/off or adjust the speed of the rotary effect.

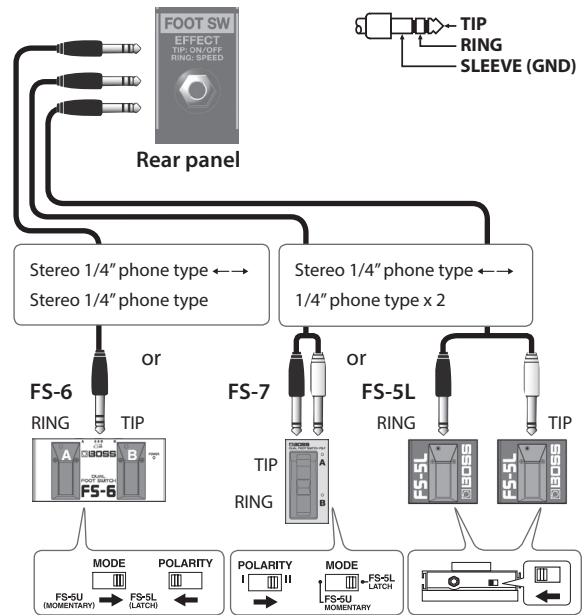

Switch		Explanation
TIP	EFFECT ON/OFF	Switches the internal effect on/off.
RING	SPEED (SLOW/FAST)	Switches the speed of the ROTARY effect (p. 6).

14 AC IN jack

Connect the included power cord.

* Use only the power cord that was included with the unit.

English

日本語

Deutsch

Français

Italiano

Español

Português

Nederlands

Connecting Your Equipment

Example connections KC-400/KC-600

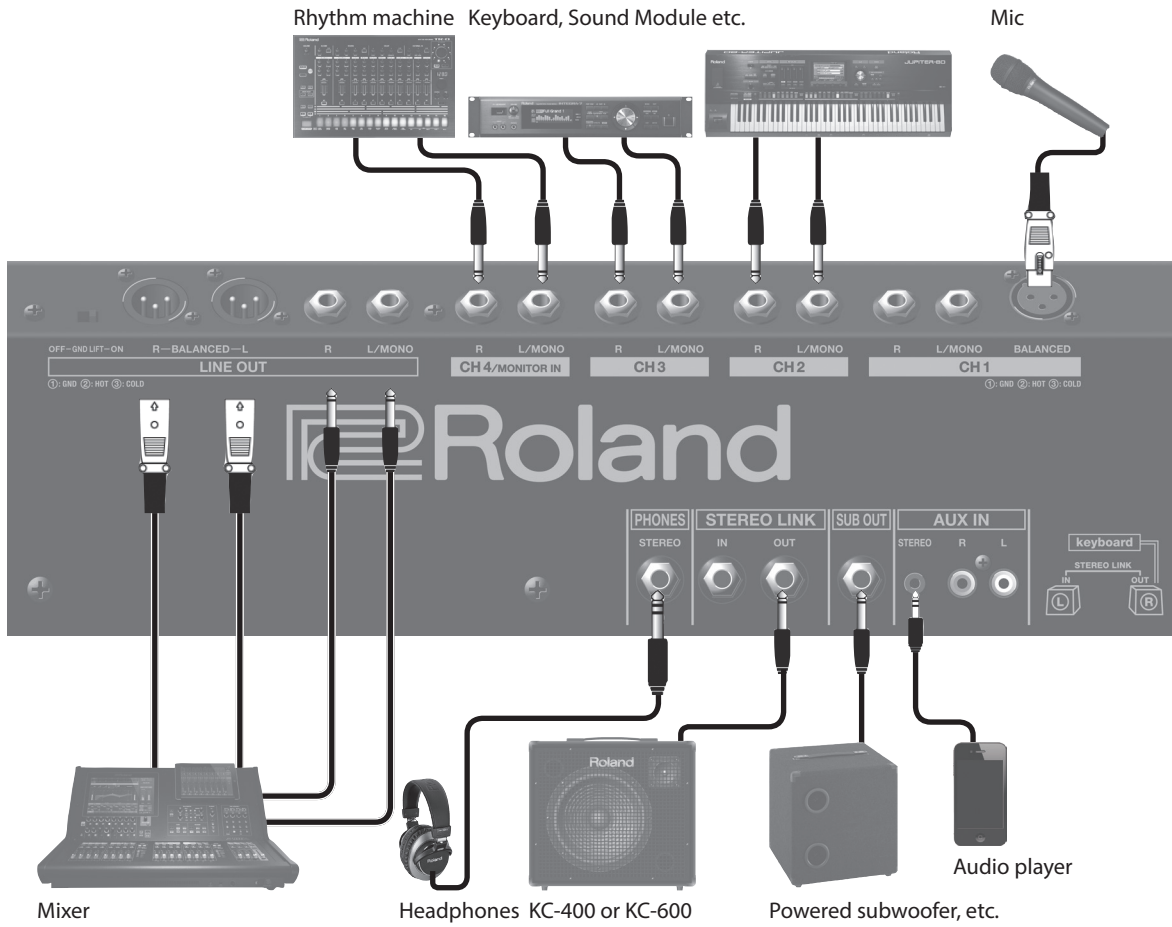

Example connections KC-990

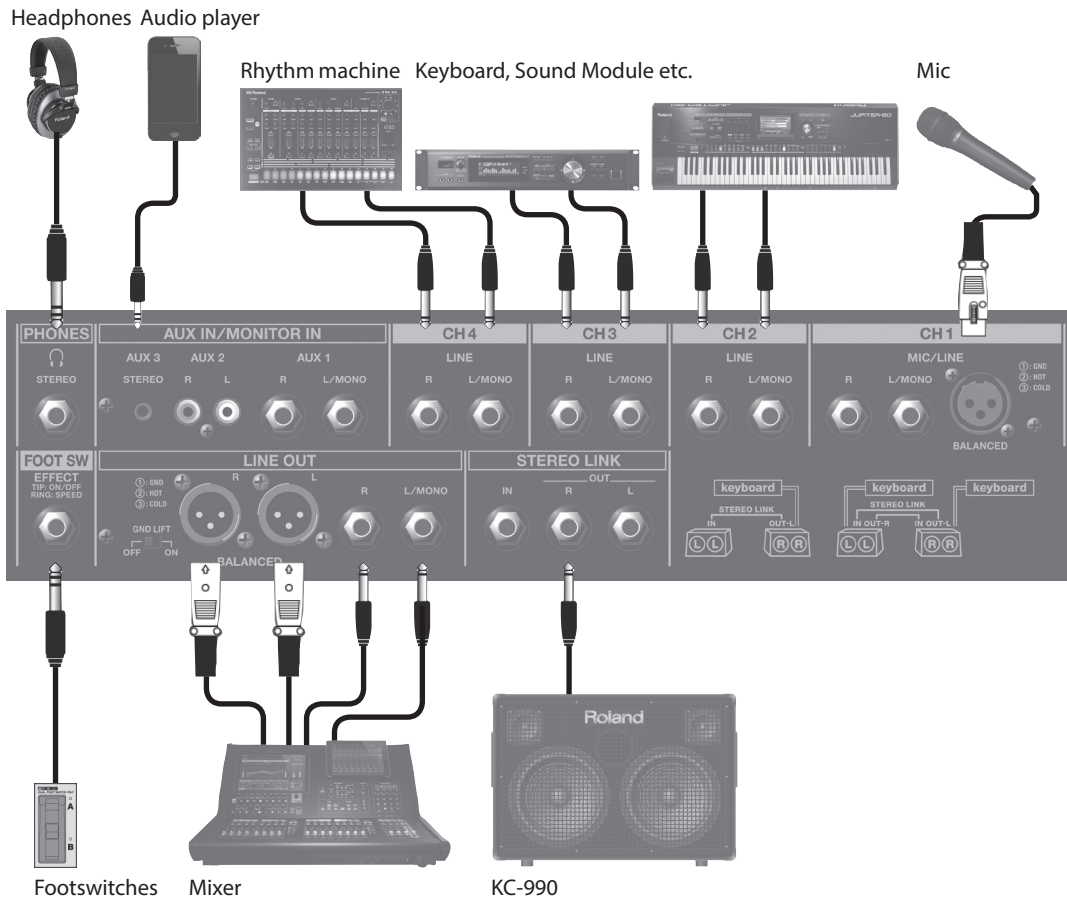

* To prevent malfunction and equipment failure, always turn down the volume, and turn off all the units before making any connections.

Turning the Power On/Off

* Once everything is properly connected, be sure to follow the procedure below to turn on their power. If you turn on equipment in the wrong order, you risk causing malfunction or equipment failure.

1. Make sure that this unit's [MASTER] knob and the volume of the devices connected to this unit are set to "0."
2. Turn on all the devices connected to the unit's input jacks (CH1-CH4, AUX IN, STEREO LINK IN).
3. Turn on the unit.
4. Turn on all the devices connected to the unit's output jacks (LINE OUT, SUB OUT, STEREO LINK OUT, PHONES).
5. Adjust the volume levels for the devices.

Before switching off the power, lower the volume on each of the devices in your system and then turn off the devices in the reverse order to which they were switched on.

- * Before turning the unit on/off, always be sure to turn the volume down. Even with the volume turned down, you might hear some sound when switching the unit on/off. However, this is normal and does not indicate a malfunction.
- * If you need to turn off the power completely, first turn off the unit, then unplug the power cord from the power outlet. Refer to "To completely turn off power to the unit, pull out the plug from the outlet" (p. 2).

Setting the Volume of Each Device

In order to get optimum sound from this unit when performing, set the volume as described below.

1. Use the [CH1]-[CH4] knobs to adjust the volume balance of the devices connected to CH1-CH4.
2. Use the [LOW] knob, [MIDDLE] knob, and [HIGH] knob to adjust the tone to your taste.
3. Use the [MASTER] knob to adjust the overall volume.

If the sound is distorted, adjust the [CH1]-[CH4] knobs and [MASTER] knob, or adjust the volume knob of the devices connected to the inputs (CH1-CH4, AUX IN).

Attaching Casters (KC-600/KC-990)

Casters are included with the KC-600 and KC-990 to allow easy transportation.

The casters are not fitted to the unit when shipped from the factory.

To fit or remove the casters, follow the diagram.

- * Be sure to set up and use these units in stable, level locations.
- * To prevent injury, make sure that at least two persons work together when carrying the units.
- * Be careful not to get your fingers or feet pinched.

Front side of the unit

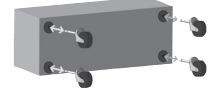

Caution when transporting the KC-990

Since the KC-990 is heavy (42 kg), it must be carried by two or more people when transporting the unit to avoid injury that might occur if the unit tips over or falls down.

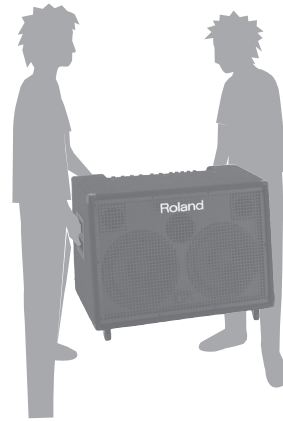

When carrying the unit, firmly grasp the left and right handles as shown in the illustration.



On flat surfaces, it is convenient to use the included casters.

Using Two Amps in Stereo (Stereo Link)

You can connect two amps of the same model and use them in stereo. This function is called “**stereo link**.”

KC-400/KC-600 Connection Example

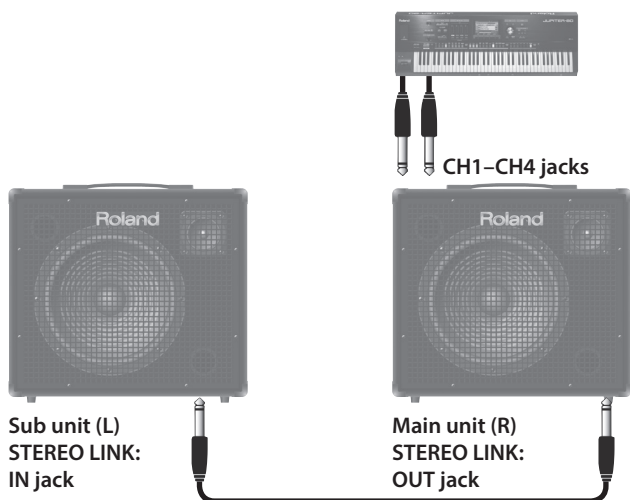

1. Connect all your input devices to the main unit.

* Don't connect anything to the sub unit other than to its STEREO LINK IN jack.

2. Use a phone cable to connect the main unit's OUT jack to the sub unit's IN jack.

The main unit is R, and the sub unit is L.

Sub unit

Main unit

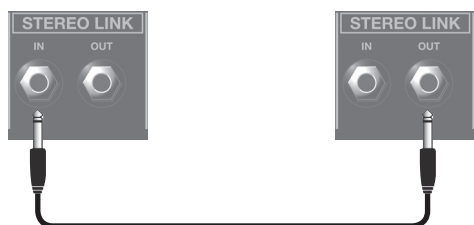

3. Power-on the main unit, and then power-on the sub unit.

For details, refer to “Turning the Power On/Off” (p. 9).

4. Adjust the volume of the devices that are connected to the main unit.

For details, refer to “Setting the Volume of Each Device” (p. 9)

5. Adjust the volume and tone of the main unit and sub unit, using the [VOLUME] knob and EQUALIZER knobs of each unit.

In general, use the same settings. Adjust each unit as necessary.

KC-990 Connection Example

There are two ways to make the KC-990's stereo link connection: basic connection using a single phone cable, or advanced connection using two phone cables.

If you use two phone cables to make the connection, all inputs of the two KC-990 units will be usable.

Basic Stereo Link

When connecting input devices to the KC-990 (L)

You can connect up to five input devices to CH1-CH4 and AUX IN.

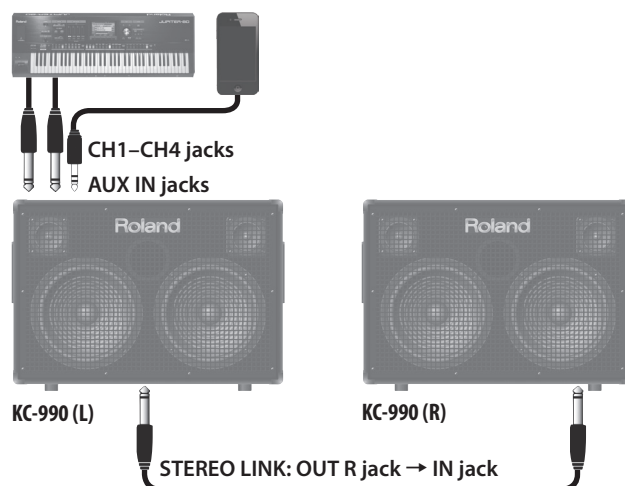

1. Connect all input devices to the KC-990 (L).

* Don't connect anything to the KC-990 (R) except to its STEREO LINK IN jack.

2. Use a phone cable to connect the KC-990 (L)'s LINK OUT R jack to the KC-990 (R)'s LINK IN jack.

KC-990 (L)

KC-990 (R)

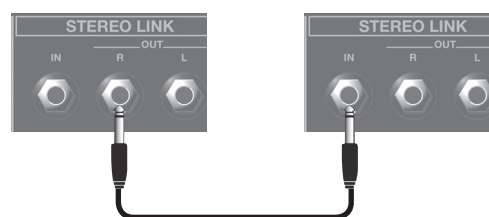

MEMO

If you want to connect input devices to the KC-990 (R), use a phone cable to connect the KC-990 (R)'s LINK OUT L jack to the KC-990 (R)'s LINK IN jack.

3. Power-on the KC-990 (L), and then power-on the KC-990 (R).

For details, refer to “Turning the Power On/Off” (p. 9).

4. Adjust the volume of the devices that are connected to the KC-990 (L).

For details, refer to “Setting the Volume of Each Device” (p. 9)

5. Adjust the volume and tone of the KC-990 (L) and KC-990 (R), using the [VOLUME] knob and EQUALIZER knobs of each unit.

In general, use the same settings. Adjust each unit as necessary.

Advanced Stereo Link

This lets you connect up to ten input devices using the CH1–CH4 and AUX IN jacks of the two KC-990 units.

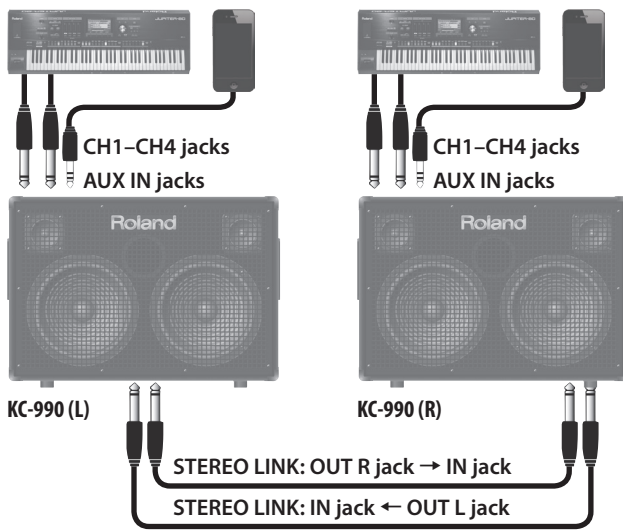

1. Connect the input devices to the KC-990 (L) and KC-990 (R).
2. Use a phone cable to connect the KC-990 (L)'s LINK OUT R jack to the KC-990 (R)'s LINK IN jack.
3. Use a phone cable to connect the KC-990 (R)'s LINK OUT L jack to the KC-990 (L)'s LINK IN jack.

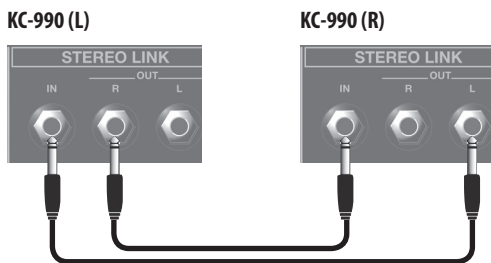

4. Power-on the KC-990 (L), and then power-on the KC-990 (R).

For details, refer to "Turning the Power On/Off" (p. 9).

5. Adjust the volume of the devices that are connected to the KC-990 (L) and KC-990 (R).

For details, refer to "Setting the Volume of Each Device" (p. 9)

6. Adjust the volume and tone of the KC-990 (L) and KC-990 (R), using the [VOLUME] knob and EQUALIZER knobs of each unit.

In general, use the same settings. Adjust each unit as necessary.

Block Diagram

KC-400/KC-600

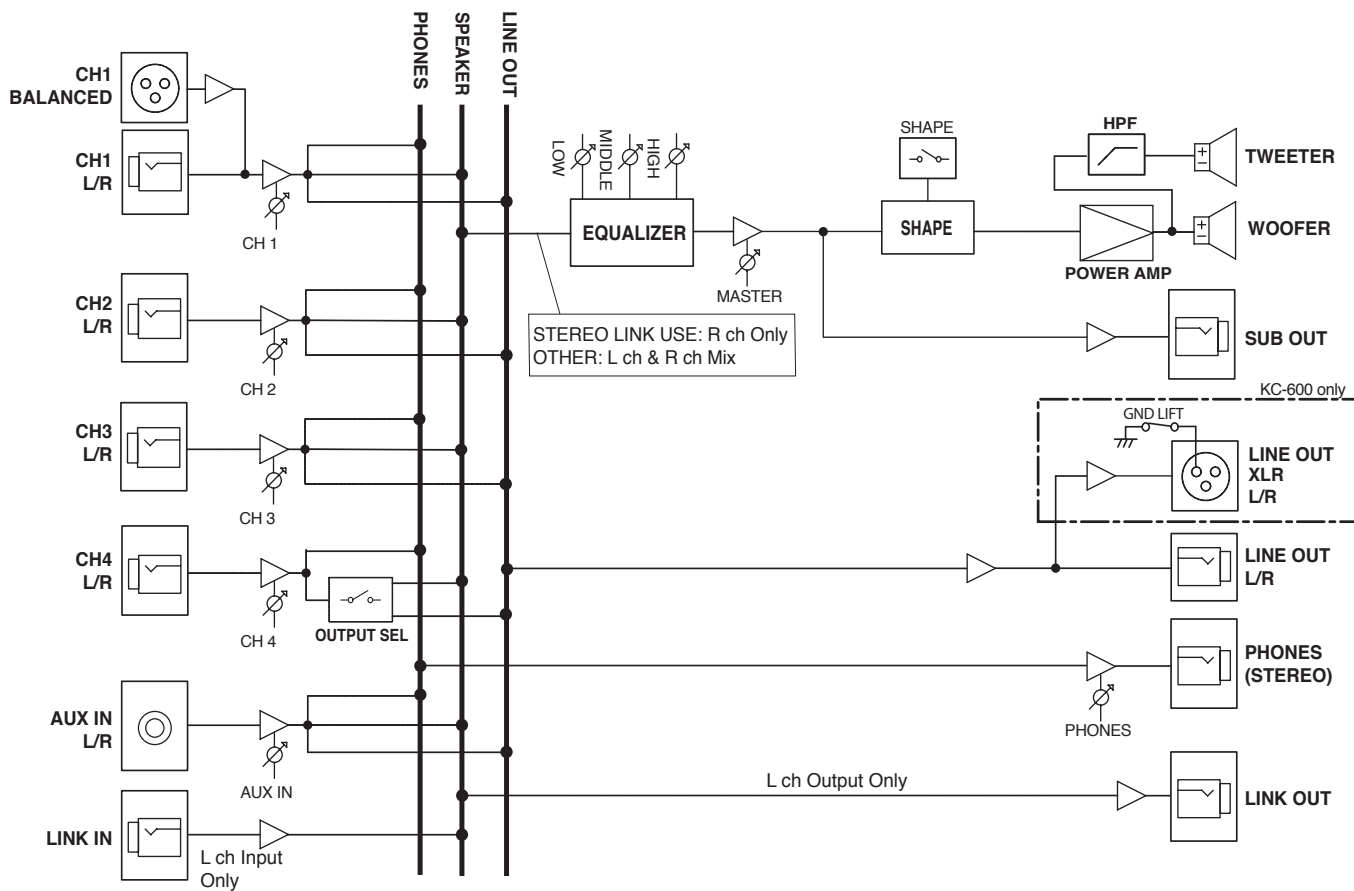

KC-990

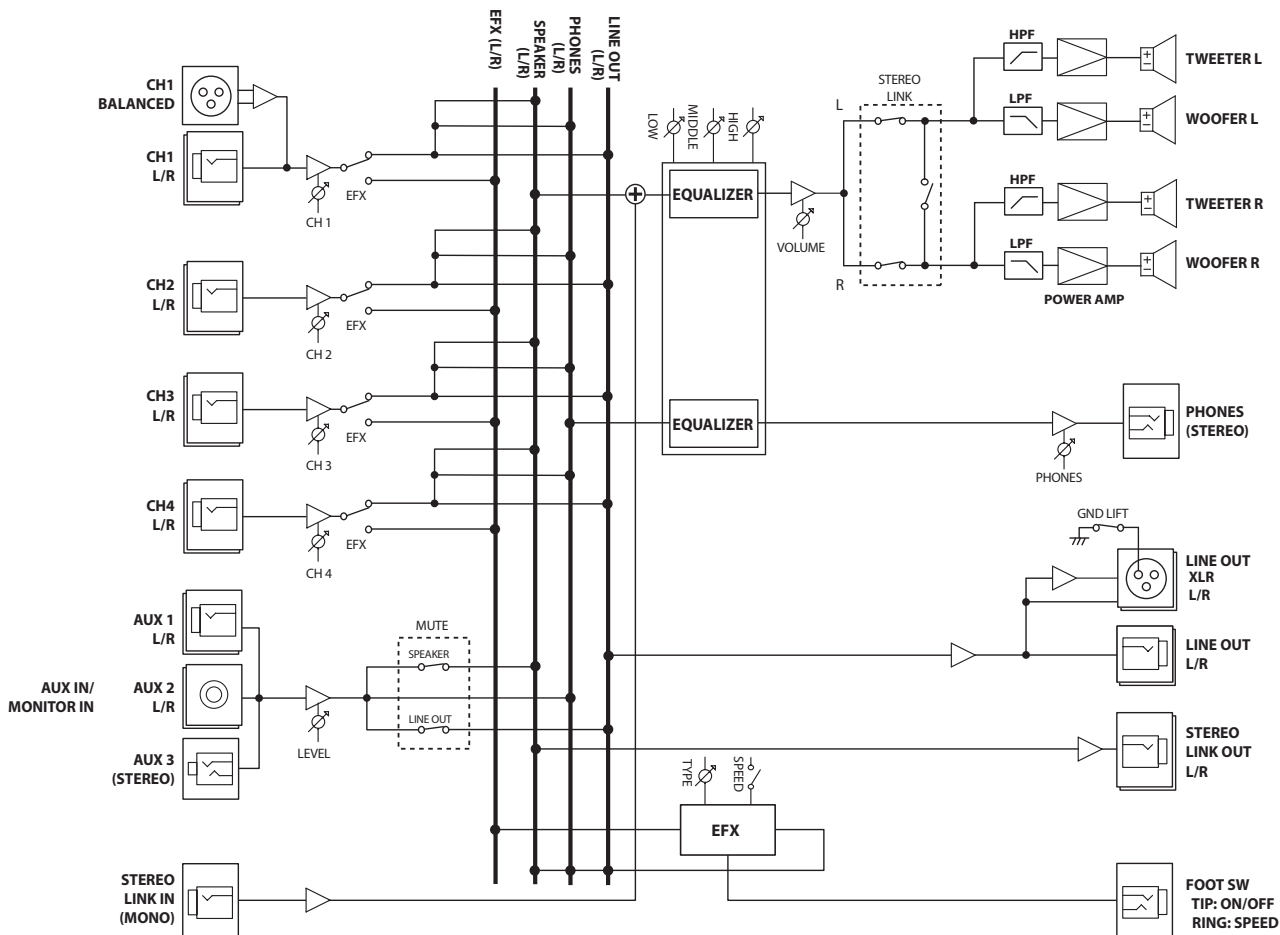

Main Specifications

Roland KC-400: STEREO MIXING KEYBOARD AMPLIFIER

Roland KC-600: STEREO MIXING KEYBOARD AMPLIFIER

Roland KC-990: STEREO MIXING KEYBOARD AMPLIFIER

	KC-400	KC-600	KC-990
Rated Power Output	150 W	200 W	320 W (160 W + 160 W)
Nominal Input Level (1 kHz)	CH1 (BALANCED, L/MONO, R): -50 -- -20 dBu CH2 (L/MONO, R): -20 dBu CH3 (L/MONO, R): -20 dBu CH4/MONITOR IN (L/MONO, R): -20 dBu AUX IN (L, R, STEREO): -10 dBu STEREO LINK (IN): 0 dBu		CH1 (BALANCED, L/MONO, R): -50 -- -20 dBu CH2 (L/MONO, R): -20 dBu CH3 (L/MONO, R): -20 dBu CH4 (L/MONO, R): -20 dBu AUX IN/MONITOR IN (AUX 1, AUX 2, AUX 3): -10 dBu STEREO LINK (IN): 0 dBu
Nominal Output Level (1 kHz)	LINE OUT (L/MONO, R): +4 dBu STEREO LINK (OUT): 0 dBu SUB OUT: +4 dBu	LINE OUT (L/MONO, R): +4 dBu LINE OUT (BALANCED L, R): +4 dBu STEREO LINK (OUT): 0 dBu SUB OUT: +4 dBu	LINE OUT (L/MONO, R): +4 dBu LINE OUT (BALANCED L, R): +4 dBu STEREO LINK (OUT): 0 dBu
Speakers	Full Range: 30 cm (12 inches) x 1 Horn Tweeter: x 1	Full Range: 38 cm (15 inches) x 1 Horn Tweeter: x 1	Full Range: 30 cm (12 inches) x 2 Horn Tweeter: x 2
Indicator	Power		
Connectors	CH1 (BALANCED) jack: XLR type CH1 (L/MONO, R) jacks: 1/4-inch phone type CH2 (L/MONO, R) jacks: 1/4-inch phone type CH3 (L/MONO, R) jacks: 1/4-inch phone type CH4/MONITOR IN (L/MONO, R) jacks: 1/4-inch phone type LINE OUT (L/MONO, R) jacks: 1/4-inch phone type AUX IN (L, R) jacks: RCA phono type AUX IN (STEREO) jacks: Stereo miniature phone type SUB OUT jack: 1/4-inch phone type STEREO LINK (IN, OUT) jacks: 1/4-inch phone type PHONES jack: Stereo 1/4-inch TRS phone type (mono signal output)	CH1 (BALANCED) jack: XLR type CH1 (L/MONO, R) jacks: 1/4-inch phone type CH2 (L/MONO, R) jacks: 1/4-inch phone type CH3 (L/MONO, R) jacks: 1/4-inch phone type CH4/MONITOR IN (L/MONO, R) jacks: 1/4-inch phone type LINE OUT (L/MONO, R) jacks: 1/4-inch phone type LINE OUT (BALANCED L, R) jacks: XLR type AUX IN (L, R) jacks: RCA phono type AUX IN (STEREO) jacks: Stereo miniature phone type SUB OUT jack: 1/4-inch phone type STEREO LINK (IN, OUT) jacks: 1/4-inch phone type PHONES jack: Stereo 1/4-inch TRS phone type (mono signal output)	CH1 (BALANCED) jack: XLR type CH1 (L/MONO, R) jacks: 1/4-inch phone type CH2 (L/MONO, R) jacks: 1/4-inch phone type CH3 (L/MONO, R) jacks: 1/4-inch phone type CH4 (L/MONO, R) jacks: 1/4-inch phone type AUX IN/MONITOR IN AUX 1 (L/MONO, R) jacks: 1/4-inch phone type AUX 2 (L, R) jacks: RCA phono type AUX 3 (STEREO) jacks: Stereo miniature phone type PHONES jack: Stereo 1/4-inch TRS phone type (mono signal output) STEREO LINK (IN, OUT L, OUT R) jacks: 1/4-inch phone type LINE OUT (L/MONO, R) jacks: 1/4-inch phone type LINE OUT (BALANCED L, R) jacks: XLR type FOOT SW jack: 1/4-inch TRS phone type
Power Consumption	40 W	50 W	98 W
Dimensions	490 (W) x 385 (D) x 470 (H) mm 19-5/16 (W) x 15-3/16 (D) x 18-9/16 (H) inches	590 (W) x 445 (D) x 590 (H) mm 23-1/4 (W) x 17-9/16 (D) x 23-1/4 (H) inches (including casters) 590 (W) x 445 (D) x 536 (H) mm 23-1/4 (W) x 17-9/16 (D) x 21-1/8 (H) inches (excluding casters)	759 (W) x 470 (D) x 585 (H) mm 29-15/16 (W) x 18-9/16 (D) x 23-1/16 (H) inches (including casters) 759 (W) x 470 (D) x 534 (H) mm 29-15/16 (W) x 18-9/16 (D) x 21-1/16 (H) inches (excluding casters)
Weight	22 kg 48 lbs 9 oz	29 kg 63 lbs 15 oz	42 kg 92 lbs 10 oz
Accessory	Owner's Manual	Owner's Manual Casters (x 4)	

* 0 dBu = 0.775 Vrms

* This document explains the specifications of the product at the time that the document was issued. For the latest information, refer to the Roland website.

English

日本語

Deutsch

Français

Italiano

Español

Português

Nederlands

 **Roland**