

auro

Active Subwoofer

Auro D1200
Auro D1500



OWNER'S MANUAL

SAMSON[®]

Important Safety Information



AVIS
RISQUE DE CHOC ÉLECTRONIQUE -
NE PAS OUVRIR

CAUTION: TO REDUCE THE RISK OF ELECTRIC SHOCK, DO NOT REMOVE COVER (OR BACK). NO USER-SERVICEABLE PARTS INSIDE. REFER SERVICING TO QUALIFIED SERVICE PERSONNEL.



This lightning flash with arrowhead symbol within an equilateral triangle is intended to alert the user to the presence of non-insulated "dangerous voltage" within the product's enclosure that may be of sufficient magnitude to constitute a risk of electric shock.



The exclamation point within an equilateral triangle is intended to alert the user to the presence of important operating and maintenance instructions in the literature accompanying the appliance.



If you want to dispose this product, do not mix it with general household waste. There is a separate collection system for used electronic products in accordance with legislation that requires proper treatment, recovery and recycling.

Private household in the 28 member states of the EU, in Switzerland and Norway may return their used electronic products free of charge to designated collection facilities or to a retailer (if you purchase a similar new one).

For Countries not mentioned above, please contact your local authorities for a correct method of disposal.

By doing so you will ensure that your disposed product undergoes the necessary treatment, recovery and recycling and thus prevent potential negative effects on the environment and human health.

1. Read these instructions.
2. Keep these instructions.
3. Heed all warnings.
4. Follow all instructions.
5. This apparatus shall not be exposed to dripping or splashing liquid and no object filled with liquid, such as a vase, should be placed on the apparatus.
6. Clean only with a dry cloth.
7. Do not block any of the ventilation openings. Install in accordance with the manufacturer's instructions.
8. Do not install near any heat sources such as radiators, heat registers, stoves, or other apparatuses (including amplifiers) that produce heat.
9. Only use attachments/accessories specified by the manufacturer.
10. Unplug this apparatus during lightning storms or when not in use for long periods of time.
11. Do not override the intended purpose of the polarized or grounding-type plug. A polarized plug has two blades, with one wider than the other. A grounding-type plug has two blades and a third grounding prong. The wide blade, or third prong, is provided for your safety. If the provided plug does not fit your outlet, consult an electrician to replace the obsolete outlet.
12. Protect the power cord from being walked on or pinched, particularly at the prongs, convenience receptacles, the point where they exit from the apparatus.
13. Use only with the cart stand, tripod bracket, or table specified by the manufacture, or sold with the apparatus. When a cart is used, utilize caution when moving the cart/apparatus combination to avoid injury from tip-over. 
14. Refer all servicing to qualified service personnel. Servicing is required if the apparatus has been damaged in any way, such as power-supply cord or plug breakage, damage due to liquid or objects falling onto the apparatus, exposure to rain or moisture, or if the apparatus does not operate normally, or has been dropped.
15. **POWER ON/OFF SWITCH:** For products with a power switch, the power switch DOES NOT break the connection from the mains.
16. **MAINS DISCONNECT:** The plug should remain readily operable. For rack-mount or installation where plug is not accessible, an all-pole mains switch with a contact separation of at least 3 mm in each pole shall be incorporated into the electrical installation of the rack or building.
17. **FOR UNITS EQUIPPED WITH EXTERNALLY ACCESSIBLE FUSE RECEPTACLE:** Replace fuse with same type and rating only.
18. **MULTIPLE-INPUT VOLTAGE:** This equipment may require the use of a different line cord, attachment plug, or both, depending on the available power source at installation. Connect this equipment only to the power source indicated on the equipment rear panel. To reduce the risk of fire or electric shock, refer servicing to qualified service personnel or equivalent.
19. **WARNING:** The mains plug/appliance coupler is used as disconnect device, the disconnect device shall remain readily operable.

Copyright 2014 - Samson Technologies Corp.
V1

Samson Technologies Corp.
45 Gilpin Avenue
Hauppauge, New York 11788-8816
Phone: 1-800-3-SAMSON (1-800-372-6766)
Fax: 631-784-2201
www.samsontech.com

Introduction

Thank you for purchasing the Samson Auro D1200 or D1500 powered subwoofer. The Auro D1500 is a self-powered subwoofer with a 15" woofer and 1,000 Watt class-D power amplifier. The Auro D1200 is a compact and powerful speaker cabinet featuring a 12", long excursion driver, and complemented by a 700 Watt class-D power amplifier. The subwoofer offers stereo, full-range outputs for running your satellite speakers or linking multiple subwoofers together to create larger sound reinforcement systems. The Auro D1500 also includes high-pass outputs, which follows the internal low-pass filter setting, as well as RCA inputs for connecting to an unbalanced audio device such as a DJ mixer or home theater system.

The Auro enclosure is constructed of cabinet grade plywood, covered in heavy-duty textured black polyurethane paint and includes oversized steel handles offering excellent protection against wear and tear. The Auro active subwoofer is ideal for live music, DJ, and installed sound applications, or anywhere serious power and superior sound quality are desired.

In these pages, you'll find a detailed itemization of the features of the Auro powered subwoofer, as well as a description of its controls, step-by-step instructions for its setup and use, and full specifications. You'll also find a registration card enclosed—please don't forget to fill it out and mail it in so that you can receive online technical support, and so that we can send you updated information about this and other Samson products. Also, be sure to check out our website (www.samsontech.com) for complete information about our full product line.

With proper care and adequate air circulation, your Auro subwoofer will operate trouble free for many years. We recommend you record your serial number in the space provided below for future reference.

Serial number: _____

Date of purchase: _____

Should your unit ever require servicing, a Return Authorization (RA) number must be obtained before shipping your unit to Samson. Without this number, the unit will not be accepted. Please call Samson at 1-800-3SAMSON (1-800-372-6766) for an RA number prior to shipping your unit. Please retain the original packing materials and, if possible, return the unit in its original carton and packing materials. If you purchased your Samson product outside the United States, please contact your local distributor for warranty and service information.

Auro D1200 and D1500 Features

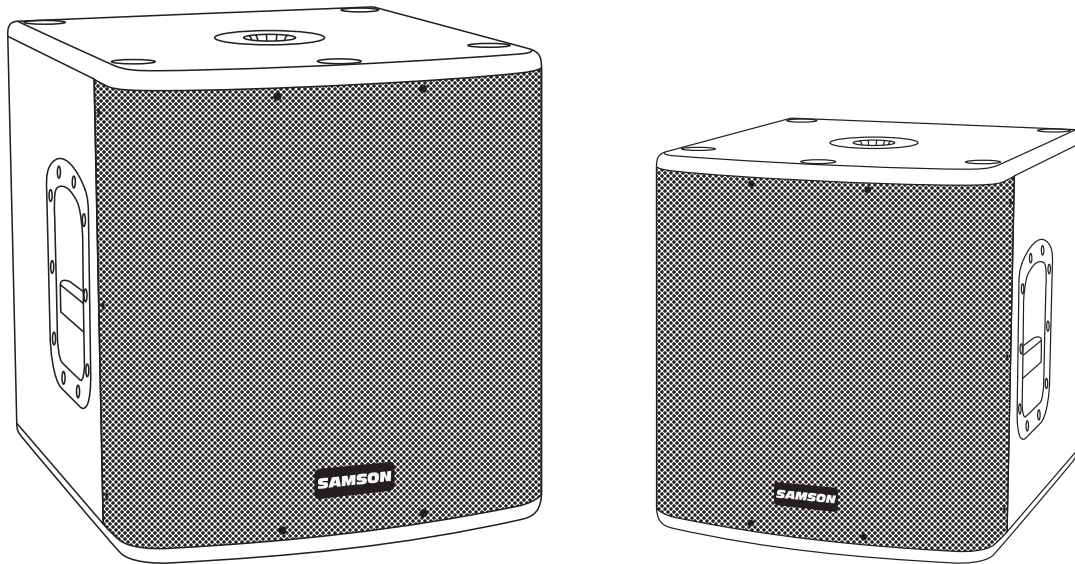

The Samson Auro D1200 and D1500 powered subwoofers utilize the latest technology in loudspeaker and power amplifier design. Here are some of its main features:

- Heavy-duty, 15" for the D1500 and 12" for the D1200 low frequency transducer
- D1200 features a built-in 700 Watt, highly efficient class-D power amplifier
- D1500 features a built-in 1000 Watt, highly efficient class-D power amplifier
- Dual balanced XLR / ¼" combo inputs
- Stereo unbalanced RCA inputs on the D1500
- Dual parallel XLR full range outputs
- Auro D1500 includes dual parallel XLR high-pass outputs
- Variable low pass filter control (80Hz - 200Hz)
- Three-position DSP contour control to adjust the tonal characteristic of the subwoofer
- Selectable polarity control
- Two large, steel carry handles
- 1⅜" (35mm) pole mount receptacle
- Heavy-duty steel grill
- Internally braced, plywood construction
- Durable textured black polyurethane paint

Quick Start

Unpack the Auro subwoofer and all included components. Be sure to save the packaging in case you ever move, or need to send the unit for service.

Set the Auro subwoofer and satellite speaker(s) appropriately for the performance venue. The enclosure has a 1³/₈" speaker pole receptacle, so you can mount a satellite speaker directly on top of the subwoofer using a satellite mounting pole (such as the Samson TS20).

Turn all speakers off, and turn the level controls completely down (figure 1).

Connect a line-level signal from your mixer (or other source) to a LINE INPUT jack on the Auro subwoofer. If you are using a single subwoofer with stereo satellite speakers, connect the left and right output of the mixer to the stereo (Channel A & B) input jacks on the Auro D1200 or D1500 (figure 2).

Connect an XLR cable from the THRU output of the Auro D1200 or HIGH PASS output of the Auro D1500 to the line input of your active satellite speaker(s) or power amplifiers (figure 3).

Plug the supplied power cable into an AC outlet and turn the Power switch on your Auro subwoofer and satellite speaker(s) to the ON position.

Note: Always make sure that the AC outlet used with this unit is configured with the correct voltage, as indicated on the rear panel of the Auro loudspeaker.

Run an audio signal (such as music from an MP3 player) from your mixer, and check that you are getting good levels using the mixer's output meter.

Slowly raise the satellite speaker(s) level control until you have reached a comfortable level. Then raise the Auro subwoofer LEVEL control until you have reached a level that sits well within the rest of the mix (figure 4).

If you notice the LIMITER indicator blinking frequently, turn down the LEVEL control on the Auro subwoofer until the LIMITER indicator does not light, or only lights occasionally with signal peaks.

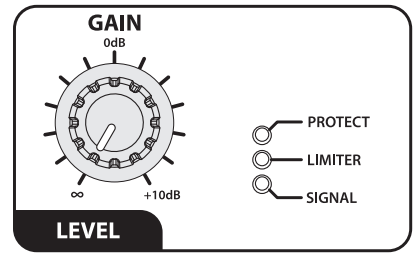

Figure 1

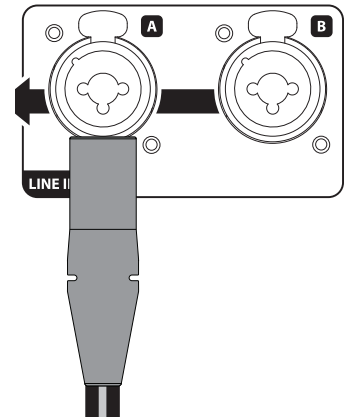

Figure 2

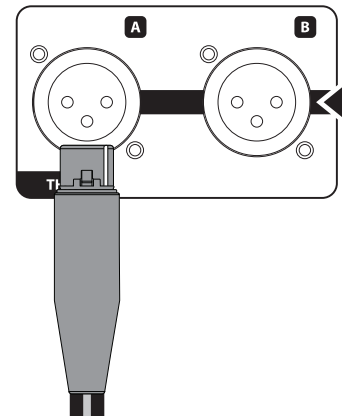

Figure 3

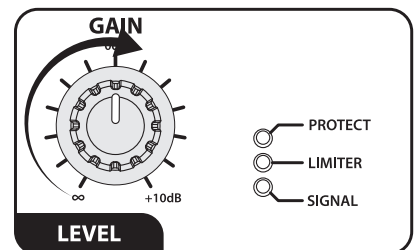
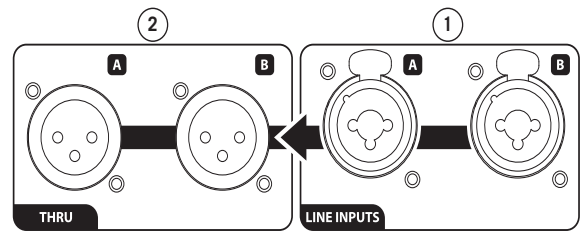

Figure 4

Inputs and Outputs

- 1. LINE INPUTS (D1200)** - The D1200 features balanced XLR / ¼" stereo line inputs. The left (A) and right (B) input signals are mixed together before they are routed to the internal amplifier.
- 2. THRU Outputs (D1200)** - Full range male XLR stereo line outputs. These outputs can be used to connect another subwoofer, or send full range signal to your main PA loudspeakers.
- 3. Balanced LINE INPUTS (D1500)** - The D1500 features balanced XLR / ¼" stereo line inputs. The left (A) and right (B) input signals are mixed together before they are routed to the internal amplifier.
- 4. Unbalanced RCA Inputs (D1500)** - The D1500 features unbalanced RCA stereo inputs. The left (A) and right (B) input signals are mixed together before they are routed to the internal amplifier.
- 5. THRU Outputs (D1500)** - Full range male XLR stereo line outputs. These outputs can be used to connect another subwoofer, or send full range signal to your main PA loudspeakers.
- 6. HIGH PASS Outputs (D1500)** - Male XLR stereo high pass line outputs follow the internal Low Pass Filter frequency. These outputs are used to connect to your main PA loudspeakers.



Auro D1200

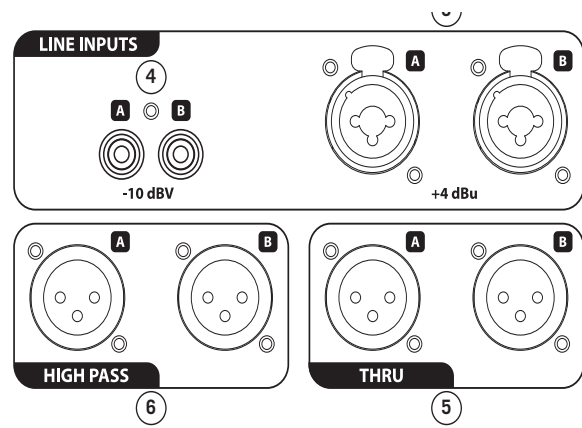

Auro D1500

Controls and Functions

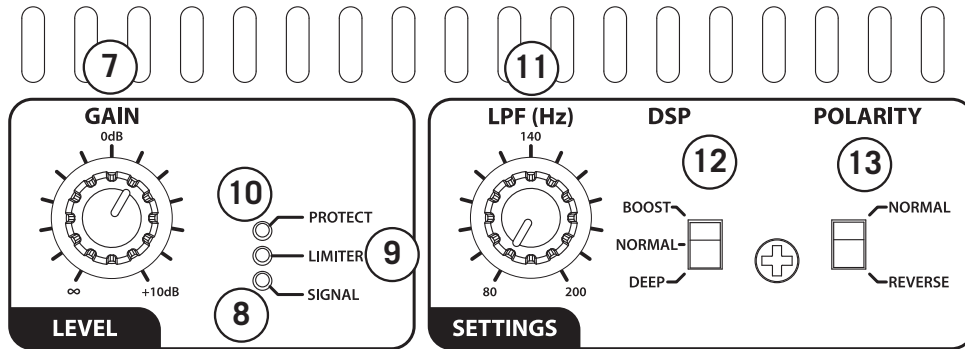

7. **GAIN Control** - This control adjusts the overall signal level at the input of the internal power amplifier. This control does not affect the signal sent to the THRU outputs.
8. **SIGNAL Indicator** - The green SIGNAL LED lights whenever signal is present at the D1200's inputs.
9. **LIMITER Indicator** - This yellow LED lights when the amp is near the clipping point and the limiter is engaged. If the LIMITER indicator lights frequently, turn down the GAIN control on the Auro subwoofer or turn down the signal at the source, until the indicator does not light anymore, or lights only occasionally with high signal peaks.
10. **PROTECT Indicator** - This LED lights RED when the amp overheats or other problems have been detected. If the PROTECT indicator lights due to the level being too high, the amplifier will limit the audio and lower the output level. Turn the GAIN control down until the PROTECT indicator is no longer lit. When the unit cools, the amplifier will raise the level back up.
11. **LPF (Hz)** - Adjusts the low frequency filter end range of the subwoofer from 80Hz-200Hz. This setting does not affect the signal sent to the THRU outputs.
12. **DSP** - The Auro D1200 DSP has three EQ contour curves: NORMAL, DEEP, and BOOST. The NORMAL setting produces the standard frequency response for the subwoofer and works best for most applications. BOOST enhances frequencies at 100Hz to add punch and strengthen the kick drum frequency band. The DEEP setting extends the low frequencies down to widen the range of the subwoofer.
Note: While the DEEP setting might increase the low frequency response of the Auro D1200, low frequencies use more power and reduce the overall headroom of the amplifier.
13. **POLARITY Switch** - Use this switch to set the polarity of the amplified signal. In the NORMAL setting, there is no change to the signal. When the switch is set to the in REVERSE setting, the signal's polarity is changed by 180°. The setting of the POLARITY switch has no effect on the signal sent to the THRU outputs.
14. **AC INPUT** - Connect the supplied standard IEC AC power cable here.
15. **POWER Switch** - Switches on the Auro D1200 main power.
16. **Voltage Switch** - Slide to change the operating voltage from 115 to 230 volts.

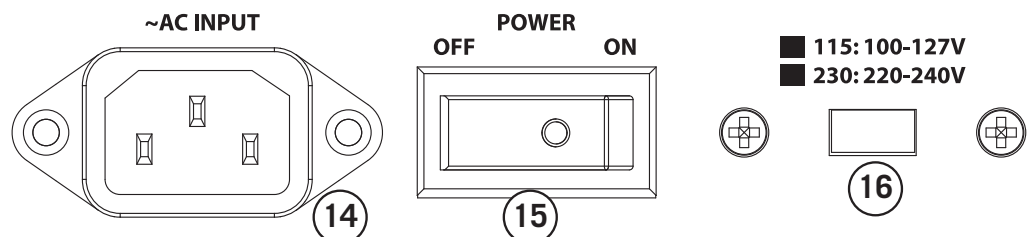

Mono Sub Operation

In most cases, a common (mono) sub bass setup is preferable. Low frequencies produced by a subwoofer tend to be non-directional. Since low frequency waves take so much space to develop, it is difficult for the ear to tell if sub bass is coming from the left or right side (unless, of course you're in a very large room). Because of this phenomenon, just about all sub bass material is mixed in mono.

Follow the steps below for a system set-up using the Auro subwoofer with a mixer and a pair of powered satellite loudspeakers.

- Lower your mixer's master outputs until they are turned off.
- Connect the mixer's left output to the Auro subwoofer LINE INPUT A, and the mixer's right output to the LINE INPUT B.
- Connect the subwoofer's left (A) THRU output to the line input of the left side powered satellite, or power amplifier (if using passive speakers) and the right (B) THRU output to the line input of the right side satellite or power amplifier (if using passive speakers). If using the Auro D1500 you can utilize the High Pass (A) and (B) Outputs to eliminate the need for an external crossover.
- Set the level of your powered satellites up to normal operating level. Run an audio signal (such as music from an MP3 player) through your mixer, and raise the level to a comfortable listening volume.
- Slowly raise the subwoofer's LEVEL control to the desired low frequency output.
- When you raise and lower your mixer's output, the Auro subwoofer and satellite speakers will track at the same relative volume.



Stereo Sub Operation

In larger rooms two or more Auro subwoofers can be used in stereo. For additional low-end, you can daisy chain a pair of Auro subwoofers to each side of your speaker system using the parallel THRU outputs.

To create a stereo full range audio system, two Auro Subwoofers can be used with any pair of powered full range enclosures. Follow these steps below for a system set-up using two D1200 or D1500 subwoofers with a mixer and a pair of powered satellite loudspeakers.

- Lower your mixer's master outputs until they are turned off.
- Connect the mixer's left output to the left side Auro subwoofer LINE INPUT A, and the mixer's right output to the right side LINE INPUT B.
- If using the Auro D1200, connect the THRU A output to the line input of the left powered satellite, and the THRU B output to the line input of the right satellite. For the Auro D1500 connect HIGH PASS A output to the line input of the left powered satellite and the HIGH PASS B output to the line input of the right powered satellite.
- Set the level of your powered satellites up to normal operating level. Run an audio signal (such as music from a MP3 player) through your mixer, and raise the level to a comfortable listening volume.
- Slowly raise the Auro subwoofer LEVEL controls and adjust the two subwoofers to the desired level of low frequency output.
- When you raise and lower your mixer's output, the two Auro subwoofers and satellites will track at the same relative volume.

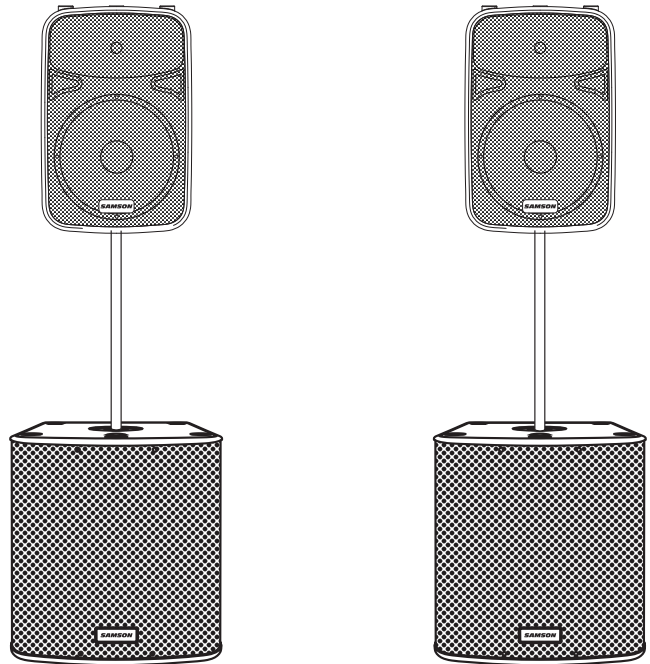

Setting the Low Pass Filter (LPF)

The Auro subwoofer LPF (low pass filter) control gives you the ability to tune the subwoofer to match your sound and room. The LPF control adjusts the internal crossover of the subwoofer from 80Hz-200Hz. Use the below points as guidelines when setting up your sound system, but always use and trust your ears when finding a setting that sounds good and fits your application.

The goal is to seamlessly integrate the subwoofer with the rest of your speakers to extend the frequency range of your system, rather than produce an unnatural, boomy mix. You do not want the subwoofer and the main speaker to reproduce the same frequencies, as this will create duplication of low frequencies, and create an imbalanced mix.

A good place to start is to use the frequency response of your speaker cabinets. You can usually find this information in the documentation included with your speakers. Set the Auro subwoofer LPF to the lowest frequency that your satellite speaker produces.

If your satellite speakers are large (12" or 15") set the low pass filter to 80Hz. If your speakers are small (8" or 10") set the low pass filter in the 100Hz range. If you have an oscillator (there are many free oscillator smartphone and tablet apps available), slowly sweep from 400Hz down to 40Hz, and listen to how the subwoofer and speakers blend together. You may need to raise or lower the LPF control to create the smoothest frequency response. If you do not have an oscillator, use music tracks that have a steady bass line and kick drum. Slowly adjust the LPF until you find the optimum setting.

Polarity

A speaker reproduces sound by converting electrical signal into physical vibration, which pushes air to create sound waves. When setting up your speaker system, the goal is to have all speakers moving in phase, with the in and out movement of the speakers synchronized. This produces an even sound across all audible frequencies. If the subwoofer is out of phase with the full range front of house speakers, you may notice decreased bass response, or even bass frequency cancellation where satellite and subwoofer frequency responses overlap. Many times this phenomenon is very subtle, but it can produce the effect of "holes" in the music, and diminished bass frequencies.

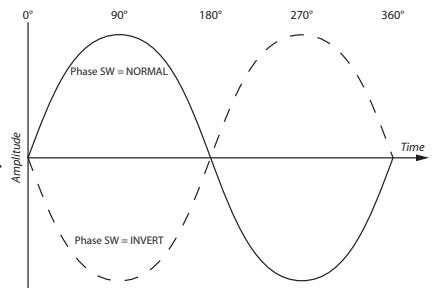

Ideally, your Auro subwoofer should be positioned on the same plane as your satellite speakers. In reality, we know this is difficult, as there are restrictions when setting up a PA system due to space limitations, speaker stand configuration, or even speaker cabinet shape. To compensate for these obstacles, the Auro subwoofer features a Phase switch, which allows you to reverse the polarity of the subwoofer relative to the source signal. This enables you to put the subwoofer in phase with the rest of your PA system, or 180° out of phase.

To determine if the audio produced by your subwoofer is in phase with the rest of your PA system, play an audio track containing a lot of bass frequencies through your speaker system. Stand at a good listening distance, where you can clearly hear the audio from the subwoofer(s) and mains speaker(s), and listen until you believe you have a good gauge of the level of bass frequencies. Press the Phase switch on the Auro subwoofer to reverse the phase by 180°, and move back to your original listening position. Compare the overall level of the bass frequencies between the two settings. The correct setting will result in more bass frequencies. If the situation allows, you can fine-tune the phase of your subwoofer to your satellite speakers by moving the relative position of the subwoofer closer or further away from the listening position.

Specifications

Auro D1200

Power	700 watts
Design	Class-D
Transducer	12" paper cone, 2.5" voice coil diameter
Sensitivity	95dB SPL @ 1w/1m
Frequency Response	45Hz - 200Hz (+/-3 dB)
Max. SPL (700 watts)	126 dB SPL @ 1m
Crossover Type	24 dB/oct Linkwitz-Riley
Crossover Frequency	80Hz-200Hz
Inputs	2 x Balanced Female XLR / ¼ Combo
Thru Outputs	2 x Balanced Male XLR
Controls	Master Level Rotary, DSP Switch, Phase Switch, LPF Rotary
Indicators	Signal, Limiter, Protect
Power Consumption	800 W max.
AC Connector	3-pin IEC 250 VAC, 20 A male
Fuse	250V / T5AH
Construction	15 mm plywood
Finish	Textured black polyurethane paint
Handles	2 x Steel
Grill	Perforated steel
Mounting Method	Integral 1 3/8" (35 mm) Pole Mount Receptacle
Dimensions (LxWxH)	15.55" x 19" x 18" / 395 mm x 483.5 mm x 457 mm
Weight	42 lb / 19 kg

Auro D1500

Power	1000 watts
Design	Class-D
Transducer	15" paper cone, 2.5" voice coil diameter
Sensitivity	91dB SPL @ 1w/1m
Frequency Response	40Hz - 200Hz (+/-3 dB)
Max. SPL (700 watts)	131 dB SPL @ 1m
Crossover Type	24 dB/oct Linkwitz-Riley
Crossover Frequency	80Hz-200Hz
Inputs	2 x Balanced XLR / ¼ Combo, Stereo Unbalanced RCA
Thru Outputs	2 x Balanced XLR High Pass, 2 x Balanced XLR Full Range
Controls	Master Level Rotary, DSP Switch, Phase Switch, LPF Rotary
Indicators	Signal, Limiter, Protect
Power Consumption	800 W max.
AC Connector	3-pin IEC 250 VAC, 20 A male
Fuse	250V / T5AH
Construction	18 mm plywood
Finish	Textured black polyurethane paint
Handles	2 x Steel
Grill	Perforated steel
Mounting Method	Integral 1 3/8" (35 mm) Pole Mount Receptacle
Dimensions (LxWxH)	17.7" x 19.7" x 20.9" / 450 mm x 500 mm x 530 mm
Weight	53.7 lb / 24.4 kg

At Samson, we are continually improving our products, therefore specifications and images are subject to change without notice.

Samson Technologies Corp.
45 Gilpin Avenue
Hauppauge, New York 11788-8816
Phone: 1-800-3-SAMSON (1-800-372-6766)
Fax: 631-784-2201
samsontech.com