

EDGE25P

Features

- WTW configuration with a spherical waveguide
- Easily configurable in small arrays

Description

The EDGE25P is a 2 way, full range passive system with an internal crossover and a PTC protection for the tweeter. Designed for near-field applications such as television, stage front, conferences theatres etc. The system is characterised by 2 x 5.25" woofers and a dome tweeter with a SWGH (Spherical Wave Guide Horn) in a WTW configuration. The trapezoid cabinet is asymmetric to allow positioning in small arrays. Among the characteristics of the system are elevated angular dispersion, homogenous coverage and a high sensibility.

The speaker has the impedance of 16 ohm allowing many to be coupled together in parallel. Version with 100 V constant voltage line transformer is also available, EDGE25TB black and EDGE25TW white.



Technical Characteristics

System	
System Type	2-way vented enclosure
Frequency Response	125 Hz - 20 kHz (± 6 dB)
Coverage Angle H. (-6 dB)	80° averaged, 1 kHz to 20 kHz
Coverage Angle V. (-6 dB)	65° averaged, 1 kHz to 20 kHz
Directivity Index (DI)	10 averaged, 1 kHz to 20 kHz
Maximum Peak Output	116 dB @ 1m
Input Power Rating	100 W AES, 200 W program
Sensitivity	93 dB SPL (4 V @ 1m)
Nominal Impedance	16 Ω
Constant voltage transformer	optional 100 V EDGE25TB black, EDGE25TW white
Transducers	
Low Frequency Device	2 x 5.25" woofer
High Frequency Device	dome tweeter with SWGH
Mechanical Data	
Construction	monitor taper 20° 15 mm birch plywood with paint finish
Color	black EDGE25PB, white EDGE25PW
Flying Points	2 x M8 - top, bottom 1 x M10 - rear
Dimensions (WxHxD)	17.6 x 46 x 19 cm
Weight	7 kg

Architects' and Engineers' Specifications

The system shall be passive two way with a frequency response from 125 Hz to 20 kHz and an 80°H x 65°V coverage angle. The system shall have a dome tweeter set up on a spherical wave guide in a WTW configuration. The system shall also have two 8 ohm, 5.25" woofers connected in series with the power handling of 100 W AES. The speakers shall have 2 x M8 hanging points positioned on the top and bottom and an M10 attachment point positioned on the rear of the cabinet. The speaker shall be constructed from 15 mm Birch plywood in an asymmetrical trapezoid shape with a monitor angle of 20°. The height shall be 44.5 cm, width 16.5 cm and depth of 17 cm. The system shall be called the Proel EDGE25P.

3. Technical specifications

Dimensions

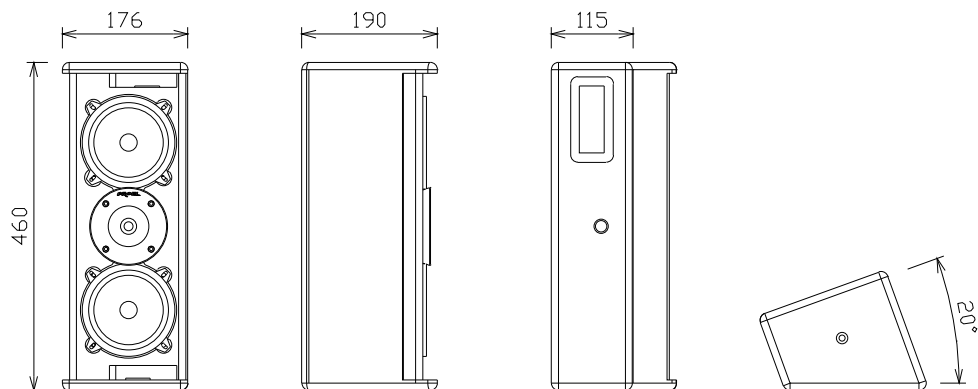

Connections

2 Neutrik Speakon NL4MP connectors in parallel.

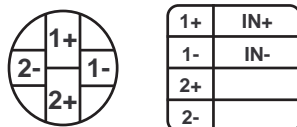

Graphics

Frequency response:

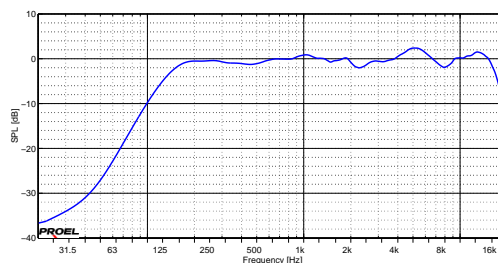

Directivity index:

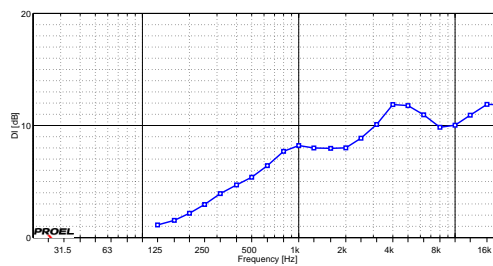

Beamwidth diagram (-6 dB):

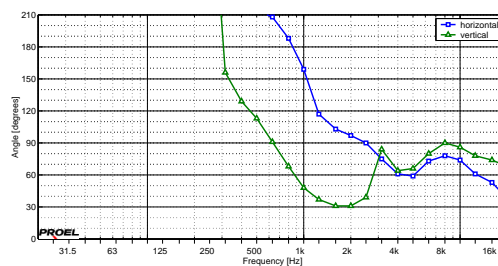

3. Technical specifications

Attenuation map (horizontal):

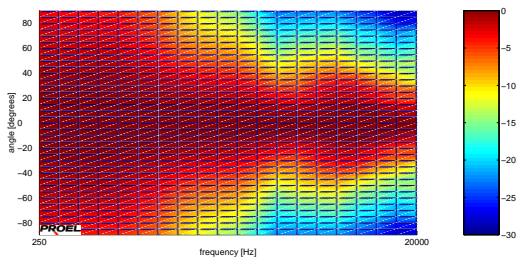

Polar diagram (horizontal):

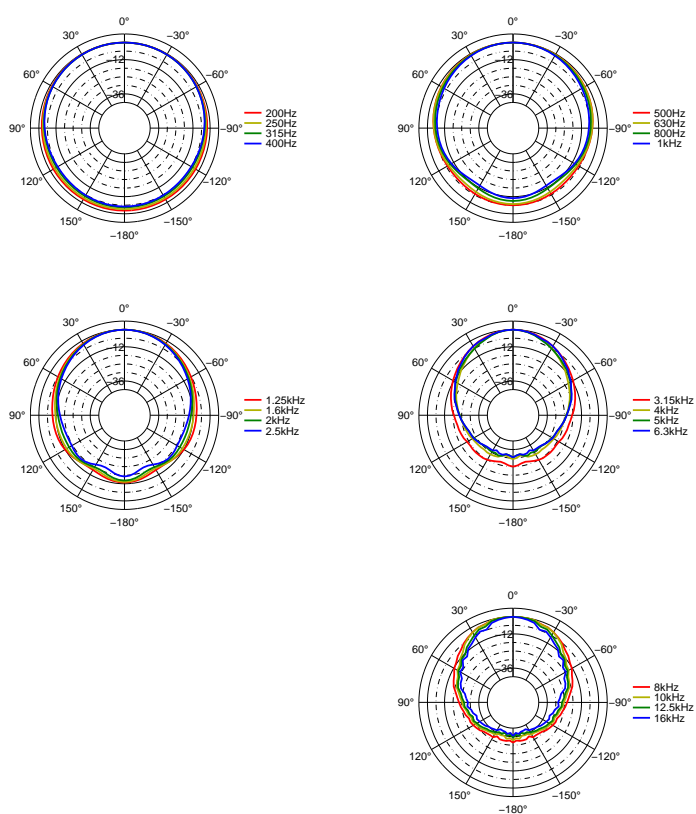

Attenuation map (vertical):

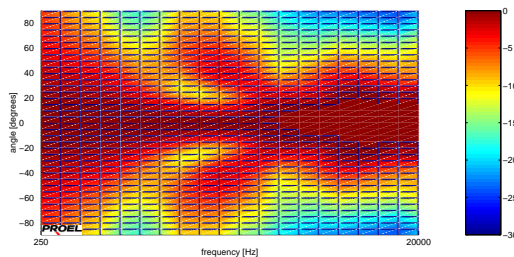

Polar diagram (vertical):

