

apollo 8p

HIGH-RESOLUTION INTERFACE
with Realtime UAD Processing



Apollo 8p Hardware Manual

Manual Version 171101



UNIVERSAL AUDIO

www.uaudio.com

A Letter from Bill Putnam Jr.

Thank you for deciding to make an Apollo High-Resolution Interface part of your music making experience. We know that any new piece of gear requires an investment of time and money — and our goal is to make your investment pay off. The fact that we get to play a part in your creative process is what makes our efforts meaningful, and we thank you for this.

In many ways, the Apollo family of audio interface products represent the best examples of what Universal Audio has stood for over its long history; from UA's original founding in the 1950s by my father, through our current vision of delivering the best of both analog and digital audio technologies.

Starting with its high-quality analog I/O, Apollo's superior sonic performance serves as its foundation. This is just the beginning however, as Apollo products are the only audio interfaces that allow you to run UAD plug-ins in real time. Want to monitor yourself through a Neve® console channel strip while tracking bass through a classic Fairchild or LA-2A compressor? Or how about tracking vocals through a Studer® tape machine with some added Lexicon® reverb?* With our growing library of more than 90 UAD plug-ins, the choices are limitless.

At UA, we are dedicated to the idea that this powerful technology should ultimately serve the creative process — not be a barrier. These are the very ideals my father embodied as he invented audio equipment to solve problems in the studio. So as you begin to incorporate Apollo into your creative process, we hope that the excitement and pride that we've built into it comes through. We believe Apollo will earn its way into your creative workflow by providing stunning fidelity, great ease-of-use, and rock-solid reliability for years to come.

As always, please feel free to reach out to us via our website www.uaudio.com, and via our social media channels. We look forward to hearing from you, and thank you once again for choosing Universal Audio.

Sincerely,

A handwritten signature in black ink, appearing to be 'Bill Putnam Jr.', written in a cursive style.

Bill Putnam Jr.

**All trademarks are recognized as property of their respective owners. Individual UAD Powered Plug-Ins sold separately.*

Table Of Contents

Tip: Click any section or page number to jump directly to that page.

A Letter from Bill Putnam Jr.	2
Introduction	4
Welcome to Apollo 8p!	4
Apollo 8p Features.....	6
Apollo 8p Documentation Overview.....	8
Additional Resources	9
Front Panel	10
Rear Panel	21
Digital I/O	22
Analog I/O	25
Interconnections.....	28
Installation Notes	28
Basic Setup	29
Typical Setup	30
Advanced Setup	31
Apollo Expanded: Multi-Unit Wiring.....	32
Software Setup.....	33
Specifications	34
Block Diagram.....	38
Troubleshooting	39
Notices.....	40
Important Safety Information	40
Warranty	41
Maintenance	41
Repair Service.....	41
Technical Support.....	43
Universal Audio Knowledge Base.....	43
YouTube Support Channel.....	43
UAD Community Forums	43
Contact UA Support	43

Introduction

Welcome to Apollo 8p!

Next-Generation Conversion with Eight Onboard Preamps

Apollo 8p is a dramatic update to one of the world's most popular professional audio interfaces, delivering enhanced sound with the tone, feel, and flow of analog recording. This 16 x 20 Thunderbolt 2 interface features eight onboard Unison™ mic preamps — perfect for mobile rigs and tracking full bands.

Built on genuine UA analog design and next-generation A/D and D/A conversion, Apollo 8p also features powerful UAD-2 QUAD Core processing, letting you run UAD Powered Plug-Ins in real time. With sound that surpasses anything in its class, Apollo 8p rivals modular converters costing twice the price, in a sleek new package.

World-Class Sound with Superior Apollo A/D and D/A Conversion

The original Apollo, introduced in 2012, quickly became a gold standard among modern music producers and engineers — it now counts many of the world's top artists as users. Apollo 8p improves upon the original Apollo's sound quality with completely redesigned, class-leading A/D and D/A conversion — giving you increased dynamic range and even lower THD.

Building upon a 50-year legacy of circuit design, UA engineers started with obsessive auditioning of the latest converters, pairing them with completely redesigned analog circuitry. After extensive double-blind listening tests, the result is 3 dB better dynamic range on both A/D and D/A conversion versus the original Apollo, placing the Apollo 8p as the measurable class leader.

Realtime UAD Plug-In Processing for Tracking, Mixing, and Mastering

Imagine having a classic analog studio, in single rack space. Apollo 8p lets you record through UAD Powered Plug-Ins — including vintage EQs, compressors, reverbs, tape machines and more — at near-zero latency, regardless of your audio software buffer size. With award-winning UAD plug-ins from Ampex, Lexicon, Neve, Manley, SSL, Studer, and more,* Apollo 8p serves up authentic analog tone and warmth.

The key to its analog sound is onboard UAD-2 QUAD DSP Processing, which powers the UAD plug-ins while reducing the strain on your host computer.

Apollo 8p comes bundled with “Realtime Analog Classics Plus” suite of UAD plug-ins. From there, you can choose from a vast and expanding collection of plug-ins in the UA Online Store.

**All trademarks are recognized as property of their respective owners. Individual UAD Powered Plug-Ins sold separately.*

Eight Mic Preamps with Unison™ Technology

Apollo 8p comes equipped with eight Unison-enabled mic preamps, letting you track larger projects with colorful mic preamp sounds from Neve, API, and Universal Audio. An Apollo breakthrough, Unison technology nails the tone of these sought-after tube and solid state mic preamps — including their impedance, gain stage “sweet spots,” and component-level circuit behaviors.

The secret to Unison is its hardware-software integration between Apollo’s mic preamps and its onboard UAD-2 processing. Simply place a selected tube or solid state preamp plug-in on your desired mic input, and record in real time through stunning emulations like the bundled UA 610-B Tube Preamp plug-in, or the Neve 1073 and API 212L.

Impedance and Gain Matching

Apollo 8p also includes Unison technology on its front panel instrument inputs, giving you dead-on emulations of guitar and bass amps like the Fender ‘55 Tweed Deluxe, Marshall Plexi Super Lead 1959, and Ampeg B-15N Bass Amplifier, as well as iconic stompboxes.

Improved Monitoring and Workflow

Apollo 8p features a host of front-panel upgrades over the original Apollo, including Alt Speakers, Dim, and Mono functions as well as input and output metering capabilities.

Expands Your System

Thanks to Apollo Expanded software, users of Thunderbolt-equipped Apollo Twin, Apollo 8, Apollo 8p, and Apollo 16 audio interfaces can combine up to four Apollos and six total UAD-2 devices — adding I/O and DSP as your studio grows. Apollo Expanded also provides seamless integration with previous generation Apollos over Thunderbolt.

A Sleek New App

With Apollo 8p’s Console 2.0 application — a complete re-imagining of Apollo’s original Console software — you can take advantage of over 25 new user-requested features such as Channel Strip presets, Drag & Drop functionality, dynamically resizable windows, and more.

Apollo 8p Features

Key Features

- Next-generation Apollo A/D and D/A conversion for professional music production
- 8 Unison™-enabled mic preamps for tracking full bands through preamp emulations from Neve, API, and Universal Audio
- Onboard UAD-2 QUAD Core DSP allows Realtime UAD Processing
- 16 x 20 Thunderbolt 2 audio interface with powerful Console 2.0 software control
- Cascade up to 4 Apollo interfaces and 6 UAD devices total over Thunderbolt
- Convenient front panel monitoring functions including Alt Speakers, Dim, and Mono
- Includes “Realtime Analog Classics Plus” plug-in bundle
- World class UA analog design, superior components, and premium build quality

Audio Interface

- Sample rates up to 192 kHz at 24-bit word length
- 16 x 20 simultaneous input/output channels
- Eight channels of analog-to-digital conversion via mic, line, or high-impedance inputs
- 12 channels of digital-to-analog conversion via:
 - Six mono line outputs
 - Stereo monitor outputs (switchable to fixed line outputs)
 - Two stereo headphone outputs
- Eight channels of digital I/O via:
 - Eight channels ADAT Optical Lightpipe I/O with S/MUX for high sample rates
 - Lightpipe I/O can be switched to S/PDIF optical with sample rate conversion
- Two Thunderbolt 2 ports facilitates daisy-chaining of other Thunderbolt devices

Microphone Preamplifiers

- Eight high-resolution, ultra-transparent, digitally-controlled analog mic preamps
- Unison™ technology for deep integration with UAD preamp and pedal plug-ins
- Front panel and software control of all preamp parameters
- Switchable low cut filter, 48V phantom power, pad, polarity inversion, and stereo linking

Monitoring

- Stereo monitor outputs (independent of the six line outputs)
- Digitally-controlled analog monitor outputs maintains highest fidelity
- Front panel control of monitor levels and muting
- Two stereo headphone outputs with independent mix buses
- Independent front panel volume controls for headphone outputs
- Front panel pre-fader metering of monitor bus levels
- S/PDIF outputs can be set to mirror the monitor outputs
- Up to two alternate stereo monitor outputs selectable via front panel or Console software
- Assignable front panel monitor function switch for alternate speakers, dim, & mono

UAD-2 Inside

- QUAD Core DSP with four SHARC® processors
- Realtime UAD Processing on all analog and digital inputs via Console application
- Same features and functionality as other UAD-2 devices when used with DAW
- Can be combined with other UAD-2 devices for increased mixing DSP
- Includes UAD Powered Plug-Ins “Realtime Analog Classics Plus” bundle
- Complete UAD plug-ins library is available at the UA online store

Software

Console application:

- Analog-style control interface for realtime monitoring and tracking
- Enables Realtime UAD Processing with UAD plug-ins
- Remote control of Apollo 8p features and functionality
- Virtual I/O for routing DAW tracks through Console

Console Recall plug-in:

- Saves Console configurations inside DAW sessions for easy recall
- Convenient access to Console’s monitor controls via DAW plug-in
- VST, RTAS, AAX 64, and Audio Units plug-in formats

UAD Meter & Control Panel application:

- Configures global UAD settings and monitors system usage

Other

- Easy firmware updates
- 1U rack-mountable form factor
- One year warranty includes parts and labor

Apollo 8p Documentation Overview

Documentation for Apollo 8p and UAD Powered Plug-Ins are separated by areas of functionality, as described below. The user manuals are placed on the system drive during software installation, and they can be downloaded at www.uaudio.com.

Apollo Manual Files

***Note:** All manual files are in PDF format. PDF files require a free PDF reader application such as [Adobe Reader](#) (Windows & Mac) or [Preview](#) (Mac).*

Apollo Hardware Manuals

Each Apollo model has a unique hardware manual. The Apollo hardware manuals contain complete hardware-related details about one specific Apollo model. Included are detailed descriptions of all hardware features, controls, connectors, and specifications.

***Note:** Each hardware manual contains the unique Apollo model in the file name.*

Apollo Software Manual

The Apollo Software Manual is the companion guide to the Apollo hardware manuals. It contains detailed information about how to configure and control all Apollo software features using the Console application, Console Settings window, and Console Recall plug-in. Refer to the Apollo Software Manual to learn how to operate the software tools and integrate Apollo's functionality into the DAW environment.

***Note:** Each Apollo connection protocol (Thunderbolt, FireWire, USB) has a unique software manual.*

UAD System Manual

The UAD System Manual is the complete operation manual for Apollo's UAD-2 functionality and applies to the entire UAD-2 product family. It contains detailed information about installing and configuring UAD devices, the UAD Meter & Control Panel application, buying optional plug-ins at the UA online store, and more. It includes everything about UAD except Apollo-specific information and individual UAD plug-in descriptions.

UAD Plug-Ins Manual

The features and functionality of all individual UAD Powered Plug-Ins is detailed in the UAD Plug-Ins Manual. Refer to this document to learn about the operation, controls, and user interface of each UAD plug-in that is developed by Universal Audio.

Direct Developer Plug-In Manuals

UAD Powered Plug-Ins includes plug-in titles created by our Direct Developer partners. Documentation for these 3rd-party plug-ins are separate files written and provided by the plug-in developers. The file names for these plug-in manuals are the same as the plug-in titles.

Accessing Installed Documentation

Any of these methods can be used to access installed documentation:

- Choose “Documentation” from the Help menu within the Console application
- Click the “Product Manuals” button in the Help panel within the UAD Meter & Control Panel application
- Manuals are also available online at help.uaudio.com

Host DAW Documentation

Each host DAW software application has its own particular methods for configuring and using audio interfaces and plug-ins. Refer to the host DAW’s documentation for specific instructions about using audio interface and plug-in features within the DAW.

Additional Resources

For additional resources, or if you need to contact Universal Audio for assistance, see the [Technical Support](#) page.

(2) Preamp Gain & Channel Select Knob

This rotary encoder with integrated switch serves three functions. Each function is detailed below.

Rotate – Rotating the knob adjusts the preamp gain for the selected input channel.

Press – Pressing the knob selects which preamp channel (1 – 8) is adjusted by the front panel preamp controls.

Press+Hold – When a Unison plug-in is active in the channel's dedicated Unison insert within the Console application, pressing and holding the knob enters/exits Unison Gain Stage Mode.

Each of the three functions above is explained in greater detail below.

Preamp Gain

The preamp gain of analog inputs 1 – 8 is adjusted with the rotary control. The channel to be adjusted is set with the Channel Select (press) function. The input to be adjusted (Mic, Line, or Hi-Z) is determined by the state of the channel's Mic/Line switch (#4) or Hi-Z input (if connected).

Rotating the knob clockwise increases the preamp gain for the selected channel. The available gain range for preamp channels is 10 dB to 65 dB for the Mic, Line, and Hi-Z inputs.

More than one full revolution is needed to move through the available range. This feature increases the control resolution for more precise preamp gain adjustments.

***Tip:** To adjust signal levels for inputs 9 – 16, use the output level controls of devices connected to those inputs.*

Line Input Gain Bypass

By default, line inputs 1 – 8 are routed through the channel's preamp so the line input level can be adjusted with the Gain knob. However, line inputs 1 – 8 can be individually set to completely bypass the channel's preamp circuitry and instead be routed directly to the channel's A/D converter at a fixed reference level. This feature is set with the LINE INPUT GAIN menu in the Hardware panel within the Console Settings window.

***Tip:** This feature routes the preamp channel's line input signal directly into the A/D converter for the purest path when additional gain is not needed (for example, when connecting external mic preamps to preamp channel line inputs).*

When the channel's LINE INPUT GAIN menu is set to BYPASS in Console Settings:

- The Preamp Gain Indicator ring (#3) for the channel is solid green
- When the Gain knob (#2) is rotated, the ring flashes to indicate that no gain adjustment is occurring
- If a Unison plug-in is in the channel's dedicated Unison insert in Console, the Unison plug-in is bypassed

Channel Select

Pressing the Preamp Knob changes the currently selected preamp channel, which determines which input (1 – 8) is adjusted by the front panel preamp controls. A preamp channel is selected for adjustment when its Channel Select Indicator (#11) is illuminated.

Each time the knob is pressed, the selected channel increments to the next channel. If stereo linking is active, the stereo pairs are selected.

Gain Stage Mode

Gain Stage Mode is activated by pressing and holding the Preamp knob for two seconds when a Unison plug-in is active in the channel's dedicated Unison insert within the Console application. When Gain Stage Mode is active, pressing and holding the knob for two seconds deactivates Gain Stage Mode.

Gain Stage Mode is active when the Channel Select Indicator (#11) for the currently selected channel is flashing. In this state, pressing the Gain knob cycles through the available gain parameters within the Unison plug-in so each gain stage in the plug-in can be adjusted from the front panel.

Note: For complete details about Gain Stage Mode, see the Unison chapter within the [Apollo Software Manual](#).

(3) Preamp Gain Level & State Indicator

Preamp Gain Level Indicator

The amount of preamp gain for the currently selected channel is indicated by the illuminated ring surrounding the Preamp knob.

The ring indicates relative gain levels and is not calibrated to indicate any specific dB value. However, precise numerical dB gain values for the preamps are displayed within the Console application.

Note: If the ring is at maximum and flashes when the Preamp knob is rotated, the channel's LINE input is selected and LINE INPUT GAIN is set to BYPASS. See [Line Input Gain Bypass](#) for additional details.

Preamp State Indicator

In addition to the channel's relative preamp gain, the ring also indicates the current state of the preamp channel:

Green (variable) – The preamp is in default operating mode with variable gain

Green (fixed at maximum) – LINE is selected for the channel (#4) and LINE INPUT GAIN is set to BYPASS in the Hardware panel within the Console Settings window

Unlit – The preamp gain is set to its minimum value

Orange – A Unison plug-in is active in Console's dedicated Unison insert for the channel.

***Note:** See the Unison chapter within the [Apollo Software Manual](#) for complete details about Unison operation.*

(4–9) Preamp Options

This set of six switches control the preamp options for input channels 1 – 8. Press the switches to toggle the setting. The current state of each preamp option is indicated by the LED within each button. Each switch function is detailed below.

(4) Mic/Line

This switch switches between the channel's Mic (XLR) and Line (1/4") inputs on the rear panel combo jacks. This switch has no effect if the channel's Hi-Z input is connected (the Hi-Z input must be disconnected to use the Mic/Line inputs).

***Note:** Line inputs 1 – 8 can be set to bypass the preamp circuitry. See [Line Input Gain Bypass](#) for additional details.*

(5) Low Cut Filter

When enabled, the channel's input signal passes through a low cut (high pass) filter. This 2nd-order coincident-pole filter has a cutoff frequency of 75 Hz with a slope of 12 dB per octave.

The Low Cut filter affects the Mic, Line, and Hi-Z inputs. Low Cut is typically used to eliminate rumble and other unwanted low frequencies from the input signal.

(6) Phantom Power (+48V)

When enabled, 48 volts of phantom power is supplied at the channel's rear panel XLR input. Most modern condenser microphones require 48V phantom power to operate. This option can only be activated when the Mic/Line switch (#4) is set to Mic.

***Caution:** To avoid potential equipment damage, disable +48V phantom power on the channel before connecting or disconnecting its XLR input.*

Depending on the current configuration of the hardware and software, there may be a delay when changing the 48V state to minimize the clicks/pops that are inherent when engaging phantom power. The +48V LED will blink rapidly during any delay.

(7) Pad

When enabled, the channel's XLR input signal level is attenuated by 20 dB. Pad does not effect the Line or Hi-Z inputs.

Pad can be used to reduce signal levels when overload distortion is present at low preamp gain levels, such as when particularly sensitive microphones are used on loud instruments, and/or if the A/D converter is clipping.

(8) Polarity (ø)

When enabled, the polarity (aka "phase") of the input channel's signal is inverted. Polarity affects the Mic, Line, and Hi-Z inputs.

Tip: Polarity inversion can help reduce phase cancellations when more than one microphone is used to record a single source.

(9) Stereo Link

This switch links the preamp controls of adjacent channels (1+2, 3+4, 5+6, 7+8) together to create stereo input pairs. When channels are linked as a stereo pair, any preamp control adjustments will affect both channels of the stereo signal identically.

Note: Only the same type of inputs can be linked (Mic/Mic or Line/Line). The Hi-Z inputs cannot be linked.

(10) Input Indicators

These indicators (MIC/LINE/HI-Z) display which input is currently active for the channel. To select MIC or LINE, use the INPUT switch (#4). To select Hi-Z, plug a ¼" mono TS cable into the Hi-Z input.

LINE indicator color

The color of the LINE indicator changes to reflect the state of the LINE INPUT GAIN setting, which is configured in the Hardware panel within the Console Settings window.

White – The line input is routed through the preamp so the input gain can be adjusted.

Green – The preamp circuitry is bypassed and the line input is fixed at a reference level of +4 dBu.

(11) Channel 1 – 8 Select Indicators

The currently selected preamp channel is indicated by the illuminated numbers above level meters 1 – 8. When a preamp channel (or channels, when stereo linked) is selected, its channel number is illuminated. The currently selected channel increments when the Preamp knob (#2) is pressed.

(12) Channel Level Meters

The 10-segment LED channel meters display the input or output signal peak levels for analog channels 1 – 8. Input or output metering is selected with the METER switch (#19), and the input/output state is shown by the METER indicators (#15).

The dB values of the meter LEDs are indicated between the meters for channels 4 and 5. When digital clipping occurs in input (when 0 dBFS is exceeded), the red “C” (clip) LED illuminates.

Input Channel Meters

When set to INPUT, the channel meters display the signal peak input levels for analog channels 1 – 8 at the input to the A/D converters.

Avoid digital clipping at the channel’s A/D converter by reducing the preamp gain and/or engaging the Pad (#7) and readjusting gain as needed, or reducing the output level of the device connected to the channel’s input.

Output Channel Meters

When set to OUTPUT, the channel meters display the signal peak output levels for analog channels 1 – 8 at the output of the D/A converters.

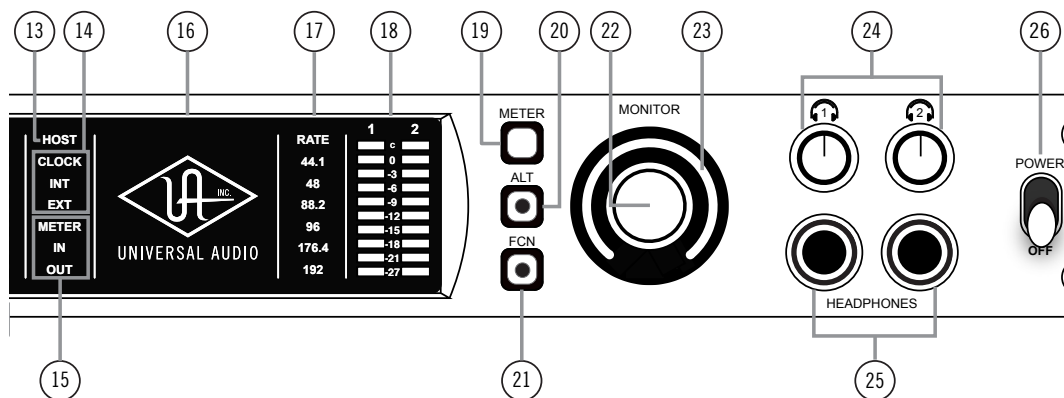

Apollo 8p front panel (right portion)

(13) HOST Indicator

The HOST indicator displays the status of the Thunderbolt connection to the host computer system. The possible states are:

Lit – The unit is communicating with the host computer and operating normally.

Unlit – The unit is starting up or it is not recognized by the host computer. Verify software installation and Thunderbolt connections.

Red – System error. Please contact technical support if the issue persists.

(14) CLOCK Indicators

Apollo 8p's clock source and status are displayed with these indicators. Either internal (INT) or external (EXT) is displayed. The clock source is set within the Console application; see the Apollo Software Manual for details.

Internal Clock

When Apollo 8p is set to internal clock, the INT indicator is illuminated white.

External Clock

Apollo 8p can use an external clock from the Word Clock, S/PDIF, or ADAT inputs. The EXT indicator has two possible states:

White – When set to external clock and a valid clock signal is detected at the specified port, the EXT indicator is illuminated white and Apollo 8p is synchronized to the external clock source.

Red – When set to external clock and a valid clock signal is NOT detected at the specified port, the EXT indicator is illuminated red and the internal clock remains active instead. In this situation, if/when the specified external clock becomes available, Apollo 8p switches back to the external clock, and the EXT indicator is illuminated and white.

Important: *When set to use any external clock source, Apollo 8p's sample rate must be manually set to match the sample rate of the external clock.*

(15) METER Indicators

These indicators show the current state of the Channel Level Meters (#12). The current state is changed with the METER switch (#19).

IN – When IN is illuminated, the channel meters display input signal levels.

OUT – When OUT is illuminated, the channel meters display output signals levels.

(16) Power Indicator (UA Logo)

The Universal Audio logo illuminates when the external power supply is properly connected to the AC outlet and the power input on the rear of the unit, and the Power switch (#26) is in the up position.

(17) Sample Rate Indicators

These indicators display the current sample rate setting for A/D and D/A conversion. The sample rate is set within the Console application or the host DAW; see the Apollo Software Manual for details.

(18) Monitor Output Level Meters

The 10-segment LED meters display the signal peak output levels of the rear panel Left & Right Monitor outputs at the output of the D/A converters. These meters are before the Monitor Level control (pre-fader) and reflect the D/A converter levels regardless of the current Monitor Level and Headphone Level knob settings.

The dB values of the monitor meter LEDs are indicated between the left and right channel meters. When digital clipping occurs, the red “C” (clip) LED illuminates.

If the monitor output level clips, reduce the monitor output level within the DAW and/or reduce the output level of individual channels feeding the monitor output bus within the Console application.

(19) Meter Switch

This switch determines whether the Channel Level Meters (#12) are displaying input levels or output signal levels. Pressing the switch toggles the state of the meters and the Meter Indicators (#15).

(20) Monitor ALT Switch

When ALT monitoring is configured in the Hardware panel within the Console Settings window (when ALT COUNT is set to a non-zero value), this switch toggles between the main monitor outputs and the ALT 1 outputs (line outputs 1 & 2).

When the ALT switch is engaged:

- The monitor signals are routed to outputs 1 & 2 instead of the main monitor outputs
- The orange LED within the switch is illuminated
- The Monitor Level Indicator (#23) is orange instead of green

For complete details about how to configure and use the ALT monitoring features, see the [Apollo Software Manual](#).

***Tip:** ALT 2 outputs (line outputs 3 & 4) can be selected with the FCN switch (#21, when configured in Console Settings) or in the Monitor column within the Console application.*

(21) Monitor Function Switch (FCN)

This is an assignable switch that can be configured to control one of three monitoring functions. The function of the switch is configured with the FCN SWITCH ASSIGN menu in the Hardware panel within the Console Settings window. See the Apollo Software Manual for details.

The amber LED within the switch flashes when the monitoring function is active. The function is toggled with the switch is pressed again. The available functions are:

ALT 2 – Selects the Alternate 2 monitor speakers. The monitor signals are routed to outputs 3 & 4 instead of the main monitor outputs, and the Monitor Level Indicator (#23) is amber instead of green when ALT 2 is active.

MONO – Sums the left and right channels of the stereo monitor mix into a monophonic signal. The Monitor Level Indicator (#23) flashes when MONO is active.

DIM – Attenuates the signal level at the monitor outputs by the dB amount set in the Control Room strip within the Console application. The Monitor Level Indicator (#23) flashes when DIM is active.

***Note:** When more than one Apollo interface is connected in a multi-unit configuration, the FCN switch is operable on the designated monitor unit only.*

(22) Monitor Level & Mute Knob

This rotary encoder serves two functions. Rotating the knob adjusts the monitor output level, and pressing the knob mutes the monitor outputs.

Monitor Level

Rotating the knob clockwise increases the signal level at the Left & Right Monitor Outputs on the rear panel. If ALT monitor outputs are configured and active, this knob controls the signal level at the ALT monitor's line outputs.

Although this is a digital control, the Left & Right Monitor Outputs volume is attenuated in the analog domain, after D/A conversion (digitally-controlled analog volume). This method provides the utmost monitoring fidelity, in contrast to digital volume controls that reduce levels by truncating the digital word length (aka “dropping bits”).

Monitor Output Gain Bypass

By default, monitor output levels are continuously variable. However, the monitor outputs can be set to completely bypass the monitor level circuitry and operate at a fixed reference level. This feature is set with the MONITOR OUTPUT GAIN menu in the Hardware panel within the Console Settings window.

***Tip:** This feature routes the signal directly from the D/A converters to the monitor outputs for the purest path when level control is not needed (for example, when connecting the monitor outputs to an external monitor controller).*

When the MONITOR OUTPUT GAIN menu is set to BYPASS in Console Settings:

- The Monitor Level Indicator ring (#23) is solid green
- When the Monitor knob (#22) is rotated, the ring flashes to indicate that no level adjustment is occurring
- ALT monitoring and assignable FCN switch features are unavailable
- Signals at the Monitor Outputs (#33) are output at line level (without attenuation)

Monitor Mute

Pressing the Monitor knob toggles the mute state of the signals at the Left & Right Monitor Outputs on the rear panel. If ALT monitoring is configured in the Hardware panel within the Console Settings window (when ALT COUNT is a non-zero value), the ALT monitor outputs are also muted by this control.

When the monitor outs are muted, the Monitor Level Indicator ring (#23) is red.

***Note:** Monitor Mute does not mute the headphone outputs.*

(23) Monitor Level & Monitor State Indicator

Tip: The Monitor Level and Monitor State indications are reflected in the Monitor column within the Console application.

Monitor Output Level Indicator

The relative signal level at the rear panel monitor outputs (and ALT monitor outputs, if configured) is indicated by the illuminated ring surrounding the Monitor Level knob.

This indicator is after the Monitor Level control (post fader). It indicates relative levels only and is not calibrated to specific dB values.

Monitor State Indicator

The color of the indicator ring indicates the current state of the monitor outputs:

Green (variable) – The main monitor outputs are active with variable level control

Green (fixed at maximum) – MONITOR OUTPUT GAIN is set to BYPASS in the Hardware panel within the Console Settings window

Red – The main monitor outputs (and ALT monitor outputs, if configured) are muted

Orange – The ALT 1 monitor outputs are active

Amber – The FCN switch is active and assigned ALT 2

Flashing – The monitor DIM and/or MONO functions are active

(24) Headphone Level Knobs 1 & 2

These knobs control the volume of Headphone Outputs 1 & 2 on the front panel. Each headphone output has its own volume control.

(25) Headphone Outputs 1 & 2

These ¼" stereo TRS phone jacks are for connecting stereo headphones to Apollo 8. Headphone outputs 1 & 2 are individually addressable.

By default, both headphone outputs mirror the monitor outputs. When mirroring the monitor outputs, the headphone outputs are unaffected by Monitor Mute (#18), to facilitate recording/tracking with headphones while the monitor speakers are muted.

Unique mixes can be created for each headphone output using the CUE functions within Console or by assigning mix buses from a DAW to the headphone outputs via the device drivers.

(26) Power Switch

This switch applies power to Apollo 8. When the unit is powered on, the Universal Audio logo (#16) is illuminated. The external power supply must be properly connected for this switch to function.

Rear Panel

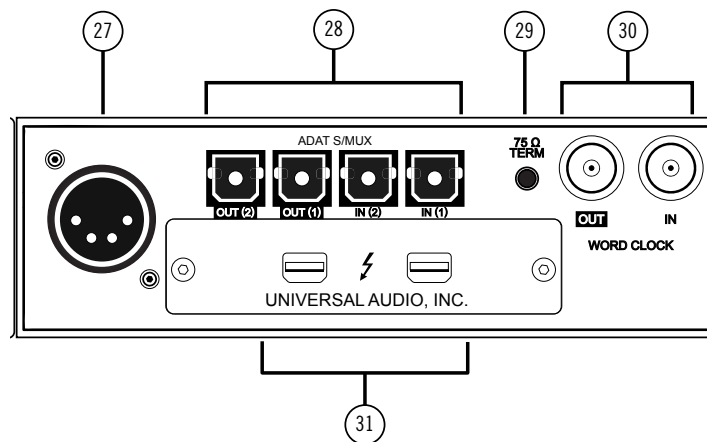

Apollo 8p rear panel (digital portion)

(27) Power Input

The included external power supply connects to this 4-pin locking XLR jack. Apollo 8p requires 12 volts DC power and draws approximately 50 Watts.

To eliminate risk of circuit damage, connect only the factory-supplied power supply. Use the Power switch on the front panel to power the unit on and off.

Important: Do not disconnect the power supply while Apollo 8p is in use, and confirm the Power switch is in the “off” position before connecting or disconnecting the power supply.

Digital I/O

(28) Optical I/O Ports

The optical ports can use either the ADAT or S/PDIF digital protocols for interconnecting with other audio hardware devices in the digital domain. Two optical inputs and two optical outputs are provided.

By default, the ADAT protocol is active for all optical ports. The protocol used by the optical input and output ports can be individually set in the Hardware panel within the Console Settings window. Each protocol is detailed below.

ADAT S/MUX Optical I/O

When set to ADAT, the optical ports use the ADAT Lightpipe Optical Interface protocol, routing a total of eight channels of digital audio. The channels routed by the ports depend on the current system sample rate.

At sample rates of 44.1 kHz and 48 kHz, the original ADAT protocol is used, and eight audio channels are routed on one ADAT port. At higher sample rates, industry standard S/MUX is used to maintain high-resolution transfers.

Important: *To utilize all eight channels with the optical ports at sample rates of 88.2 kHz and above, ADAT ports 1 & 2 must both be connected to the other device, and the other device must also support the ADAT S/MUX protocol.*

The following behaviors apply to the ADAT ports:

- At sample rates of 44.1 kHz and 48 kHz, port 1 supports eight channels of I/O. Output 2 mirrors output 1, and input 2 is disabled.
- At sample rates of 88.2 kHz and 96 kHz, up to four channels of audio are routed per port (eight channels total, when both ports are used).
- At sample rates of 176.4 kHz and 192 kHz, up to two channels of audio are routed per port (four channels total, when both ports are used). Only four ADAT channels are supported at 176.4 kHz and 192 kHz.

The ADAT port channel assignments described above are summarized in this table:

ADAT PORT CHANNEL ROUTING				
Sample Rate (kHz)	Input Port 1	Input Port 2	Output Port 1	Output Port 2
44.1 & 48	1 – 8	Disabled	1 – 8	1 – 8 (mirror of port 1)
88.2 & 96	1 – 4	5 – 8	1 – 4	5 – 8
176.2 & 192	1 – 2	3 – 4	1 – 2	3 – 4

S/PDIF Optical I/O

When set to S/PDIF, the optical ports use the S/PDIF protocol. The S/PDIF optical ports provide two channels of digital I/O with resolutions up to 24-bit at 96 kHz.

S/PDIF Sample Rate Conversion

Sample rate conversion can be performed on the S/PDIF input; this setting is enabled within the S/PDIF channel's input strip in the Console application. When the sample rate of the incoming S/PDIF signal does not match the sample rate specified in the Console application, the S/PDIF signal is converted to match Apollo 8p's sample rate. If Apollo 8p is set to use S/PDIF as the master clock source, sample rate conversion is inactive.

***Tip:** The S/PDIF output can be configured to mirror the Monitor Outputs (#33), for routing the stereo monitor signal to the stereo S/PDIF input of other devices. This feature is set with the DIGITAL MIRROR menu in the Hardware panel within the Console Settings window.*

(29) 75 Ohm Word Clock Termination Switch

This switch provides internal 75-ohm word clock input signal termination when required. Word clock termination is active when the switch is engaged (depressed).

Apollo 8p's termination switch should only be engaged when Apollo 8p is set to sync to external word clock and it is the last device at the receiving end of a word clock cable. For example, if Apollo 8p is the last "slave" unit at the end of a clock chain (when Apollo 8p's word clock out port is not used), termination should be active.

(30) Word Clock I/O

Word Clock In

Apollo 8p's internal clock can be synchronized (slaved) to an external master word clock. This is accomplished by setting Apollo 8p's clock source to Word Clock within the Console application, connecting the external word clock's BNC connector to Apollo 8p's word clock input, and setting the external device to transmit word clock. If Apollo 8p is the last device in the clock chain, the Termination switch (#10) should be engaged.

Important: *Apollo 8p's sample rate must be manually set to match the incoming clock's sample rate.*

Note: *Apollo 8p can be synchronized to an external "1x" clock signal only. Super-clock, overclocking, and subclocking are not supported.*

Word Clock Out

This BNC connector transmits a standard (1x) word clock when Apollo 8p is set to use its internal clock. The clock rate sent by this port matches the current system sample rate, as specified within the Console application.

When Apollo 8p is set to use external word clock as its clock, Apollo 8p is a word clock slave. If the incoming external word clock is within $\pm 0.5\%$ of a supported sample rate (44.1 kHz, 48 kHz, 88.2 kHz, 96 kHz, 176.4 kHz, 192 kHz), Word Clock Out will mirror Word Clock In with a slight phase delay (about 40ns).

Because Apollo 8p's word clock output is not a true mirror of the word clock input, word clock out should not be used to daisy chain the word clock if Apollo 8p is in the middle of the word clock chain. The correct method to connect Apollo 8p in the middle of a word clock chain is to use a T-connector at Apollo 8p's word clock input and leave Apollo 8p's word clock output unconnected (the Termination switch should not be engaged in this scenario).

(32) Thunderbolt 2 Ports

Apollo 8p has two Thunderbolt 2 ports. One port is used to connect Apollo 8p to a Thunderbolt 1 or Thunderbolt 2 port on the host computer. Thunderbolt peripheral devices may be serially connected (daisy-chained) to the second Thunderbolt port.

When Apollo 8p is properly communicating with the host computer via Thunderbolt, the HOST indicator (#13) illuminates.

Thunderbolt Bus Power

Per the Thunderbolt specification, bus power is supplied to downstream (daisy-chained) Thunderbolt peripheral devices. Apollo 8p must be powered on for the daisy-chained peripheral to receive Thunderbolt bus power.

Analog I/O

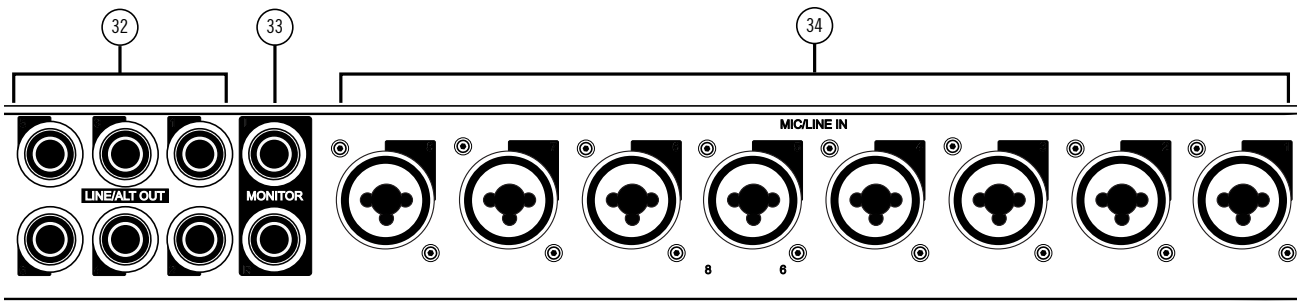

Apollo 8p rear panel (analog portion)

(32) Line Outputs 1 – 6

The individually addressable line-level analog outputs use balanced ¼" TRS phone jacks. Unbalanced ¼" TS cables can also be used.

The Line Outputs can be configured in adjacent pairs to use –10 dBV or +4 dBu reference levels. This function is configured in the Hardware panel within the Console Settings window.

ALT Outputs 1 – 4

Apollo 8p features ALT (alternate) monitoring capabilities. ALT monitoring can be used to control up to two alternate pairs of monitor speakers.

When ALT monitoring is enabled, the output level and muting of line outputs 1 & 2 (ALT 1) and 3 & 4 (ALT 2) are controlled by the Monitor Level & Mute knob (#22). ALT monitoring is enabled in the Hardware panel within the Console Settings window by increasing the ALT COUNT setting to a non-zero value.

Note: ALT monitoring features are unavailable when MONITOR OUTPUT GAIN is set to BYPASS. See [Monitor Output Gain Bypass](#) for related information.

(33) Left & Right Monitor Outputs

These balanced ¼” TRS phone jacks are line-level analog outputs typically used for connection to a stereo loudspeaker monitoring system. Unbalanced ¼” TS cables can also be used.

The signal levels and muting at these outputs are controlled with the Monitor Level & Mute knob (#22).

Note: If *MONITOR OUTPUT GAIN* is set to *BYPASS* in the Hardware panel within the Console Settings window, monitor signals are output at line level (without attenuation) and the Monitor Level knob does not control the Monitor or ALT output levels. See [Monitor Output Gain Bypass](#) for related information.

The Monitor Outputs are completely independent from the six Line Outputs (except when ALT monitoring is configured). By default, the “1–2” or “L–R” or “Main” outputs from a DAW are routed to these outputs (these labels vary within each particular DAW).

Tip: The S/PDIF output (#28) can be configured to mirror the Monitor Outputs, for routing the stereo monitor signal to the stereo S/PDIF input of other devices. This feature is set with the *DIGITAL MIRROR* menu in the Hardware panel within the Console Settings window.

(36) Mic/Line Inputs 1 – 8

Analog preamp inputs 1 – 8 use XLR/TRS combination jacks. XLR plugs are routed to the channel's microphone input, and TRS plugs are routed to the channel's line input.

Inputs 1 – 8 are switched between the XLR and Line connections using the front panel switch (#4) or the Console application.

Note: *The Hi-Z inputs override the Mic/Line inputs on channels 1 & 2.*

Adjacent inputs (1+2, 3+4, 5+6, 7+8) can be stereo linked via the front panel Link switch (#9) or the Console application.

XLR Inputs 1 – 8

The balanced Microphone inputs accept XLR plugs. Pin 2 is wired positive (hot).

+48V phantom power is available for the XLR inputs via the front panel switch (#6) or the Console application.

Caution: *To avoid potential equipment damage, disable +48V phantom power on the channel before connecting or disconnecting its XLR input.*

Line Inputs 1 – 8

Line Inputs 1 – 8 accept balanced ¼" TRS phone plugs. Unbalanced ¼" TS plugs can also be used.

Inputs 1 – 8 Gain

XLR Input Gain

The XLR mic inputs are always routed into the channel's microphone preamplifier. The gain is controlled by the PREAMP knob (#2) when the channel is selected, or the Console application. The mic preamps provide up to 65 dB of gain.

¼" Input Gain

Line inputs 1 – 8 can be individually routed into the channel's preamplifier for variable gain adjustments, or the preamp circuitry can be completely bypassed for the purest path directly into the A/D converter. This option is set with the LINE INPUT GAIN menu in the Hardware panel within the Console Settings window. By default, line inputs 1 – 8 are routed into the preamp.

When the preamps are bypassed, line inputs 1 – 8 operate at a fixed reference level of +4 dBu. When routed into the preamps, gain for line inputs 1 – 8 is continuously variable with up to 65 dB of available gain.

Note: *For related information, see [Line Input Gain Bypass](#).*

Interconnections

Installation Notes

- Apollo 8p may get hot during normal operation if it doesn't receive adequate airflow circulation around its chassis vents. For optimum results when mounting Apollo 8p in a rack, leaving at least one empty rack space above the unit to allow adequate airflow for cooling is recommended.
- As with any sound system, the following steps are recommended to avoid audio spikes in your speakers:
 1. Apply power to the speakers last, after all other devices (including Apollo 8p) are powered on.
 2. Turn off the speakers first, before all other devices (including Apollo 8p) are powered off.
 3. Remove headphones from ears before powering Apollo 8p on or off.

Thunderbolt Connections

- Apollo 8p must be connected directly to a Thunderbolt port on the host computer. The Apple Thunderbolt to FireWire Adapter cannot be used for the host computer connection.
- Connect only one Apollo 8p Thunderbolt port to the host computer. Thunderbolt is a bidirectional protocol.
- Apollo 8p cannot be bus powered via Thunderbolt. The included external power supply must be used.
- Thunderbolt bus power is supplied to downstream (daisy-chained) peripheral devices. Apollo 8p must be powered on for the daisy-chained peripheral to receive Thunderbolt bus power.

About Thunderbolt 2

- Apollo 8p is a Thunderbolt 2 device. Thunderbolt 2 technology is designed for backwards compatibility with Thunderbolt 1.
- Apollo 8p can be connected to Mac computers and other devices that have Thunderbolt 1 ports or Thunderbolt 2 ports.
- Apollo 8p can be connected to compatible Thunderbolt 3 equipped computers via a qualified Thunderbolt 3 to Thunderbolt adapter.

Apollo Expanded

- When more I/O and/or DSP is needed, up to four Apollo interfaces can be cascaded together via Thunderbolt in a multiple-unit configuration.
- For complete details about multi-unit cascading, refer to the Apollo Software Manual.

Basic Setup

This diagram illustrates a simple Apollo 8p setup that could be used by an individual musician/engineer for recording and mixing. It shows an electric guitar connected to the Hi-Z input of channel 1 and a microphone connected to the XLR input of channel 2 so they can both be recorded simultaneously.

Key points for this example:

- Two preamp channels are used (electric guitar and microphone)
- Mic/Line switch for channel 2 is set to MIC
- Monitor outputs are connected to powered monitors (or an amp+speaker system)

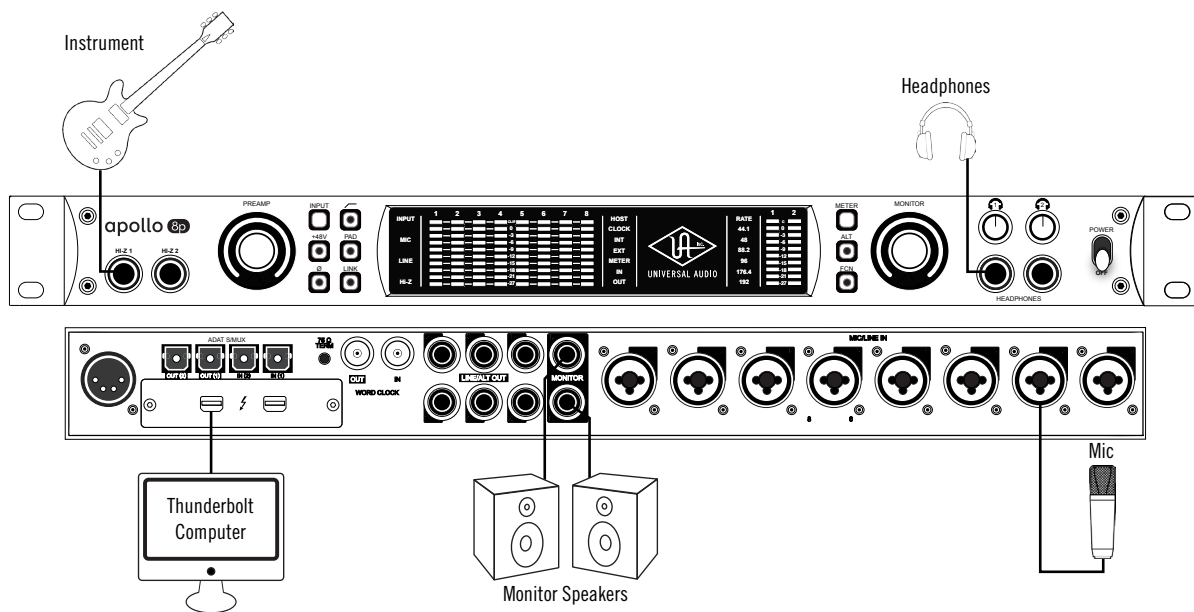

Typical Setup

This diagram illustrates an Apollo 8p setup that could be used to record two musicians simultaneously. In this setup, only analog devices are connected; digital I/O is not used.

The example shows an electric guitar and electric bass connected to the Hi-Z inputs. Microphones are connected to XLR inputs of channel 3 and 4, and a stereo keyboard is connected to line inputs 5 and 6. Both headphone outputs are used during tracking and the left/right monitor outputs are connected to a loudspeaker system for mixdown.

Key points for this example:

- Mic/Line switches for channels 3 and 4 are set to MIC
- Unique mixes can be crafted via the CUE sends and routed to each headphone output for “more me” during tracking

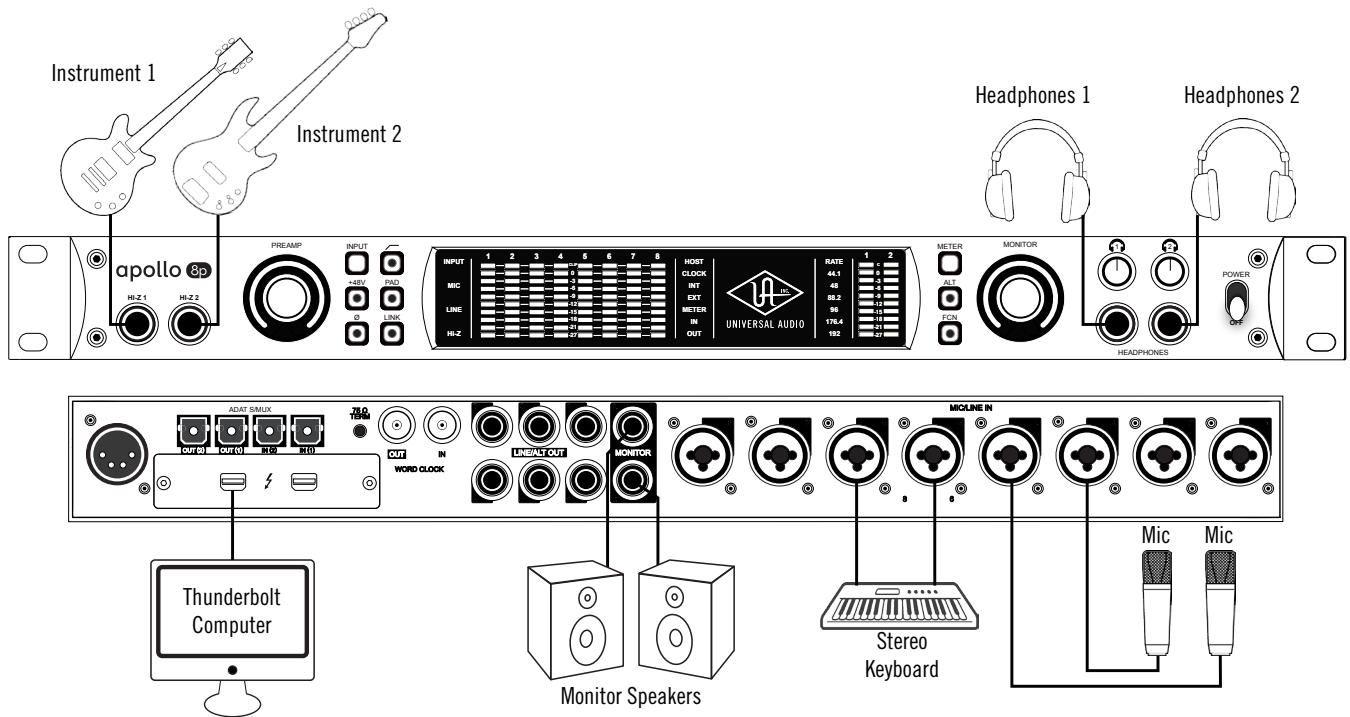

Advanced Setup

This diagram illustrates a more complex Apollo 8p setup that could be used for recording an entire ensemble, utilizing both analog and digital I/O.

In addition to the connections in the previous example, four additional microphones are connected to Universal Audio's 4-710d Four-Channel Tone-Blending Mic Preamp w/Dynamics. The 4-710d performs A/D conversion on these mics and the signals are digitally routed into Apollo via the ADAT optical interface. Apollo 8p is the master clock source, so the 4-710d is set to use external word clock (and a 75-ohm BNC word clock cable is interconnected). ALT monitors are configured for comparing different speakers.

A stereo digital recorder is connected to the S/PDIF output, a tuner is connected to analog line output 8, and a Thunderbolt hard drive is daisy-chained off Apollo 8p.

Key points for this example:

- Mic/Line switch for channels 3 and 4 are set to MIC
- Four additional mic preamps from UA's 4-710d are routed into Apollo 8p via ADAT Lightpipe
- Apollo 8p is the master clock device; the 4-710d clock source is set to external word clock and the 4-710d Termination switch is engaged (alternately, the 4-710d could be used as the master clock by setting the 4-710d to internal clock, setting Apollo to external ADAT clock, and eliminating the word clock cable)

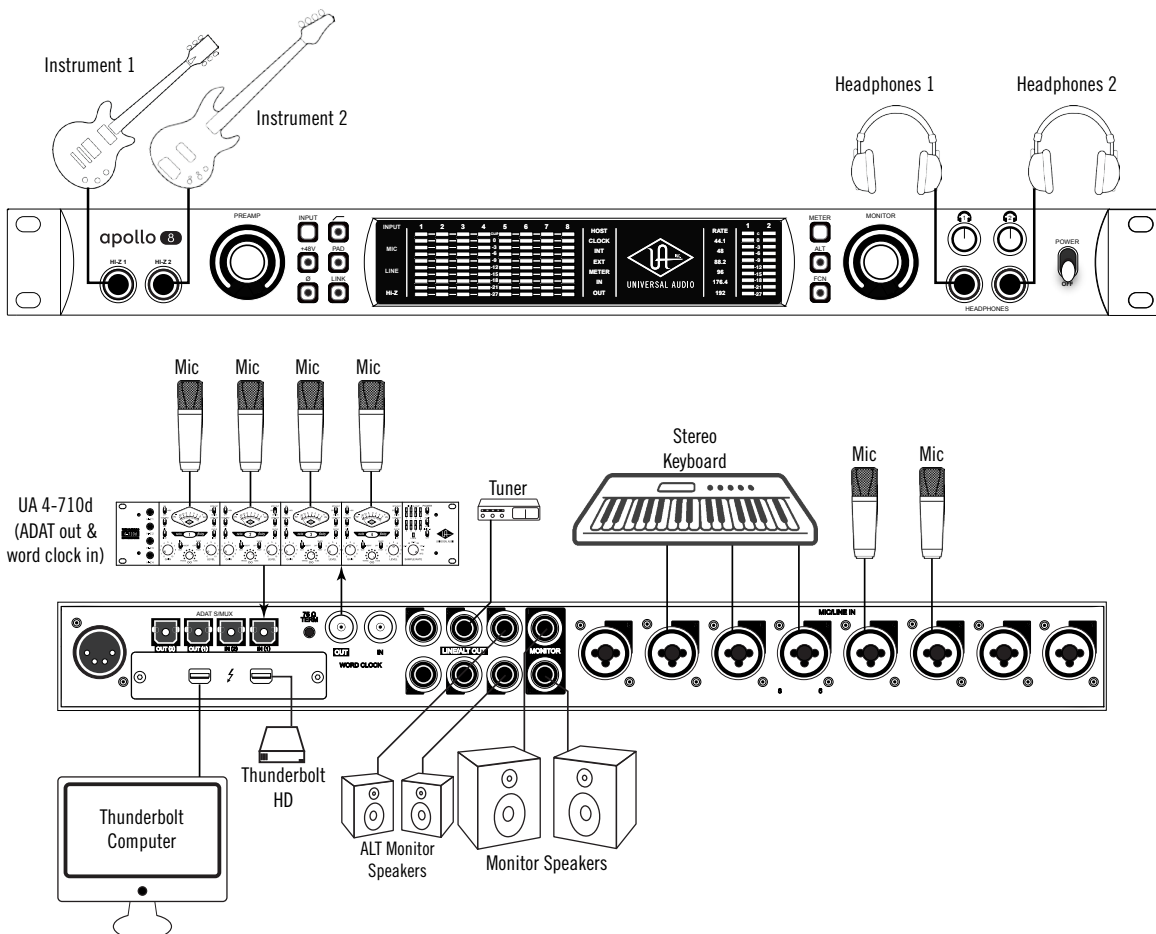

Apollo Expanded: Multi-Unit Wiring

The diagram below illustrates how to interconnect multiple Apollo units and the host computer via Thunderbolt.

Important: For complete details about system operation when multi-unit cascading, see the [Apollo Software Manual](#).

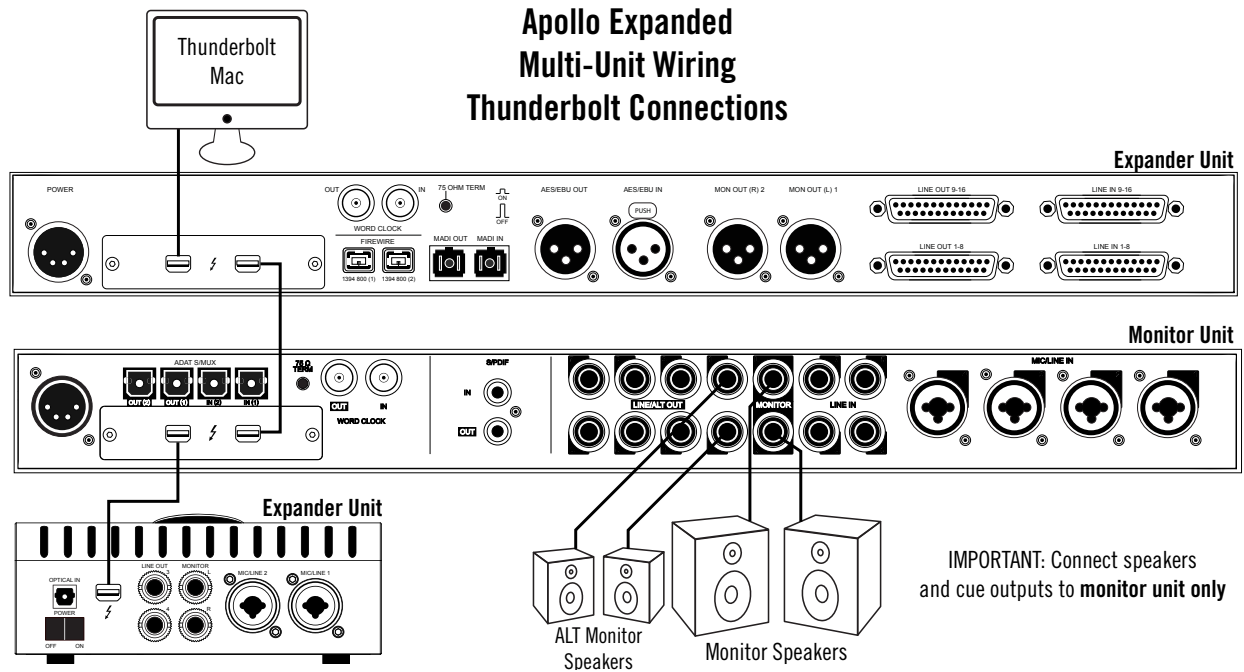

Cables Required

- One Thunderbolt cable for each Apollo unit

Note: All Apollo rack units require Thunderbolt connections (FireWire cannot be used).

Apollo Expanded Wiring Notes

- A single Thunderbolt cable is required for all Apollo unit interconnections. Connect one cable to the host computer and one cable between Apollo units.
- Thunderbolt 1 or 2 ports may be mixed and used for any/all connections.
- The computer and all Apollo units must be connected to the same Thunderbolt bus.
- The Apollo device ordering and the Thunderbolt ports used (second port on Apollo vs. second port on computer, placement in daisy chain, etc) is not important.
- In this wiring example diagram, the Apollo 8 in the center is the designated monitor (master) unit. Connect speakers (including ALT speakers) and any cue outputs to the monitor unit only.
- Do not connect more than one Thunderbolt cable between the same two devices (the Thunderbolt protocol is bidirectional).
- Do not interconnect any Word Clock, FireWire, ADAT, or MADI ports between any Apollo units.

Software Setup

***Note:** Items on this page are detailed in the [Apollo Software Manual](#). See the [Apollo 8p Documentation Overview](#) for related information.*

System Requirements

All system requirements must be met for Apollo 8p to operate properly. Before proceeding with installation, see the system requirements in the Apollo Software Manual.

Software Installation

The software must be installed to use the hardware and UAD plug-ins. The UAD Powered Plug-Ins software installer contains the Apollo 8p software and drivers.

***Note:** For optimum results, connect and power Apollo 8p before installing the software.*

To obtain the latest UAD Powered Plug-Ins software installer, visit:

- www.uaudio.com/downloads

Registration and Authorization

Apollo 8p must be registered and authorized to unlock UAD plug-ins that are bundled with the product. Registration and authorization via a web browser is triggered automatically by the UAD software the first time the device is connected.

System Configuration

Complete details about setting up the Apollo 8p system, including how to integrate with a DAW and related information, are included in the Apollo Software Manual.

Console Application

The included Console application is the software interface for the Apollo 8p hardware. Console controls Apollo 8p and its digital mixing, monitoring, and Realtime UAD Processing features. Console is also used to configure Apollo 8p's I/O settings such as sample rate, clock source, and reference levels.

For complete details about how to operate Console, refer to the Apollo Software Manual.

UA Support Videos

Informational videos are available online to help you get started with Apollo 8p:

- help.uaudio.com

Specifications

All specifications are typical performance unless otherwise noted, tested under the following conditions: 48 kHz internal sample rate, 24-bit sample depth, 20 kHz measurement bandwidth, with balanced output.

SYSTEM	
<i>I/O Complement</i>	
Microphone Inputs	Eight
High-Impedance (Hi-Z) Instrument Inputs	Two
Analog Line Inputs	Eight
Analog Line Outputs	Six (eight including monitor outputs)
Analog Monitor Outputs	Two (one stereo pair)
Headphone Outputs	Two stereo
Digital Input Ports (TOSLINK optical)	Two (ADAT or S/PDIF, selectable)
Digital Output Ports (TOSLINK optical)	Two (ADAT or S/PDIF, selectable)
Thunderbolt 2 ports	Two (Thunderbolt 1 compatible)
Word Clock	One input, one output
<i>A/D – D/A Conversion</i>	
Supported Sample Rates (kHz)	44.1, 48, 88.2, 96, 176.4, 192
Bit Depth Per Sample	24
Simultaneous A/D conversion	Eight channels
Simultaneous D/A conversion	14 channels
Analog Round-Trip Latency	1.1 milliseconds @ 96 kHz sample rate
Analog Round-Trip Latency with up to four serial UAD plug-ins via Console application	1.1 milliseconds @ 96 kHz sample rate

(continued)

ANALOG I/O	
Frequency Response	20 Hz – 20 kHz, ±0.1 dB
Microphone Inputs 1 – 8	
Connector Type	XLR Female, pin 2 positive (Combo XLR/TRS)
Phantom Power	+48V (switchable per mic input)
Dynamic Range	119 dB (A-weighting)
Signal-to-Noise Ratio	119 dB (A-weighting)
Total Harmonic Distortion + Noise	-110 dBFS
Equivalent Input Noise	-128.7 dB
Common-Mode Rejection Ratio (CMRR)	70 dB (10' cable)
Default Input Impedance	5.4K Ohms (variable via Unison plug-ins)
Gain Range	+10 dB to +65 dB
Pad Attenuation	20 dB (switchable per input)
Maximum Input Level	+25 dBu (minimum gain, pad engaged)
Hi-Z Inputs 1 – 2	
Connector Type	¼" Female TS Unbalanced
Dynamic Range	118 dB (A-weighting)
Signal-to-Noise Ratio	118 dB (A-weighting)
Total Harmonic Distortion + Noise	-103 dBFS
Input Impedance	1M Ohms (variable via Unison plug-ins)
Gain Range	+10 dB to +65 dB
Maximum Input Level	+12 dBu
Line Inputs 1 – 8	
Connector Type	¼" Female TRS Balanced (Combo XLR/TRS)
Dynamic Range	120 dB (A-weighting)
Signal-to-Noise Ratio	120 dB (A-weighting)
Total Harmonic Distortion + Noise	-110 dBFS
Common-Mode Rejection Ratio (CMRR)	60 dB (10' cable)
Input Impedance	10K Ohms
Gain Range	+10 dB to +65 dB (Line Input Gain = ON)
Reference Level	+4 dBu (Line Input Gain = BYPASS)
Maximum Input Level	+20.2 dBu

(continued)

ANALOG I/O*(continued)***Line Outputs 1 – 6**

Connector Type	¼" Female TRS Balanced
Dynamic Range	121 dB (A-weighting)
Signal-to-Noise Ratio	121 dB (A-weighting)
Total Harmonic Distortion + Noise	-110 dBFS
Stereo Level Balance	±0.05 dB
Output Impedance	100 Ohms
Maximum Output Level	+20.2 dBu

Monitor Outputs Left & Right

Connector Type	¼" Female TRS Balanced
Dynamic Range	121 dB (A-weighting)
Signal-to-Noise Ratio	121 dB (A-weighting)
Total Harmonic Distortion + Noise	-110 dBFS
Stereo Level Balance	±0.01 dB
Output Impedance	100 Ohms
Maximum Output Level	+20.2 dBu

Stereo Headphone Outputs 1 – 2

Connector Type	¼" Female TRS Stereo
Dynamic Range	118 dB (A-weighting)
Signal-to-Noise Ratio	118 dB (A-weighting)
Total Harmonic Distortion + Noise	-101 dBFS
Maximum Output Power	160 mW into 300 ohm load

(continued)

DIGITAL I/O	
<i>S/PDIF</i>	
Connector Type (shared with ADAT)	Optical TOSLINK JIS F05
Format	IEC958
Supported Sample Rates (kHz)	44.1, 48, 88.2, 96
<i>ADAT</i>	
Connector Type (shared with S/PDIF)	Optical TOSLINK JIS F05
Format	ADAT Digital Lightpipe with S/MUX
Supported Sample Rates (kHz)	44.1, 48, 88.2, 96, 176.4, 192
Channel Assignments @ 44.1 kHz, 48 kHz	Port 1 = Channels 1 – 8, Port 2 = 1 – 8 (mirrored)
Channel Assignments @ 88.2 kHz, 96 kHz	Port 1 = Channels 1 – 4, Port 2 = Channels 5 – 8
Channel Assignments @ 176.4 kHz, 192 kHz	Port 1 = Channels 1 – 2, Port 2 = Channels 3 – 4
<i>Word Clock</i>	
Connector Type	BNC
Lock Range	±0.5% of any supported sample rate
Word Clock Input Termination	75 Ohms, switchable
<i>Synchronization Sources</i>	
Internal, Word Clock, S/PDIF, ADAT	
Electrical	
Power Supply	External AC to DC Power Supply, Level V compliant
AC Input Connector Type	IEC Male
AC Requirements	100V – 240V AC, 50 – 60 Hz
DC Connector Type	XLR 4-Pin Locking Male (Neutrik P/N NC4MDM3-H)
DC Requirements	12 VDC, ±5%
Maximum Power Consumption	50 Watts
Mechanical	
<i>Dimensions</i>	
Width	19"
Height	1.75" (1U rack space)
Depth, Chassis Only	12.125"
Depth, Including Knob & Jack Protrusions	13.5"
Shipping Box (Width x Depth x Height)	24" x 17" x 8"
<i>Weight</i>	
Shipping Weight (with box & accessories)	18 pounds
Weight (bare unit)	9.1 pounds
<i>Package Contents</i>	
Apollo 8p Audio Interface Unit	
External Power Supply	
AC Power Cable (IEC)	
Set of (4) Rack-Mount Screws	
Getting Started URL Card	

Block Diagram

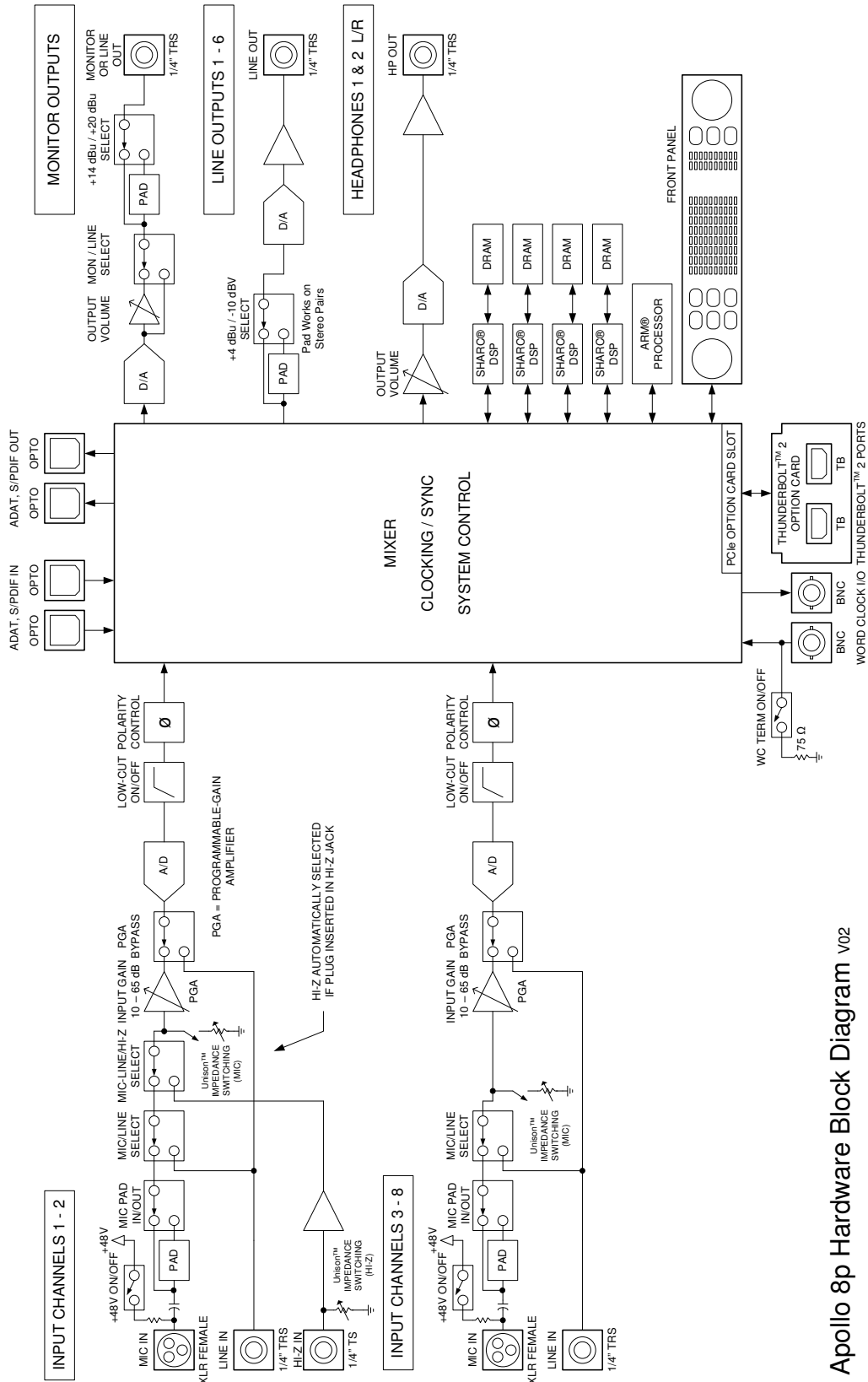

Apollo 8p Hardware Block Diagram v02

Troubleshooting

If Apollo 8p isn't behaving as expected, here are some common troubleshooting items to confirm. If you are still experiencing issues after performing these checks, contact [Technical Support](#).

SYMPTOM	ITEMS TO CHECK
Unit won't power on	<ul style="list-style-type: none"> • Confirm power supply connections at power supply input and back of unit • Confirm Power switch is not in "OFF" position • Confirm AC power is available at wall socket by plugging in a different device
No monitor output	<ul style="list-style-type: none"> • Confirm connections, power, and volume of monitoring system • Confirm monitor knob is turned up • Confirm monitor outputs are not muted (push monitor knob) • Confirm monitor LEDs are active (check signal flows)
Can't hear channels 1 – 8	<ul style="list-style-type: none"> • Confirm preamp gain is turned up for the channel(s)
Can't hear mic or line input(s)	<ul style="list-style-type: none"> • Confirm mic/line switch setting is correct for the channel • Confirm nothing is plugged into the channel's Hi-Z input
Can't hear Hi-Z input(s)	<ul style="list-style-type: none"> • Confirm volume on connected device is turned up • Confirm Hi-Z input cable is 1/4" TS only (not TRS)
Can't hear mic input(s)	<ul style="list-style-type: none"> • Confirm +48V phantom power is enabled (if required by microphone)
Preamp controls have no effect on channel	<ul style="list-style-type: none"> • Confirm desired channel is selected for control (push PREAMP knob to select)
Can only adjust input channels 1 – 8	<ul style="list-style-type: none"> • Signal levels for digital inputs are adjusted at the device connected to those inputs
Audio glitches and/or dropouts during playback	<ul style="list-style-type: none"> • Increase audio buffer size setting • Confirm clocking setups (check cable connections and confirm all device clocks are synchronized to one master clock device)
Undesirable echo/phasing	<ul style="list-style-type: none"> • Confirm input monitoring is not enabled in both Console and DAW
HOST indicator is unlit or red	<ul style="list-style-type: none"> • Confirm Thunderbolt connections • Confirm Apollo software is installed • Power Apollo off then on, and restart computer • Reinstall Apollo software • Try a Thunderbolt cable
Static and/or white noise is heard when nothing is plugged in	<ul style="list-style-type: none"> • Mute or lower preamp gain to minimum on all unused preamp channels (mic preamps can emit noise even when nothing is plugged in) • Some UAD plug-ins model the noise characteristics of the original equipment. Defeat the noise model in the UAD plug-in GUI, or mute the channel containing the plug-in to temporarily mute the noise
Various LEDs inside the unit are blinking	<ul style="list-style-type: none"> • This is normal operational behavior that can be safely ignored
Apollo 8p is behaving unexpectedly	<ul style="list-style-type: none"> • As a last resort, perform a hardware reset on the unit by following these steps: <ol style="list-style-type: none"> 1. Power off Apollo 2. Press and hold the PREAMP, LOW CUT, and POLARITY controls 3. Power on Apollo 8p while continuing to hold all three controls 4. After all front panel LEDs flash rapidly (after several seconds), release the controls

Notices

Important Safety Information

Before using this unit, be sure to carefully read the applicable items of these operating instructions and the safety suggestions. Afterwards, keep them handy for future reference. Take special care to follow the warnings indicated on the unit, as well as in the operating instructions.

Water and Moisture – Do not use the unit near any source of water or in excessively moist environments.

Object and Liquid Entry – Care should be taken so that objects do not fall, and liquids are not spilled, into the enclosure through openings.

Ventilation – When installing the unit in a rack or any other location, be sure there is adequate ventilation. Improper ventilation will cause overheating, and can damage the unit.

Heat – The unit should be situated away from heat sources, or other equipment that produces excessive heat.

Power Sources – The unit should be connected to a power supply only of the type described in the operating instructions, or as marked on the unit.

Power Cord Protection – AC power supply cords should be routed so that they are not likely to be walked on or pinched by items placed upon or against them. Pay particular attention to cords at plugs, convenience receptacles, and the point where they exit from the unit. Never take hold of the plug or cord if your hand is wet. Always grasp the plug body when connecting or disconnecting it.

Cleaning – Follow these general rules when cleaning the outside of the unit:

- a. Turn the power off and unplug the unit
- b. Gently wipe with a clean lint-free cloth
- c. Do not use aerosol sprays, solvents, or abrasives

Nonuse Periods – The AC power supply cord of the unit should be unplugged from the AC outlet when left unused for a long period of time.

Damage Requiring Service – The unit should be serviced by a qualified service personnel when:

- a. The AC power supply unit has been damaged; or
- b. Objects have fallen or liquid has been spilled into the unit; or
- c. The unit has been exposed to rain; or
- d. The unit does not operate normally or exhibits a marked change in performance; or
- e. The unit has been dropped, or the enclosure damaged.

Servicing – The user should not attempt to service the unit beyond that described in the operating instructions. All other servicing should be referred to qualified service personnel.

Warranty

Universal Audio provides a warranty on all hardware products. To learn more, please visit www.uaudio.com/support/warranty.html or contact [Technical Support](#). This limited warranty gives you specific legal rights. You may also have other rights which vary by state or country.

Maintenance

Apollo 8p does not contain a fuse or any other user-replaceable parts. The unit is internally calibrated at the factory. No internal user adjustments are available.

Repair Service

If you are having trouble with Apollo 8p, the first check all system setups, connections, software installations, and the [Troubleshooting](#) chart. If that doesn't help, contact [Technical Support](#). To learn more about repair service, please visit:

- www.uaudio.com/support/rma-faq.html

FCC Compliance

Federal Communications Commission United States Class A Manual Statement

Note: This equipment has been tested and found to comply with the limits for a Class A digital device pursuant to Part 15 of the FCC Rules. These limits are designed to provide reasonable protection against harmful interference when the equipment is operated in a commercial environment. This equipment generates, uses, and can radiated radio frequency energy and, if not installed and used in accordance with the instruction manual, may cause harmful interference to radio communications. Operation of this equipment in a residential area is likely to cause harmful interference in which case the user will be required to correct the interference at his own expense.

Any modifications to the unit, unless expressly approved by Universal Audio, could void the User's authority to operate the equipment.

Disclaimer

The information contained in this manual is subject to change without notice. Universal Audio, Inc. makes no warranties of any kind with regard to this manual, including, but not limited to, the implied warranties of merchantability and fitness for a particular purpose. Universal Audio, Inc. shall not be liable for errors contained herein or direct, indirect, special, incidental, or consequential damages in connection with the furnishing, performance, or use of this material.

End User License Agreement

Your rights to the Software are governed by the accompanying End User License Agreement, a copy of which can be found at: www.uaudio.com/eula

Trademarks

Universal Audio, the Universal Audio “diamond” logo, Apollo, Apollo Twin, Apollo 16, Unison technology, UAD, UAD Series, UAD-1, UAD-2, UAD-2 Satellite, Powered Plug-Ins, 1176LN, 1176SE, Teletronix, LA-2A, LA-3A, LA-610, LA-610MkII, 2-1176, 2-610, 6176, 710 Twin-Finity, 2192, 4-710d, Cambridge EQ, DreamVerb, Plate 140, Precision Limiter, RealVerb Pro, Precision Buss Compressor, Precision De-Esser, Precision Maximizer, and “Analog Ears | Digital Minds,” are among the trademarks, trade names, and service marks owned by UA that may appear on the Site, many of which are registered in the United States and other countries. This is not a comprehensive list of all UA trademarks. All UA trademarks inure to the benefit of UA. Other trademarks and trade names that may appear on the Site and which are not owned by UA are owned by the respective owners.

Copyright

Copyright ©2017 Universal Audio, Inc. All rights reserved.

This manual and any associated software, artwork, product designs, and design concepts are subject to copyright protection. No part of this document may be reproduced, in any form, without prior written permission of Universal Audio, Inc.

Technical Support

Universal Audio Knowledge Base

The UA Knowledge Base is your complete technical resource for configuring, operating, and troubleshooting UA products.

You can watch helpful support videos, search the Knowledge Base for answers, find updated technical information that may not be available in other publications, and more.

- help.uaudio.com

YouTube Support Channel

The Universal Audio Support Channel at youtube.com includes helpful support videos for setting up and using UA products.

- [Universal Audio YouTube Support Channel](#)

UAD Community Forums

The unofficial UAD discussion forums are a valuable resource for all Universal Audio product users. This website is independently owned and operated.

- www.uadforum.com

Contact UA Support

Universal Audio provides free technical support to registered product owners. Support specialists are available to answer technical inquiries via email and telephone.

- help.uaudio.com

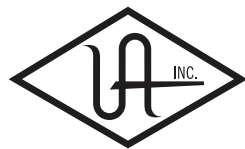

UNIVERSAL AUDIO