

# Laney

## CD1042S 2 x 200 W POWERED MIXER

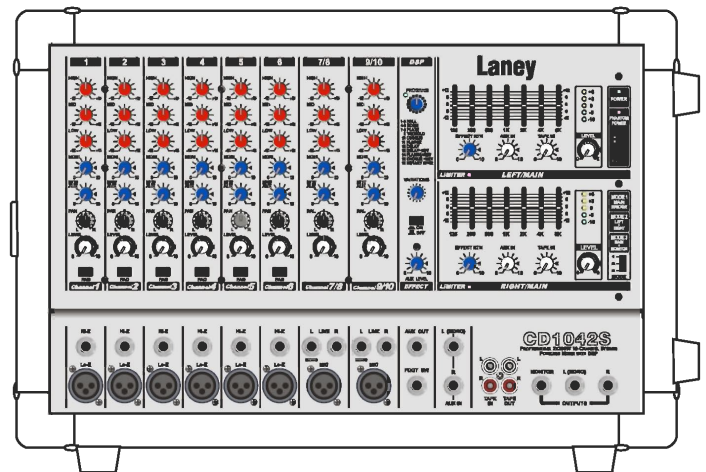

[www.laney.co.uk](http://www.laney.co.uk)

## User's Manual

In the interest of on going product development Laney reserves the right to amend specifications without prior notification

Revision 1.1

## 2 Important



Intended to alert the user to the presence of uninstalled "dangerous voltage" within the product's enclosure that may be of sufficient magnitude to constitute a risk of electric shock to persons.



Intended to alert the user of the presence of important operating and maintenance (servicing) instructions in the literature accompanying the product.

**Caution:** Risk of electrical shock - DO NOT OPEN!

**Caution:** To reduce the risk of electrical shock, do not remove cover. No user serviceable parts inside. Refer servicing to qualified service personnel.

**Warning:** This apparatus must be earthed

**WARNING:** To prevent electrical shock or fire hazard, do not expose this appliance to rain or moisture. Before using this appliance, read the operating guide for further warnings.

**EMC warning**  
It is inherent in the design of a loudspeaker and in the design of guitar pickups that they should emit or be affected by electro magnetic fields. Loudspeaker enclosures should not be used less than two meters away from equipment, which is likely to be affected by electro magnetic interference.  
Likewise, guitar fitted with electro magnetic pickups should not be used less than two meters away from any source of emissions such as loudspeakers. Emissions from loudspeakers are dependent on the frequency characteristics of the drive unit. Levels were measured direct from the driver of 30 dBuV. These levels are reduced to a safe level at a distance of 1.27 meters from the drivers.

### IMPORTANT SAFETY INSTRUCTIONS

**WARNING:** When using electric products, basic cautions should always be followed, including the following.

1. Read all safety and operating instructions before using this product
2. All safety and operating instructions should be retained for future reference
3. Obey all cautions in the Operating instructions and on the back of the unit
4. All operating instructions should be followed
5. This product should not be used near water, i.e. a bathtub, sink, swimming pool, wet basement, etc.
6. This product should be located so that its position does not interfere with its proper ventilation. It should not be placed flat against a wall or placed in a built up enclosure that will impede the flow of cooling air.
7. This product should not be placed near a source of heat such as stove, radiator, or another heat producing amplifier.
8. Connect only to a power supply of the type marker on the unit adjacent to the power supply cord.
9. Never break off the ground pin on a power supply cord.
10. Power supply cords should always be handled carefully. Never walk or place equipment on power supply cords. Periodically check cords for cuts or signs of stress, especially at the plug and the point where the cord exits the unit.
11. The power supply cord should be unplugged when the unit is not in use and during lightning storms.
12. If this product is to be mounted in an equipment rack, rear support should be provided.
13. Metal parts can be cleaned with a damp cloth. The vinyl covering used on some units can be cleaned with a damp cloth or ammonia based household cleaner if necessary. Disconnect the unit from the power supply before cleaning.
14. Care should be taken so that objects do not fall and liquids are not spilled into the unit through any ventilation holes or openings. CAUTION - on no account place drinks on the unit.
15. A qualified service technician should check the unit if:
  - The power cord has been damaged
  - Anything has fallen or spilled into the unit
  - The unit does not appear to operate correctly
  - The unit has been dropped or the enclosure damaged.
16. The user should not attempt to service the equipment. All service work is done by a qualified service technician.
17. Exposure to extremely high noise levels may cause a permanent hearing loss. Individuals very considerably in susceptibility to noise induced hearing loss, but nearly everyone will lose some hearing if exposed to sufficiently intense noise for a sufficient time. The U.S. Government's Occupational Safety and Health Administration (OSHA) has specified the following permissible noise level exposure.

Duration Per Day In Hours	Sound Level dBA, slow response
8	90
6	92
4	95
3	97
2	100
1 ½	102
1	105
½	110
¼ or less	115

According to OSHA, any exposure in excess of the above permissible limits could result in some hearing loss. Ear plugs or protectors in the ear canals or over the ears must be worn when operating this amplification system in order to prevent a permanent hearing loss if exposure exceeds the limits set forth above. To ensure against potentially dangerous exposure to high sound pressure levels it is recommended that all persons exposed to equipment capable of producing high sound pressure levels such as this amplification system be protected by hearing protectors while this unit is in operation.

## ■ Block Diagram

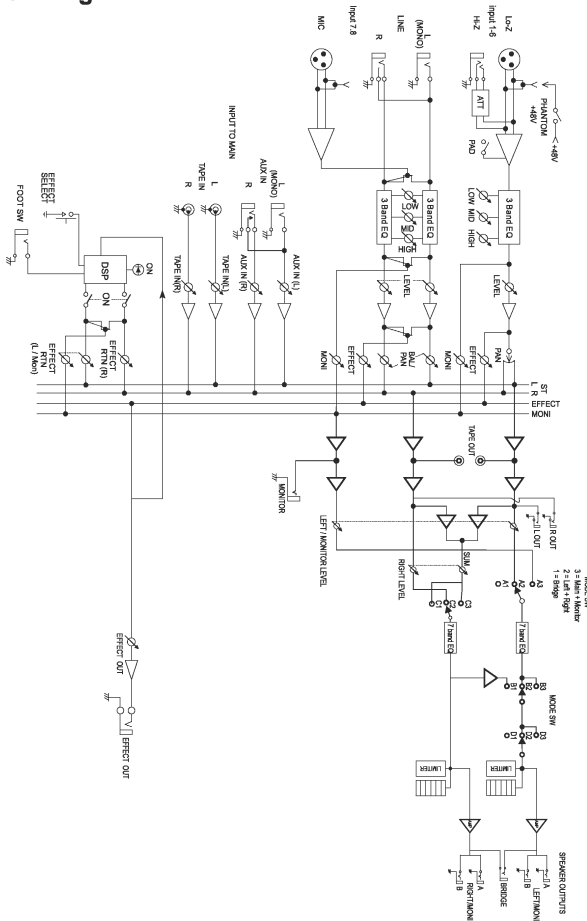

## Important

### Read the Following Before operating the CD1042S

#### Warnings

- \* Connect this unit's power cord only to an AC outlet of the type stated in this Owner's Manual or as marked on the unit. Failure to do so is a fire and electrical shock hazard.
- \* Do not allow water to enter this unit or allow the unit to become wet. Fire or electrical shock may result.
- \* Do not scratch, bend, twist, pull, or heat the power cord. A damaged power cord is a fire and electrical shock hazard.
- \* Do not place heavy objects, including this unit, on top of the power cord. A damaged power cord is a fire and electrical shock hazard. In particular, be careful not to place heavy objects on a power cord covered by a carpet.
- \* If you notice any abnormality, such as smoke, odor, or noise, or if a foreign object or liquid gets inside the unit, turn it off immediately. Remove the power cord from the AC outlet. Consult your dealer for repair. Using the unit in this condition is a fire and electrical shock hazard.
- \* Should this unit be dropped or the cabinet be damaged, turn the power switch off, remove the power plug from the AC outlet, and contact your dealer. If you continue using the unit without heeding this instruction, fire or electrical shock may result.
- \* If the power cord is damaged (i.e., cut or a bare wire is exposed), ask your dealer for a replacement. Using the unit with a damaged power cord is a fire and electrical shock hazard.
- \* Do not remove the unit's cover. You could receive an electrical shock. If you think internal inspection, maintenance, or repair is necessary, contact your dealer.
- \* Do not modify the unit. Doing so is a fire and electrical shock hazard.

#### Cautions

- \* Allow enough free space around the unit for normal ventilation. This should be: 20 cm at the sides, 40 cm behind, and 40 cm above. These distances should also be adopted when rack-mounting the unit. For normal ventilation during use, remove the rear of the rack or open a ventilation hole. If the airflow is not adequate, the unit will heat up inside and may cause a fire.
- \* This unit has ventilation holes at the front, rear and sides to prevent the internal temperature rising too high. Do not block them. Blocked ventilation holes are a fire hazard.
- \* Clean the contacts of the phone plug before connecting it to the SPEAKERS jack of this unit. Dirty contacts may generate heat.
- \* Use only speaker cables when connecting speakers to amplifier outputs. Using other types of cables is a fire hazard.
- \* Hold the power cord plug when disconnecting it from an AC outlet. Never pull the cord. A damaged power cord is a potential fire and electrical shock hazard.
- \* Do not touch the power plug with wet hands. Doing so is a potential electrical shock hazard.

#### Operating Notes

- \* The digital circuits of this unit may induce a slight noise into nearby radios and TVs. If noise occurs, relocate the affected equipment.
- \* Using a mobile telephone near this unit may induce noise. If noise occurs, use the telephone away from the unit.
- \* XLR-type connectors are wired as follows:  
pin 1: ground, pin 2: hot (+), and pin 3: cold (-).
- \* Do not set all equalizer controls and faders to maximum. Doing so may cause oscillation depending on the condition of the connected unit and speakers, and may damage the speakers.
- \* The performance of components with moving contacts, such as switches, rotary controls, faders, and connectors, deteriorates over time. The rate of deterioration depends on the operating environment and is unavoidable. Consult your dealer about replacing defective components.

## Introduction

Thank you for purchasing the CD1042S Powered Mixer.

In order to take full advantage of the CD1042S and enjoy long and trouble-free Performance, please read this owner's manual carefully, and keep it in a safe place for future reference.

## Features

- \* The CD1042S features ten input channels that support a wide range of audio sources, from microphones to line-level devices. The microphone input for each channel has a +48V phantom powering for use with condenser-type microphones.
- \* A built-in independent two powerful main power amplifiers 200W x 2 (200W+200W----total 400W monaureal in bridge connection), is capable of driving stereo main speakers or monitoring speakers on stage simultaneously in a sophisticated PA system environment.
- \* Individual seven-band graphic equalizers are provided to the main or the monitor sections. In this way, you can individually adjust the volume level and frequency response of the main speakers or monitor speakers.
- \* Two limiter circuits are built-in to prevent excessive input levels to the amplifiers.
- \* A digital effect with sixteen selectable effect types is built-in. A variety of effects can be applied to add reverberation or ambience to vocals or instrumental sounds.

## Contents

Front and rear panel .....	6
Control panel .....	6
Input/output panel .....	10
Rear panel .....	12
Connections .....	13
Basic Operation .....	15
Connecting microphones and Instruments .....	15
Sending an independent mix to the monitor speakers .....	15
Using the digital effect .....	15
Example setups .....	16
As a conference PA system/ installed sound system .....	16
As a band PA .....	18
Troubleshooting .....	20
Specifications .....	21
General specifications .....	21
Input specifications .....	22
Output specifications .....	23
Dimensions .....	23
Block Diagram .....	23

## Input specifications

Input connectors	PAD	Actual load impedance	Nominal impedance	Input level			Connector type
				Sensitivity*1	Nominal level	Max. before clipping	
CH INPUT (Lin) (CH1-6)	OFF	3 kΩ 10 kΩ	50-600Ω Mics	-62 dB (616μV)	-50 dB (2.45 mV)	-20 dB (77.5 mV)	XLR-3-31
	ON		600Ω Lines	-32 dB (19.5 mV)	-20 dB (77.5 mV)	+10 dB (2.45 V)	TRS jack
CH INPUT (MIC) (Ch110)	OFF	10 kΩ	50-600Ω Mics	-52 dB (1.95 mV)	-40 dB (7.75 mV)	-10 dB (245 mV)	XLR jack
	ON		600Ω Lines	-22 dB (61.6 mV)	-10 dB (245 mV)	+20 dB (7.75 V)	
LINE INPUT (CH7-10) (L, R)		10 kΩ	600Ω Lines	-22 dB (61.6 mV)	-10 dB (245 mV)	+20 dB (7.75 V)	Phone jack <sup>3</sup>
TAPE IN (L, R)		10 kΩ	600Ω Lines	-22 dB (61.6 mV)	-10 dB (245 mV)	+17.8 dBV (7V)	Phone jack
AUX IN (L,R)		10 kΩ	600Ω Lines	-22 dB (61.6 mV)	-10 dB (245 mV)	+20 dB (7.75 V)	Phone jack <sup>3</sup>

\*1. Sensitivity is the lowest level that can produce an output of +4 dB (1.23 V) or the nominal output level when the unit is set at maximum gain. (All level controls are at maximum position.)  
 \*2. Balanced.  
 \*3. Unbalanced.  
 • 0 dB=0.775 Vrms, 0 dBV=1 Vrms.

## Output specifications

Output connectors	Actual source impedance	Nominal impedance	Output level	Connector type
MAIN AMP OUT (L,R)	0.1Ω	4/8Ω Speaker	(200 W/4Ω)	Phone jack
MAIN BTL OUT	0.1Ω	8Ω Speaker	(400 W/8Ω)	Phone jack
MONITOR AMP OUT	0.1Ω	8Ω Speaker	(200 W/4Ω)	Phone jack
MAIN OUT (L, R)	600Ω	10 kΩ Lines	+20 dB (7.75 V)	Phone jack
MONITOR OUT	600Ω	10 kΩ Lines	+20 dB (7.75 V)	Phone jack
AUX OUT	600Ω	10 kΩ Lines	+20 dB (7.75 V)	Phone jack
TAPE OUT (1, 2)	600Ω	10 kΩ Lines	+10 dBV (3.16 V)	Phone jack

• All output jacks are unbalanced.  
 • 0 dB=0.775 Vrms, 0 dBV=1 Vrms.

Specifications are subject to change without prior notice.

# Specifications

## General specifications

<b>Maximum output power</b>	MODE2 or MODE3: 135 W+135 W/8Ω @0.5% THD at 1 kHz, 200 W+200 W/4Ω @0.5% THD at 1kHz MODE1 MAIN BRIDGE: 400W/8Ω @0.5% THD at 1kHz
<b>Frequency response</b>	20 Hz-20 kHz + 1 dB, -3 dB @ 1 W output into 8Ω (POWER AMP OUT) 20 Hz-20 kHz + 1 dB, -3 dB @+4 dB output into 10 kΩ (LEFT OUT, RIGHT OUT, MONITOR OUT, AUX OUT)
<b>Total harmonic distortion</b>	Less than 0.5% @20 Hz-20 kHz, 100 W output into 4Ω (POWER AMP OUT) Less than 0.3% @20 Hz-20 kHz, +14 dB output into 10 kΩ (LEFT OUT, RIGHT OUT, MONITOR OUT, AUX OUT)
<b>Hum &amp; noise (Average, Rs=150Ω) (with 20 Hz-20 kHz BPF)</b>	-123 dB equivalent input noise, -68 dB residual output noise (POWER AMP OUT)
	-93 dB residual output noise (LEFT OUT, RIGHT OUT, MONITOR OUT, AUX OUT)
	-78 dB (MAIN OUT) Master level control: nominal level, All channel level controls: minimum
	-75 dB (MONITOR OUT) Master level control: nominal level, All channel level controls: minimum
	-70 dB (MAIN OUT) Master level control: nominal level, 1 channel level controls: nominal level
<b>Maximum voltage gain (PAD: OFF)</b>	86 dB CH IN (MIC) to POWER AMP OUT (CH1-6)
	66 dB CH IN (MIC) to MAIN OUT, MONITOR OUT (CH1-6)
	72 dB CH IN (MIC) to EFFECT OUT (CH1-6)
<b>Crosstalk at 1 kHz</b>	48 dB CH IN (MIC) to REC OUT (CH1-6)
	56 dB CH IN (MIC) to MAIN OUT, MONITOR OUT (CH1-6)
	26 dB AUX IN to MAIN OUT
	24 dB TAPE IN to MAIN OUT
<b>Input channel equalization</b>	26 dB LINE IN to MAIN OUT (CH7-10)
	±15 dB Maximum HIGH 10 kHz shelving MID 2.5 kHz peaking LOW 100 Hz shelving * Turn over/roll-off frequency of shelving: 3 dB below maximum variable level.
<b>Meters</b>	5 POINTS LED METER (MAIN OUT L/R, )
<b>Graphic equalizer</b>	7 bands (125, 250, 500, 1k, 2k, 4k, 8k Hz) ±12 dB Maximum (MAIN OUT, MONITOR OUT)
<b>Internal digital effect</b>	16 types
<b>Phantom power</b>	+48 V is supplied to electrically balanced inputs for powering condenser microphones via 6.8 kΩ current limiting/isolation resistors.
<b>Limiters</b>	Comp.: THD ≥ 0.5% (MAIN, or MONITOR)
<b>LIMIT indicators</b>	Turns on: THD ≥ 0.5% (MAIN, or MONITOR)
<b>Foot switch</b>	DIGITAL EFFECT MUTE : on/off
<b>Power consumption</b>	650 W
<b>Dimensions (WxHxD)</b>	496x325x272 mm
<b>Weight</b>	15 kg

# Front and rear panel

## Control panel

### Channel section

Use these controls to adjust factors such as the equalization,(frequency response), volume, effect and monitor output level for the input signal to each channel.

#### 2 Monitor controls (MONI)

For each channel, this controls the amount of signal that is sent to the MONI bus.

The signal of the MONI bus is sent to the speakers connected to the MONITOR jacks and to the MONITOR jacks (input/output panel ⑥).

Note: The signal is sent to the MONITOR bus from a location before the level control (⑤) of each channel. This means that it will not be affected by the setting of the LEVEL control.

#### 3 EFX/AUX control

For each channel, this controls the amount of signal that is sent to the Aux bus.

The signal of the EFX bus passes through the EFFECT section and the built-in digital effect, and is sent to the external effect device connected to the AUX OUT jacks (input/output panel ③).

Note: The signal is sent to the EFFECT bus from a location after the level control (⑤) of each channel. This means that the amount of signal that is sent to the EFFECT bus will be affected not only by the setting of the effect control, but also by the setting of the level control.

#### 4 PAN control (BAL/PAN control for CH7-10)

This knob adjusts the stereo image (L/R) for each channel. Adjust for equal volume on left and right with a sound source input to the CH7 and 10 LINE connectors (L/R).

#### 5 Level control (LEVEL)

This adjusts the output level for each channel.

#### 6 Pad switch (PAD) (1-6 only)

This switch attenuates the input signal by 30 dB. When connecting a line level device to channels 1-6, or if the mic input is distorted, turn this switch on (the pressed-in position).

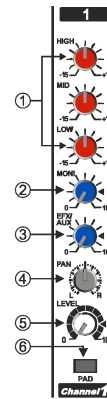

#### 1 Equalizer controls (HIGH, MID, LOW)

This is a 3-band equalizer that adjusts the high frequency range, mid frequency range, and low frequency range of each channel. Rotating it toward the right will boost the corresponding frequency band, and rotating it toward the left will cut it.

The bass frequency (or center frequency), range of boost or cut, and equalizer type of each band are as follows.

- HIGH: 10 kHz ±15 dB shelving type
- MID: 2.5 kHz ±15 dB peaking type
- LOW: 100 Hz ±15 dB shelving type

### ■ DIGITAL EFFECT section

This section allows you to turn the built-in digital effect on/off and to select the effect type.

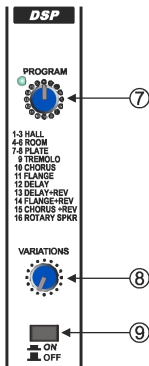

#### ⑦ Effect select switch

Select the effect type for the built-in digital effect.

#### ⑧ VARIATIONS controls

The knob adjusts the variations of digital effects.

#### ⑨ DIGITAL EFFECT ON switch

Use this switch to turn the digital effect on and off. When this switch is on, the AUX bus signal processed with the built-in digital effect is sent to the ST bus and MONI bus. The mix level of the effect sound is adjusted with the DSP to main and DSP to monitor controls.

### ■ AUX section

This section allows you to adjust the level of the signal sent from the AUX bus to an external effect device.

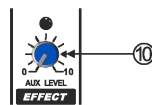

#### ⑩ AUX OUT level.

This adjusts the effect send level for an external effect device connected to the AUX OUT jack (input/output panel ③)

Note: The EFFECT OUT control does not affect the level sent to the built-in digital effect.

## Troubleshooting

The following table describes the possible malfunctions of this device, and the appropriate actions to be taken in each case.

Problem	Cause	Action
The POWER indicator is dark.	The load on this device was too great, and the protection circuit for the internal transformer has operated. Possible reasons for the excessive load are an excessive input to the device, or inappropriate ventilation.	Please wait. When the device cools off, normal operation will resume automatically. However, please check the following two points to prevent the problem from recurring. If the input to this device is greater than the nominal level, lower the input to the nominal level. If the device is not ventilated sufficiently, refer to the cautions given at the beginning of this manual and take appropriate measures to insure adequate ventilation.
Sound is no longer output from the speakers.	The load on the amplifier of this device was too great, and the protection circuit for the amplifier has operated. Possible reasons for the excessive load are an excessive level setting in the channel control section or main section, insufficient ventilation, or insufficient load impedance of the connected speakers.	Please wait. When the device cools off, normal operation will resume automatically. However, please check the following three points to prevent the problem from recurring. If the level setting is excessive, lower it to the nominal level. You can refer to the peak level indicators of the main section when doing so. If the device is not ventilated sufficiently, refer to the cautions given at the beginning of this manual and take appropriate measures to insure adequate ventilation. If the load impedance (including a short) is too low, refer to the chapter on connections (page 13) and change the connections so that the impedance is correct.
Other	Connections between devices have come loose.	Inspect the connections, and correct any faulty connections.
	Other	The device may have malfunctioned. Please contact your dealer.

### Using an external effect

- ① Set the AUX section AUX OUT control to the ◀ position.
- ② Raise the AUX controls for the channels to which you want the external effect to be applied.
- ③ Adjust the input level of the external effect so that the sound is not distorted at the input of the external effect.
- ④ Use the master section AUX IN control to adjust the level of the sound processed by the effect.

### ■ LEFT/MONITOR section

This section allows you to adjust the tone and volume of the LEFT/MONITOR bus, and adjust just the mix level of the built-in digital effect.

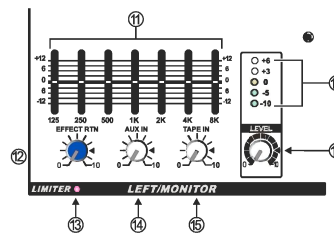

#### ⑪ Graphic equalizer

The CD1042S has a 7-band graphic equalizer for adjusting the frequency response of the LEFT/MONITOR bus signal. This allows you to cut or boost each frequency band by a maximum of  $\pm 12$ dB. You can use these sliders to reduce the level of frequency bands at which feedback easily occurs. Frequency response is flat when a slider is in the center position. Moving a slider in the positive direction will boost, and in the negative direction will cut.

These graphic equalizer settings affect both the LEFT/MONITOR bus signal output to the speakers and the line level signal sent from LEFT or MONI jack Signal (input/output panel ⑥).

#### ⑫ EFFECT RTN control

This control adjusts the effect signal level sent to the LEFT/MONITOR bus from the built-in digital effect.

#### ⑬ LIMITER indicator

This indicator lights up when the level of the signal output from the power amp section reaches the maximum and the limiter is activated.

#### ⑭ AUX IN control

This adjusts the amount of signal that is sent from The AUX IN jack to the left bus.

#### ⑮ TAPE IN control

This adjusts the amount of signal that is sent from The TAPE IN jacks to the left bus.

#### ⑯ LEVEL control(Volume)

This control adjusts the LEFT/MONITOR bus signal output level.

### ■ RIGHT/MAIN section

This section allows you to adjust the tone and volume of the ST bus, the mix level of the built-in effect, and the mix level of the external input.

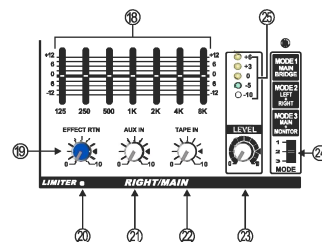

This setting is output to both the front and rear panel MONITOR jacks and appears in the MONI bus signal.

#### ⑰ Peak level indicator

This indicator allows you to monitor the level of the signal which is output from the MONITOR jack (input/output panel ⑥).

Note: To avoid distortion, adjust the LEVEL control (⑯) so that the 0 indicator lights occasionally.

#### ⑱ Graphic equalizer

The CD1042S has a 7-band graphic equalizer for adjusting the frequency response of the RIGHT/MAIN bus signal. This allows you to cut or boost each frequency band by a maximum of  $\pm 12$ dB.

These graphic equalizer settings affect both the RIGHT/MAIN bus signal output to the speakers and the line level signal output from the RIGHT/MAIN jack(input/output panel ⑥).

#### ⑲ EFFECT RNT control

Use this control to adjust the effect signal sent to the RIGHT/MAIN bus from the built-in digital effect.

#### ⑳ LIMITER indicator

This indicator lights up when the level of the signal output from the power@amp section reaches the maximum and the limiter is activated.

#### ㉑ AUX IN control

This adjusts the amount of signal that is sent from The AUX IN jack to the RIGHT bus.

### ② TAPE IN control

This adjusts the amount of signal that is sent from The TAPE IN jacks to the RIGHT bus.

### ③ LEVEL control (VOLUME)

This control adjusts the RIGHT/MAIN bus signal output level. This setting is output to the SPEAKERS RIGHT/MAIN jacks on the rear panel and appears in the RIGHT/MAIN bus signal.

### ④ STEREO/BRIDGE Select switch

Select a signal route depending on the speakers connected to the SPEAKERS jack ④ on the rear panel.

#### • LEFT+RIGHT

LEFT/RIGHT bus signals are output from the POWER-AMP L and POWER-AMP R jacks only the LEVEL control ③ or ④ is effective.

#### • MAIN+MONITOR

MAIN/MONITOR bus signals are output from the POWER-AMP MAIN and POWER-AMP MONITOR jacks only the LEVEL control ③ or ④ is effective.

#### • MAIN BRIDGE.

The monaural signal mixed in the L and R channels of the ST bus is output to the SPEAKERS MAIN BRIDGE jack. However, the ST bus Signal output from MAIN jack is still a stereo signal. A bridge connection is then made between the stereo power amps (200W+200W) to use them as a 400W monaural power amp.

### ⑤ Peak level indicator

This indicator allows you to monitor the level of the signal which is output from the MAIN (STEREO) jack (input/output panel ⑥).

Note: To avoid distortion, adjust the LEVEL control (③) so that the 0 indicator lights occasionally.

### ■ POWER indicator & PHANTOM section

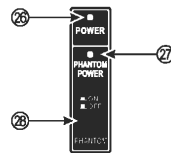

### ② POWER indicator

This indicator will light when the power of the CD1042S is turned on.

### ⑦ PHANTOM indicator

This indicator will light when the PHANTOM of the CD1042S is turned on.

### ⑧ PHANTOM power switch

This switch turns the phantom power supply on/off to the MIC inputs of channels 1-10.

## As a band PA

Here is an example of using the CD1042S as a small PA for a band. In this example, an external effect such as delay or reverb is also being used.

### Connections

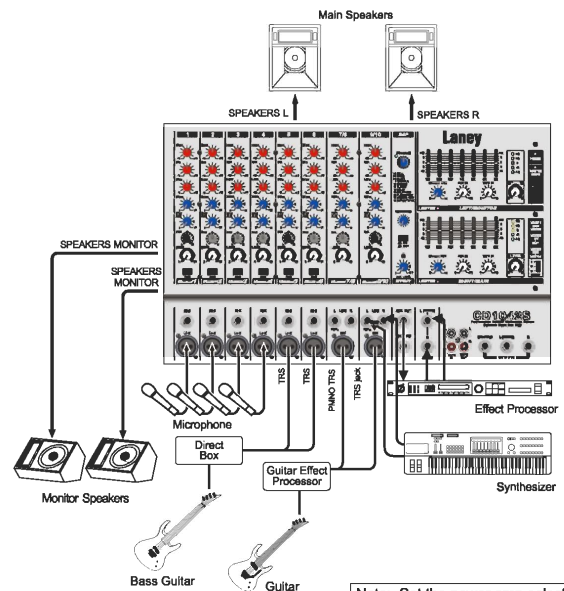

Connect mics or instruments, such as keyboards, to the channel input jacks 1-10.

Connect the main speakers to the SPEAKERS L/R's jacks, or connect the monitor speakers to the SPEAKERS MONITOR's jacks.

If you will be using an external effect such as delay or reverb, connect the CD1042S AUX OUT jack to the input jack of the external effect, and connect the output jack of the external effect to the CD1042S AUX IN jack.

Note: Set the power amp select switch of the POWER AMP section to the "LEFT+RIGHT" position.

If you are using an external effect, we recommend that you turn down the EFFECT RNT level controls of the MAIN and MONITOR sections.

If the external effect has a stereo output, it is possible to connect its output jacks to the LINE jacks of channels 7-8. However in this case, be sure that the AUX controls are turned all the way down for the channels into which the effect sound is being input. If the AUX controls are raised, feedback will occur, and your speakers may be damaged.



**Connections**

- Connect mics to channel inputs 1-10.
- If you wish to use an external device such as a CD player or LD player, connect the outputs of the device to the TAPE IN jacks of the CD1042S

Note: You can connect a stereo playback device, such as a CD player or an LD player, to channels 7-8 LINE inputs. The LINE inputs of Channel 9-10 can be used simultaneously but their levels cannot be separately adjusted.

- If you wish to record the audio from the mics to a cassette deck, connect the TAPE OUT jacks of the CD1042S to the input jacks of the cassette deck
- Connect the main speakers to the SPEAKERS L jacks and the SPEAKERS R jacks.
- Connect the monitor speakers to the SPEAKERS MONITOR jacks.

**Playing back a CD player**

- 1 Turn the power on in the order of peripheral devices then the CD1042S
- 2 Adjust the LEVEL control of the master section to the ◀ position.
- 3 Start playback on the CD player, and use the master section TAPE IN control to adjust the level so that the 0 LED of the Master section peak level meter does not light.

**Input/output panel**

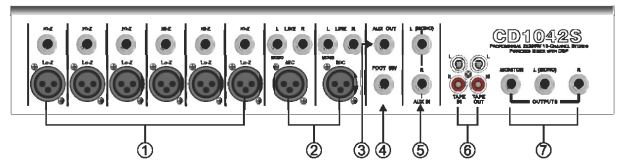

**1 Channel input jacks (Hi-z, Lo-z) 1-6**

These are the input jacks for channels 1-6. By using the PAD switches (control panel ⑥) you can connect any of the jacks to a wide range of sources from mics to line level devices (synthesizers or rhythm boxes etc.). The microphones can provide +48V phantom power, allowing you to use condenser microphones.

Both Hi-z and Lo-z are balanced, and are compatible with microphones of output impedance 50-600Ω or line level devices of 600Ω. The nominal input level is from -40 dB to -10 dB for the Lo-z input and from -50 dB to -20 dB for the Hi-z input.

Pin connections for the Hi-z and Lo-z jacks are as follows.

Hi-z (XLR type)	Lo-z (TRS phone jacks)
Pin 1: ground	Sleeve: ground
Pin 2: hot (+)	Tip: hot (+)
Pin 3: cold (-)	Ring: cold (-)

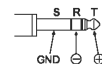

Note: It is not possible to simultaneously use both the Lo-z and Hi-z inputs of a given channel. For each channel, use only one of the inputs as appropriate for the input source. Phantom power is switched on/off in simultaneously for channels 1-6. For this reason, devices which do not require phantom power must be connected to the Hi-Z or Lo-z jacks if the PHANTOM +48 V switch (control panel ⑥) is on.

**2 Channel input jacks 7-10**

These are the input jacks for channels 7-10. Connect mic or line-level devices, such as synthesizers to LINE L(MONO)/R jacks if the devices are stereo sound sources. Use the LINE L(MONO) jack if the devices are monaural sound sources.

The LINE jacks are unbalanced, and are compatible with line level devices of 600Ω output impedance. Nominal input level is -20 dB for the LINE jacks.

Note: MIC/ LINE inputs for channel 9 can be used simultaneously but their levels cannot be adjusted separately(Same for channel 10.)

**3 Aux output jack (AUX OUT)**

The input of an external aux such as a delay or echo can be connected to this jack. The signal adjusted by the AUX control of each channel will be sent to the AUX bus, its level adjusted by the AUX OUT control, and output from this jack.

The nominal output level and impedance are +4dB /10 kΩ

**4 Foot switch jack (FOOT SW)**

You can connect a foot switch (sold separately) to this jack and use it to turn the built-in digital effect on and off.

**5 AUX IN jacks**

These are input jacks that allow the signal from an external device to be added to the MAIN output.

- AUX IN jacks: Connect these jacks to the output jacks of an external effects processor. If the effects processor has a stereo output, connect it to the AUX IN L (MONO) and R jacks. If it has monaural output, use the AUX IN L (MONO) jack. Signal input to these jacks is sent to the LEFT/RIGHT bus.

## ⑥ TAPE IN/TAPE OUT jacks

- **TAPE IN jacks:** Use these jacks to connect a stereo device, such as a cassette player or a CD player. The signals input to these jacks is sent to the ST bus.

The nominal input level and impedance are -10 dB/10K $\Omega$  for the TAPE IN jacks.

- **TAPE OUT jacks:** The ST bus signal before it has passed through the LEVEL control and graphic equalizer.

## ⑦ OUTPUTS jack:

These are output jacks which send line level signals from the CD1042S to external devices. A stereo recording device such as a playback device a poweramp can be connected to the MONITOR and MAIN(STEREO) jacks. The signals sent from each jack are as follows.

- **MONITOR jack:** The MONI bus signal which has passed through the Monitor MASTER control and graphic equalizer
- **LEFT jack:** The LEFT bus signal which has passed through the LEFT MASTER control and graphic equalizer
- **RIGHT jack:** The RIGHT bus signal which has passed through the RIGHT MASTER Control and graphic equalizer

The nominal output level and impedance are +0 dB/10 k $\Omega$  for the MONITOR/LEFT/RIGHT Jacks.

- ④ **Raise the AUX/DSP control of the channels to which you wish to apply the digital effect.**
- ⑤ **Use the MAIN/MONITOR section DSP LEVEL control to adjust the level of the sound processed by the effect.**

Note: If the effect sound is distorted even if the DSP LEVEL is turned all the way down, lower the AUX/DSP controls of each channel.

## Example setups

This section provides some ways in which the CD1042S can be used, and explains connections and operation.

### As a conference PA system/installed sound system

This example shows the CD1042S used as a conference PA system or sound system. A sound mix different from that of the main speakers can be sent to the monitor amp connected to the SPEAKERS MONITOR jacks.

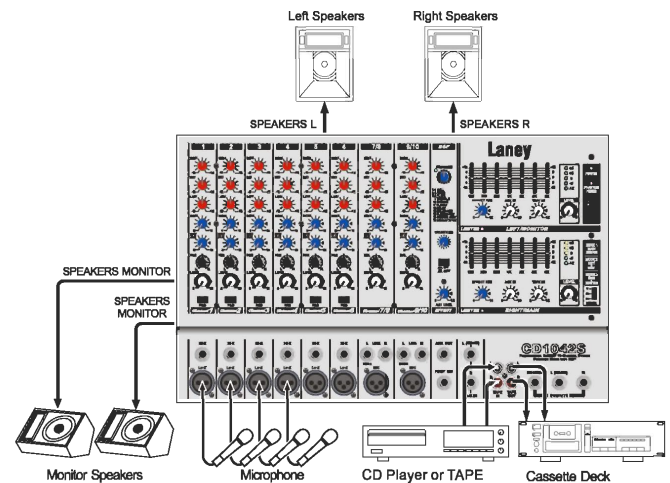

## Basic Operation

### Connecting microphones and instruments

- Before connecting mics or instruments, make sure that the power of all equipment (where applicable) is turned off. Also make sure that level controls of each channel of the CD1042S and the LEVEL control of the master section are turned down.
- Connect cables to your mics and instruments, and insert the other end of the cable firmly into the appropriate Hi-z/Lo-z (channels 1-10) or the LINE jack (channels 7-10).

Note: When connecting a line level device to channels 1-6, turn on the PAD switch. You cannot use a channel's Hi-z and Lo-z jacks, at the same time.

- Turn the power on in the order of peripheral devices- CD1042S

Note: When turning the power off, reverse this sequence.

- Set the master section LEVEL control to the ◀ position.

Adjusts the stereo image of each channel using the PAN controls. (Adjust the balance between the left and right volume levels of the sound sources connected to the Lo-z connectors L/R for channels 7-10 using the BAL/PAN controls).

- While speaking into the mic (while playing the instrument), adjust the channel LEVEL control so that the 0 LED of the master section peak level meter lights occasionally.

- If you wish to adjust the tone of each channel, rotate the equalizer controls as desired.

- Use the master section graphic equalizer and LEVEL control to adjust the overall volume and tone.

### Sending an independent mix to the monitor speakers

- Set the MONITOR section LEVEL control to the ◀ position.
- Adjust the MONI control to increase the level of the channel you want to hear from the monitor speaker, and also adjust so that the peak level meter 0 LED of the monitor section lights up occasionally.

Note: The MONI controls are not affected by the level settings of each channel. This allows you to create a mix that is independent of the Master section.

- Use the graphic equalizers and master controls of the LEFT/MONITOR sections to adjust the overall volume and tone.

### Using the digital effect

The CD1042S has a built-in digital effect, allowing reverberation or ambiance to be added to vocals or instrumental sounds.

- Connect a mic or instrument to the desired channels, and adjust the volume and tone.

- Press the DIGITAL EFFECT ON switch of the DIGITAL EFFECT section.

- Use the effect select switches of the DIGITAL EFFECT section to select the effect type.

① HALL 1	⑩ TREMOLO
② HALL 2	⑪ CHORUS
③ HALL 3	⑫ FLANGE
④ ROOM 1	⑬ DELAY
⑤ ROOM 2	⑭ DELREV
⑥ ROOM 3	⑮ FLANREV
⑦ PLATE 1	⑯ CHORREV
⑧ PLATE 2	⑰ ROTASPK

- Use the parameter knob of the digital effect to adjust the effect parameter.

### Rear panel

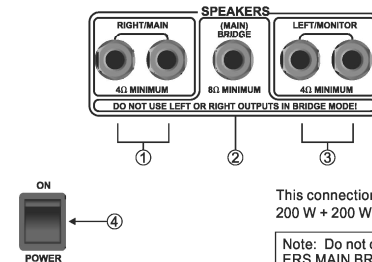

This connection provides a maximum output of 200 W + 200 W.

Note: Do not connect anything to the SPEAKERS MAIN BRIDGE jack when you are using this 2-channel connection.

- SPEAKERS RIGHT/MAIN jacks**

Connect monitoring speakers to these jacks. RIGHT /MAIN bus signals adjusted at the RIGHT/MAIN section are output from these jacks. The SPEAKERS RIGHT/MAIN jacks are internally connected in parallel, and output the same signals. You can connect speakers with an impedance of 4-8Ω to either. You can connect speakers with an impedance of 8-16Ω to both Pairs.

Note: Do not connect any devices other than speakers to these jacks. Do not confuse these jacks with the RIGHT/MAIN jacks on the I/O panel.

- SPEAKERS MAIN BRIDGE jacks**

Use these jacks to connect the main speakers. These jacks output MAIN bus signals that are adjusted at the LEVEL section. The speaker connection varies depending on the setting of the mode select switch.

### When the MODE select switch is set to RIGHT+LEFT(2-channel connection)

L/R channel signals are routed from the ST bus to the SPEAKERS L/R jacks. The SPEAKERS L jacks are internally wired in parallel and output the same signals. You can connect a pair of speakers with an impedance of 4-8Ω to either or both the LEFT or RIGHT pair of the SPEAKER L/R jacks(total of two speakers). You can connect two pairs of speakers with an impedance of 8-16Ω to the SPEAKER L/R jacks(total of four speakers).

- When the MODE select Switch is set to MAIN BRIDGE

L/R channel signals are mixed in the ST bus and routed to the SPEAKERS MAIN BRIDGE jack as a monaural signal. You can connect only one speaker with an impedance of 8-16Ω to the SPEAKERS MAIN BRIDGE jack. This connection provides the maximum output of 400 W.

Note: Do not connect anything to the SPEAKERS L/R jacks if you use this BRIDGE connection.

- SPEAKERS LEFT/MONITOR jacks**

Connect monitoring speakers to these jacks. MONITOR bus signals adjusted at the MONITOR section are output from these jacks. The SPEAKERS MONITOR jacks are internally connected in parallel, and output the same signals. You can connect speakers with an impedance of 4-8Ω to either. You can connect speakers with an impedance of 8-16Ω to both Pairs.

Note: Do not connect any devices other than speakers to these jacks. Do not confuse these jacks with the LEFT/MONITOR jacks on the I/O panel.

- Power switch**

This switch turns the power of the CD1042S on/off.

Note: Before turning the CD1042S on/off, turn down fully the LEVEL controls of the MONITOR and MAIN section.

## Connections

When connecting various devices, make sure the cables and plugs have the correct rating. Be sure to use cables designed for the purpose when you connect speakers to speaker jacks.

### ■ Connecting left/monitor speakers

You can connect one or two speakers to the SPEAKERS LEFT/MONITOR jacks. Speaker impedance varies with the number of speakers that are connected. Be sure to maintain speaker impedance at the specified value or higher, refer to the figure below.

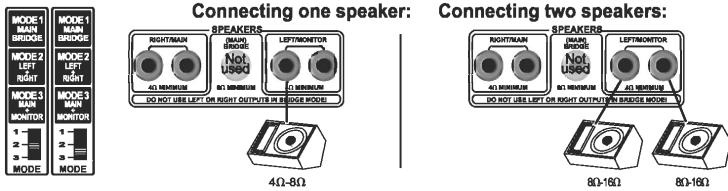

### ■ Connecting right/main speakers

You can connect one or two speakers to the SPEAKERS RIGHT/MAIN jacks. Speaker impedance varies with the number of speakers that are connected. Be sure to maintain speaker impedance at the specified value or higher, refer to the figure below.

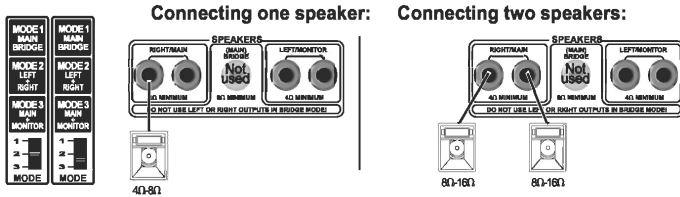

### ■ Connecting Bridgemode speakers

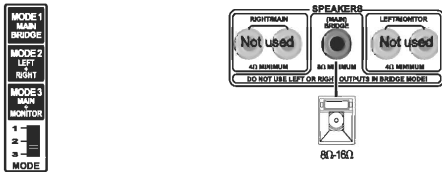

## ■ Example connections

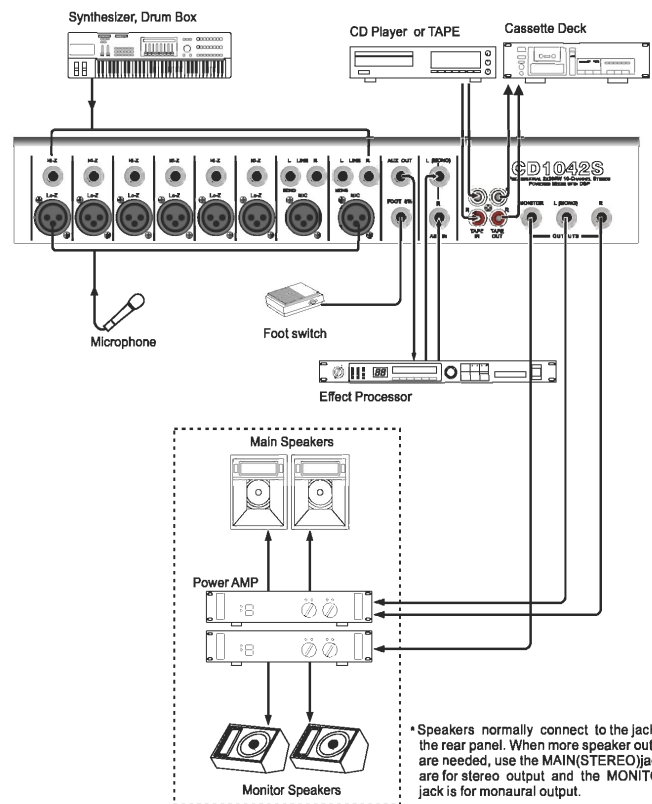

\*Speakers normally connect to the jacks on the rear panel. When more speaker outputs are needed, use the MAIN (STEREO) jacks are for stereo output and the MONITOR jack is for monaural output.