

RB4

Laney
POWER TO THE MUSIC

USER MANUAL

IMPORTANT SAFETY INSTRUCTIONS









WARNING: When using electric products, basic cautions should always be followed, including the following.

1. Read all safety and operating instructions before using this product
2. The product should be powered by a three pin grounded (or earthed) plug connected to a power socket with a grounded earth outlet.
3. All safety and operating instructions should be retained for future reference
4. Obey all cautions in the Operating instructions and on the back of the unit
5. All operating instructions should be followed
6. This product should not be used near water; i.e. a bathtub, sink, swimming pool, wet basement, etc.
7. This product should be located so that its position does not interfere with its proper ventilation. It should not be placed flat against a wall or placed in a built up enclosure that will impede the flow of cooling air.
8. This product should not be placed near a source of heat such as stove, radiator, or another heat producing amplifier.
9. Connect only to a power supply of the type marked on the unit adjacent to the power supply cord.
10. Never break off the ground pin on a power supply cord.
11. Power supply cords should always be handled carefully. Never walk or place equipment on power supply cords. Periodically check cords for cuts or signs of stress, especially at the plug and the point where the cord exits the unit.
12. The power supply cord should be unplugged when the unit is to be unused for long periods of time.
13. If this product is to be mounted in an equipment rack, rear support should be provided.
14. The user should allow easy access to any mains plug, mains coupler and mains switch used in conjunction with this unit thus making it readily operable.
15. Metal parts can be cleaned with a damp cloth. The vinyl covering used on some units can be cleaned with a damp cloth or ammonia based household cleaner if necessary.
Disconnect the unit from the power supply before cleaning.
16. Care should be taken so that objects do not fall and liquids are not spilled into the unit through any ventilation holes or openings. On no account place drinks on the unit.
17. A qualified service technician should check the unit if:
 - The power cord has been damaged
 - Anything has fallen or spilled into the unit
 - The unit does not appear to operate correctly
 - The unit has been dropped or the enclosure damaged.
18. The user should not attempt to service the equipment. All service work is done by a qualified service technician.
19. Exposure to extremely high noise levels may cause a permanent hearing loss. Individuals vary considerably in susceptibility to noise induced hearing loss, but nearly everyone will lose some hearing if exposed to sufficiently intense noise for a sufficient time. The U.S. Government's Occupational Safety and Health Administration (OSHA) has specified the following permissible noise level exposure.

Duration Per Day In Hours	Sound Level dBA, slow response
8	90
6	92
4	95
3	97
2	100
1 ½	102
1	105
½	110
¼ or less	115

According to OSHA, any exposure in excess of the above permissible limits could result in some hearing loss. Ear plugs or protectors in the ear canals or over the ears must be worn when operating this amplification system in order to prevent a permanent hearing loss if exposure exceeds the limits set forth above. To ensure against potentially dangerous exposure to high sound pressure levels it is recommended that all persons exposed to equipment capable of producing high sound pressure levels such as this amplification system be protected by hearing protectors while this unit is in operation.

SAVE THESE INSTRUCTIONS

	<p>Intended to alert the user to the presence of uninsulated "dangerous voltage" within the product's enclosure that may be of sufficient to constitute a risk of electrical shock to persons</p>
	<p>Intended to alert the user of the presence of important operating and maintenance (servicing) instructions in the literature accompanying the product</p>
<p>CAUTION: Risk of electrical shock - DO NOT OPEN</p>	
<p>CAUTION: To reduce the risk of electrical shock, do not remove the cover. No user servicable parts inside. Refer servicing to qualified service personnel.</p>	
<p>WARNING: To prevent electrical shock or fire hazard, do not expose this appliance to rain or moisture. Before using this appliance please read the operating instructions for further warnings</p>	
	<p>Este simbolo tiene el proposito de alertar al usuario de la presencia de "(voltaje) peligroso" que no tiene aislamiento dentro de la caja del producto que puede tener una magnitud suficiente como para constituir riesgo de corrientazo</p>
	<p>Este simbolo tiene el proposito de alertar al usuario de la presencia de instrucciones importantes sobre la operacion y mantenimiento en la literatura que viene con el producto</p>
<p>PRECAUCION: Riesgo de corrientazo - no abra</p>	
<p>PRECAUCION: Para disminuir el riesgo de corrientazo, no abra la cubierta. No hay piezas adentro que el pueda reparar. Deje todo mantenimiento a los tecnicos calificados</p>	
<p>ADVERTENCIA: Para evitar corrientazos o peligro de incendio, no deja expuesto a la lluvia o humedad este aparato Antes de usar este aparato, lea mas advertencias en la guia de operacion</p>	
	<p>Ce symbole est utilise pur indiquer a l'utilisateur de ce produit de tension non-isolee dangereuse pouvant etre d'intensite suffisante pour constituer un risque de choc electrique.</p>
	<p>Ce symbole est utilise pour indiquer a l'utilisateur qu'il ou qu'elle trouvera d'importantes instructions sur l'utilisation et l'entretien (service) de l'appareil dans la litterature accompagnant le produit</p>
<p>ATTENTION: Risques de choc electrique - NE PAS OUVIRIR</p>	
<p>ATTENTION: Afin de reduire le risque de choc electrique, ne pas enlever le couvercle. Il ne se trouve a l'interieur aucune piece pouvant etre reparee par l'utilisateur. Confier l'entretien a un personnel qualifie.</p>	
<p>AVERTISSEMENT: Afin de prevenir les risques de decharge electrique ou de feu, n'exposez pas cet appareil a la pluie ou a l'humidite. Avant d'utiliser cet appareil, lisez les avertissements supplementaires situes dans le guide.</p>	
	<p>Dieses Symbol soll den Anwender vor unisolierten gefahrlichen Spannungen innerhalb des Gehauses warnen, die von Ausreichender Starke sind, um einen elektrischen Schlag verursachen zu konnen.</p>
	<p>Dieses Symbol soll den Benutzer auf wichtige Instruktionen in der Bedienungsanleitung aufmerksam machen, die Handhabung und Wartung des Produkts betreffen.</p>
<p>VORSICHT: Risiko - Elektrischer Schlag! Nicht offen!</p>	
<p>VORSICHT: Um das Risiko eines elektrischen Schlages zu vermeiden, nicht die Abdeckung entfernen. Es befinden sich keine Teile darin, die vom Anwender repariert werden Konnten. Reparaturen nur von qualifiziertem Fachpersonal durchfuhren lassen</p>	
<p>ACHTUNG Um einen elektrischen Schlag oder Feuergefahr zu vermeiden, sollte dieses Gerat nicht dem Regen oder Feuchtigkeit ausgesetzt werden. Vor Inbetriebnahme unbedingt die Bedienungsanleitung lesen.</p>	

BEFORE SWITCHING ON

After unpacking your amplifier check that it is factory fitted with a three pin 'grounded' (or earthed) plug. Before plugging into the power supply ensure you are connecting to a grounded earth outlet.

If you should wish to change the factory fitted plug yourself, ensure that the wiring convention applicable to the country where the amplifier is to be used is strictly conformed to. As an example in the United Kingdom the cable colour code for connections are as follows.

EARTH OR GROUND - GREEN/YELLOW
NEUTRAL - BLUE
LIVE - BROWN



NOTE

This manual has been written for easy access of information. The front and rear panels are graphically illustrated, with each control and feature numbered. For a description of the function of each control feature, simply check the number with the explanations adjacent to each panel.

Your Laney amplifier has undergone a thorough two stage, pre-delivery inspection, involving actual play testing.

When you first receive your Laney Bass amp, follow these simple procedures:

- (i) Ensure that the amplifier is the correct voltage for the country it is to be used in.
- ii) Connect your instrument with a high quality shielded instrument cable. You have probably spent considerable money on your amplifier and guitar - don't use poor quality cable it won't do your gear justice.

Please retain your original carton and packaging so in the unlikely event that some time in the future your amplifier should require servicing you will be able to return it to your dealer securely packed.

Care of your Laney amplifier will prolong it's life.....and yours!

Dear Player,

Thank you very much for purchasing your new Laney product and becoming part of the worldwide Laney family. Each and every Laney unit is designed and built with the utmost attention to care and detail, so I trust yours will give you many years of enjoyment.

Laney products have a heritage which stretches back to 1967 when I first began building valve amplifiers in my parent's garage. Since then we have moved on from strength to strength developing an extensive range of guitar, bass, public address and keyboard amplification products along with a list of Laney endorsees that includes some of the world's most famous and respected musicians. At the same time we believe we have not lost sight of the reason Laney was founded in the first place - a dedication to building great sounding amplification for working musicians.

Warm Regards,



Lyndon Laney CEO



INTRODUCTION

The RB4 is a 165W bass combo with a 15 inch loudspeaker in a sturdy wooden cabinet. Its features include; two 1/4" jack inputs for Normal / Hi level signals, a gain control and a switchable compressor; a flexible EQ system with Bass, Treble, a rotary Enhance control and 7 band graphic equalizer; a power amplifier limiter which can be switched in/out as needed and a balanced XLR Direct out is present should you need to connect to a PA or recording device. On the rear is an FX loop for connection of external FX, a dedicated output for a tuner and an external speaker socket for connecting additional cabinets.

An explanation of these features follows on pages 6-8.

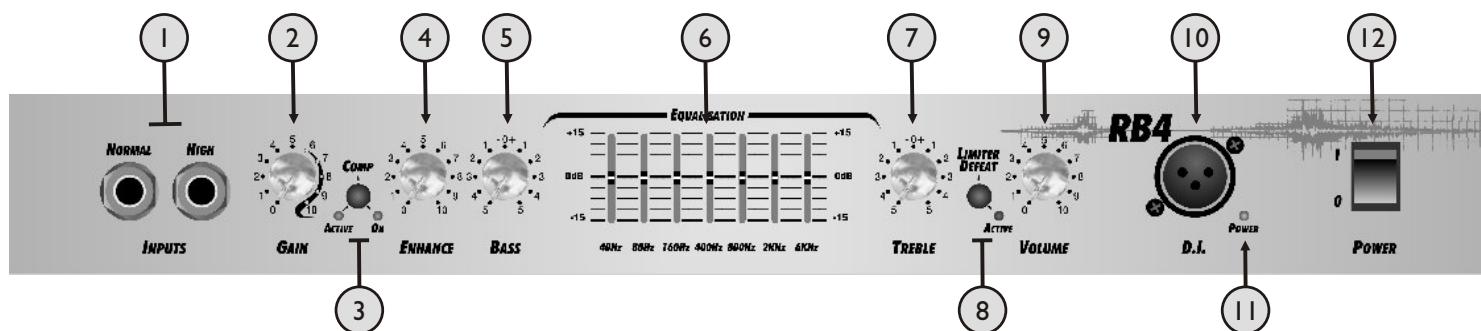

FRONT PANEL CONTROLS

- ① Normal and High inputs are provided for connection of bass guitars. High output basses, either Active or Passive should be connected via the High socket. Low output basses should be connected using the normal input. High output basses may also be placed in the Normal input if pre-amp overloading is desired.
- ② This control is used to set the level of gain present in the pre-amp. The higher the level of gain, the more the signal will clip producing distortion. The Gain control should be used in conjunction with the Volume control ⑨ to produce the desired signal characteristics.
- ③ Engages and disengages the on-board compressor; this compresses the input-signal giving a punchier sound. In association with the compressor are two LEDs, one indicating that the compressor is engaged and one indicating the compressor is active. The amount of compression is controlled by the Gain control. The higher the setting the more compression. With most guitars compression will begin at about 5-6 on the control. It is possible to have the compressor engaged but it only be active during certain periods of playing - typically the most dynamic sections.
- ④ The Enhance control provides an increased definition at the low-end of the frequency spectrum giving you a tighter, punchier sound. The Enhance control does this by providing a dip in the frequency-response of the amplifier at approximately 150Hz. This dip reduces some of the harmonics of the important low-frequencies around 40-80 Hz producing better definition to your sound. Turning the control through to its maximum has the effect of boosting both the low and high-frequency content.

- 5 Controls the boost and cut of the low-frequency response of the pre-amplifier.
- 6 The seven band graphic equalizer allows you to easily modify your tone and effectively 'see' the response you are getting. There are seven sliders covering a frequency range from 40Hz right through to 6KHz. When the slider is in the central position the signal at that frequency is unaffected or flat. Moving the slider up or down from the centre will Boost or Cut that frequency.
- 7 Controls the boost and cut of the high-frequency response of the pre-amplifier.
- 8 Allows the on-board limiter to be defeated if desired. With the switch in the out position the limiter is engaged. The limiter is automatically triggered at high-output levels and is designed to prevent power-amp distortion at high-output levels. When the limiter is automatically triggered the LED lights up to indicate the limiter is active. It is possible to have the limiter engaged but not have the LED active. The limiter monitors both power-amp clipping and speaker load so it automatically registers the cabinet-impedance and sets itself accordingly.
- 9 Sets the overall listening level of the amplifier.
- 10 XLR socket for direct-injection of the amplifier signal to a mixing-desk or additional power-amplifier. The XLR socket provides a balanced low-impedance output-signal from the pre-amplifier taken before any tone correction.
- 11 Indicates power is connected and the amplifier is switched on.
(Always switch off and disconnect power cord when not in use)
- 12 Main power on/off switch

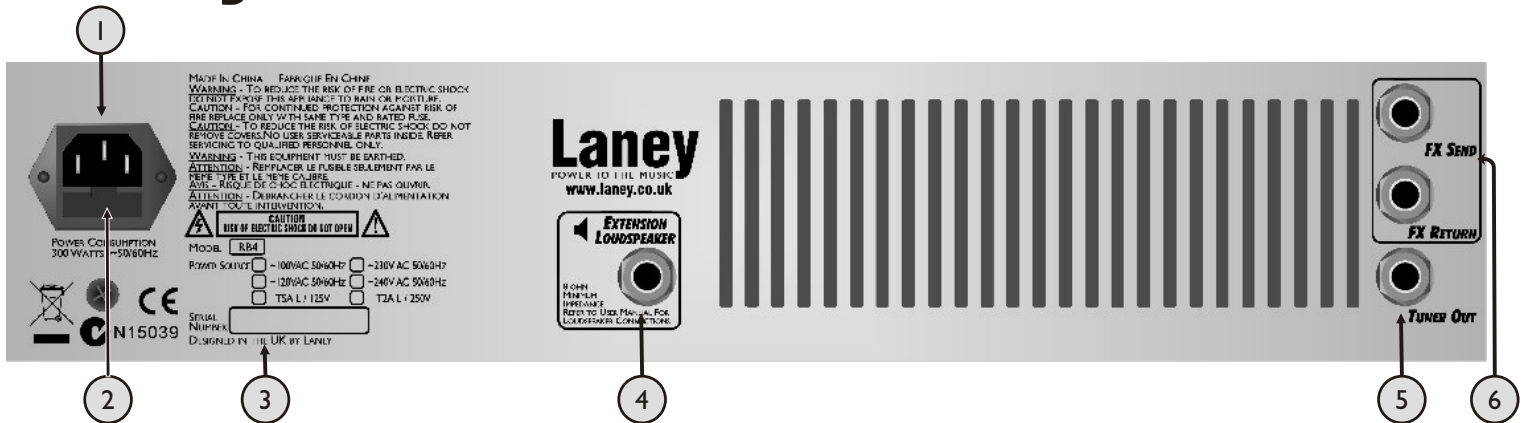

REAR PANEL CONTROLS

- 1 Power inlet socket. Connect to your power source. Make sure the specified voltage is correct for your country!
- 2 The main safety fuse for the unit is inside this drawer.
USE ONLY THE CORRECT SIZE AND RATING OF FUSE AS SPECIFIED ON THE PANEL.
The mains fuse ratings are detailed in the specs section at the rear of this manual.
- 3 Serial Number and model of your unit.
- 4 This socket(s) should be used to connect an extension-cabinet. The impedance of the extension-cabinet must not be less than 8 Ohms. Connecting cabinets that have a lower impedance than 8 Ohms will result in the amplifier overheating. Continual use in this manner may cause permanent damage. Connecting a cabinet with an impedance of greater than 8 Ohms will cause no damage to the amplifier but will result in a reduced output level. (When using an extension cabinet the internal speaker remains connected)
- 5 Socket for connecting external tuner. This output is taken before any EQ processing so the Volume control may be turned down for silent tuning.
- 6 Send and return sockets are provided for connecting external effects-units. You can also use the Send socket as a line out if you wish.

BLOCK DIAGRAM

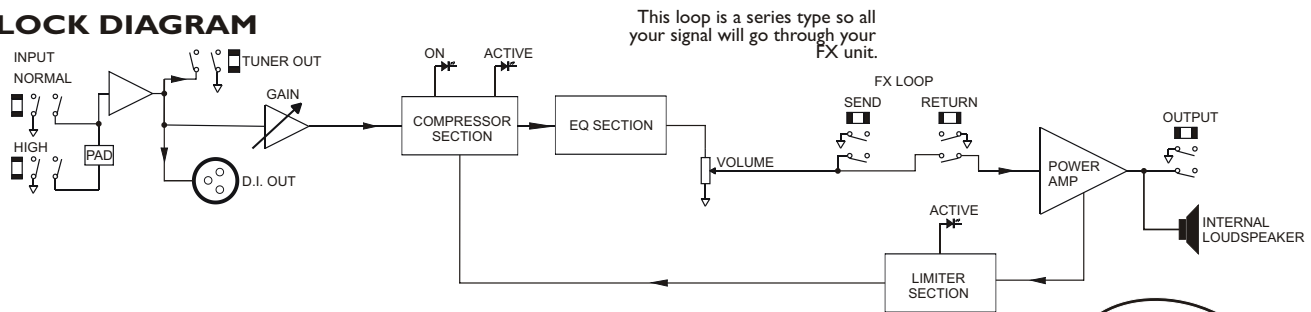

SAMPLE SYSTEM

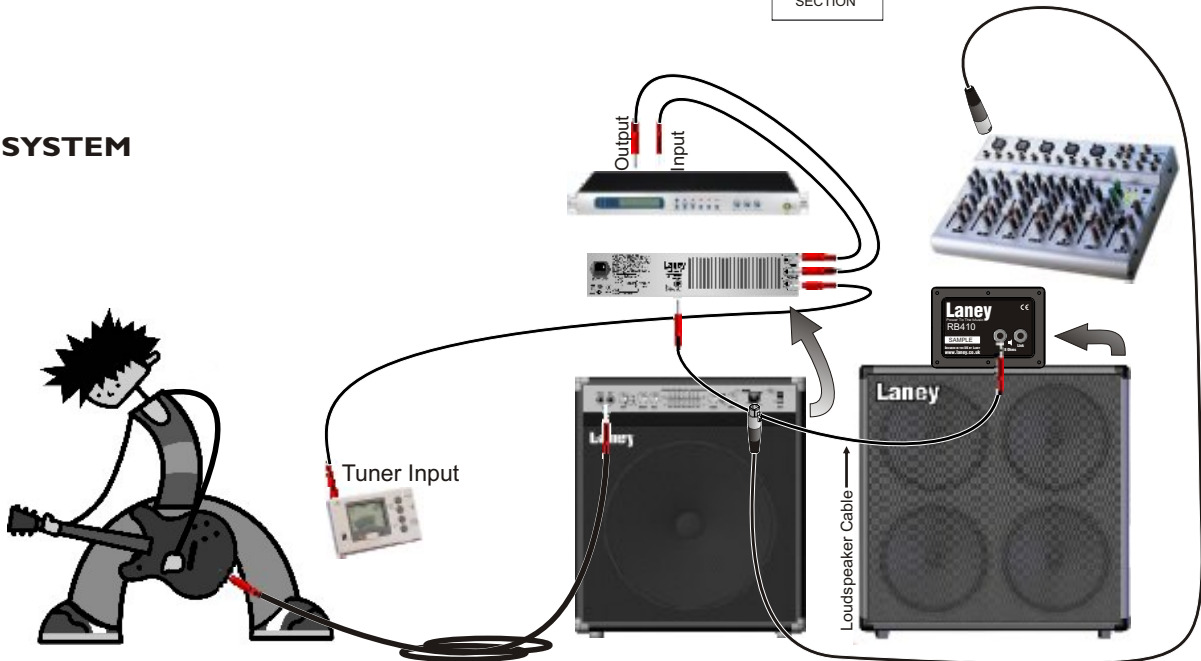

USER SETTINGS

Found some cool settings you want to keep? Make a note of them here:

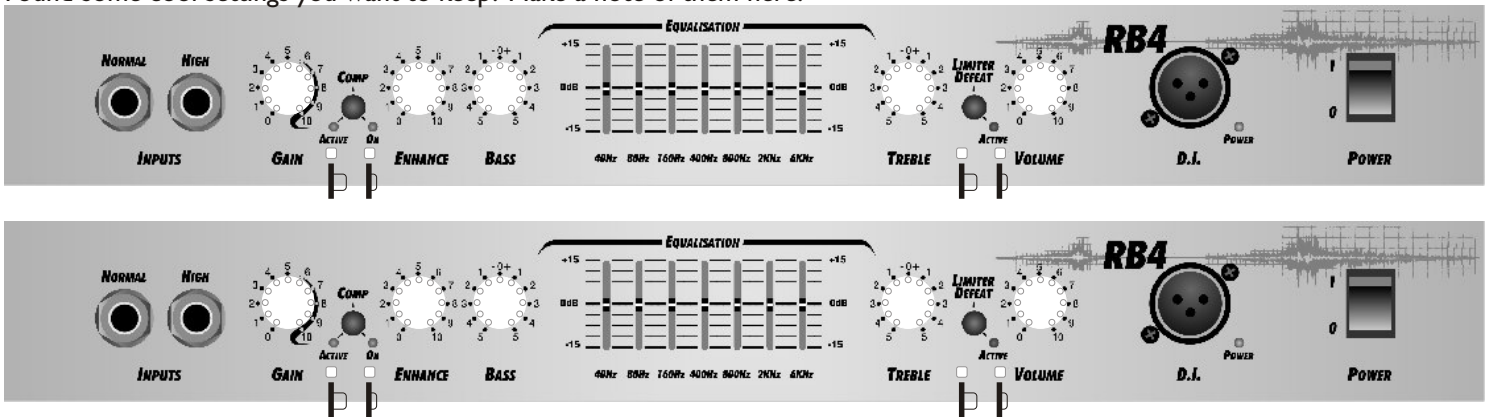

General Notes

Amplifier connection. In order to avoid damage, it is advisable to establish and follow a pattern for turning on and off your equipment. With all system parts connected, turn on source equipment, tape decks, cd players, mixers, effects processors etc. BEFORE turning on your Bass Amplifier. Many products have large transient surges at turn on and off which can cause damage to your speakers. By turning on your Bass Amplifier LAST and making sure its Volume control is set to minimum any transients from other equipment will not reach your loudspeakers. Wait until all system parts have stabilised; usually a couple of seconds. Similarly when turning off your system always turn down the Volume control on your Bass Amplifier and then turn off its power before turning off other equipment.

Cables- never use shielded or microphone cable for any speaker connections as this will not be substantial enough to handle the amplifier load and could cause damage to your amplifier system.

Caution: These professional loudspeaker systems are capable of generating very high sound pressure levels. Use care with placement and operation to avoid exposure to excessive levels that can cause permanent hearing damage. (Refer to guidelines on page 2)

Servicing: The user should not attempt to service these products. Refer all servicing to qualified service personnel.

SPECIFICATIONS

Supply Voltage	~100V, ~120V, ~220V, ~230V, ~240V 50/60Hz Factory Option	
Mains Fuse	~220V>~240V = T2A L. ~100>120V = T5A L (Time delay)	
Power Consumption	300W	
Output Power Rating	165W	
Loudspeaker	15" Custom Designed Driver	
Features	Normal + Hi Inputs Switchable Compressor with status lights Switchable Limiter with status light Enhance	
EQ	Bass	(±12dB at 40Hz, Shelving)
	7 Band Graphic	(±12dB at 40, 80, 160, 400, 800, 2K, 6K Peaking)
	Treble	(±15dB at 3.5KHz, Shelving)
D.I.	Yes, Balanced XLR	
Tuner Out	Yes	
Extension Loudspeaker Socket	Yes	(8 Ohms minimum)
FX Loop	Yes	(0dBu Nominal) (Series-Insert)
Input Impedance	1M Ohm/100pF	
Recommended Min Extension Speaker Power	100W	
Recommended Richter Extension Cab	RB410 / RB115	
Size	578*505*335	(H*W*D)
Unit Weight	25.25 Kg	
Packing Weight	28 Kg	

This product conforms to:
European EMC directive (2004/108/EC), Low Voltage Directive (72/23/EEC) and CE mark Directive (93/68/EEC)

Laney

POWER TO THE MUSIC



@

www.laney.co.uk

In the interest of continued product development, Laney reserves the right to amend product specification without prior notification.