

ALLEN & HEATH

GR4

INSTALLATION & USER GUIDE

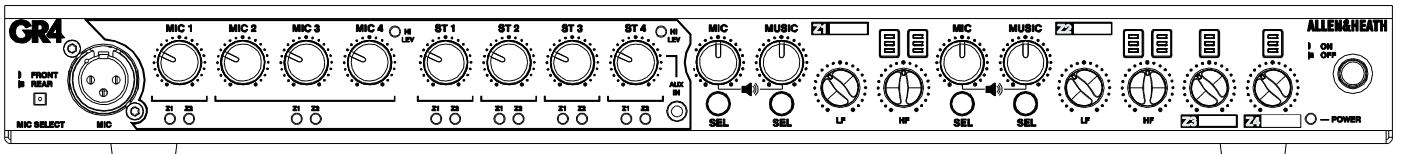

ANALOGUE ZONE SERIES

Limited One Year Manufacturer's Warranty

Allen & Heath warrants the Allen & Heath branded hardware product and accessories contained in the original packaging ("**Allen & Heath Product**") against defects in materials and workmanship when used in accordance with Allen & Heath's user manuals, technical specifications and other Allen & Heath product published guidelines for a period of ONE (1) YEAR from the date of original purchase by the end-user purchaser ("**Warranty Period**").

This warranty does not apply to any non-Allen & Heath branded hardware products or any software, even if packaged or sold with Allen & Heath hardware.

Please refer to the licensing agreement accompanying the software for details of your rights with respect to the use of software/firmware ("EULA").

Details of the EULA, warranty policy and other useful information can be found on the Allen & Heath website:

Repair or replacement under the terms of the warranty does not provide right to extension or renewal of the warranty period. Repair or direct replacement of the product under the terms of this warranty may be fulfilled with functionally equivalent service exchange units. This warranty is not transferable.

This warranty will be the purchaser's sole and exclusive remedy and neither Allen & Heath nor its approved service centres shall be liable for any incidental or consequential damages or breach of any express or implied warranty of this product.

Conditions Of Warranty

The equipment has not been subject to misuse either intended or accidental, neglect, or alteration other than as described in the User Guide or Service Manual, or approved by Allen & Heath.

Any necessary adjustment, alteration or repair has been carried out by an authorised Allen & Heath distributor or agent.

The defective unit is to be returned carriage prepaid to the place of purchase, an authorised Allen & Heath distributor or agent with proof of purchase. Please discuss this with the distributor or the agent before shipping. Units returned should be packed in the original carton to avoid transit damage.

DISCLAIMER: Allen & Heath shall not be liable for the loss of any saved/stored data in products that are either repaired or replaced.

Check with your Allen & Heath distributor or agent for any additional warranty information which may apply. If further assistance is required please contact Allen & Heath Ltd.

CE GR products comply with the European Electromagnetic Compatibility directive 2014/30/EU and the European Low Voltage directive 2014/35/EU.

Any changes or modifications to the product not approved by Allen & Heath could void the compliance of the product and therefore the user's authority to operate it.

GR4 User Guide

Copyright © 2016 Allen & Heath. All rights reserved.

ALLEN & HEATH

Allen & Heath Limited, Kernick Industrial Estate, Penryn, Cornwall, TR10 9LU, UK

Contents

1	Introduction	4
2	Packed Contents	4
3	Front Panel	5
3.1	Input Section.....	5
3.2	Output Section.....	6
3.3	General	7
4	Rear Panel	7
4.1	General	7
4.2	Control Section.....	8
4.3	Output Section.....	8
4.4	Input Section.....	9
5	Installing GR4	10
5.1	Mounting the unit.....	10
6	Connecting to GR4.....	11
6.1	Microphone Inputs	11
6.2	Stereo Inputs	11
6.3	Zone Outputs.....	12
6.4	Alarm Input	13
6.5	Page Input	14
6.6	Remote Connection	14
7	Setting up GR4	16
7.1	Operating Features	16
7.2	Internal Jumper Settings	17
7.3	Dip Switch Settings	18
7.4	Programming Parameters.....	19
8	FAQ.....	20
9	Block Diagram	21
10	Specifications.....	22
11	Connection Diagram.....	23
12	Application Examples	24

Before starting, read the Important Safety Instructions printed on the sheet supplied with the equipment. For your own safety and that of the operator, technical crew and performers, follow all instructions and heed all warnings printed on the sheet and on the equipment panels.

1 Introduction

8in / 4out Zone Mixer

The GR4 is a 1U rack-mounting or desktop audio mixer, providing simple yet comprehensive control of background music and paging in bars, restaurants, stores and other leisure / retail environments. Standout features include optional remote wall plates, a mic input on the front panel, plus a 3.5mm jack on the front for portable music sources.

2 Packed Contents

The following items are included in the box when the GR4 is shipped.

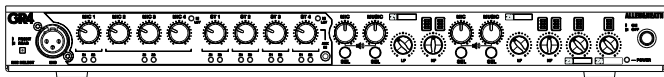

1 x GR4 Zone Mixer

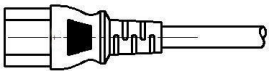

1 x Mains Cable
(IEC C13 to local
mains connector)



19 x Blanking
Bung

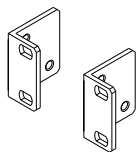

1 x Set of Rack
ears



4 x M3 X 6mm
Countersunk
Pozi screws



2 x Header Plug
Euroblock 2-



2 x Header Plug
Euroblock 4-



10 x Header Plug
Euroblock 3-Pole

1 x User Guide (AP10223).

1 x ROHS Addendum Notes (AP7014).

1 x Safety Instructions (AP9240/CL1-1) - **PLEASE READ BEFORE CONTINUING WITH THIS MANUAL.**

3 Front Panel

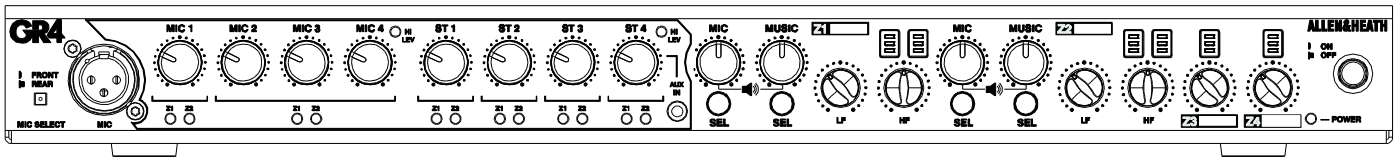

3.1 Input Section

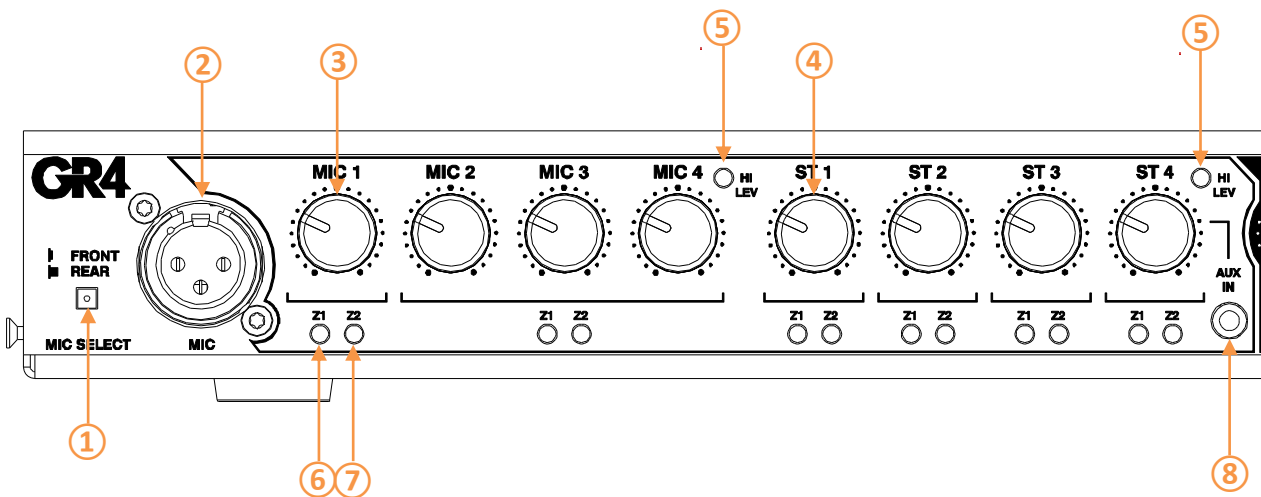

① MIC SELECT – a user selectable switch for MIC 1 input. MIC 1 signal can either be derived from the rear mount Euroblock or front mount XLR connectors. Use pointed object to select switch.

② MIC 1 INPUT – Front mount XLR receptacle for MIC 1 input.

③ MIC LEVEL – Adjustable rotary level control for MIC inputs 1-4. Mic level control of Off to +6dB.

④ ST LEVEL – Adjustable rotary level control for LINE inputs 1-4. Line level control of Off to +6dB.

⑤ Hi LEV LED – LED level indicator which illuminates when signal to MIC 1-4 and ST 1 to 4 is approaching clip level. The Hi Level LED illuminates when one or more inputs are at 3dB before clip level.

⑥ AUX INPUT – Auxiliary input on 3.5mm jack socket.

This input will override any input connected to ST4 on the rear Euroblock connector.

⑦ Z1 SELECTION INDICATOR – LED indicator showing input selection to ZONE 1 mix bus.

⑧ Z2 SELECTION INDICATOR – LED indicator showing input selection to ZONE 2 mix bus.

3.2 Output Section

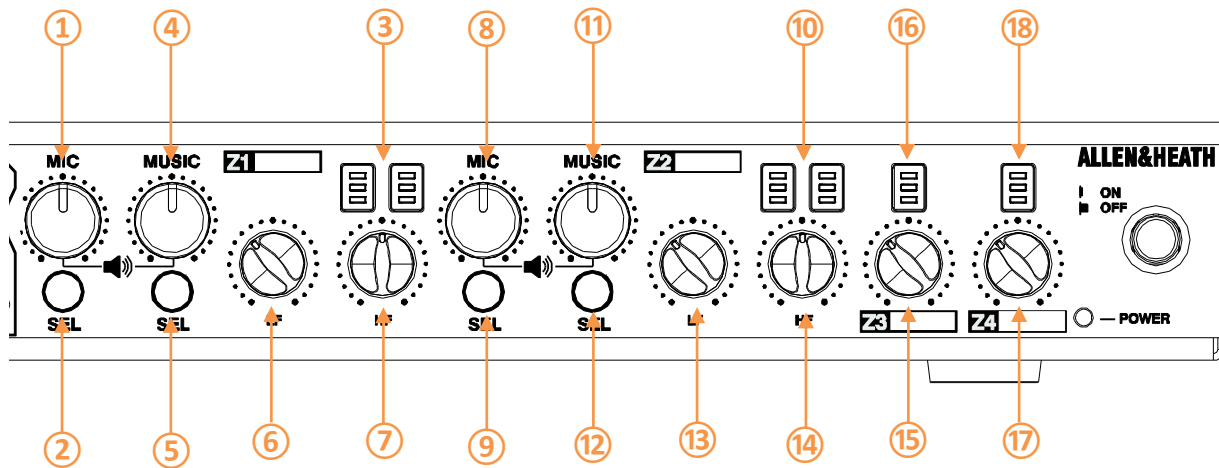

① Z1 MIC MIX OUTPUT LEVEL – Adjustable rotary level control for MIC Mix to Zone 1. Output level control Off to +6dB.

② Z1 MIC SELECT SWITCH – Output Zone Mic selection switch used to add/remove mic sources to/from the output Zone 1 mix signal. The following combinations are supported; Mic 1 only/Mics 2-4 only/All Mics

③ Z1 OUTPUT METER - Three-segment LED meter showing L & R output level of Z1 Mix. Illumination will occur at -18, +3 and +17dB.

④ Z1 MUSIC OUTPUT LEVEL – Adjustable rotary level control of Stereo sources to Zone 1. Output level control Off to +6dB.

⑤ Z1 MUSIC SELECT SWITCH – Output Zone Music selection switch used to select Stereo sources to output Zone 1 mix.

⑥ Z1 OUTPUT EQ – LF control of Zone 1 output signal. Shelving EQ with +/-15dB with cut-off frequency at 80Hz.

⑦ Z1 OUTPUT EQ – HF control of Zone 1 output signal. Shelving EQ with +/-15dB with cut-off frequency at 8kHz.

⑧ Z2 MIC MIX OUTPUT LEVEL – Adjustable rotary level control for MIC Mix to Zone 2. Output level control Off to +6dB.

⑨ Z2 MIC SELECT SWITCH – Output Zone Mic selection switch used to add/remove mic sources to/from the output Zone 2 mix signal. The following combinations are supported; Mic 1 only/Mics 2-4 only/All Mics.

⑩ Z2 OUTPUT METER - Three-segment LED meter showing L & R output level of Zone 2 Mix. Illumination will occur at -18, +3 and +17dB.

⑪ Z2 MUSIC OUTPUT LEVEL – Adjustable rotary level control of Stereo sources to Zone 2. Output level control Off to +6dB.

⑫ Z2 MUSIC SELECT SWITCH – Output Zone Music selection switch used to select Stereo sources to output Zone 2 mix

⑬ Z2 OUTPUT EQ – LF control of Zone 2 output signal. Shelving EQ with +/-15dB with cut-off frequency at 80Hz.

⑭ Z2 OUTPUT EQ – HF control of Zone 2 output signal. Shelving EQ with +/-15dB with cut-off frequency at 8kHz.

⑮ Z3 MIX OUTPUT LEVEL – Adjustable rotary level control of Mix to Zone 3. Output level control Off to +6dB.

16 Z3 OUTPUT METER - Three-segment LED meter showing mono output level of Zone 3 Mix. Illumination will occur at -18, +3 and +17dB.

18 Z4 OUTPUT METER - Three-segment LED meter showing mono output level of Zone 4 Mix. Illumination will occur at -18, +3 and +17dB.

17 Z4 MIX OUTPUT LEVEL – Adjustable rotary level control of Mix to Zone 4. Output level control Off to +6dB.

3.3 General

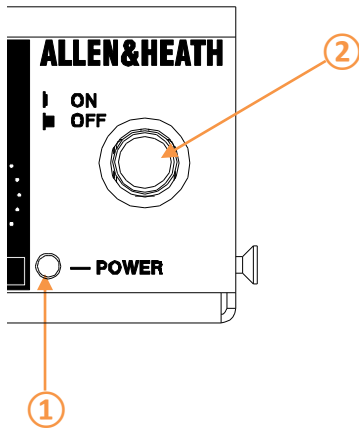

1 POWER INDICATOR – LED indicator showing the unit has power. Also used to indicate when unit is in 'Programming' mode (see section 6.4).

2 MAINS SWITCH – Switch to power the unit ON/OFF.

Note: The mains button can be removed and replaced with a blanking bung to avoid accidental powering off of the unit.

4 Rear Panel

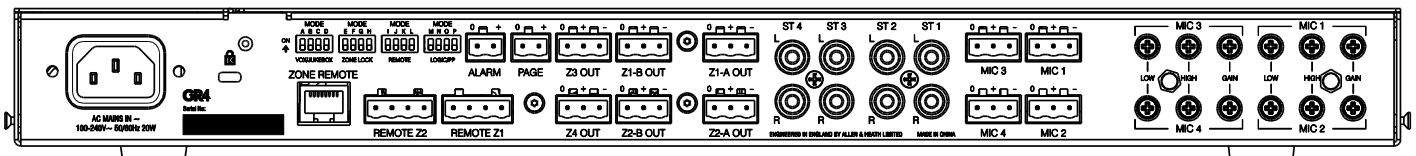

4.1 General

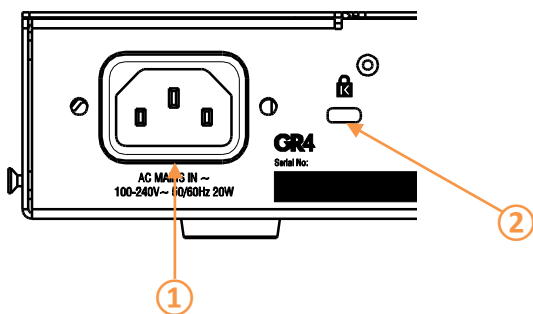

1 AC POWER

IEC receptacle to connect mains power cable (included). 100V to 240V accepted.

2 KENSINGTON LOCK

Kensington lock cut-out for securing unit.

4.2 Control Section

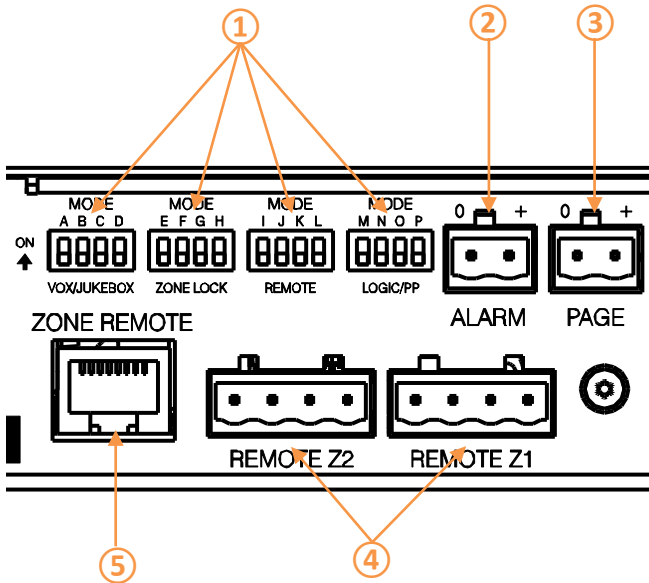

① DIP SWITCHES

Dip switches used to control priority settings, zone lock, remote operation and contact closure configuration.

(See section 6.3 for detailed description).

② ALARM INPUT

Contact closure (DIP switch option for Normally Open/Closed) for emergency input detect. On activation all inputs will fade to the pre-set level except for Mic 1 and Z1 & Z2 LED's will flash quickly. Normal operation will resume once contact is reset to original state.

③ PAGE INPUT

Contact closure (DIP switch option for Normally Open/Closed) for paging announcements. On activation all inputs will fade to the pre-set level except for Mic 1 and Z1 & Z2 LED's will flash slowly. Normal operation will resume once contact is reset to original state.

④ ANALOGUE ZONE REMOTE

4-pole Euroblock connector for connection of custom or 3rd party volume and/or source selection panels.

(See section 6.6 for detailed description).

⑤ DIGITAL ZONE REMOTE

RJ45 connector for use with the Allen & Heath PL-14 remote controller.

(See section 6.6 for detailed description).

4.3 Output Section

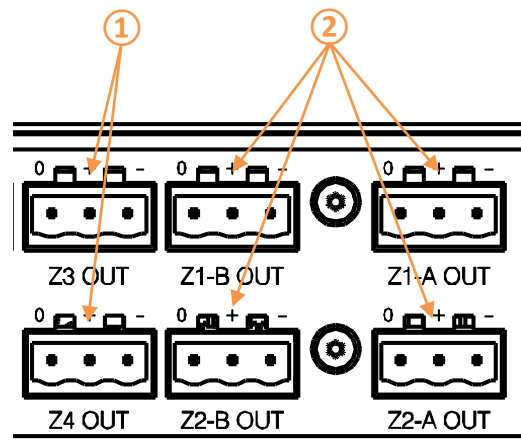

① Z3 & Z4 OUTPUTS

Mono, balanced zone outputs on Euroblock connector.

② Z1 & Z2 OUTPUTS

Stereo (mono configurable via internal jumpers) balanced outputs on Euroblock connector.

4.4 Input Section

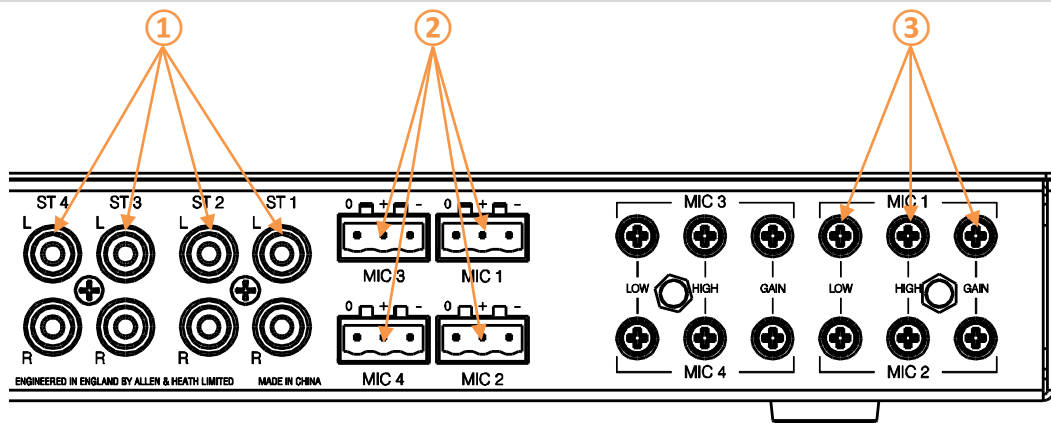

① STEREO INPUTS

Line level inputs 1 to 4 on unbalanced phono connectors.

Note: Unloaded Phono connectors can induce noise on the output if the input level is not on the fully off position. Either ensure unused channels have Zero Gain/Level or use termination connectors on unused inputs.

② MIC INPUTS

Microphone input on balanced Euroblock connector.

Note: Mic 1 is selectable between rear Euroblock and front mount XLR via front mount switch.

③ MIC INPUT ADJUSTMENT

Microphone gain, Lo and Hi EQ trim pots used to adjust the input sensitivity of the pre-amplifier channel* and to adjust the EQ setting of the MIC channel.

*Setting the channel gain

1. Connect the microphone to be used with the associated input.
2. Speak into the microphone whilst adjusting the gain trim with a small flat blade screwdriver.
3. Adjust the trim until the Hi Lev LED illuminates and then trim back the level slightly so it no longer illuminates.
4. Further adjustments may be required to suit the dynamics of the users' normal range.

5 Installing GR4

5.1 Mounting the unit

The GR4 can be used as a stand-alone unit and placed on a hard surface or rack-mounted in a standard 1U 19" profile.

You will need the following items;

- T8 Torx screwdriver
- Small flat blade screwdriver
- Rack ears (supplied)
- 4 x M3 Torx screws (supplied)
- Posi Screwdriver
- 4 x M6 Screws

To rack-mount the unit follow the below procedure;

1. Using the supplied rack ears and M3 Torx screws fit to the unit as in the below diagram.

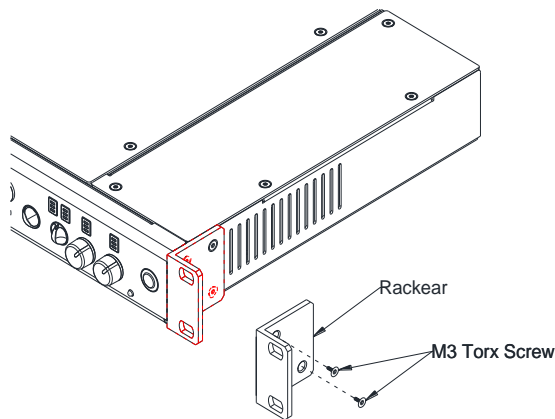

Be sure to use the supplied screws or exact replacements (damage to internal PCB's can result when using longer screws).

2. Using the small flat bladed screwdriver gently remove the four rubberized feet on the base of the unit.

Gently prize the central plastic grommet away from the unit. Once removed the rubberized feet can be stored safely for future use.

To reinstate simply push the grommet into place.

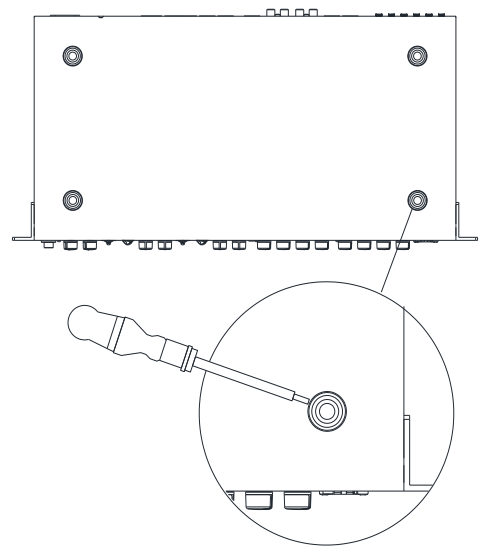

3. Install within the 19" rack making sure the unit is secure.

Please ensure you have enough depth within the rack to accommodate the GR4 together with sufficient cable bending radius (the GR4 is 220mm deep).

Note: Please ensure adequate ventilation is provided and the sides of the unit are not obstructed to maintain adequate airflow.

6 Connecting to GR4

6.1 Microphone Inputs

Microphone inputs are balanced connections on Euroblock type connectors.

Pin assignments are screen printed above the connector or alternatively use the below wiring diagram.

Refer to 4.4 Input Section ② for location details

XLR to Euroblock (Balanced to Balanced)

0 = Screen (Pin 1)

+ = Hot (Pin 2)

- = Cold (Pin 3)

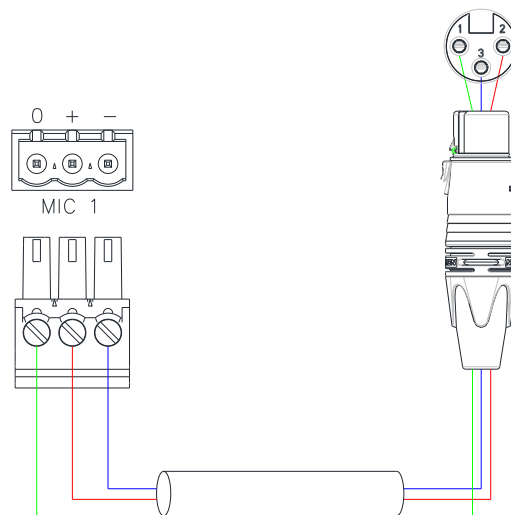

Balanced microphone input wiring example.

6.2 Stereo Inputs

Line level stereo inputs are unbalanced on RCA connectors.

Refer to 4.4 Input Section ① for location details

RCA to RCA (Unbalanced to Unbalanced)

Tip = Tip

Sleeve = Sleeve

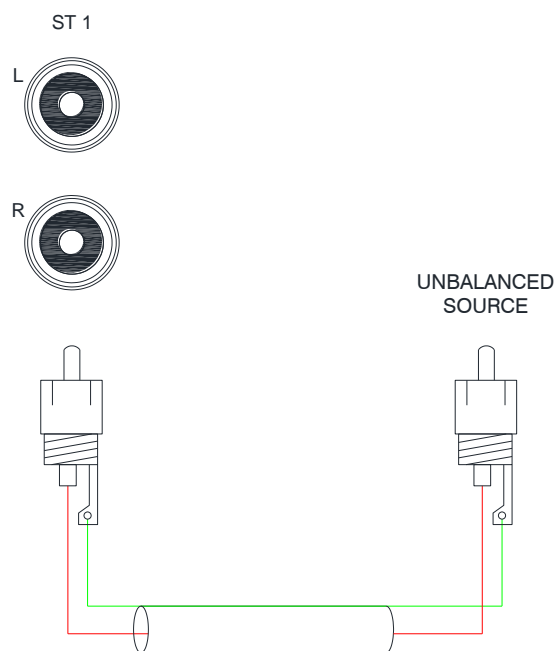

Unbalanced line input wiring example.

XLR/Euroblock (Transformer or Cross-Coupled Output) to RCA

- Screen (Pin 1) = Link to Pin 3
- Hot (Pin 2) = Tip
- Cold (Pin 3) = Sleeve

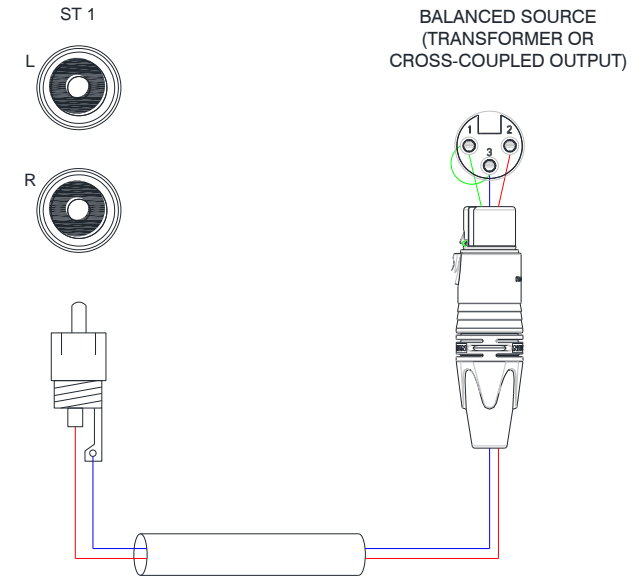

Balanced to Unbalanced input wiring example.

6.3 Zone Outputs

Zone outputs are balanced connections on Euroblock type connectors.

Pin assignments are screen printed above the connector or alternatively use the below wiring diagrams.

Refer to 4.3 Output Section [1](#) for location details

Euroblock to XLR (Balanced to Balanced)

- 0 = Screen
- + = Hot
- = Cold

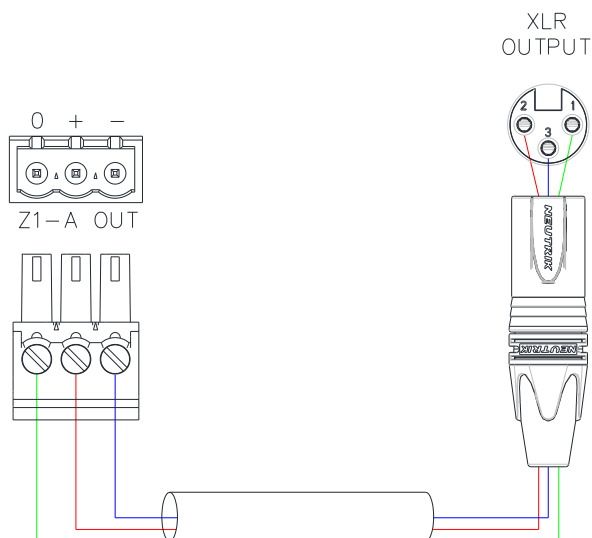

Balanced line output (XLR) wiring example.

Euroblock to TRS (Balanced to Balanced)

- 0 = Sleeve
- + = Tip
- = Ring

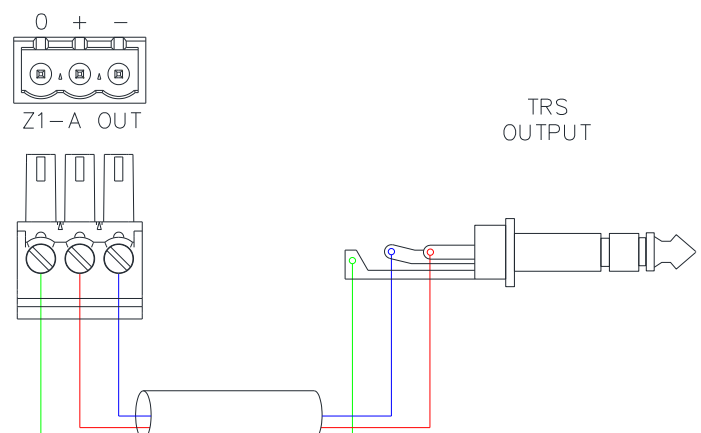

Balanced line output (TRS) wiring example.

Euroblock to RCA (Balanced to Unbalanced)

- 0 = Link to Negative
- + = Tip
- = Sleeve

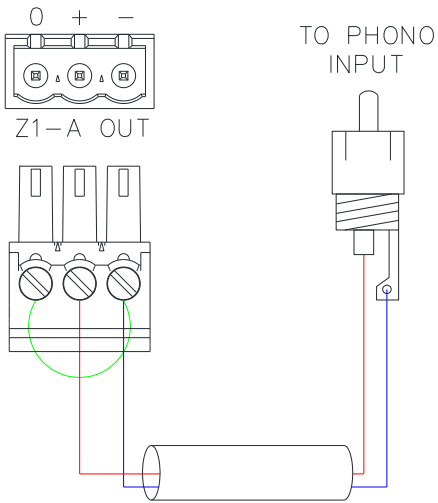

Balanced line output (Phono) wiring example.

6.4 Alarm Input

The Alarm input is a 2-pole connection on Euroblock type connector and is typically configured to the Normally Closed contacts. Pin assignments are screen printed above the connector or alternatively use the below wiring diagrams.

Refer to 4.2 Control Section [2](#) for location details

2-Wire Alarm Contact Closure

- 0 = COM
- + = N/O (or N/C)

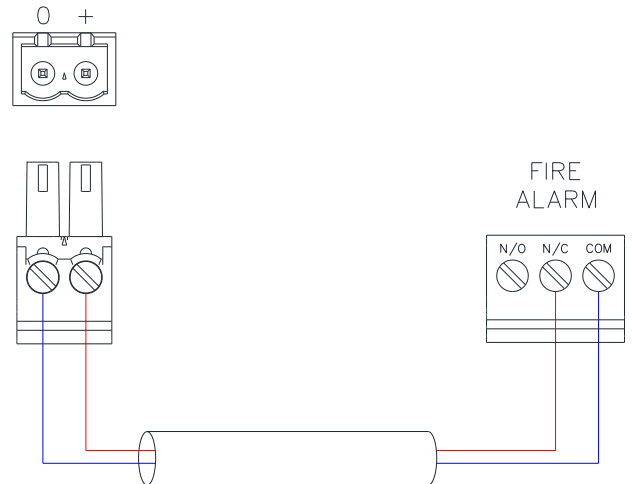

2-wire contact example.

6.5 Page Input

The Page input is a 2-pole connection on Euroblock type connector and is typically configured to the Normally Open contacts. Pin assignments are screen printed above the connector or alternatively use the below wiring diagrams.

Refer to 4.2 Control Section **3** for location details

2-Wire Paging Switch

0 = COM

+ = N/O (or N/C)

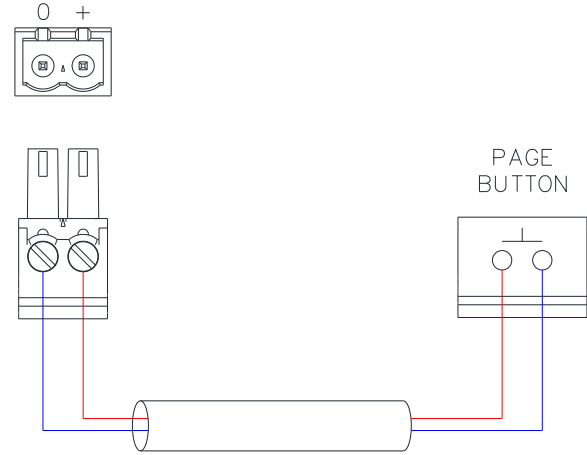

2-wire switch example.

6.6 Remote Connection

There are two methods for connecting a remote control to the GR4. Remote control is enabled via the rear mount dip switches.

Digital Remote Connection

The RJ45 “ZONE REMOTE” port allows for the connection of the Allen & Heath PL-14 remote controllers. A maximum of two PL-14’s can be connected in daisy-chain wiring with various control options depending on installation requirements (see PL-14 manual for additional details regarding cable types and length).

Refer to 4.2 Control Section **5** for location details

 Do not connect remote port to anything other than the designated remote controller.

Digital Remote (RJ45 to RJ45)

1 = White/Orange

2 = Orange

3 = White/Green

4 = Blue

5 = White/Blue

6 = Green

7 = White/Brown

8 = Brown

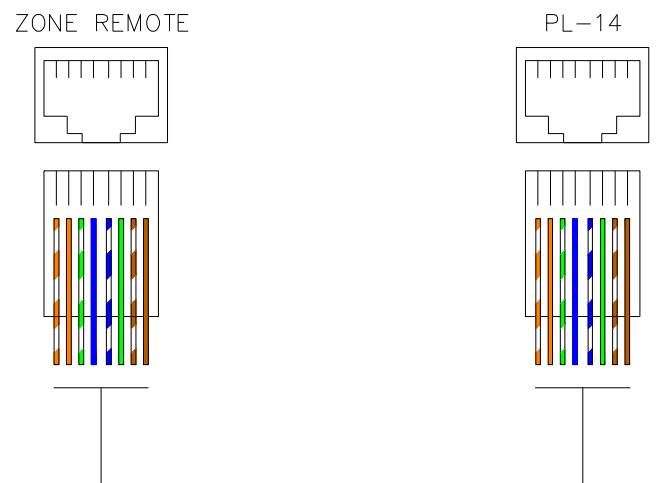

RJ45 Wiring Example using TIA/EIA 568B standard.

Analogue Remote Connection

The analogue inputs are 4-pole Euroblock type connectors for Zone 1 & Zone 2 control. These are 0-10V inputs and are typically used as a variable resistance and stepped voltage control for analogue volume control and source selection.

Pin assignments are screen printed above the connector or alternatively use the below wiring diagrams.

Refer to 4.2 Control Section [4](#) for location details

4-Wire Analogue Remote

0 = 0V
L = Level
S = Source
+ = 10V

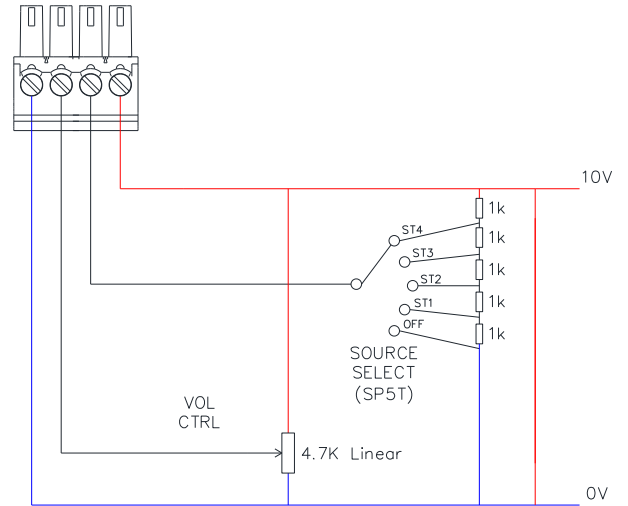
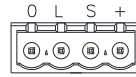

Analogue remote connection example.

7 Setting up GR4

7.1 Operating Features

The GR4 is a feature rich analogue zone mixer. Multiple configurations are possible by means of internal jumpers, external dip switches and also via digital programmable pre-sets.

The below gives an overview of the various Modes that the GR4 enters when signal is sensed on various input connectors.

Primary Mic Mode: When audio sensed on Mic 1 channel and/or PAGE contact closure is sensed then music is faded to pre-set level and Mic 2 muted for the duration of the announcement. Mic 1 zone select LEDs flash slowly when in primary mic mode.

Secondary Mic Mode: When audio is sensed on Mic 2, then music is faded to pre-set level for the duration of the announcement. Mic 2 zone select LEDs flash slowly when in secondary mic mode.

Emergency Mic Mode: When ALARM contact is activated all zone feeds are muted and Mic 1 is fed direct to all zones. All select LEDs except Mic 1 LED are switched off for the duration. Mic 1 LED will flash quickly.

Juke Box Mode: Is a priority Music feed. When in Jukebox mode and audio is sensed on ST3 the current music feed will 'duck'* to the pre-set level. If ST3 is silent for the pre-set period, the previous Music selection will resume. Mic volume is not affected by Jukebox priority.

**Pre-set levels for the above modes are achieved via a side-chain compressor or 'ducker'. A ducker is dynamic control of Input x by input y which has a higher priority. If audio is detected at Input y then Input x will be 'Ducked' by a predetermined level which can be set by the user (see Table 1 6.4 for user definable parameters). In addition to the amount of attenuation is applied to the*

'Ducked' signal the user can also control the hold time and release time of the compressor to suit the application.

7.2 Internal Jumper Settings



Please ensure that unit is switched off before changing any jumper settings. Ensure necessary precautions have been taken prior to removal of cover. If in doubt call an experienced engineer.

Warning: Do not remove PSU cover. If in doubt call an experienced engineer.

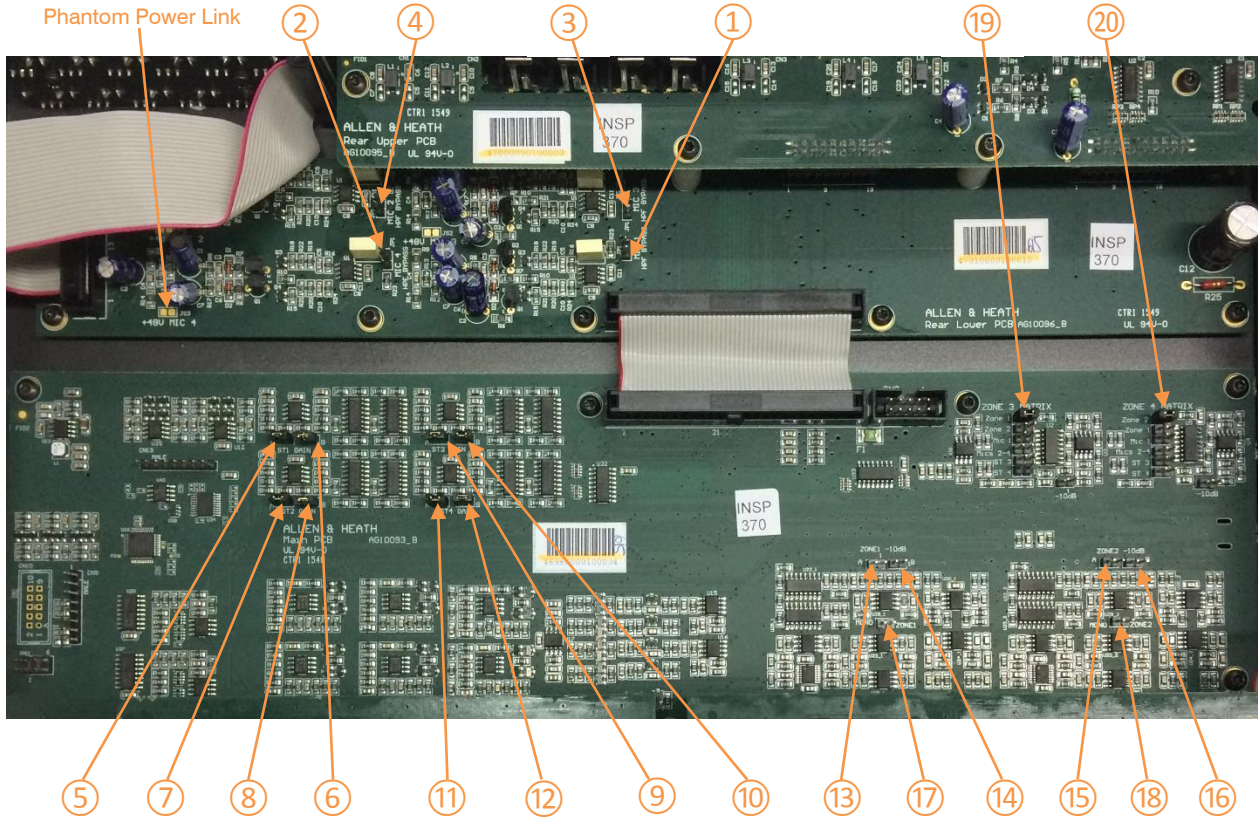

Jumper	Function	State when Jumper fitted	State when Jumper not fitted (Default)
①	MIC 1 High Pass Filter @ 150Hz	Filter Inactive	Filter active
②	MIC 2 High Pass Filter @ 150Hz	Filter Inactive	Filter active
③	MIC 3 High Pass Filter @ 150Hz	Filter Inactive	Filter active
④	MIC 4 High Pass Filter @ 150Hz	Filter Inactive	Filter active
⑤	ST1 L Gain	+10dB	0dB
⑥	ST1 R Gain	+10dB	0dB
⑦	ST2 L Gain	+10dB	0dB
⑧	ST2 R Gain	+10dB	0dB
⑨	ST3 L Gain	+10dB	0dB
⑩	ST3 R Gain	+10dB	0dB
⑪	ST4 L Gain	+10dB	0dB
⑫	ST4 R Gain	+10dB	0dB
⑬	Zone 1 A Gain	-10dB	+4dBu
⑭	Zone 1 B Gain	-10dB	+4dBu
⑮	Zone 2 A Gain	-10dB	+4dBu
⑯	Zone 2 B Gain	-10dB	+4dBu
⑰	Zone 1 Mono	Zone 1 mono output	Zone 1 stereo output
⑱	Zone 2 Mono	Zone 2 mono output	Zone 2 stereo output
⑲	Zone 3 Mix	Multiple Configurations (see matrix p18)	No output
⑳	Zone 4 Mix	Multiple Configurations (see matrix p18)	No output

Zone 3 & 4 are mixed from a matrix on internal jumpers. The unit is shipped with the below settings as default but both zones can have any number of jumpers applied to suit the application.

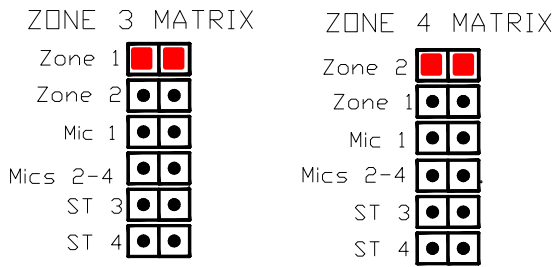

Zone 3 & 4 Matrix Mix Default Positions

7.3 Dip Switch Settings

There are 16 Rear mounted DIP switches for selecting various options.

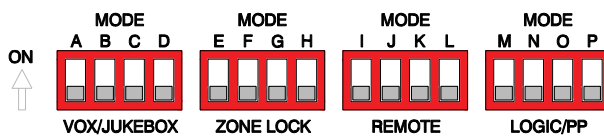

DIP switch settings Up = ON. Factory default = all switches down (OFF).

A	Mic 1 Level Paging Detect	Switches Primary Mic mode (ON)
B	Mic 2-4 Level Paging Detect	Switches Secondary Mic mode (ON)
C	Jukebox Mode Z1	Switches Jukebox mode in Zone 1 (ON)
D	Jukebox Mode Z2	Switches Jukebox mode in Zone 2 (ON)
E	Z1 Mic Select Lock	Locks the front MIC SEL switch for Z1 (ON)
F	Z1 Music Select Lock	Locks the front MUSIC SEL switch for Z1 (ON)
G	Z2 Mic Select Lock	Locks the front MIC SEL switch for Z2 (ON)
H	Z2 Music Select Lock	Locks the front MUSIC SEL switch for Z2 (ON)
I	Z1 Volume Local/Remote Control	Enables Z1 remote volume control (ON)
J	Z1 Stereo Input Local/Remote Control	Enables Z1 remote source select (ON)
K	Z2 Volume Local/Remote Control	Enables Z2 remote volume control (ON)
L	Z2 Stereo Input Local/Remote Control	Enables Z2 remote source select (ON)
M	PAGE logic invert	Normally Open (OFF) Normally Closed (ON)
N	ALARM logic invert	Normally Open (OFF) Normally Closed (ON)
O	Phantom Power Enable Mic 1	Enables Phantom Power MIC 1 (ON)
P	Phantom Power Enable Mics 2-4	Enables Phantom Power MICS 2-4* (ON)

**Phantom Power for individual mics can be disconnected via an internal link (as shown in internal jumper diagram)
Please ensure mic levels are fully attenuated prior to engaging phantom power.*



7.4 Programming Parameters

The GR4 has a total of 7 parameters (shown in Table 1) which are configurable by the installer/user.

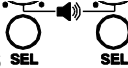

Each parameter has four pre-defined values which can be stepped through and set as required.

Changing a Parameter Step by Step Guide- Ensure amplifiers/powerd speakers are switched off prior to powering the unit up or down.

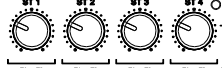

To enter Programming Mode;

1. Press and hold Z1 Mic & Music “SEL” switches  whilst powering on the GR4  GR4
2. Power LED  will flash continuously whilst in Programming Mode.

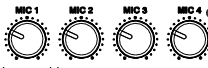
Changing a parameter;

1. Use Z2 Mic & Music “SEL” switches  to toggle through the parameter to change  as shown in Table 1.
2. Use Z1 Mic & Music “SEL” switches  to toggle through the value required  as shown in Table 1.
3. The new parameter value is stored automatically. The parameter LED will flash quickly during the save procedure.

Exit Programming Mode;

1. Power cycle the unit  to return to normal operation, LED will remain solid 

Parameter	Value	1	2	3	4
	LED	MIC1 Z1	MIC1 Z2	MIC2-4 Z1	MIC2-4 Z2
1 Ducker Attenuation	ST1 Z1	-12dB	-20dB	-30dB	OFF
2 Ducker Hold Time	ST1 Z2	500mS	1.5s	5s	10s
3 Ducker Release Time	ST2 Z1	500mS	1.5s	5s	20s
4 Music Crossfade Time	ST2 Z2	50mS	200mS	500mS	3s
5 Jukebox Attack Time	ST3 Z1	50mS	200mS	500mS	1s
6 Jukebox Hold Time	ST3 Z2	1s	3s	5s	20s
7 Jukebox Release Time	ST4 Z1	500mS	1.5s	3s	10s

Table 1 – Showing Parameter/Value/LED State matrix. (Factory settings highlighted).

8 FAQ

Q: What are the main differences between the GR4 and GR2?

A: The GR4 has an additional stereo zone output together with two additional mono zone outputs which can be individually set to one of six pre-set mixes. Each microphone input has individual tone control. Additional connectors have been added to the front panel in the form of an XLR Mic input for priority announcements and a 3.5mm socket has been added for connection of MP3 players. The ability to control the mix of mic and music sources on zone outputs 1 & 2.

Q: My audio sources keep fading in and out?

A: It is likely that one or more dip switches have been set to the “ON” position. The GR4 has various “MODES” that allow priority control of the incoming signals.

- **Primary Mic Mode (Dip Switch A).** This will automatically mute mics 2-4 and fade the music sources to a pre-defined level.
- **Secondary Mic Mode (Dip Switch B).** This will automatically fade the music sources to a pre-defined level.
- **Jukebox Mode (Dip Switch C & D).** This will fade down the music on all stereo inputs except for ST3 which is set as the Jukebox priority input.

Q: Can I control the unit over a standard network?

A: No, the rear RJ45 port is for use with Zone remote panels only and is not intended for connection to a network switch.

Q: How do I control the unit remotely?

A: Remote control can be achieved by either using the optional Allen & Heath PL-14 controller or via custom wired control. The “ZONE REMOTE” RJ45 port on the rear of the unit will accept up to two PL-14's which are

connected in a ‘daisy-chain’ configuration. An optional PL-5 remote is also available for Infrared control of the PL-14. Alternatively a custom or 3rd party 0-10v controller can be wired to the “REMOTE Z1” and/or “REMOTE Z2” connectors on the rear of the unit.

Q: I want to change some of the processors software parameters?

A: These options can be accessed by holding down Z1 select buttons whilst powering the unit.

- Mic ducking attenuation, hold and release speeds.
- Music cross fade speed.
- Juke box attack, hold and release speed.

Q: Can I change the routing options to Zones 3 & 4?

A: Yes, Zones 3 & 4 are factory set to output the mix of Zone 1 & 2 respectively. Utilising one or a multiple of the internal jumpers it is possible to create an entirely independent mix on both Zone 3 & 4. The jumper options are as below.

- **Jumper 1 (Default)** – Zone 1 mix (Zone 2 mix is default for Zone 4)
- **Jumper 2** – Zone 2 mix (Zone 1 mix for Zone 4)
- **Jumper 3** – Mic 1 only (for both Zone 3 & 4)
- **Jumper 4** – Mics 2-4 only (for both Zone 3 & 4)
- **Jumper 5** – ST3 only (for both Zone 3 & 4)
- **Jumper 6** – ST4 only (for both Zone 3

9 Block Diagram

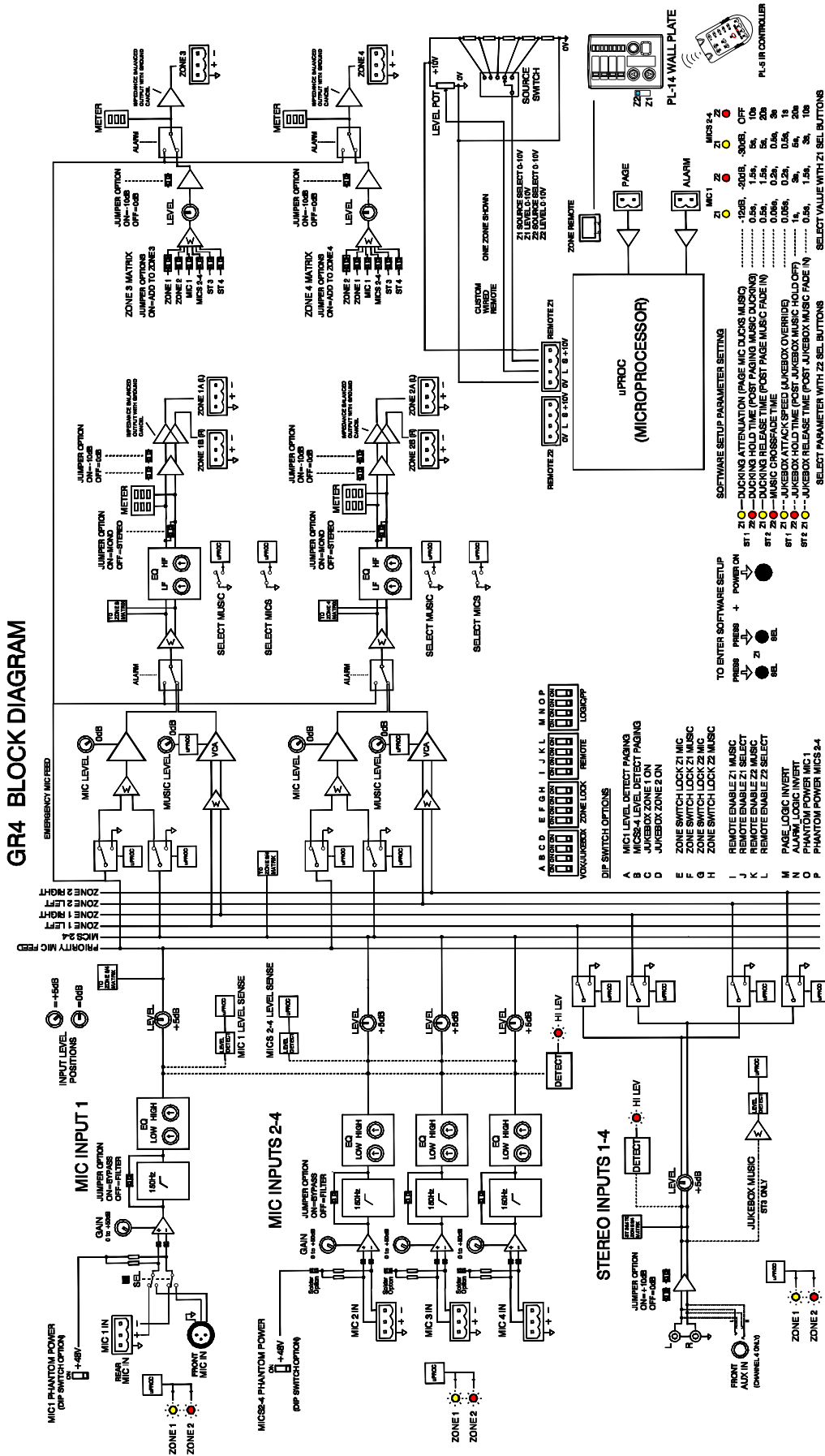

10 Specifications

Microphone Inputs		
Mic Input Sensitivity (Gain = Min)		0dBu
Mic Input Sensitivity (Gain = Max)		-50dBu
Mic Level control (Max)		+6dB
Mic Level control (Min)		OFF
Mic HPF -3dB		150Hz
Mic EQ LF		+/- 15dB fc = 60Hz
Mic EQ HF		+/-15dB fc = 9kHz
Mic Frequency Response 20Hz – 20kHz		+/-1dB
Mic THD+n @0dBu in 1kHz		0.004% 22-22kHz
Mic THD+n @-30dBu in 30dB gain 1kHz		0.005% 22-22kHz
Mic Hi Level warning LED (Unity gain)		+18dBu
Clip level (Unity gain)		+21dBu
Mic EIN@50dB Gain		-127dB
Stereo Inputs		
ST Input Sensitivity (Gain link OFF)		0dBu
ST Input Sensitivity (Gain Link ON)		-10dBu
ST Level control (Max)		+6dB
ST Level control (Min)		OFF
Max Line Input		+18dBu
ST Frequency response 20Hz – 20kHz		+/-0.5dB
ST THD+n @-10dBu in 1kHz		0.015% 22-22kHz
ST THD+n @0dBu in 1kHz		0.035% 22-22kHz
Crosstalk from unselected channel		-75dB @ 1kHz
Zone Outputs		
Nominal Zone Level		0dBu (-10dBu with optional jumper)
Main Zone Level control (Max)		0dB
Main Zone Level control (Min)		OFF
Main Zone 3 Segment LED Meter		-18/+3/+17dBu
Main Zone EQ LF		+/-15dB fc = 60Hz
Main Zone EQ HF		+/-15dB fc = 9kHz
Main Zone Clip level (Unity gain)		+21dBu
Alarm/Page Inputs		
Max/Min Voltage		+15/-15V
Input source/sink		Max 5mA
Off Threshold		<0.2V
On Threshold		>1V
Noise		
ST Input to Main Zone output (Unity)		-90dBu 22-22kHz
Mic Input routed at Min gain		-88dBu 22-22kHz
Mic Input routed at Max gain		-77dBu 22-22kHz (150R source)
Power Consumption		
GR4 unit (no remote attached)		15W
Loaded Power (Max)		20W
Weights & Dimensions		
	Unboxed	Boxed
Height	48mm (1.9")	200mm(7.9")
Length	242mm (9.5")	340mm(13.4")
Width	438mm (17.2")	530mm(20.9")
Weight	3.4kg (7.5lbs)	4kg (8.8lbs)

11 Connection Diagram

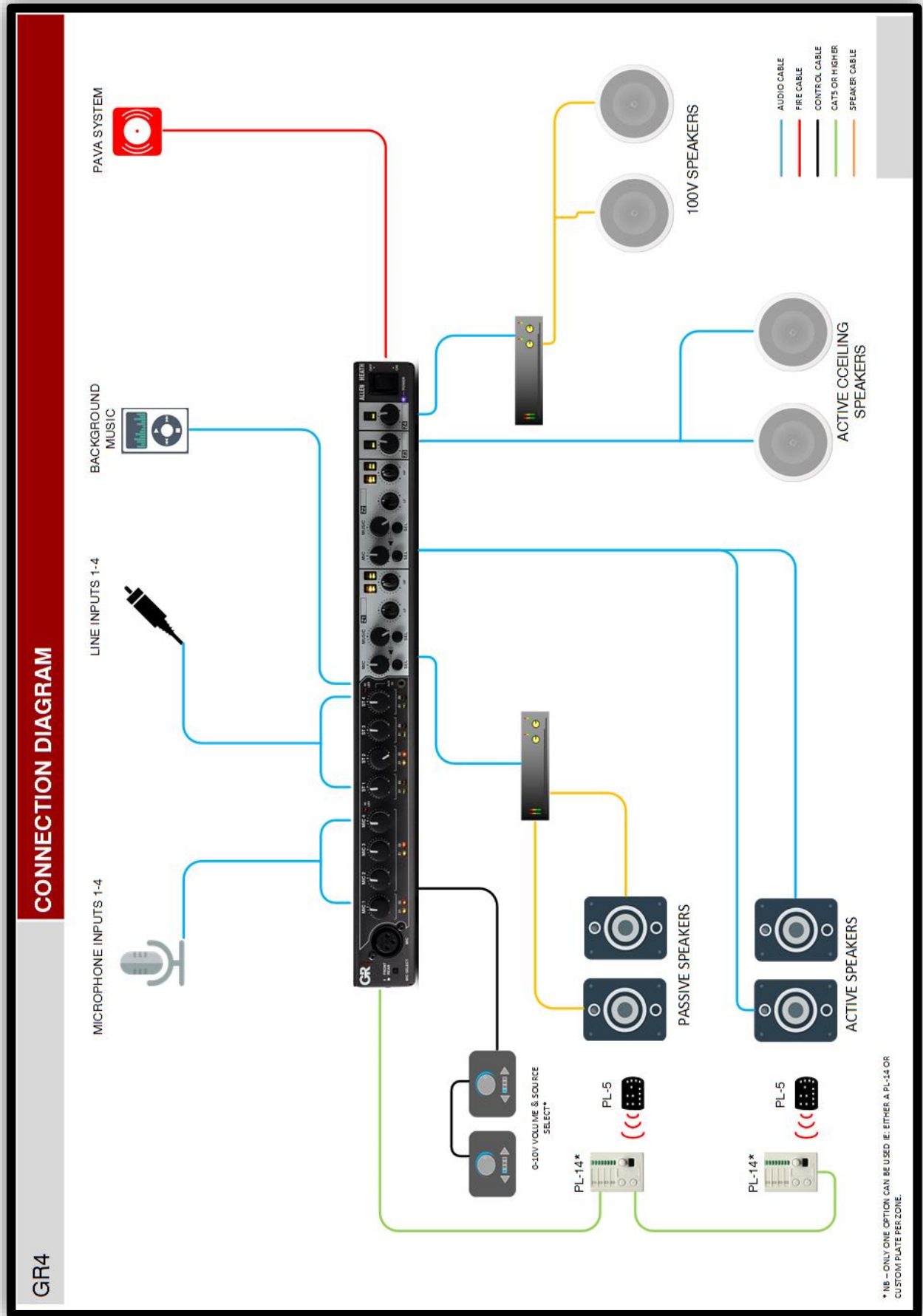

12 Application Examples

