



POWERED MIXER

EMX5

Owner's Manual

Contents

 page 5

If you wish to get started right away:

 pages 6 to 9 Quick Start Guide

If you encounter a problem:

 page 13 Troubleshooting

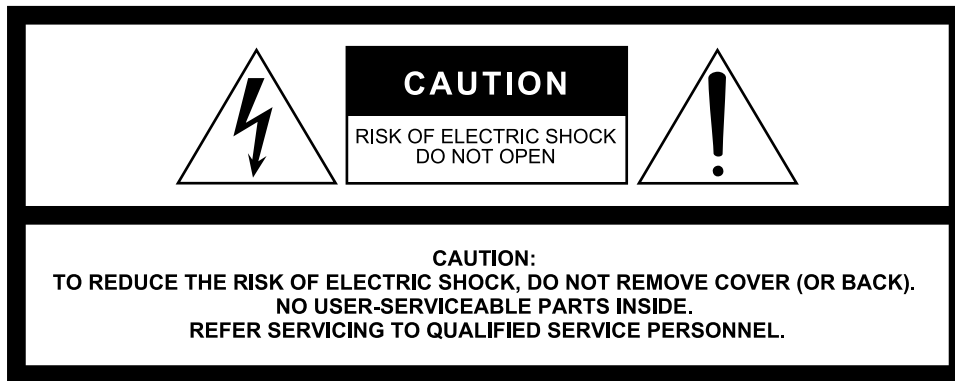

The above warning is located on the rear of the unit.
L'avertissement ci-dessus est situé sur l'arrière de l'unité.

IMPORTANT SAFETY INSTRUCTIONS

- 1 Read these instructions.
- 2 Keep these instructions.
- 3 Heed all warnings.
- 4 Follow all instructions.
- 5 Do not use this apparatus near water.
- 6 Clean only with dry cloth.
- 7 Do not block any ventilation openings. Install in accordance with the manufacturer's instructions.
- 8 Do not install near any heat sources such as radiators, heat registers, stoves, or other apparatus (including amplifiers) that produce heat.
- 9 Do not defeat the safety purpose of the polarized or grounding-type plug. A polarized plug has two blades with one wider than the other. A grounding type plug has two blades and a third grounding prong. The wide blade or the third prong are provided for your safety. If the provided plug does not fit into your outlet, consult an electrician for replacement of the obsolete outlet.
- 10 Protect the power cord from being walked on or pinched particularly at plugs, convenience receptacles, and the point where they exit from the apparatus.
- 11 Only use attachments/accessories specified by the manufacturer.
- 12 Use only with the cart, stand, tripod, bracket, or table specified by the manufacturer, or sold with the apparatus. When a cart is used, use caution when moving the cart/apparatus combination to avoid injury from tip-over.
- 13 Unplug this apparatus during lightning storms or when unused for long periods of time.
- 14 Refer all servicing to qualified service personnel. Servicing is required when the apparatus has been damaged in any way, such as power-supply cord or plug is damaged, liquid has been spilled or objects have fallen into the apparatus, the apparatus has been exposed to rain or moisture, does not operate normally, or has been dropped.



WARNING

TO REDUCE THE RISK OF FIRE OR ELECTRIC SHOCK, DO NOT EXPOSE THIS APPARATUS TO RAIN OR MOISTURE.

(UL60065_03)

Explanation of Graphical Symbols Explication des symboles

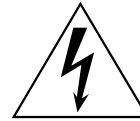

The lightning flash with arrowhead symbol within an equilateral triangle is intended to alert the user to the presence of uninsulated "dangerous voltage" within the product's enclosure that may be of sufficient magnitude to constitute a risk of electric shock to persons.

L'éclair avec une flèche à l'intérieur d'un triangle équilatéral est destiné à attirer l'attention de l'utilisateur sur la présence d'une « tension dangereuse » non isolée à l'intérieur de l'appareil, pouvant être suffisamment élevée pour constituer un risque d'électrocution.



The exclamation point within an equilateral triangle is intended to alert the user to the presence of important operating and maintenance (servicing) instructions in the literature accompanying the product.

Le point d'exclamation à l'intérieur d'un triangle équilatéral est destiné à attirer l'attention de l'utilisateur sur la présence d'instructions importantes sur l'emploi ou la maintenance (réparation) de l'appareil dans la documentation fournie.

PRÉCAUTIONS CONCERNANT LA SÉCURITÉ

- 1 Lire ces instructions.
- 2 Conserver ces instructions.
- 3 Tenir compte de tous les avertissements.
- 4 Suivre toutes les instructions.
- 5 Ne pas utiliser ce produit à proximité d'eau.
- 6 Nettoyer uniquement avec un chiffon propre et sec.
- 7 Ne pas bloquer les orifices de ventilation. Installer l'appareil conformément aux instructions du fabricant.
- 8 Ne pas installer l'appareil à proximité d'une source de chaleur comme un radiateur, une bouche de chaleur, un poêle ou tout autre appareil (y compris un amplificateur) produisant de la chaleur.
- 9 Ne pas modifier le système de sécurité de la fiche polarisée ou de la fiche de terre. Une fiche polarisée dispose de deux broches dont une est plus large que l'autre. Une fiche de terre dispose de deux broches et d'une troisième pour le raccordement à la terre. Cette broche plus large ou cette troisième broche est destinée à assurer la sécurité de l'utilisateur. Si la fiche équipant l'appareil n'est pas compatible avec les prises de courant disponibles, faire remplacer les prises par un électricien.
- 10 Acheminer les cordons d'alimentation de sorte qu'ils ne soient pas piétinés ni coincés, en faisant tout spécialement attention aux fiches, prises de courant et au point de sortie de l'appareil.
- 11 Utiliser exclusivement les fixations et accessoires spécifiés par le fabricant.
- 12 Utiliser exclusivement le chariot, le stand, le trépied, le support ou la table recommandés par le fabricant ou vendus avec cet appareil. Si l'appareil est posé sur un chariot, déplacer le chariot avec précaution pour éviter tout risque de chute et de blessure.
- 13 Débrancher l'appareil en cas d'orage ou lorsqu'il doit rester hors service pendant une période prolongée.
- 14 Confier toute réparation à un personnel qualifié. Faire réparer l'appareil s'il a subi tout dommage, par exemple si la fiche ou le cordon d'alimentation est endommagé, si du liquide a coulé ou des objets sont tombés à l'intérieur de l'appareil, si l'appareil a été exposé à la pluie ou à de l'humidité, si l'appareil ne fonctionne pas normalement ou est tombé.



AVERTISSEMENT

POUR RÉDUIRE LES RISQUES D'INCENDIE OU DE DÉCHARGE ÉLECTRIQUE, N'EXPOSEZ PAS CET APPAREIL À LA PLUIE OU À L'HUMIDITÉ.

(UL60065_03)

PRECAUTIONS

PLEASE READ CAREFULLY BEFORE PROCEEDING

Please keep this manual in a safe place for future reference.

WARNING

Always follow the basic precautions listed below to avoid the possibility of serious injury or even death from electrical shock, short-circuiting, damages, fire or other hazards. These precautions include, but are not limited to, the following:

Power supply/power cord

- Do not place the power cord near heat sources such as heaters or radiators, and do not excessively bend or otherwise damage the cord, place heavy objects on it, or place it in a position where anyone could walk on, trip over, or roll anything over it.
- Only use the voltage specified as correct for the device. The required voltage is printed on the name plate of the device.
- Use only the supplied power cord/plug.
If you intend to use the device in an area other than in the one you purchased, the included power cord may not be compatible. Please check with your Yamaha dealer.
- Check the electric plug and each jack periodically, and remove any dirt or dust which may have accumulated. Failure to do so may cause electrical shock, short-circuiting or fire.
- When setting up the device, make sure that the AC outlet you are using is easily accessible. If some trouble or malfunction occurs, immediately turn off the power switch and disconnect the plug from the outlet. Even when the power switch is turned off, as long as the power cord is not unplugged from the wall AC outlet, the device will not be disconnected from the power source.
- Remove the electric plug from the outlet when the device is not to be used for extended periods of time, or during electrical storms.
- Be sure to connect to an appropriate outlet with a protective grounding connection.

Do not open

- This device contains no user-serviceable parts. Do not open the device or attempt to disassemble the internal parts or modify them in any way. If it should appear to be malfunctioning, discontinue use immediately and have it inspected by qualified Yamaha service personnel.

Water warning

- Do not expose the device to rain, use it near water or in damp or wet conditions, or place on it any containers (such as vases, bottles or glasses) containing liquids which might spill into any openings. If any liquid such as water seeps into the device, turn off the power immediately and unplug the power cord from the AC outlet. Then have the device inspected by qualified Yamaha service personnel.
- Never insert or remove an electric plug with wet hands.

Hearing loss

- Avoid setting all equalizer and level controls to their maximum. Depending on the condition of the connected devices, doing so may result in feedback that can cause hearing loss and damage the speakers.
- Do not use speakers for a long period of time at a high or uncomfortable volume level, since this can cause permanent hearing loss. If you experience any hearing loss or ringing in the ears, consult a physician.
- When turning on the AC power in your audio system, always turn on the device LAST, to avoid hearing loss and speaker damage. When turning the power off, the device should be turned off FIRST for the same reason.

Fire warning

- Do not place any burning items or open flames near the device, since they may cause a fire.

If you notice any abnormality

- If any of the following problems occur, immediately turn off the power switch and disconnect the electric plug from the outlet.
 - The power cord or plug becomes frayed or damaged.
 - Unusual smells or smoke are emitted.
 - Some object has been dropped into the device.
 - There is a sudden loss of sound during use of the device.
 - Cracks or other visible damage appear on the device.
 Then have the device inspected or repaired by qualified Yamaha service personnel.

- If this device should be dropped or damaged, immediately turn off the power switch, disconnect the electric plug from the outlet, and have the device inspected by qualified Yamaha service personnel.

CAUTION

Always follow the basic precautions listed below to avoid the possibility of physical injury to you or others, or damage to the device or other property. These precautions include, but are not limited to, the following:

Power supply/power cord

- When removing the electric plug from the device or an outlet, always hold the plug itself and not the cord. Pulling by the cord can damage it.

Location

- Do not place the device in an unstable position where it might accidentally fall over and cause injuries.
- Do not block the vents. This device has ventilation holes at the sides to prevent the internal temperature from becoming too high. In particular, do not place the device on its side or upside down. Inadequate ventilation can result in overheating, possibly causing damage to the device(s), or even fire.
- When using the device:
 - Do not cover it with any cloth.
 - Do not install it on a carpet or rug.
 - Do not use the device in a confined, poorly-ventilated location.

Inadequate ventilation can result in overheating, possibly causing damage to the device(s), or even fire. If this device is to be used in a small space other than an EIA-standard rack, make sure that there is adequate space around the device: at least 30 cm above, 30 cm at the sides and 30 cm behind.

- Do not place the device in a location where it may come into contact with corrosive gases or salt air. Doing so may result in malfunction.
- Before moving the device, remove all connected cables.
- If the device is mounted in an EIA standard rack, carefully read the section "Precautions for Rack Mounting" on page 16. Inadequate ventilation can result in overheating, possibly causing damage to the device(s), malfunction, or even fire.

Connections

- Do not use speaker cables with a metal-housing connector. Doing so may result in electrical shock due to differences in voltage. Use speaker cables with a nonmetal-housing connector, or with a insulated-housing connector.
- Before connecting the device to other devices, turn off the power for all devices. Also, before turning the power of all devices on or off, make sure that all volume levels are set to the minimum. Failing to do so may result in electric shock or equipment damage.
- Use only speaker cables for connecting speakers to the speaker jacks. Use of other types of cables may result in fire.

Maintenance

- Remove the power plug from the AC outlet when cleaning the device.

Handling caution

- Avoid inserting or dropping foreign objects (paper, plastic, metal, etc.) into any gaps or openings on the device (vents, panel, etc.). If this happens, immediately turn off the power, unplug the power cord from the AC outlet, and have the device inspected by qualified Yamaha service personnel.
- Do not rest your weight on the device or place heavy objects on it. Avoid applying excessive force to the buttons, switches or connectors to prevent injuries.

Yamaha cannot be held responsible for damage caused by improper use or modifications to the device.

NOTICE

To avoid the possibility of malfunction/ damage to the product, damage to data, or damage to other property, follow the notices below.

■ Handling and maintenance

- Do not use the device in the vicinity of a TV, radio, AV equipment, mobile phone, or other electric devices. Otherwise, the device, TV, or radio may generate noise.
- Do not expose the device to excessive dust or vibration, or extreme cold or heat (such as in direct sunlight, near a heater, or in a car during the day), in order to prevent the possibility of panel disfiguration, unstable operation, or damage to the internal components.
- Do not place vinyl, plastic or rubber objects on the device, since this might discolor the panel.
- Place input cables for devices such as microphones, and microphone amplifier circuits with high sensitivity in a location that is far away from the speaker cables. In addition, ensure that the power cord is kept at least 1 cm from the speaker cables. Due to an excessively large current flowing through the speaker cables, it may lead to acoustic noise or electromagnetic interference.
- When cleaning the device, use a dry and soft cloth. Do not use paint thinners, solvents, cleaning fluids, or chemical-impregnated wiping cloths.
- Condensation can occur in the device due to rapid, drastic changes in ambient temperature—when the device is moved from one location to another, or air conditioning is turned on or off, for example. Using the device while condensation is present can cause damage. If there is reason to believe that condensation might have occurred, leave the device for several hours without turning on the power until the condensation has completely dried out.
- Do not use the output of this device for any purpose other than driving loudspeakers.
- Always turn the power off when the device is not in use.

■ Connectors

- XLR-type connectors are wired as follows (IEC60268 standard): pin 1: ground, pin 2: hot (+), and pin 3: cold (-).
- Use only Neutrik NL4 plugs for connecting speakON connectors.

Information

■ About this manual

- The illustrations and LCD screens as shown in this manual are for instructional purposes only.
- The company names and product names in this manual are the trademarks or registered trademarks of their respective companies.
- European models
Purchaser/User Information specified in EN55103-2:2009.
Conforms to Environments: E1, E2, E3 and E4
- Information indicated by “NOTE” provides useful tips.

Thank you and congratulations on your purchase of the Yamaha POWERED MIXER EMX5. This product is a powered mixer for mixing multiple sound sources for live performances by a band or other events. This manual helps users not familiar with mixers to install and configure the connections, and also explains how to use the product. Please read this manual thoroughly to get the most out of the product and ensure long-term, trouble-free use. After reading this manual, please keep it available for future reference.

Contents

Main Features	5
Accessories	5
Quick Start Guide	6
Getting Sound to the Speakers/Connection Example.....	6
Using the Compressor	8
Using the Built-in Effects	9
Controls and Functions	10
Front Panel	10
Rear Panel	12
Troubleshooting	13
Appendix	14
Connecting Speakers.....	14
Vertical/Horizontal Orientation and Installation	15
Rack Mounting	16
Effect Programs	17
Jack and Plug List.....	18
Dimensions	19
General Specifications	20
Index	21

Main Features

Complete Range of Input Channels

This model is equipped with four mono input channels (channels 1 to 4) and four mono/stereo input channels (channels 5/6 to 11/12).

Up to eight microphones can be connected. Line-level devices such as keyboards and CD players can also be connected to each channel. In addition, channel 4 can be used with Hi-Z inputs used to directly connect an instrument such as a guitar or bass guitar.

Compressor

This product is equipped with the popular 1-knob COMP function used in MGP and MG series models. By simply operating a single control, it is possible to get optimal compression for vocals and instruments.

Comprehensive, Professional Effects and Signal Processing

This product is equipped with a powerful, comprehensive DSP section that provides the following effects and processors:

- A total of 24 different effects that are in the same league as our famed SPX effect processor series used by professionals. (See page 9.)
- A feedback suppressor, which automatically prevents undesirable feedback noise. (See section 20 on page 11.)
- A Master EQ, which enables easy adjustment of the master sound to match the usage. (See section 23 on page 11.)

High Efficiency Class-D Amplifier

This model has a built-in high efficiency power amplifier. Despite its low power consumption, it is capable of high volume output while remaining relatively lightweight.

It also has a built-in overload protection function to improve reliability.

Rack Mounting

This product can be mounted onto a 19-inch rack by using the RK-EMX7 (rack-mount brackets) sold separately.

Accessories (Please check that they are included with your mixer.)

- AC power cord (2.5 m)
- Technical Specifications (English only): Includes general specifications, input/output characteristics, and a block diagram.
- Owner's Manual (this document)

Quick Start Guide

Getting Sound to the Speakers/ Connection Example

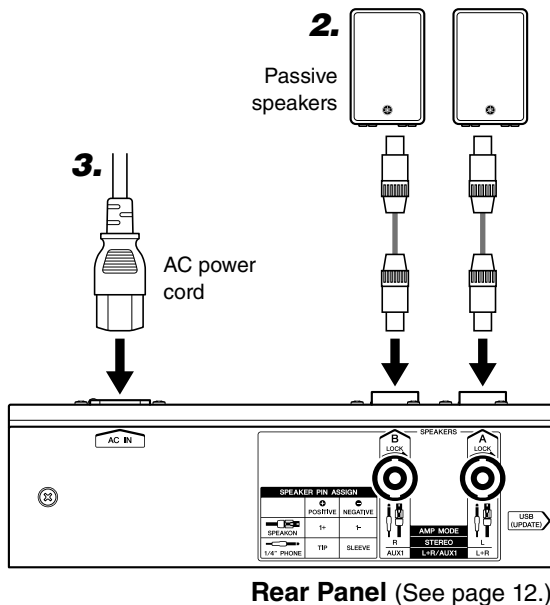

NOTICE

Do not bundle or tie the power cord and speaker cables during use. Due to the large current flowing through the speaker cables, it may lead to acoustic noise or electromagnetic interference.

1. Turn off () all switches (including the (Power) switch).

2. Connect the devices you intend to use.

(The diagram to the right shows a connection example. Also refer to the diagram to the left.)

■ Precautions for Connecting the Speakers

- Connect a single passive speaker (a speaker without an internal amplifier) to the respective [SPEAKERS A/B] jacks. Sending the signal from both [SPEAKERS A/B] jacks to a single speaker may result in malfunction.
- Make sure to insert the speaker cables all the way inside until secure. When connecting a speakON plug, insert it all the way inside, then turn until it locks in place.
- Use speaker cables that have insulated connector handles (housing).
- For details about speaker connection, see page 14.

3. Connect the included power cord.

Connection order:
Mixer [AC IN] jack → Power outlet

NOTE

When removing the power cord, do so in the reverse order.
(Power outlet → Mixer [AC IN] jack)

4. Turn all [LEVEL] controls and MASTER [LEVEL] controls to “0” and set the equalizer controls to the “▼” position.

5. Set the [MIC/ LINE] switch to the “ MIC” position for microphone connection, and to the “ LINE” position for connection of an instrument or audio device.

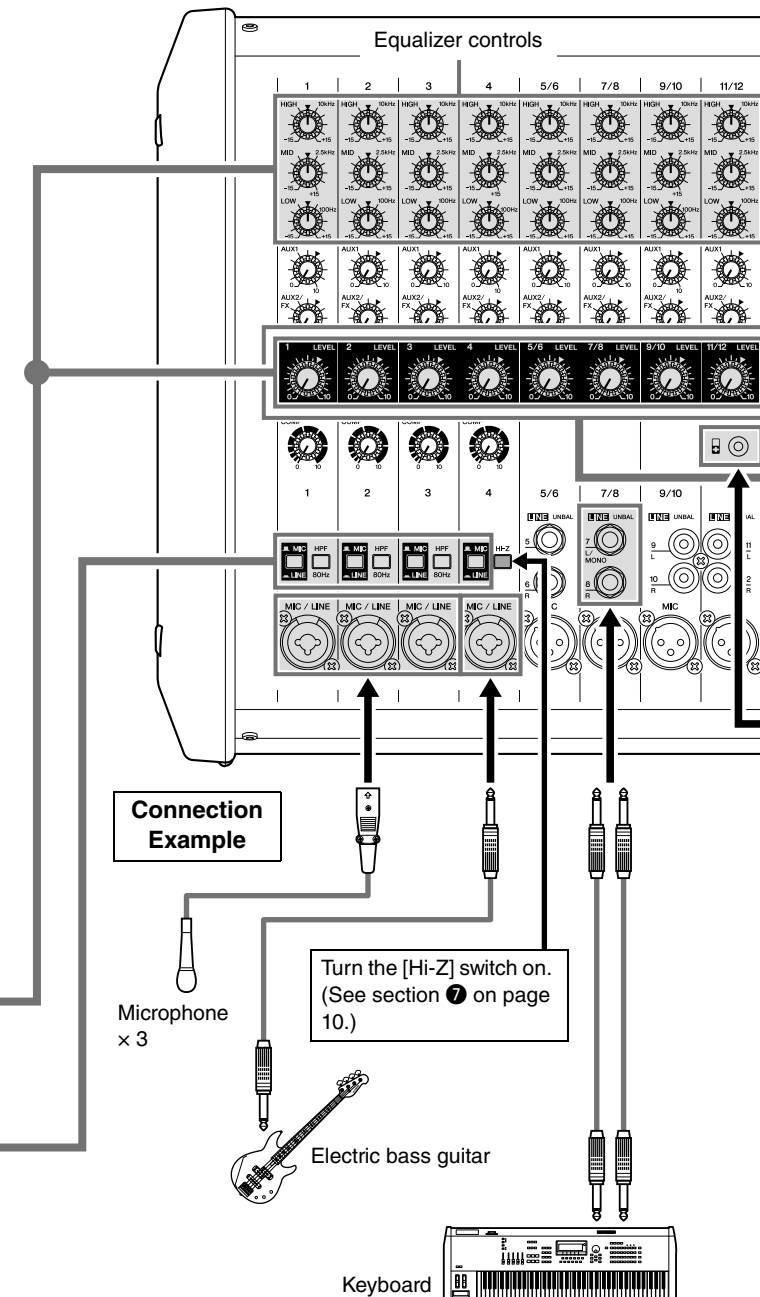

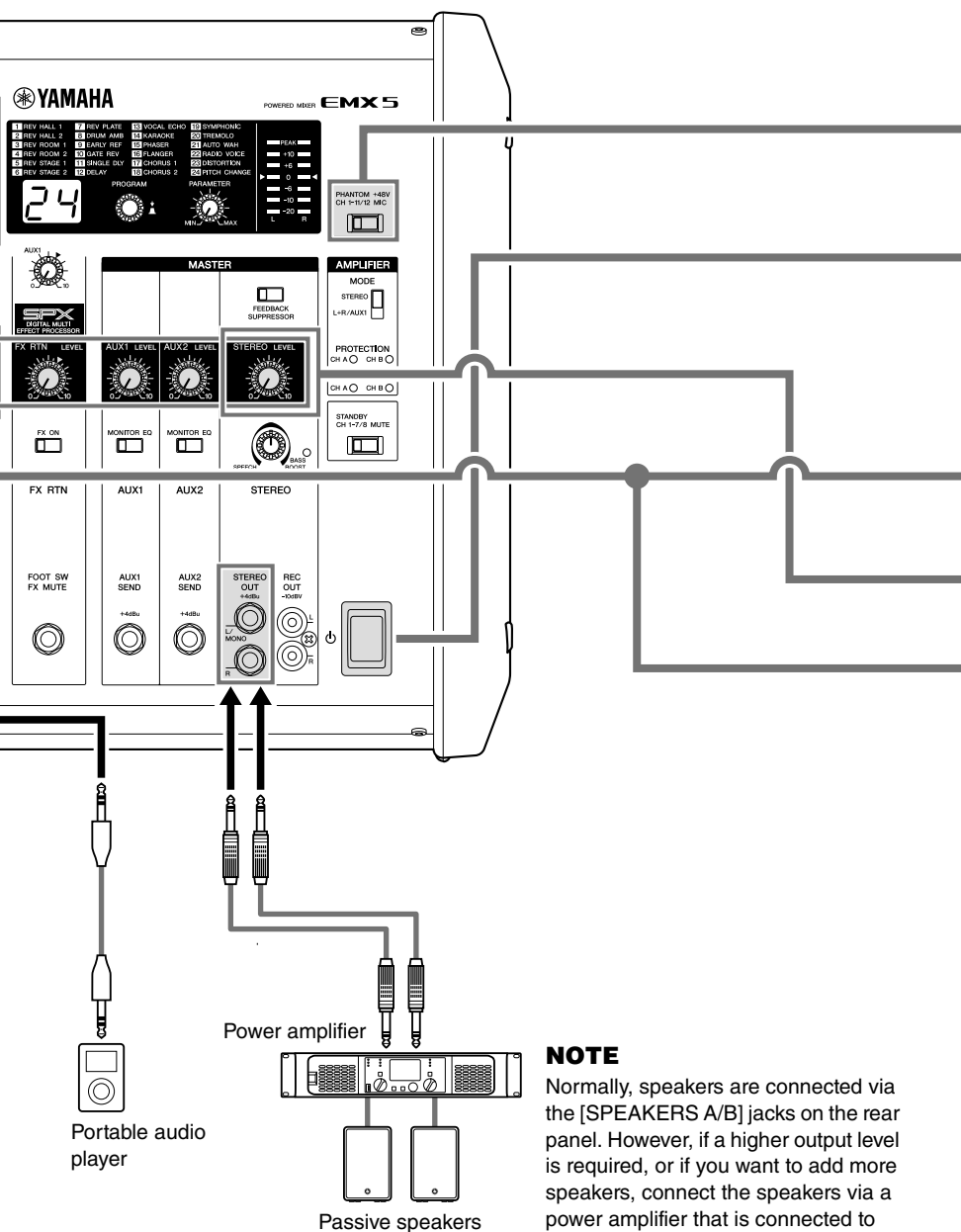
**NOTE**

Normally, speakers are connected via the [SPEAKERS A/B] jacks on the rear panel. However, if a higher output level is required, or if you want to add more speakers, connect the speakers via a power amplifier that is connected to the [STEREO OUT] jack.

6. When connecting a condenser microphone, set the [PHANTOM +48V] switch to the ON position ().

7. Turn on the power.

Switching order:

Instrument or audio device → Mixer [] (Power) switch

⚠ WARNING

When turning off the power, a loud and unpleasant noise may be generated by the speakers. To prevent this, first turn off the Mixer [] (Power) switch, then turn off the instrument or audio device.

8. Set the [LEVEL] control for the channel that has the connected device to the “▼” position.

9. Use the STEREO MASTER [LEVEL] control to adjust the overall sound level.

10. If necessary, adjust the level balance of the connected devices using the [LEVEL] controls for channels 1 to 11/12.

Optimizing the volume settings

● **When the volume is too loud**

Turn the [LEVEL] control to the minimum (zero). Set the [MIC/ LINE] switch to the “ LINE ” position, and then slowly raise the [LEVEL] control until the desired volume is reached.

● **When the volume is too soft**

Turn the [LEVEL] control to the minimum (zero). Set the [MIC/ LINE] switch to the “ MIC ” position, and then slowly raise the [LEVEL] control until the desired volume is reached.

Using the Compressor

When the compressor is applied to vocals, it evens out the input level, reducing the level of loud passages and bringing up softer passages. It also makes each sound more distinct, enabling the listener to better understand the performer's singing.

1. Adjust the [COMP] controls until you get the desired sound for channels you wish to add compression.

Turn the control to the right to increase the level of compression. Avoid setting the value too high, as too much compression may lead to feedback.

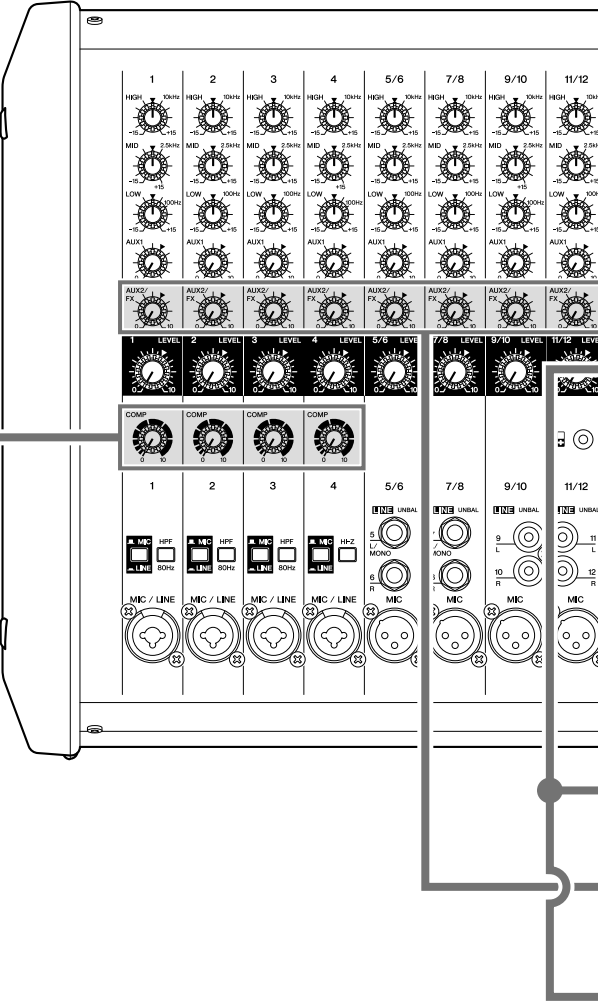

Common Compressor Applications

In addition to vocals, the compressor can be used to enhance the sound of instruments such as guitars, bass guitars, and drums.

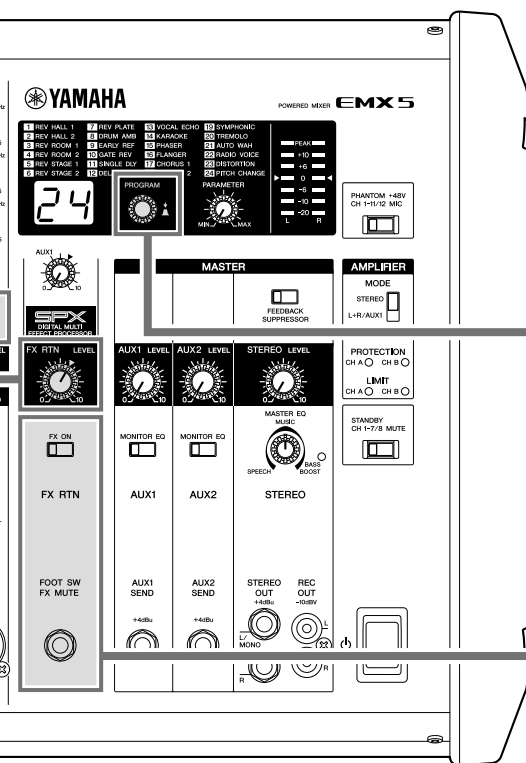

Using the Built-in Effects

It is possible to add particular sound effects or effects that simulate the sound of different performance environments, such as concert halls and small clubs.

1. Use the [PROGRAM] rotary encoder to select the desired effect.

- ① Turn the [PROGRAM] rotary encoder to select the program.
- ② The selected effect program number flashes in the display.
- ③ Press the [PROGRAM] rotary encoder to confirm your selection.



Display

NOTE

- You can also select and confirm the program by simultaneously holding down and turning the [PROGRAM] rotary encoder.
- If no operation is detected for an extended period of time, and the selected program is not confirmed, the system will automatically return to the previously confirmed program.
- For details about available effects, refer to the “Effect Programs” on page 17.

2. Turn on () the FX RTN [FX ON] switch.

The switch lights up to indicate that it is on. Connect a control device such as the optional FC5 foot switch (sold separately) to the [FOOT SW] jack, which lets you conveniently bypass/enable the built-in effects.

3. Set the FX RTN [LEVEL] control to the “▼” position.

4. Use the [AUX2/FX] send controls to adjust the effect depth for each channel you wish to apply the effect.

5. Use the FX RTN [LEVEL] control to adjust the overall effect depth.

NOTE

If you wish to change effect parameters such as reverb time or delay time, adjust the [PARAMETER] control. (See section 18 on page 10.) For details about the parameters of each effect that can be adjusted with the [PARAMETER] control, refer to the “Effect Programs” on page 17.

Controls and Functions

Front Panel

1 Equalizer controls [HIGH]/[MID]/[LOW]

For adjusting the [HIGH], [MID], and [LOW] audio frequencies. Turning the control to the right amplifies (boosts) the corresponding frequency band, while turning to the left attenuates (cuts) the band. Setting the control to the “▼” position produces a flat response in the corresponding band.

2 [AUX1] send controls (Channels 1 – 11/12) [AUX2/FX] send controls (Channels 1 – 11/12)

For adjusting the levels of each signal sent to the AUX1 and AUX2/FX (built-in effects) buses from each channel independently. On channels 5/6 to 11/12, the Line L (odd) and Line R (even) input signals are mixed before being sent into the AUX1 and AUX2/FX buses. Adjust the controls so that they are near the “▼” (nominal) position.

NOTE

The [AUX1] send control is a PRE setting that is not affected by the [LEVEL] control, and the [AUX2/FX] send control is a POST setting that is affected by the [LEVEL] control.

3 [LEVEL] controls (Channels 1 – 11/12)

For adjusting the volume for each channel. Set all [LEVEL] controls on unused channels to the minimum in order to reduce noise.

4 [COMP] controls

For adjusting the amount of compression applied to the corresponding channel. As the [COMP] control is turned to the right, the threshold, ratio, and output gain are adjusted simultaneously.

NOTE

Avoid raising the level of the [COMP] control too high, as the higher average output level that results may lead to feedback.

5 [MIC/LINE] switches (Channels 1 – 4)

For channels with low-level input signal devices such as microphones, set the switches to the “MIC” position. For channels with high-level input signals such as electronic instruments and audio devices, set the switch to the “LINE” position.

6 [HPF] (High Pass Filter) switches (Channels 1 – 3)

Turning this switch on () applies a high-pass filter that attenuates frequencies below 80 Hz in the signal by a slope of 12 dB/octave. This function should be kept on when using vocals in order to reduce noise from vibration or wind picked up by the microphone.

7 [Hi-Z] switch (Channel 4)

Turn this switch on () when you wish to connect instruments with passive pickups such as acoustic-electric guitars or electric bass guitars that do not have internal batteries. It enables such devices to be directly connected to the mixer without the need for a DI (direct injection box). This function affects only the phone jack input.

8 [MIC/LINE] input jacks (Channels 1 – 4)

For connecting microphones, guitars, electronic musical instruments or audio devices. These are compatible with both XLR and phone plugs.



XLR

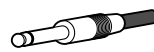

Phone

9 [MIC] input jacks (Channels 5/6, 7/8, 9/10, 11/12)

These are balanced XLR microphone input jacks.

10 [LINE] input jacks (Channels 5/6, 7/8, 9/10, 11/12)

For connecting line-level devices such as electronic instruments, acoustic-electric guitars, CD players, and portable audio players. These are compatible with TS phone, RCA-pin, and stereo mini plugs. Using only the [L/MONO] jacks results in the stereo left and right channels outputting the same signal.

- Channels 5/6, 7/8: TS phone
- Channel 9/10: RCA-pin
- Channel 11/12: RCA-pin, stereo mini



RCA-pin

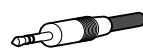

Stereo mini

NOTE

If desired, a single channel's [MIC] and [LINE] jacks can be used together at the same time. But note that the levels cannot be adjusted independently. The stereo mini jack has priority for channel 11/12 [LINE] input jack.

11 FX RTN (Effect Return) [AUX1] send control

For adjusting the level of the signal sent from the built-in effects to the AUX1 bus.

NOTE

The FX RTN [LEVEL] control does not affect the level of the signal sent to the AUX1 bus.

12 FX RTN [LEVEL] control

For adjusting the level of the effect sent from the built-in effects to the STEREO L/R bus.

13 FX RTN [FX ON] switch

For turning the corresponding built-in effects on or off. It lights up when it is switched on ().

NOTE

If this switch is on and the foot switch (see “14 FX RTN [FOOT SW] jack”) is used to mute the built-in effects, the switch flashes.

14 FX RTN [FOOT SW] (Foot Switch) jack

For connecting an unlatched-type foot switch such as the Yamaha FC5. It is useful for solo performers, since it allows you to mute the effects with your foot.

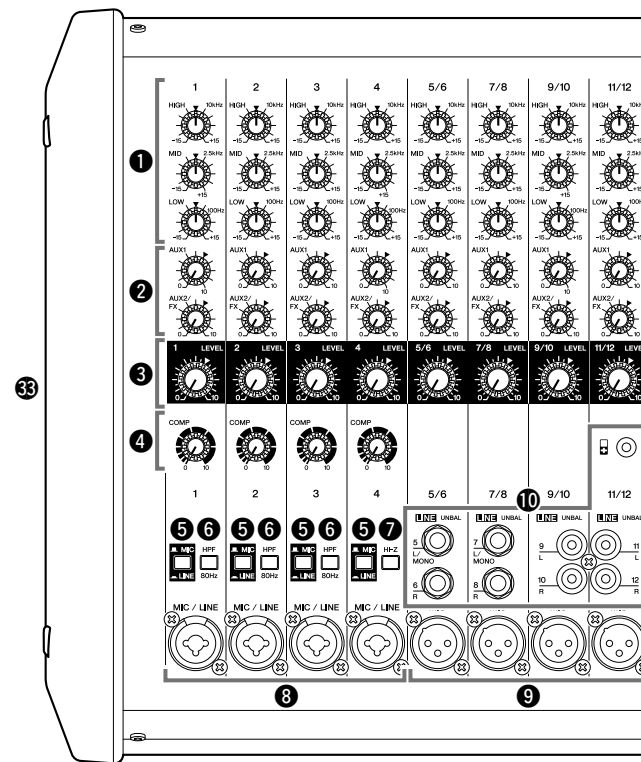

15 Effect program list

This is a convenient on-panel list of the built-in effect programs. For details about these programs, see the “Effect Programs” on page 17.

16 Display

Shows the currently used program and settings screens for each function.

17 [PROGRAM] rotary encoder

For selecting one of the 24 built-in effects. Turn the rotary encoder to select the desired effect, and then press the encoder to enable it.

NOTE

You can also select the desired effect by turning the rotary encoder while holding it down.

18 [PARAMETER] control

For adjusting parameters (depth, speed, etc.) for the selected effect program. The last value used with each effect program is saved.

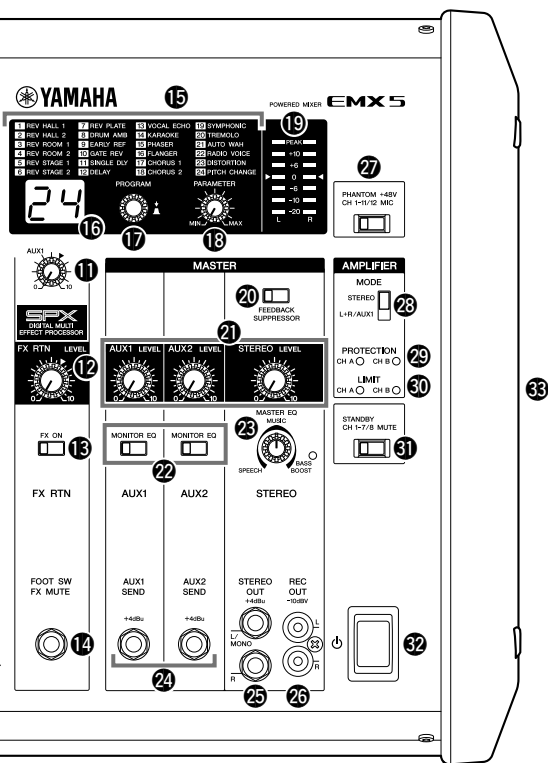

NOTE

When you change to a different effect type, the mixer automatically restores the value that was previously used with the newly selected effect (regardless of the current position of the [PARAMETER] control).

19 Level meter

This uses LED indicators to show the STEREO L/R signal levels. The “0” (◀) segment corresponds to the nominal output level. The “PEAK” segment on the level meter lights up when output reaches the clipping level.

20 [FEEDBACK SUPPRESSOR] switch

When this switch is on (■), it lights up to indicate that feedback is automatically suppressed. (This utilizes a seven-band notch filter. When this switch or the [⏻] (Power) switch is off, the notch filter will be reset.)

21 AUX1 MASTER [LEVEL] control AUX2 MASTER [LEVEL] control STEREO MASTER [LEVEL] control

For adjusting the level of the signals sent to the AUX1, AUX2, and STEREO L/R.

22 [MONITOR EQ] switches

When connecting monitor speakers to the [AUX1 SEND]/[AUX2 SEND] jacks, turning this switch on (■) will cut the unnecessary range to meet the sound quality suited to the monitor indication.

23 [MASTER EQ] control

For adjusting the frequency balance of the overall sound. The center position “MUSIC” is a basic setting and if you turn the control to the left, this creates an optimum setting for speech, cutting unnecessary low range audio frequencies. Turning the control to the right creates an optimum setting for music, by boosting the low and high ranges. Turning it further to the right creates an even more powerful bass tone with the “BASS BOOST” indicator turning on to indicate that the bass boost function is on.

24 [AUX1 SEND] jack [AUX2 SEND] jack

For connecting to a musician monitoring system, external effect device, and so on. These are impedance balanced TRS phone type output jacks. (See the “Jack and Plug List” on page 18.)

25 [STEREO OUT] jacks

These are TRS phone type impedance balanced output jacks that output the mixed stereo signal. The signal level is adjusted by the STEREO MASTER [LEVEL] control before it is output. Using only the [L/MONO] jack lets you obtain a signal composed of the left and right channels mixed together.

26 [REC OUT] jacks

These are unbalanced RCA-pin output jacks. They can be used to connect an external recorder. The output signal from these jacks is not affected by the STEREO MASTER [LEVEL] control. The recording level can be separately adjusted on the recording device.

27 [PHANTOM +48V] switch

Turn this switch on (■) to supply all the XLR input jacks (channels 1 to 11/12) with DC +48 V phantom power. Turning on the switch supplies power to condenser microphones or a DI (direct injection box). When it is on, the switch lights up.

NOTICE

Follow the important precautions below, in order to prevent noise and possible damage to external devices and the mixer when you operate this switch.

- If you do not need phantom power, or when you connect a device that does not support phantom power, be sure to leave this switch off or connect via the phone (channels 1 to 7/8) / RCA-pin (9/10 and 11/12) / stereo mini (11/12) plugs.
- Do not connect or disconnect cables while this switch is on.
- Turn 21 AUX1, AUX2, and STEREO MASTER [LEVEL] controls to the minimum setting before operating this switch.

28 AMPLIFIER [MODE] switch

Determines which signal is output from the [SPEAKERS A/B] jacks: STEREO bus or L+R/AUX1 bus.

29 AMPLIFIER [PROTECTION] indicators

Lights up to indicate amplifier protection is operating. The “CH A” indicator is for the signal sent to the [SPEAKERS A] jack. The “CH B” indicator is for the signal sent to the [SPEAKERS B] jack.

30 AMPLIFIER [LIMIT] indicators

These light up when the DSP amplifier protection limiter is operating. The “CH A” indicator is for the signal sent to the [SPEAKERS A] jack. The “CH B” indicator is for the signal sent to the [SPEAKERS B] jack.

NOTICE

If used at a very high volume such that the indicators flash continuously, the internal power amplifier section will be excessively overloaded and may malfunction. Reduce the output level with the AUX1 and STEREO MASTER [LEVEL] controls so that the indicators flash only briefly on the highest transient peaks.

31 [STANDBY] switch

When this switch is turned on (■), it lights up and all inputs for channels 1 to 7/8 are muted. Please note that channels 9/10 and 11/12 are not muted. This is an added convenience for playing background music during gaps in the performance.

32 [⏻] (Power) switch

For turning the power ON (■) or OFF (■).

⚠ WARNING

Please note that trace current can continue to flow even when the [⏻] (Power) switch is in the OFF position. If you do not plan to use the mixer for an extended period of time, be sure to unplug the power cord from the wall outlet.

NOTICE

Rapidly turning the [⏻] (Power) switch on and off in succession may cause it to malfunction. After turning the mixer OFF, wait for about 10 seconds before turning it ON again.

33 Vents

There are vents located on both sides of the mixer, and a cooling fan is installed on the exhaust side. Do not block the vents on either side when using the mixer.

Rear Panel

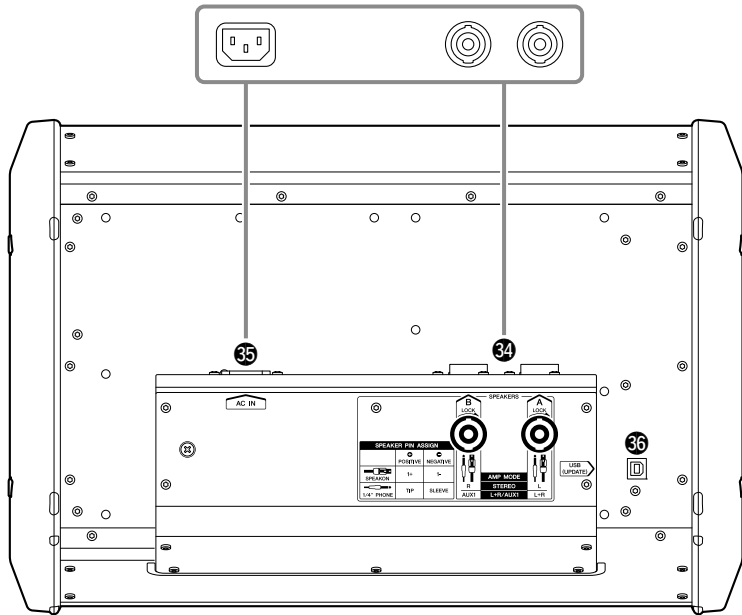

34 [SPEAKERS A/B] jacks

Use commercially available speaker cables to connect the speakers. These jacks can be used with both TS phone and speakON plugs. When connecting a speakON plug, insert it and turn until it locks in place. Also, the signal to be output is determined according to the setting of the AMPLIFIER [MODE] switch 23.

AMPLIFIER [MODE] switch setting	[SPEAKERS A] Jack	[SPEAKERS B] Jack
“STEREO”	STEREO L signal	STEREO R signal
“L+R/AUX1”	L+R signal	AUX1 signal

35 [AC IN] jack

For connecting the included power cord here. First, connect the included power cord to the mixer, and then plug it into an outlet.

NOTICE

Do not bundle or tie the power cord and speaker cables during use. Due to the large current flowing through the speaker cables, it may lead to acoustic noise or electromagnetic interference.

36 [USB] terminal

This is used only for performing maintenance. It is not used during normal operation.

Troubleshooting

Check the following items before contacting your Yamaha dealer.

If the problem remains, contact your nearest Yamaha dealer.

<p>■ The power does not come on.</p>	<p><input type="checkbox"/> Turn off the [⏻] (Power) switch and recheck the connection. Be sure that you are using the included power cord, and that it is correctly connected to the [AC IN] jack and plugged into a working power outlet. If the power still does not come on when pressing the [⏻] (Power) switch after waiting a few minutes, the mixer may be malfunctioning. If this is the case, contact your nearest Yamaha dealer.</p>
<p>■ The power suddenly turns off.</p>	<p><input type="checkbox"/> Check that the vents on the sides of the mixer are not blocked. <input type="checkbox"/> If the internal temperature of the mixer is excessively high, the overload protection function may have been triggered, causing the power to turn off. Turn off the [⏻] (Power) switch and restart the mixer after leaving it for a few minutes.</p>
<p>■ The AMPLIFIER [PROTECTION] indicators are flashing or constantly on.</p>	<p><input type="checkbox"/> When flashing, this indicates that the speaker cables connected to the [SPEAKERS] jack for the corresponding channel may be short circuited. Turn off the [⏻] (Power) switch and inspect the speaker cable for the corresponding channel. <input type="checkbox"/> When constantly on, this indicates that the output has been muted due to amplifier overheating. Please wait until the amplifier has cooled down to an acceptable level. If it does not reset, turn off the [⏻] (Power) switch and restart the mixer after leaving it for a few minutes.</p>
<p>■ No sound is heard.</p>	<p><input type="checkbox"/> Are external devices (including microphones) and speakers connected correctly? <input type="checkbox"/> Are all the input channel [LEVEL] controls and the AUX1, AUX2, and STEREO MASTER [LEVEL] controls set to appropriate levels? <input type="checkbox"/> For channel 11/12, are both RCA and stereo mini jacks connected at the same time? If both are connected, the stereo mini jack will take priority. <input type="checkbox"/> Check that the speaker cables are not shorted.</p>
<p>■ The sound is low, distorted, or noisy.</p>	<p><input type="checkbox"/> Are all the input channel [LEVEL] controls and the AUX1, AUX2, and STEREO MASTER [LEVEL] controls set to appropriate levels? <input type="checkbox"/> Check that the [MIC/LINE] switches on channels 1 to 4 are set correctly. <input type="checkbox"/> Is the input signal from the device connected to the mixer set to an appropriate level? <input type="checkbox"/> If an instrument with passive pickups is connected to channel 4, turn on the [Hi-Z] switch.</p>
<p>■ The selected effect is not applied.</p>	<p><input type="checkbox"/> Check that the [AUX2/FX] send controls on each channel are correctly adjusted. <input type="checkbox"/> Is the FX RTN [FX ON] switch turned on? <input type="checkbox"/> Check that the FX RTN [LEVEL] control is correctly adjusted.</p>
<p>■ The sound from the speakers seems dull, lacking in dynamics and power.</p>	<p><input type="checkbox"/> Are the equalizer controls [HIGH]/[MID]/[LOW] adjusted appropriately? <input type="checkbox"/> Turning the [MASTER EQ] control to the right of the center position "MUSIC", which is the basic setting, will boost low and high range audio frequencies.</p>
<p>■ Speaking voices are not clear.</p>	<p><input type="checkbox"/> Are the equalizer controls [HIGH]/[MID]/[LOW] adjusted appropriately? <input type="checkbox"/> Is the [HPF] switch turned on? <input type="checkbox"/> Turning the [MASTER EQ] control to the left of the center position "MUSIC", which is the basic setting, will suppress low and high range audio frequencies.</p>
<p>■ How can the monitor output be heard?</p>	<p><input type="checkbox"/> Connect a powered speaker (a speaker with an internal amplifier) to the [AUX1 SEND], [AUX2 SEND] jacks. For the [AUX1 SEND] jack and [AUX2 SEND] jack output signals, adjust each channel's [AUX1] send control, [AUX2/FX] send control, as well as the AUX1 and AUX2 MASTER [LEVEL] controls. <input type="checkbox"/> Set the AMPLIFIER [MODE] switch to "L+R/AUX1" to enable the monitor signal (AUX1) to be output from the rear panel [SPEAKERS B] jack. The STEREO L/R mixed signal is output from the [SPEAKERS A] jack.</p>

Appendix

Connecting Speakers

When you wish to connect multiple speakers from the [SPEAKERS A/B] jacks in parallel, keep in mind that the overall impedance does not fall below 4 ohms. When connecting speakers with the same impedance in parallel, the overall impedance value is half with two speakers, one-third with three speakers, and only one-quarter with four speakers.

⚠ CAUTION

- When connecting each device, only use appropriately rated cables and plugs. Only use proper speaker cable when connecting speakers.
- Make sure to insert the speaker cables all the way inside until secure. When connecting a speakON plug, insert it all the way inside, then turn until it locks in place.
- Use speaker cables with an insulated-housing connector.

■ 2-channel Connection

When connecting using the following configuration, use speakers with impedance from 4 ohms to 8 ohms.

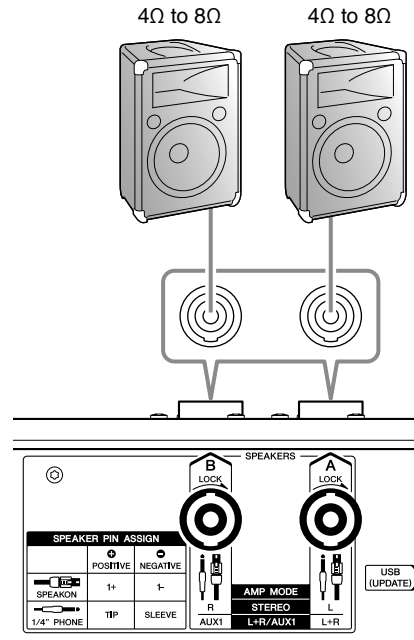

■ 2-channel Parallel Connection

When connecting speakers in parallel configuration, use speakers with impedance from 8 ohms to 16 ohms.

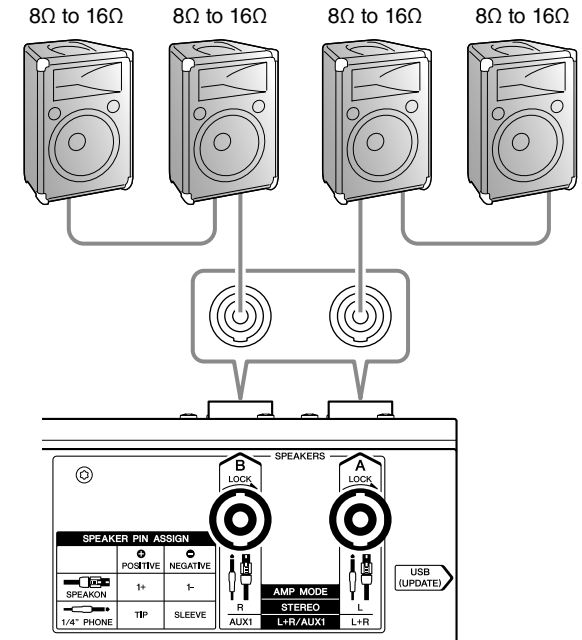

Vertical/Horizontal Orientation and Installation

The mixer orientation can be changed for ease in operation and for adapting to different installation needs.

■ Vertical Orientation

This is convenient when operating the mixer on a tabletop.

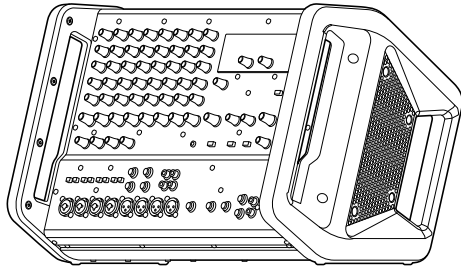

■ Horizontal Orientation

This is convenient when operating from a seated position with the mixer placed on the floor.

⚠ CAUTION

Do not push too forcefully when tilting the mixer. Excess force may cause the mixer to topple or turn, potentially resulting in equipment damage or in injury to bystanders.

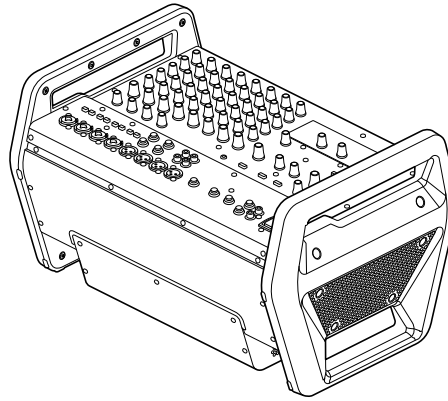

■ Installation

This mixer has vents located on the sides. Please install it so that these vents are well clear of walls or other objects.

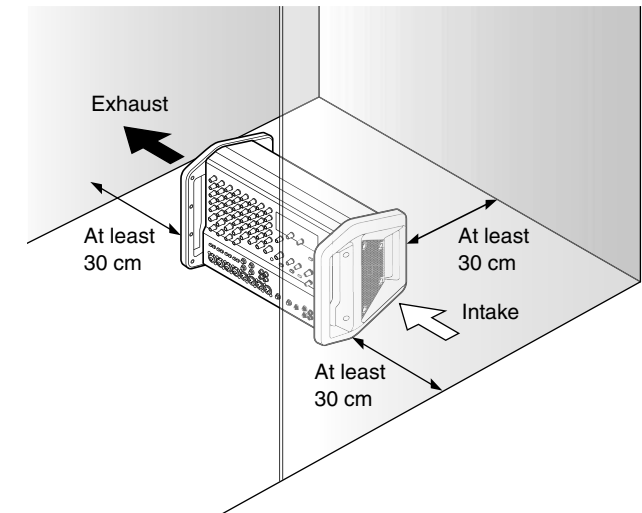

Rack Mounting

To prepare the mixer for rack mounting, use the RK-EMX7 (rack-mount brackets) sold separately. This mixer requires 7U* of rack-mount space.

* 7U is approximately 312 mm.

⚠ CAUTION

This mixer is heavy, and should be lifted by two people when mounting onto a rack.

■ Precautions for Rack Mounting

This mixer is rated for operation at ambient temperatures ranging from 0 to 40 degrees Celsius. If you install this mixer along with other devices in a poorly ventilated EIA standard rack, the ambient temperature inside the rack may rise, resulting in inefficient performance. Be sure to rack-mount according to the following conditions so the mixer does not overheat.

- When mounting the mixer in a rack with devices such as power amplifiers that generate a significant amount of heat, leave more than 1U of space between it and other devices. Also, either leave the open spaces uncovered or install appropriate ventilating panels to minimize the possibility of heat buildup.
- To ensure sufficient airflow, leave the rear of the rack open. If you have installed a fan kit in the rack, there may be cases in which closing the rear of the rack will produce a greater cooling effect. Refer to the rack and/or fan kit manual for more details.

■ Assembly of the Rack-mount Brackets

1. Use a screwdriver to loosen and remove the 12 screws on the mixer side pads.

NOTICE

During installing the rack-mount brackets, take care to ensure that the screws do not damage surfaces such as table tops. Place a soft cloth under the mixer for protection.

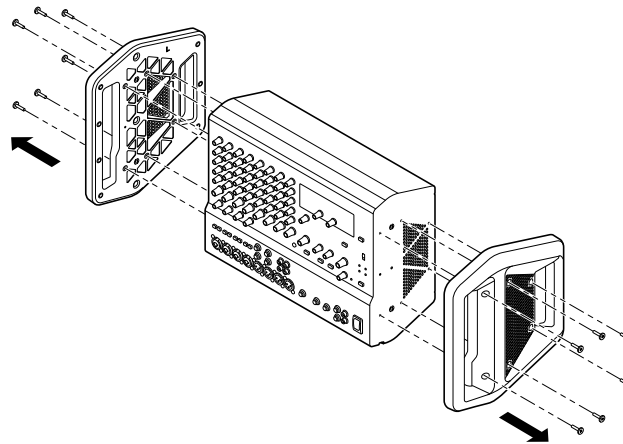

2. Use six of the screws you removed in Step 1 to securely install the RK-EMX7 separately sold (rack-mount brackets) onto the mixer.

NOTICE

Be sure to use the same screws removed from the mixer in Step 1. Using other screws may cause damage.

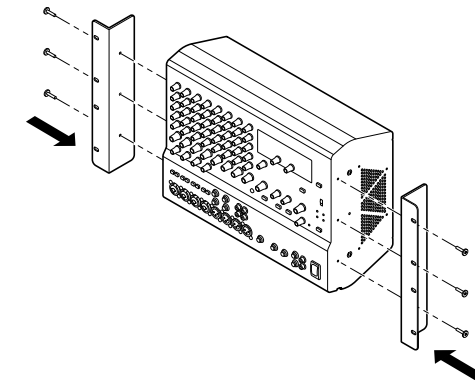

3. Carefully store the remaining six screws that are not used in Step 2 so they are not lost. Once the rack-mount brackets are installed there will be a total of eight empty screw holes on the both sides of the mixer.

NOTE

Separate screws for actually mounting the mixer in a rack are not included with the mixer.

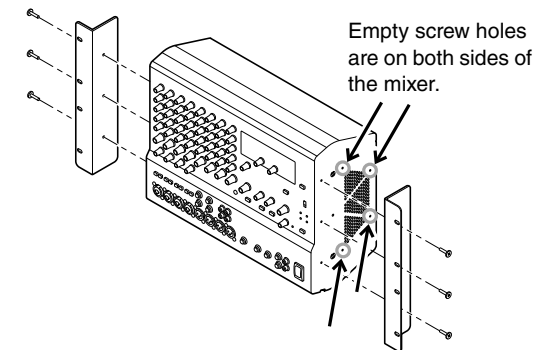

4. If you wish to remove the rack-mount brackets and reinstall the side pads, ensure that they are installed on the correct sides of the mixer. The inside surface of the side pads are marked as "L" (Left) or "R" (Right).

Effect Programs

No.	Program	Parameter	Description
1	REV HALL 1	Reverb Time	Reverb simulating a large space such as a concert hall.
2	REV HALL 2	Reverb Time	
3	REV ROOM 1	Reverb Time	Reverb simulating the acoustics of a small space (room).
4	REV ROOM 2	Reverb Time	
5	REV STAGE 1	Reverb Time	Reverb simulating a large stage.
6	REV STAGE 2	Reverb Time	
7	REV PLATE	Reverb Time	Simulation of a metal-plate reverb unit, producing a more hard-edged reverberation.
8	DRUM AMB	Reverb Time	A short reverb that is ideal for use with a drum kit.
9	EARLY REF	Room Size	An effect which isolates only the early reflection components from reverberation, creating a 'flashier' effect than conventional reverb.
10	GATE REV	Room Size	An effect which cuts halfway the tail-end of the reverberation, making a more powerful sound.
11	SINGLE DLY	Delay Time	An effect which repeats the same sound only once. Shortening the delay time produces a doubling effect.
12	DELAY	Delay Time	Feedback delay adding multiple delayed signals.
13	VOCAL ECHO	Delay Time	Echo designed for conventional vocals.
14	KARAOKE	Delay Time	Echo designed for karaoke (sing-along) applications.
15	PHASER	LFO* Freq	Cyclically changes the phase to add modulation to the sound.
16	FLANGER	LFO* Freq	Adds modulation to the sound, producing an effect similar to the rise and fall sound of a jet engine.
17	CHORUS 1	LFO* Freq	Creates a thicker ensemble-like sound by adding the multiple sounds with different delay times.
18	CHORUS 2	LFO* Freq	
19	SYMPHONIC	LFO* Depth	Multiplies the sound for thicker texture.
20	TREMOLO	LFO* Freq	An effect which cyclically modulates the volume.
21	AUTO WAH	LFO* Freq	A wah-wah effect with cyclical filter modulation. The [PARAMETER] control adjusts the speed of the LFO* that modulates the "wah" filter.
22	RADIO VOICE	Cutoff Offset	Recreates the lo-fi sound of an AM radio. The [PARAMETER] control adjusts the frequency band to be emphasized.
23	DISTORTION	Drive	Adds a sharp-edged distortion to the sound.
24	PITCH CHANGE	Pitch	An effect which changes the pitch of the signal.

* "LFO" stands for Low Frequency Oscillator. An LFO is normally used to periodically modulate another signal, using different waveform shapes and modulation speeds.

Jack and Plug List

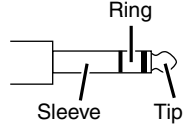
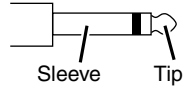
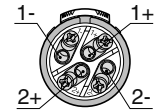
Jack (Input/Output)	Polarity	Balanced/Unbalanced	Configuration
MIC/LINE MIC	Pin 1: Ground Pin 2: Hot (+) Pin 3: Cold (-)	Balanced	XLR jack Input 
MIC/LINE* ¹	Tip: Hot (+) Ring: Cold (-) Sleeve: Ground	Balanced	TRS phone plug 
AUX1 SEND* ¹ AUX2 SEND* ¹ STEREO OUT* ¹	Tip: Hot (+) Ring: Cold (-) Sleeve: Ground	Impedance balanced* ²	
LINE 5/6, 7/8 FOOT SW	Tip: Signal Sleeve: Ground	Unbalanced	TS phone plug 
SPEAKERS A/B	Tip: Positive Sleeve: Negative		
SPEAKERS A/B	1+: Positive 1-: Negative	—	speakON plug 

*1 These jacks also can be connected with TS phone plugs. If you use TS phone plugs, the connection will be unbalanced.

*2 Since the hot and cold terminals of impedance balanced output jacks have the same impedance, the balanced connection enables these output jacks to be less affected by induced noise.

Dimensions

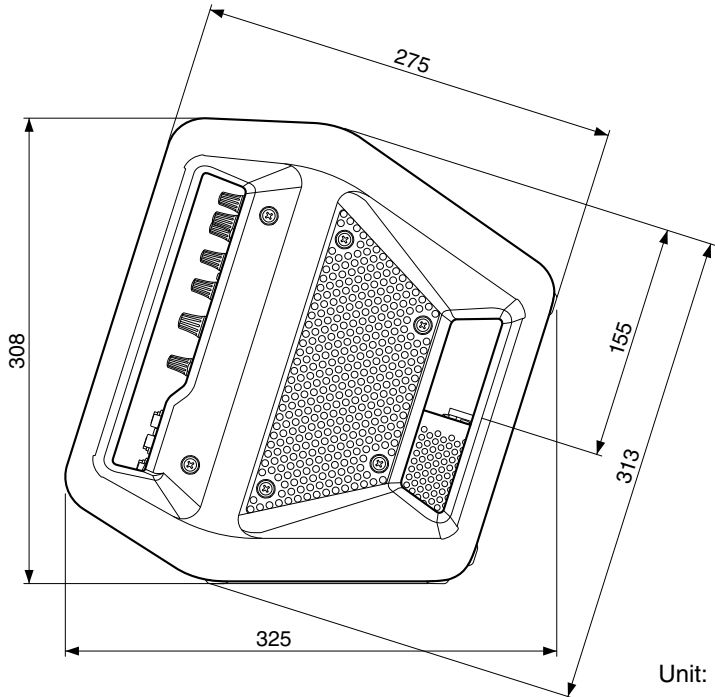
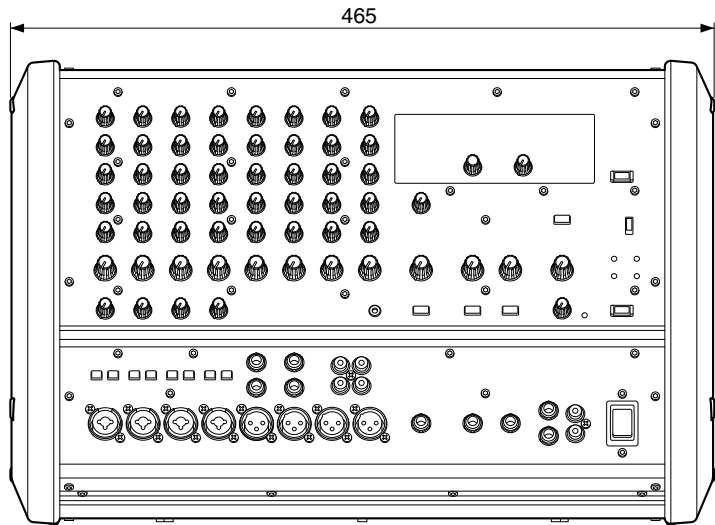
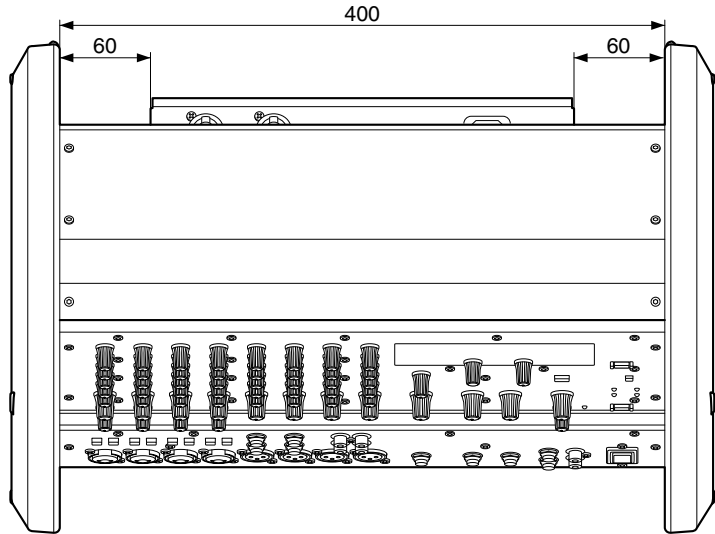

Unit: mm

General Specifications

Maximum Output Power (1 kHz)		THD+N <10% 630 W + 630 W (4 Ω), 460 W + 460 W (8 Ω) THD+N <1% 500 W + 500 W (4 Ω), 370 W + 370 W (8 Ω)
Input Channels		12 channels (max. 8 MIC/12 LINE, 4 Mono + 4 Stereo) CH4: Hi-Z input supported
Output Channels		SPEAKERS (A, B): 1, AUX1 SEND: 1, AUX2 SEND: 1, STEREO OUT (L, R): 1, REC OUT (L, R): 1
Bus		Stereo: 1 AUX: 2 (Including FX)
Input Channel Function	COMP	Multiple parameters (gain, threshold, ratio) can be adjusted simultaneously with a single control. Threshold: +22 dBu to -8 dBu, Ratio: 1:1 to 4:1, Output level: 0 dB to +7 dB Attack time: approx. 25 ms, Release time: approx. 300 ms
	Equalizer	HIGH: 10 kHz ±15 dB (Shelving) MID: 2.5 kHz ±15 dB (Peaking) LOW: 100 Hz ±15 dB (Shelving)
Level Meter		2 × 7 points LED meter (-20, -10, -6, 0, +6, +10, PEAK)
Phantom Power Voltage		+48 V
Built-in Effect	SPX Algorithm	24 programs
FOOT SW		Effect mute on/off
DSP Processing		Feedback suppressor, Master EQ
Protection		Load Protection: DC-fault Amplifier Protection: Over heat protection, Over current protection, Integral power protection Power Supply Protection: Over heat protection, Over current protection
Power Requirements		AC 100–240 V, 50 Hz/60 Hz
Power Consumption		42 W (Idle) / 210 W (1/8 Power)
Dimensions when placed vertically (W × H × D)		465 mm × 308 mm × 325 mm (18.3" × 12.1" × 12.8")
Net Weight		9.5 kg (20.9 lb)
Optional Accessory		Rack-mount brackets: RK-EMX7, Foot switch: FC5
Operating Temperature		0 to +40°C

For other specifications, see the included "Technical Specifications."

The contents of this manual apply to the latest specifications as of the publishing date. To obtain the latest manual, access the Yamaha website then download the manual file.

Index

A

[AC IN] jack	12
AMPLIFIER [LIMIT] indicators.....	11
AMPLIFIER [MODE] switch	11, 12
AMPLIFIER [PROTECTION] indicators	11
AUX1 MASTER [LEVEL] control.....	11
[AUX1] send controls	10
[AUX1 SEND] jack	11
[AUX2/FX] send controls.....	10
AUX2 MASTER [LEVEL] control.....	11
[AUX2 SEND] jack	11

C

[COMP] controls.....	8, 10
----------------------	-------

D

DI (direct injection box)	10, 11
Display	10

E

Effect program list	10
Equalizer controls [HIGH]/[MID]/[LOW].....	10

F

Feedback	11
[FEEDBACK SUPPRESSOR] switch.....	11
FX RTN (Effect Return) [AUX1] send control.....	10
FX RTN (Effect Return) [FOOT SW] (Foot Switch) jack	10
FX RTN (Effect Return) [FX ON] switch.....	10
FX RTN (Effect Return) [LEVEL] control.....	10



H

[Hi-Z] switch	6, 10
[HPF] (High Pass Filter) switches	10

L

[LEVEL] controls	10
Level meter	11
[LINE] input jacks	10

M

[MASTER EQ] control	11
[MIC] input jacks	10
[MIC/LINE] input jacks	10
[ MIC/  LINE] switches.....	7, 10
Mixer accessory	
Rack-mount brackets	5, 16
[MONITOR EQ] switches	11

P

Parallel connection.....	14
[PARAMETER] control.....	10
[PHANTOM +48V] switch	11
Phone.....	18
[] (Power) switch	11
[PROGRAM] rotary encoder	10

R

Rack-mount brackets	5, 16
[REC OUT] jacks.....	11

S

[SPEAKERS A/B] jacks.....	12
[SPEAKERS A] Jack.....	12
[SPEAKERS B] Jack.....	12
speakON	12, 18
[STANDBY] switch	11
STEREO MASTER [LEVEL] control	11
[STEREO OUT] jack	7, 11

U

[USB] terminal.....	12
---------------------	----

V

Vents.....	11, 15
------------	--------

X

XLR.....	18
----------	----

FCC INFORMATION (U.S.A.)

1. IMPORTANT NOTICE: DO NOT MODIFY THIS UNIT!

This product, when installed as indicated in the instructions contained in this manual, meets FCC requirements. Modifications not expressly approved by Yamaha may void your authority, granted by the FCC, to use the product.

2. IMPORTANT: When connecting this product to accessories and/or another product use only high quality shielded cables. Cable/s supplied with this product **MUST** be used. Follow all installation instructions. Failure to follow instructions could void your FCC authorization to use this product in the USA.

3. NOTE: This product has been tested and found to comply with the requirements listed in FCC Regulations, Part 15 for Class "B" digital devices. Compliance with these requirements provides a reasonable level of assurance that your use of this product in a residential environment will not result in harmful interference with other electronic devices. This equipment generates/uses radio frequencies and, if not installed and used according to the instructions found in the users manual, may cause interference harmful to the operation of other

electronic devices. Compliance with FCC regulations does not guarantee that interference will not occur in all installations. If this product is found to be the source of interference, which can be determined by turning the unit "OFF" and "ON," please try to eliminate the problem by using one of the following measures:

Relocate either this product or the device that is being affected by the interference.

Utilize power outlets that are on different branch (circuit breaker or fuse) circuits or install AC line filter/s.

In the case of radio or TV interference, relocate/reorient the antenna. If the antenna lead-in is 300 ohm ribbon lead, change the lead-in to co-axial type cable.

If these corrective measures do not produce satisfactory results, please contact the local retailer authorized to distribute this type of product. If you can not locate the appropriate retailer, please contact Yamaha Corporation of America, Electronic Service Division, 6600 Orangethorpe Ave, Buena Park, CA90620

The above statements apply **ONLY** to those products distributed by Yamaha Corporation of America or its subsidiaries.

The model number, serial number, power requirements, etc., may be found on or near the name plate, which is at the rear of the unit. You should note this serial number in the space provided below and retain this manual as a permanent record of your purchase to aid identification in the event of theft.

Model No.

Serial No.

(rear_en_01)

In Finland: Laite on liitettävä suojamaadoituskoskettimilla varustettuun pistorasiaan.

In Norway: Apparatet må tilkoples jordet stikkontakt.

In Sweden: Apparatens skall anslutas till jordat uttag.

(class I hokuo)

* This applies only to products distributed by YAMAHA CORPORATION OF AMERICA.

(class B)

Information for Users on Collection and Disposal of Old Equipment



This symbol on the products, packaging, and/or accompanying documents means that used electrical and electronic products should not be mixed with general household waste.

For proper treatment, recovery and recycling of old products, please take them to applicable collection points, in accordance with your national legislation and the Directives 2002/96/EC.

By disposing of these products correctly, you will help to save valuable resources and prevent any potential negative effects on human health and the environment which could otherwise arise from inappropriate waste handling.

For more information about collection and recycling of old products, please contact your local municipality, your waste disposal service or the point of sale where you purchased the items.

[For business users in the European Union]

If you wish to discard electrical and electronic equipment, please contact your dealer or supplier for further information.

[Information on Disposal in other Countries outside the European Union]

This symbol is only valid in the European Union. If you wish to discard these items, please contact your local authorities or dealer and ask for the correct method of disposal.

(weee_eu_en_01)

Important Notice: Guarantee Information for customers in European Economic Area (EEA) and Switzerland

Important Notice: Guarantee Information for customers in EEA* and Switzerland	English
Für nähere Garantie-Information über dieses Produkt von Yamaha, sowie über den Pan-EWR*- und Schweizer Garantieservice, besuchen Sie bitte entweder die folgend angegebene Internetadresse (eine druckfähige Version befindet sich auch auf unserer Webseite), oder wenden Sie sich an den für Ihr Land zuständigen Yamaha-Vertrieb. *EWR: Europäischer Wirtschaftsraum	
Wichtiger Hinweis: Garantie-Information für Kunden in der EWR* und der Schweiz	Deutsch
Für nähere Garantie-Information über dieses Produkt von Yamaha, sowie über den Pan-EWR*- und Schweizer Garantieservice, besuchen Sie bitte entweder die folgend angegebene Internetadresse (eine druckfähige Version befindet sich auch auf unserer Webseite), oder wenden Sie sich an den für Ihr Land zuständigen Yamaha-Vertrieb. *EWR: Europäischer Wirtschaftsraum	
Remarque importante: informations de garantie pour les clients de l'EEE et la Suisse	Français
Pour des informations plus détaillées sur la garantie de ce produit Yamaha et sur le service de garantie applicable dans l'ensemble de l'EEE ainsi qu'en Suisse, consultez notre site Web à l'adresse ci-dessous (le fichier imprimable est disponible sur notre site Web) ou contactez directement Yamaha dans votre pays de résidence. * EEE : Espace Economique Européen	
Belangrijke mededeling: Garantie-informatie voor klanten in de EER* en Zwitserland	Nederlands
Voor gedetailleerde garantie-informatie over dit Yamaha-product en de garantieservice in heel de EER* en Zwitserland, gaat u naar de onderstaande website (u vind een afdrukbaar bestand op onze website) of neemt u contact op met de vertegenwoordiging van Yamaha in uw land. * EER: Europese Economische Ruimte	
Aviso importante: información sobre la garantía para los clientes del EEE* y Suiza	Español
Para una información detallada sobre este producto Yamaha y sobre el soporte de garantía en la zona EEE* y Suiza, visite la dirección web que se incluye más abajo (la versión del archivo para imprimir esta disponible en nuestro sitio web) o póngase en contacto con el representante de Yamaha en su país. * EEE: Espacio Económico Europeo	
Avviso importante: informazioni sulla garanzia per i clienti residenti nell'EEA* e in Svizzera	Italiano
Per informazioni dettagliate sulla garanzia relativa a questo prodotto Yamaha e l'assistenza in garanzia nei paesi EEA* e in Svizzera, potete consultare il sito Web all'indirizzo riportato di seguito (è disponibile il file in formato stampabile) oppure contattare l'ufficio di rappresentanza locale della Yamaha. * EEA: Area Economica Europea	
Aviso importante: informações sobre as garantias para clientes da AEE* e da Suíça	Português
Para obter uma informação pormenorizada sobre este produto da Yamaha e sobre o serviço de garantia na AEE* e na Suíça, visite o site a seguir (o arquivo para impressão está disponível no nosso site) ou entre em contato com o escritório de representação da Yamaha no seu país. * AEE: Área Económica Européia	
Σημαντική σημείωση: Πληροφορίες εγγύησης για τους πελάτες στον EOX* και Ελλάδα	Ελληνικά
Για λεπτομερείς πληροφορίες εγγύησης σχετικά με το παρόν προϊόν της Yamaha και την κάλυψη εγγύησης σε όλες τις χώρες του EOX και την Ελλάδα, επισκεφτείτε την παρακάτω ιστοσελίδα (Εκτυπώσιμη μορφή είναι διαθέσιμη στην ιστοσελίδα μας) ή απευθυνθείτε στην αντιπροσωπεία της Yamaha στη χώρα σας. * EOX: Ευρωπαϊκός Οικονομικός Χώρος	
Viktigt: Garantiinformation för kunder i EES-området* och Schweiz	Svenska
För detaljerad information om denna Yamahaprodukt samt garantiservice i hela EES-området* och Schweiz kan du antingen besöka nedanstående webbadress (en utskriftsvänlig fil finns på webbplatsen) eller kontakta Yamahas officiella representant i ditt land. * EES: Europeiska Ekonomiska Samarbetsområdet	
Viktig merknad: Garantiinformasjon for kunder i EØS* og Sveits	Norsk
Detaljert garantiinformasjon om dette Yamaha-produktet og garantiservice for hele EØS-området* og Sveits kan fås enten ved å besøke nettstedene nedenfor (utskriftsversjon finnes på våre nettsider) eller kontakte kontakten Yamaha-kontoret i landet der du bor. *EØS: Det europeiske økonomiske samarbeidsområdet	
Vigtig oplysning: Garantioplysninger til kunder i EØO* og Schweiz	Dansk
De kan finde detaljerede garantioplysninger om dette Yamaha-produkt og den fælles garantiserviceordning for EØO* (og Schweiz) ved at besøge det websted, der er angivet nedenfor (der findes en fil, som kan udskrives, på vores websted), eller ved at kontakte Yamahas nationale repræsentationskontor i det land, hvor De bor. * EØO: Det Europæiske Økonomiske Område	

Tärkeä ilmoitus: Takuutiedot Euroopan talousalueen (ETA)* ja Sveitsin asiakkaille	Suomi
Tämän Yamaha-tuotteen sekä ETA-alueen ja Sveitsin takuuta koskevat yksityiskohtaiset tiedot saatte alla olevasta nettiosoitteesta. (Tulostettava tiedosto saatavissa sivustollamme.) Voitte myös ottaa yhteyttä paikalliseen Yamaha-edustajaan. *ETA: Euroopan talousalue	
Ważne: Warunki gwarancyjne obowiązujące w EOG* i Szwajcarii	Polski
Aby dowiedzieć się więcej na temat warunków gwarancyjnych tego produktu firmy Yamaha i serwisu gwarancyjnego w całym EOG* i Szwajcarii, należy odwiedzić wskazaną poniżej stronę internetową (Plik gotowy do wydruku znajduje się na naszej stronie internetowej) lub skontaktować się z przedstawicielstwem firmy Yamaha w swoim kraju. * EOG — Europejski Obszar Gospodarczy	
Důležité oznámení: Záruční informace pro zákazníky v EHS* a ve Švýcarsku	Česky
Podrobné záruční informace o tomto produktu Yamaha a záručním servisu v celém EHS* a ve Švýcarsku naleznete na níže uvedené webové adrese (soubor k tisku je dostupný na našich webových stránkách) nebo se můžete obrátit na zastoupení firmy Yamaha ve své zemi. * EHS: Evropský hospodářský prostor	
Fontos figyelmeztetés: Garancia-információk az EGT* területén és Svájcban élő vásárlók számára	Magyar
A jelen Yamaha termékére vonatkozó részletes garancia-információk, valamint az EGT*-re és Svájcra kiterjedő garanciális szolgáltatás tekintetében keresse fel webhelyünket az alábbi címen (a webhelyen nyomtatható fájl is talál), vagy pedig lépjen kapcsolatba az országában működő Yamaha képviselői irodával. * EGT: Európai Gazdasági Térség	
Oluline märkus: Garantiiteave Euroopa Majanduspiirkonna (EMP)* ja Šveitsi klientidele	Eesti keel
Täpsema teabe saamiseks selle Yamaha toote garantii ning kogu Euroopa Majanduspiirkonna ja Šveitsi garantiiteeninduse kohta, külastage palun veebisaiti alljärgneval aadressil (meie saidil on saadaval prinditav fail) või pöörduge Teie regiooni Yamaha esinduse poole. * EMP: Euroopa Majanduspiirkond	
Svarīgs paziņojums: garantijas informācija klientiem EEZ* un Šveicē	Latviešu
Lai saņemtu detalizētu garantijas informāciju par šo Yamaha produktu, kā arī garantijas apkalpošanu EEZ* un Šveicē, lūdzam apmeklējiet zemāk norādīto tīmekļa vietnes adresi (tīmekļa vietnē ir pieejams drukājams fails) vai sazinieties ar jūsu valsti apkalpojošo Yamaha pārstāvniecību. * EEZ: Eiropas Ekonomikas zona	
Démesio: informacija dėl garantijos pirkėjams EEE* ir Šveicarijoje	Lietuvių kalba
Jei reikia išsamios informacijos apie šį „Yamaha“ produktą ir jo techninę priežiūrą visoje EEE* ir Šveicarijoje, apsilankykite mūsų svetainėje toliau nurodytu adresu (svetainėje yra spausdintinas failas) arba kreipkitės į „Yamaha“ atstovybę savo šaliai. *EEE – Europos ekonominė erdvė	
Dôležité upozornenie: Informácie o záruke pre zákazníkov v EHP* a Švajčiarsku	Slovenčina
Podrobné informácie o záruke týkajúce sa tohto produktu od spoločnosti Yamaha a garančnom servise v EHP* a Švajčiarsku nájdete na webovej stránke uvedenej nižšie (na našej webovej stránke je k dispozícii súbor na tlač) alebo sa obráťte na zástupcu spoločnosti Yamaha vo svojej krajine. * EHP: Európsky hospodársky priestor	
Pomembno obvestilo: Informacije o garanciji za kupce v EGP* in Švici	Slovenščina
Za podrobnejše informacije o tem Yamahinem izdelku ter garancijskem servisu v celotnem EGP in Švici, obiščite spletno mesto, ki je navedeno spodaj (natisljiva datoteka je na voljo na našem spletnem mestu), ali se obrnite na Yamahinega predstavnika v svoji državi. * EGP: Evropski gospodarski prostor	
Важно съобщение: Информация за гаранцията за клиенти в ЕИП* и Швейцария	Български език
За подробна информация за гаранцията за този продукт на Yamaha и гаранционното обслужване в паневропейската зона на ЕИП* и Швейцария или посетете посочения по-долу уеб сайт (на нашия уеб сайт има файл за печат), или се свържете с представителния офис на Yamaha във вашата страна. * ЕИП: Европейско икономическо пространство	
Notificare importantă: Informații despre garanție pentru clienții din SEE* și Elveția	Limba română
Pentru informații detaliate privind acest produs Yamaha și serviciul de garanție Pan-SEE* și Elveția, vizitați site-ul la adresa de mai jos (fișierul imprimabil este disponibil pe site-ul nostru) sau contactați biroul reprezentanței Yamaha din țara dumneavoastră. * SEE: Spațiul Economic European	

<http://europe.yamaha.com/warranty/>

ADDRESS LIST

NORTH AMERICA

CANADA

Yamaha Canada Music Ltd.
135 Milner Avenue, Toronto, Ontario, M1S 3R1, Canada
Tel: +1-416-298-1311

U.S.A.

Yamaha Corporation of America
6600 Orangethorpe Avenue, Buena Park, CA 90620, U.S.A.
Tel: +1-714-522-9011

CENTRAL & SOUTH AMERICA

MEXICO

Yamaha de México, S.A. de C.V.
Av. Insurgentes Sur 1647 Piso 9, Col. San José Insurgentes,
Delegación Benito Juárez, México, D.F., C.P. 03900, México
Tel: +52-55-5804-0600

BRAZIL

Yamaha Musical do Brasil Ltda.
Rua Fidêncio Ramos, 302 – Cj 52 e 54 – Torre B – Vila
Olímpia – CEP 04551-010 – São Paulo/SP, Brazil
Tel: +55-11-3704-1377

ARGENTINA

Yamaha Music Latin America, S.A., Sucursal Argentina
Olga Cossetini 1553, Piso 4 Norte,
Madero Este-C1107CEK,
Buenos Aires, Argentina
Tel: +54-11-4119-7000

PANAMA AND OTHER LATIN AMERICAN COUNTRIES/ CARIBBEAN COUNTRIES

Yamaha Music Latin America, S.A.
Edif. Torre Banco General, Piso 7, Urbanización Marbella,
Calle 47 y Aquilino de la Guardia,
Ciudad de Panamá, República de Panamá
Tel: +507-269-5311

EUROPE

THE UNITED KINGDOM/IRELAND

Yamaha Music Europe GmbH (UK)
Sherbourne Drive, Tilbrook, Milton Keynes,
MK7 8BL, U.K.
Tel: +44-1908-366700

GERMANY

Yamaha Music Europe GmbH
Siemensstrasse 22-34, 25462 Rellingen, Germany
Tel: +49-4101-303-0

SWITZERLAND/LIECHTENSTEIN

**Yamaha Music Europe GmbH, Branch Switzerland in
Thalwil**
Seestrasse 18a, 8800 Thalwil, Switzerland
Tel: +41-44-3878080

AUSTRIA/BULGARIA/ CZECH REPUBLIC/HUNGARY/ ROMANIA/SLOVAKIA/SLOVENIA

**Yamaha Music Europe GmbH
Branch Austria**
Schleiergasse 20, 1100 Wien, Austria
Tel: +43-1-60203900

POLAND/LITHUANIA/LATVIA/ESTONIA

**Yamaha Music Europe GmbH
Sp.z o.o. Oddział w Polsce**
ul. Wielicka 52, 02-657 Warszawa, Poland
Tel: +48-22-880-08-88

MALTA

Olimpus Music Ltd.
Valletta Road, Mosta MST9010, Malta
Tel: +356-2133-2093

NETHERLANDS/BELGIUM/LUXEMBOURG

Yamaha Music Europe Branch Benelux
Clarissenhof 5b, 4133 AB Vianen, The Netherlands
Tel: +31-347-358040

FRANCE

Yamaha Music Europe
7 rue Ambroise Croizat, Zone d'activités de Pariest,
77183 Croissy-Beaubourg, France
Tel: +33-1-6461-4000

ITALY

Yamaha Music Europe GmbH, Branch Italy
Via Tinelli N.67/69 20855 Gerno di Lesmo (MB), Italy
Tel: +39-039-9065-1

SPAIN/PORTUGAL

**Yamaha Music Europe GmbH Ibérica, Sucursal en
España**
Ctra. de la Coruna km. 17,200, 28231
Las Rozas de Madrid, Spain
Tel: +34-91-639-88-88

GREECE

Philippos Nakas S.A. The Music House
19th klm. Leof. Lavriou 190 02 Peania – Attiki, Greece
Tel: +30-210-6686168

SWEDEN/FINLAND/ICELAND

**Yamaha Music Europe GmbH Germany filial
Scandinavia**
JA Wettergrensgata 1, 400 43 Göteborg, Sweden
Tel: +46-31-89-34-00

DENMARK

**Yamaha Music Denmark,
Fillial of Yamaha Music Europe GmbH, Tyskland**
Generatorvej 8C, ST. TH. , 2860 Søborg, Denmark
Tel: +45-44-92-49-00

NORWAY

**Yamaha Music Europe GmbH Germany -
Norwegian Branch**
Grini Næringspark 1, 1332 Østerås, Norway
Tel: +47-6716-7800

RUSSIA

Yamaha Music (Russia) LLC.
Room 37, entrance 7, bld. 7, Kievskaya street, Moscow,
121059, Russia
Tel: +7-495-626-5005

OTHER EUROPEAN COUNTRIES

Yamaha Music Europe GmbH
Siemensstrasse 22-34, 25462 Rellingen, Germany
Tel: +49-4101-3030

AFRICA

Yamaha Music Gulf FZE
JAFZA-16, Office 512, P.O.Box 17328,
Jebel Ali FZE, Dubai, UAE
Tel: +971-4-801-1500

MIDDLE EAST

TURKEY

**Yamaha Music Europe GmbH
Merkezi Almanya Türkiye İstanbul Şubesi**
Maslak Meydan Sodak, Spring Giz Plaza Bagimsiz Böl.
No:3, Sariyer Istanbul, Turkey
Tel: +90-212-999-8010

CYPRUS

Yamaha Music Europe GmbH
Siemensstrasse 22-34, 25462 Rellingen, Germany
Tel: +49-4101-303-0

OTHER COUNTRIES

Yamaha Music Gulf FZE
JAFZA-16, Office 512, P.O.Box 17328,
Jebel Ali FZE, Dubai, UAE
Tel: +971-4-801-1500

ASIA

THE PEOPLE'S REPUBLIC OF CHINA

Yamaha Music & Electronics (China) Co.,Ltd.
2F, Yunhedasha, 1818 Xinzha-lu, Jingan-qu,
Shanghai, China
Tel: +86-400-051-7700

INDIA

Yamaha Music India Private Limited
P-401, JMD Megapolis, Sector-48, Sohna Road,
Gurgaon-122018, Haryana, India
Tel: +91-124-485-3300

INDONESIA

PT. Yamaha Musik Indonesia (Distributor)
Yamaha Music Center Bldg. Jalan Jend. Gatot Subroto Kav.
4, Jakarta 12930, Indonesia
Tel: +62-21-520-2577

KOREA

Yamaha Music Korea Ltd.
8F, Dongsung Bldg. 21, Teheran-ro 87-gil, Gangnam-gu,
Seoul, 06169, Korea
Tel: +82-2-3467-3300

MALAYSIA

Yamaha Music (Malaysia) Sdn. Bhd.
No.8, Jalan Perbandaran, Kelana Jaya, 47301
Petaling Jaya, Selangor, Malaysia
Tel: +60-3-78030900

SINGAPORE

Yamaha Music (Asia) Private Limited
Block 202 Hougang Street 21, #02-00,
Singapore 530202, Singapore
Tel: +65-6740-9200

TAIWAN

Yamaha Music & Electronics Taiwan Co.,Ltd.
2F, No.1, Yuandong Rd., Banqiao Dist.,
New Taipei City 22063, Taiwan (R.O.C.)
Tel: +886-2-7741-8888

THAILAND

Siam Music Yamaha Co., Ltd.
3, 4, 15, 16th Fl., Siam Motors Building,
891/1 Rama 1 Road, Wangmai,
Pathumwan, Bangkok 10330, Thailand
Tel: +66-2215-2622

VIETNAM

Yamaha Music Vietnam Company Limited
15th Floor, Nam A Bank Tower, 201-203 Cach Mang Thang
Tam St., Ward 4, Dist.3,
Ho Chi Minh City, Vietnam
Tel: +84-8-3818-1122

OTHER ASIAN COUNTRIES

**Yamaha Corporation
Sales & Marketing Division**
10-1, Nakazawa-cho, Naka-ku, Hamamatsu,
Japan 430-8650
Tel: +81-53-460-2312

OCEANIA

AUSTRALIA

Yamaha Music Australia Pty. Ltd.
Level 1, 99 Queensbridge Street, Southbank,
VIC 3006, Australia
Tel: +61-3-9693-5111

COUNTRIES AND TRUST TERRITORIES IN PACIFIC OCEAN

**Yamaha Corporation
Sales & Marketing Division**
10-1, Nakazawa-cho, Naka-ku, Hamamatsu,
Japan 430-8650
Tel: +81-53-460-2312