



USER MANUAL

AH110

AH112

AH115



WWW.LANEY.CO.UK

DESIGNED & ENGINEERED IN THE UK BY LANEY

Welcome

Dear Player,

Thank you very much for purchasing your new Laney product and becoming part of the worldwide Laney family. Each and every Laney unit is designed and built with the utmost attention to care and detail, so I trust yours will give you many years of enjoyment.

Laney products have a heritage which stretches back to 1967 when I first began building valve amplifiers in my parent's garage.

Since then we have moved on from strength to strength developing an extensive range of guitar, bass, public address, multi instrument and keyboard amplification products along with a list of Laney endorsees that includes some of the world's most famous and respected musicians.

At the same time we believe we have not lost sight of the reason Laney was founded in the first place - a dedication to building great sounding amplification for working musicians.

Warm Regards,

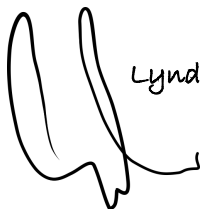
A handwritten signature in black ink, consisting of a large, stylized 'L' followed by a horizontal line and a small flourish.

Lyndon Laney Chairman & Founder

Introduction

The Laney Audiohub Venue range of enclosures is designed for high performance in a wide variety of demanding audio applications.

The Audiohub Venue range is ideally suited for uses in classrooms, business seminars and presentations, worship meets, parties, bars, BBQ's and musical performances.

Housing a flexible on-board mixer which includes a Bluetooth® equipped media player, each Audiohub Venue gives you a compact yet flexible solution to your audio sound reinforcement requirements. These lightweight, portable, full range moulded enclosures, can be either floor standing, mounted on a pole or tripod stand (via the 35mm pole socket), or lay on their side to be used as a wedge monitor (AH112 and AH115 only).

This manual contains important information regarding correct and safe operation of your active system. Please read it thoroughly in order to get the best performance and reliability from your new Laney product.

AH110



AH112



AH115



Applications

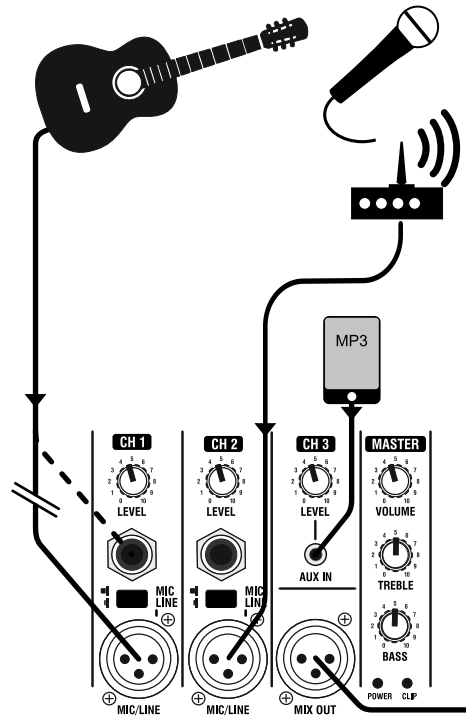

AUDIOHUB
rear panel

Solo performance.

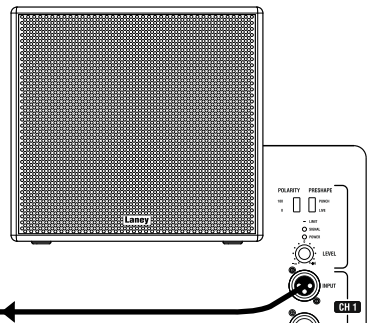

AUDIOSUB
rear panel

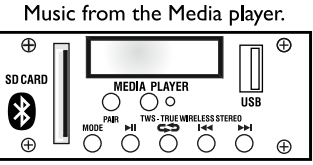

Music from the Media player.
Connection and control of a Bluetooth device using the Media player.

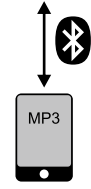

Dance class.

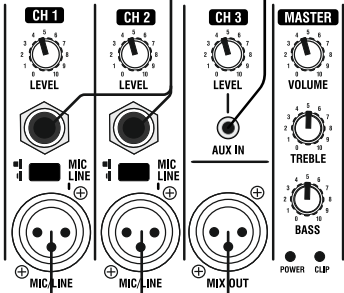
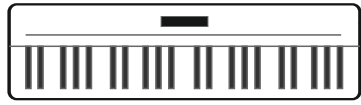

Stage performance.

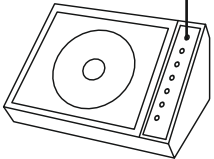

Daisy chaining.

Any number of AudioHubs can be connected in this way.
 Initially set CH1 LEVEL control for AH1 to zero.
 Set the CH1 LEVEL for AH2 and AH3 to 5.
 Slowly turn up the CH1 LEVEL control on the AH1 to achieve the desired level.

Please note: if an additional audio feed is connected to AH2, it will only be heard from AH2 and AH3, **NOT** AH1.

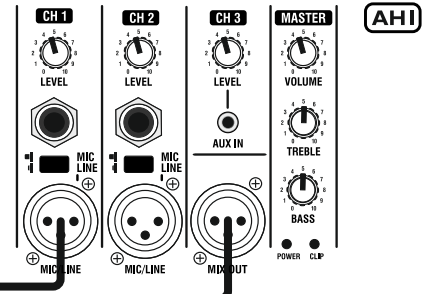

AH1

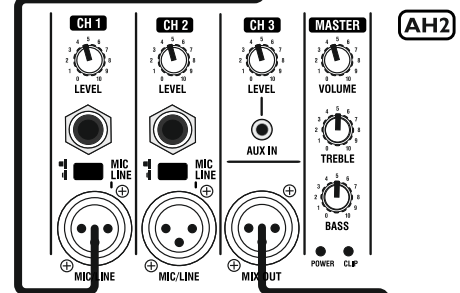

AH2

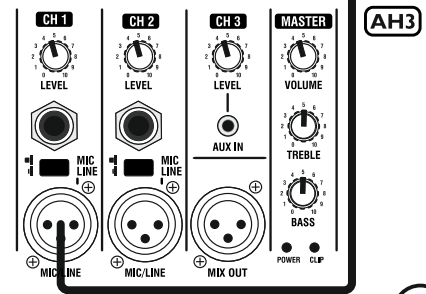

AH3

Media Player Controls

MEDIA PLAYER:

Use the media player for playing back MP3/WMA encoded audio tracks from SD card/USB or Bluetooth device.

1. SD CARD SLOT: Insert your standard SD card here.

(Automatically detected on insertion, or if removed and reinserted uses smart technology to resume play from the previous point).

2. DISPLAY SCREEN: Display track information.

- Pause or Play indicator.
- What device is being used: USB or SD Card.
- Time into track.
- “blue” is displayed when using a Bluetooth Device.

3. MEMORY STICK SLOT: Connect your USB memory stick here.

(Automatically detected on insertion, or if removed & reinserted uses smart technology to resume play from the previous point).

NOTE: The USB socket is for the playback of recorded tracks only, not for charging a USB device.

4. Pair: Press the pair button to enable Bluetooth pairing, it should now be visible to your Bluetooth device.

5. TWS. The TWS (True Wireless Stereo) button is used to link two cabinets together. Press TWS on the first cabinet, the led flashes blue/green, press the TWS button on the second cabinet, they will find each other and the led changes to blue followed by a confirmation noise. The cabinets are now linked and anything played via Bluetooth, or on the media player will be sent to both speakers.
Hold the TWS button to unlink the device.

(NOTE. CH1/2 are not sent wirelessly and are routed only to the onboard speaker).

6. MODE: Select the input source - SD card USB or Bluetooth.

7. PLAY/PAUSE: Use this control to play or pause your MP3 music/backing track.

8. LOOP: Use this to enable/disable the looped playback modes. When using this button with an SD card or USB Stick, there are 4 options:

- ALL** - Plays all the tracks on the root of the device in date order, then the sub folders
- FOLDER** - Plays all the tracks in the chosen folder
- ONE** - Plays one track repeatedly (cycle to the required track to play using **NEXT** button (10).
- RANDOM** - Plays tracks randomly

9. PREVIOUS: Press to skip to the preceding track.

10. NEXT: Press to skip to the next track.

a. CONNECT TO Bluetooth DEVICE: Toggle through the system modes and select Bluetooth (using MODE switch (6)).

b. On your Bluetooth capable device, make sure Bluetooth is enabled. Scan down the list of available devices - search for: **Laney Audiohub** and select.

c. Your AudioHub is now connected to your Bluetooth device & controlled using the **PLAY/PAUSE, PREVIOUS & NEXT BUTTONS**

d. Switching between a USB device and a Bluetooth device is possible, but the Bluetooth device will need to be re-selected by pressing the **MODE** button once.

Only one Audiohub can be paired to your Bluetooth capable device at once, so remember to de-select & forget a device if you plan to use a different Audiohub device next time.

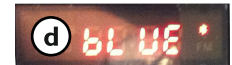
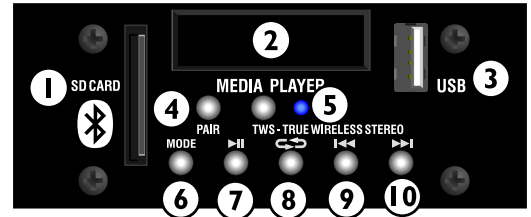

Rear Panel Controls

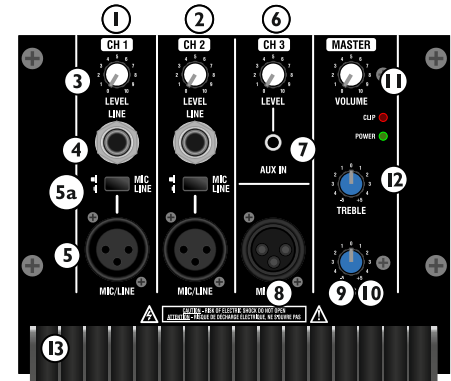

1/2. CH1 & CH2: Mono Input channels.

3. LEVEL: Use the Level control to set the channel volume.

4. LINE INPUT: An unbalanced input - for higher output line level devices eg. - keyboard, processor, drum machine.

5/5a. MIC/LINE INPUT: Use the push button (5a) to switch the XLR Skt between:

MIC: a balanced input for low level, low impedance devices eg. -mic (200-600ohms) or electro-acoustic guitar.

LINE: a balanced input for higher output line level devices eg. -sub or mixer.

6. CH3 LEVEL: Use this control to adjust the level of the onboard USB/SD player or an external (line level) signal feed connected to the AUX IN.

7. AUX IN: This gives you the option to connect an additional line level device. Control the Level with Level control ⑩. Please use a stereo cable.

8. MIX OUT: A BALANCED signal feed that is picked up before the power amp stage. This can be used to connect to a second AudioHub cab (daisy chained), active wedge monitor, house PA or mixing console for example.

9. POWER LED: This will illuminate when the unit is powered up. There is also a second power LED on the front of the cab which will illuminate to indicate that power is present.

10. CLIP LED: Illuminates just before the amplifier begins to clip. Adjust the level controls and signal level from your source so this illuminates only briefly on peaks in the music.

11. MASTER VOLUME: Controls the overall level of your AudioHub.

12. Active BASS and TREBLE: These controls allow you to boost or cut the low/high frequency response of the amplifier.

13. HEAT SINK: Cooling fins for the amplifier. Do not obstruct.

14. MAINS SWITCH: Turns the system on and off. Ensure the level controls are at minimum when switching on and off.

15. INFORMATION: Area relating to the amplifier: Serial Number, operational information, power rating, etc.

16. MAINS INLET SOCKET AND FUSE: IEC input for connection of an appropriate mains lead. Only replace fuse with the type indicated for your mains voltage.

Setting the mains voltage:

The Voltage selection is made via the fuse holder. To change the voltage, slide out the fuse holder and rotate to achieve the correct voltage selection for your country.

Note:

Pay special attention when selecting the voltage because incorrect voltage assignment could cause damage to your AudioHub!

Block Diagram

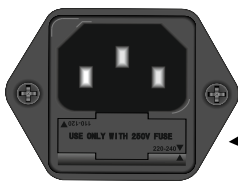
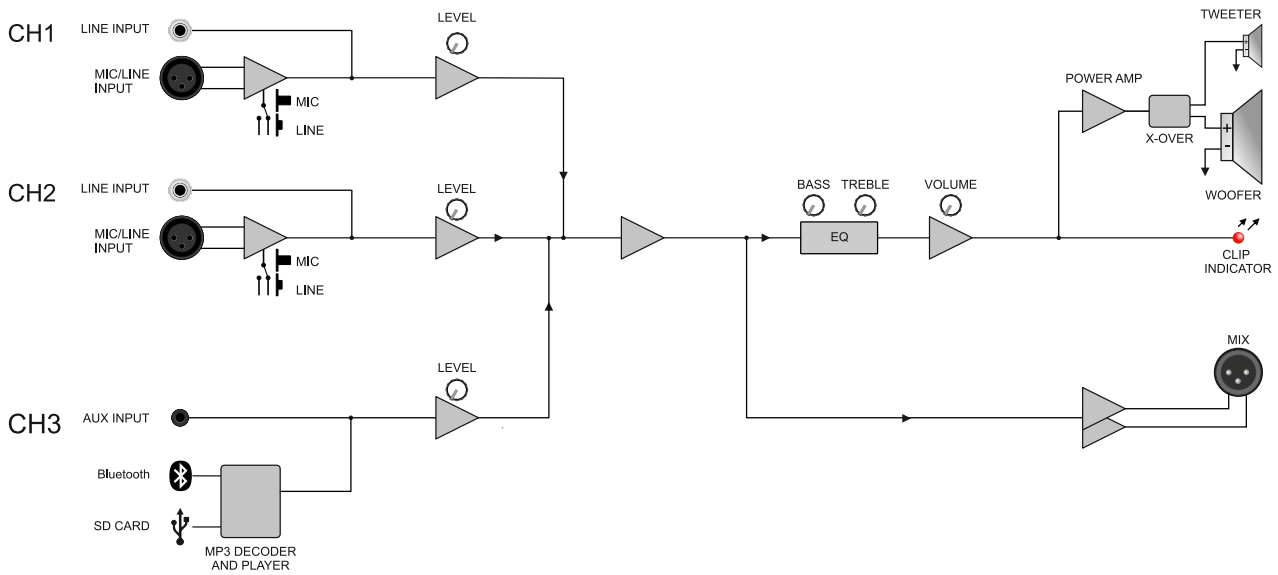

Slide out fuse holder.

110-120V - Operation



Fuse type:
F3.15A L 250V

220-240V - Operation



Fuse type:
F2.5A L 250V

Alignment of triangles indicates selected voltage.

Always switch off and disconnect the power cord when not in use.

Dimensions and mounting

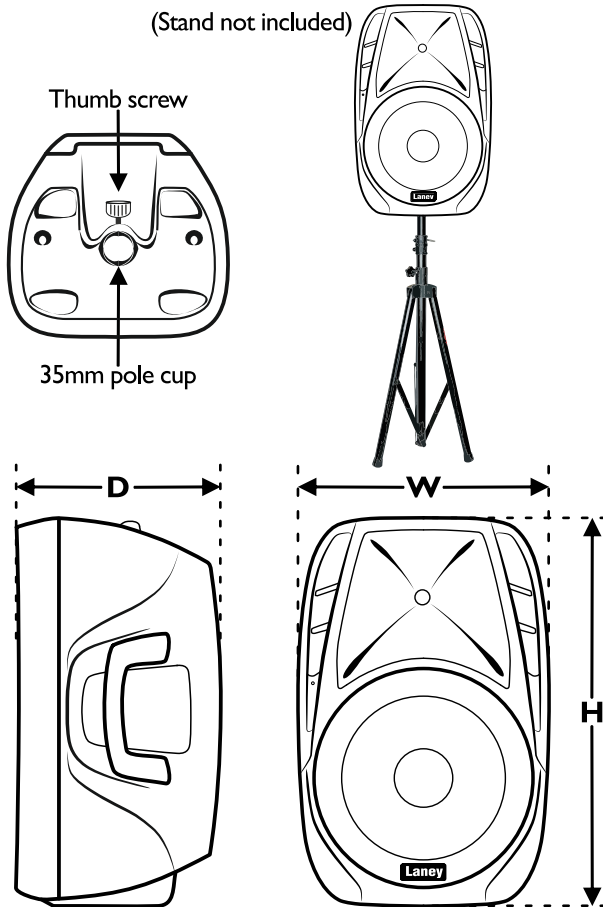

All cabinets should be balanced and steady.

Don't over-extend poles/tripods; ensure at least 4 x the pole diameter is still inside the outer pole.

Make sure the legs have a good splay on tripods, but do not obstruct doorways or other access-ways.

If a pole mount is used, make sure that the thumb screw on the cabinet is tight.

Keep lights away from speakers; heat can cause fires / speaker damage.

Don't run cables across access-ways; if you have to, run them above doors or use approved cable covers.

Be aware of total power usage. Overloading a mains socket is potentially dangerous, and likely to cause a power out during use.

Keep lighting cables away from ALL sound cables including mains, use separate circuit for lights if possible.

Keep power and signal cables apart.

| MODEL | DEPTH (D) | WIDTH (W) | HEIGHT (H) | WEIGHT (KG) |
|----------------|-----------|-----------|------------|-------------|
| AH110 (actual) | 315 | 265 | 490 | 11.5 |
| AH110 (boxed) | 355 | 295 | 545 | 12.0 |
| AH112 (actual) | 375 | 310 | 585 | 13.0 |
| AH112 (boxed) | 420 | 341 | 628 | 14.0 |
| AH115 (actual) | 465 | 380 | 715 | 15.0 |
| AH115 (boxed) | 485 | 400 | 740 | 16.0 |

(All dimensions in mm's)

Specifications

| | | | |
|--------------------------|---|---|---|
| Maximum output: | 400W | 800W | 800W |
| Frequency range: | 20Hz-20kHz | 20Hz-20kHz | 20Hz-20kHz |
| Woofer | 10" | 12" | 15" |
| Tweeter | 1" compression driver | 1" compression driver | 1" compression driver |
| Power Consumption: | 160Watts (maximum) | 320Watts (maximum) | 320Watts (maximum) |
| Operating Voltage Range: | ~100V - (Factory option) ~120V or 220V/230V/240V | ~100V - (Factory option) ~120V or 220V/230V/240V | ~100V - (Factory option) ~120V or 220V/230V/240V |
| Fuse: | ~110V-120V - F3.15A L250V ~220V-240V - F2.5A L250V | ~110V-120V - F3.15A L250V ~220V-240V - F2.5A L250V | ~110V-120V - F3.15A L250V ~220V-240V - F2.5A L250V |
| Mic/Line Input: | Balanced 2K2 Ohm | | |
| Mic Sensitivity: | -33dBu (15mV) (nominal) | | |
| Line Input: | Unbalanced 10K Ohm | | |
| Line Sensitivity: | 0dBu (0.75V) (nominal) | | |
| MIX Out: | -10dBu (0.35V) Nominal | | |

Connector wiring:

6.35mm Unbalanced Jack

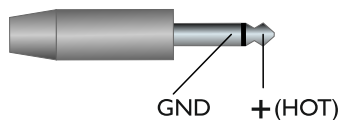

3.5mm Stereo Jack

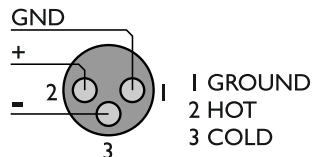
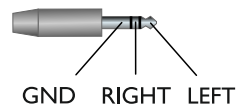



USER MANUAL

TRANSLATIONS

WWW.LANEY.CO.UK

DESIGNED & ENGINEERED IN THE UK BY LANEY

REPRODUCTOR MULTIMEDIA:

- 1. RANURA PARA TARJETA SD:** Inserte su tarjeta estándar SD aquí.
- 2. DISPLAY SCREEN:** Visualiza información de la pista.
- 3. RANURA MEMORY STICK:** Conecte su memory stick USB aquí.
Nota. El zócalo del USB está para la reproducción de pistas grabadas solamente, no para cargar un dispositivo del USB.
- 4. PAIR.** Pulse el botón pair para activar el emparejamiento Bluetooth, ahora debe estar visible en el dispositivo Bluetooth.
- 5. TWS.** El botón TWS (true Wireless Stereo) se utiliza para unir dos gabinetes. Presione TWS en el primer gabinete, el LED destella azul/verde. Presione el botón TWS en el segundo gabinete, se encontrarán y el LED cambiará a azul seguido de un ruido de confirmación. Los archivadores están ahora conectados y cualquier cosa que se reproduzca a través de Bluetooth, o en el reproductor multimedia se enviará a ambos altavoces. Sostenga el botón TWS para desenlazar el dispositivo.

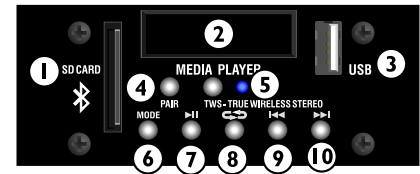

- Nota. CH1/2 no se envían de forma inalámbrica y sólo se rutean al altavoz onboard)*
- 6. MODE:** Seleccione la fuente de entrada – tarjeta SD, USB o Bluetooth® y desconecte el reproductor.
 - 7. PLAY/PAUSE:** Utilice este control para reproducir o pausar la música MP3/pista de acompañamiento.
 - 8. LOOP:** Utilícelo para activar/desactivar los modos de reproducción en bucle. Al utilizar este botón con una tarjeta SD o un stick USB, hay 4 opciones:
 - Todo** - reproduce todas las pistas en la raíz del dispositivo en orden de la fecha, entonces las subcarpetas
 - Carpeta** - reproduce todas las pistas de la carpeta elegida
 - One** - reproduce una pista repetidamente (cicla a la pista requerida para jugar usando el botón Next (10).
 - Random** - reproduce pistas aleatoriamente
 - 9. REWIND:** Pulse para saltar a la pista anterior.
 - 10. FORWARD:** Pulse para saltar a la siguiente pista.

CONTROLES DEL PANEL TRASERO

- 1&2. CH1 & CH2:** Canales de entrada mono.
- 3. LEVEL:** Controla el nivel de volumen para cada canal
- 4. LINE:** Entrada no balanceada – para dispositivos con niveles de salida altos por ejemplo teclado, procesados, caja de ritmos, etc.
- 5/5a. Entrada MIC/LINE:** Utilice el pulsador (5A) para cambiar el XLR SCT entre:
MIC: una entrada balanceada para los dispositivos bajos de la impedancia del nivel, eg. -MIC (200-600ohms) o guitarra electroacústica.
Línea: una entrada balanceada para dispositivos de nivel de línea de salida más altos EG. -sub o mezclador.
- 6. CH3 LEVEL:** Use este control para ajustar el nivel del reproductor integrado USB/SD o un canal de señal externa (nivel de línea) conectada a la toma AUX IN.
- 7. AUX IN:** Esto le da la opción de conectar un dispositivo adicional de nivel de línea. Controle el nivel con el control Level. Por favor, use un cable estéreo.
- 8. MIX OUT:** Es una señal de alimentación balanceada que es recogida antes de la etapa del amplificador de potencia. Esto se puede utilizar para conectarse a un segundo AudioHub (daisy chained), monitor de escenario activo, PA casero o mesa de mezclas por ejemplo.
- 9. POWER LED:** Se ilumina cuando la unidad está encendida. Hay un Segundo LED en la parte delantera para indicar que hay corriente.
- 10. CLIP LED:** Se enciende justo antes de que el amplificador empiece a saturar. Ajuste los controles de nivel y nivel de la señal para que este LED se ilumine brevemente en los picos de la música.
- 11. MASTER VOLUME:** Controla el nivel general de su AudioHub.
- 12. BASS y TREBLE activos:** Estos controles te permiten acentuar o reducir la respuesta de frecuencias graves/agudas del amplificador.
- 13. DISIPADOR DE CALOR:** Permite refrigerar el amplificador. No obstruir.
- 14. INTERRUPTOR PRINCIPAL:** Enciende y apaga el sistema. Asegúrese de que los controles de nivel están al mínimo al encender y apagar.
- 15. INFORMACIÓN:** Área relacionada con el amplificador: Número de serie, la información operativa, potencia, etc.
- 16. TOMA DE RED Y FUSIBLE:** Entrada IEC para conectar con el cable apropiado. Reemplace el fusible solo por uno apropiado para el voltaje utilizado.

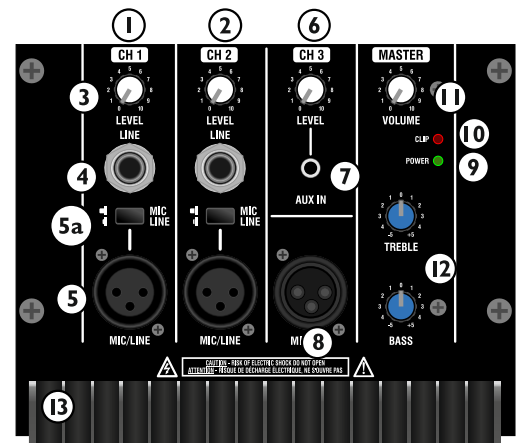

- a. Conecte con el dispositivo Bluetooth:** conmute a través de los modos de sistema y seleccione Bluetooth (usando el interruptor de modo (6)).
- b.** en el dispositivo con capacidad Bluetooth, asegúrese de que Bluetooth esté habilitado. Explore la lista de dispositivos disponibles-busque: Laney Audiohub y SELECT.
- c.** su AudioHub está ahora conectado a su dispositivo Bluetooth y controlado usando los botones Reproducir/pausa, anterior y siguiente
- d.** es posible cambiar entre un dispositivo USB y un dispositivo Bluetooth, pero es necesario volver a seleccionar el dispositivo Bluetooth presionando el botón MODE una vez. Sólo un Audiohub puede ser emparejado a su dispositivo Bluetooth capaz a la vez, así que recuerde de-seleccionar y olvidar un dispositivo si usted planea utilizar un dispositivo Audiohub diferente la próxima vez.



Nota: Preste especial atención al seleccionar el voltaje, una selección incorrecta puede causar daños a su AudioHub

LECTEUR MULTIMÉDIA

1. **SD CARD:** Insérez votre Carte SD dans cette fente (l'insertion est détectée automatiquement. Si la carte est retirée puis ré-insérée, la lecture continue là où elle s'est arrêtée).
 2. **Afficheur:** Infos sur la piste.
 - a. Indicateur de lecture ou pause
 - b. **Indicateur de périphérique:** USB ou SD
 - c. Temps de la piste en cours
 - d. "bLUE" est affiché lors de l'utilisation d'un appareil Bluetooth®.
3. **USB:** Insérez votre clé USB dans cette fente (l'insertion est détectée automatiquement. Si la carte est retirée puis ré-insérée, la lecture continue là où elle s'est arrêtée).

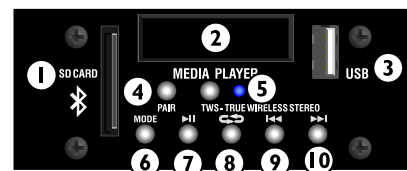

NOTE: Cette prise USB est destinée à la lecture de morceaux et non pas pour charger un appareil USB.

4. **Pair:** Appuyez sur le bouton "pair" pour activer la liaison Bluetooth et être visible sur votre appareil Bluetooth.
5. **TWS:** Le bouton TWS (True Wireless Stereo) permet de lier deux enceintes. Appuyez sur TWS sur la première enceinte pour faire clignoter le voyant en bleu et vert. Appuyez sur le bouton TWS de la deuxième enceinte pour qu'elles se synchronisent l'une avec l'autre. Le voyant passe alors au bleu et un son confirme la liaison. Les enceintes sont alors synchronisées et n'importe quel son envoyé par Bluetooth ou par le lecteur sera envoyé vers les deux enceintes. Appuyez longtemps sur le bouton TWS pour délier les enceintes.

(NOTE: Les canaux 1/2 ne sont pas envoyés sans fil et sont envoyés uniquement vers le HP interne)
6. **MODE:** Sélectionne la source en entrée - Carte SD, USB ou Bluetooth
7. **PLAY/PAUSE:** Cette fonction permet de jouer ou de mettre en pause votre piste MP3.
8. **LOOP:** Cette fonction permet d'activer / désactiver les modes de lecture en boucle. Quatre options sont possibles avec une carte SD ou une clé USB:
 - ALL** - Joue tous les morceaux de la racine de la source par ordre de date, puis les morceaux des sous-dossiers.
 - FOLDER** - Joue tous les morceaux du dossier sélectionné.
 - ONE** - Joue et répète un morceau en continu (passez à la piste désirée à l'aide du bouton NEXT (10)).
 - RANDOM** - Joue les morceaux choisis aléatoirement.
9. **Précédent:** Appuyez sur pour passer à la piste précédente.
10. **Suivant:** Appuyez sur pour passer à la piste suivante.

CONTRÔLES DU PANNEAU ARRIÈRE

- 1/2. **CH1 & CH2:** Canaux d'entrée mono.
3. **LEVEL:** Contrôle le niveau du canal.
4. **LINE:** Entrée asymétrique pour source de niveau ligne tels que clavier, boîte à rythme, etc.
- 5/5a. **Entrée MIC/LINE:** A l'aide du bouton poussoir (5a), sélectionnez l'entrée XLR entre :
 - MIC:** entrée symétrique pour une source de niveau faible, basse impédance, telle que micro (200-600ohms) ou guitare électro-acoustique.
 - LINE:** Entrée symétrique pour une source de niveau ligne telle qu'un sub ou une table de mixage.
6. **CH3 LEVEL:** Ajuste le niveau du lecteur USB/SD intégré ou le signal entrant dans la prise AUX IN.
7. **AUX IN:** Permet de brancher une source de niveau ligne supplémentaire. Contrôlez son niveau avec le bouton (14). N'utilisez qu'un câble stéréo.
8. **MIX OUT:** Sortie symétrique prélevée avant l'étage ampli pour envoyer vers un deuxième AudioHub (chaînage), une enceinte active, une sono ou une table de mixage.
9. **POWER:** Ce voyant s'allume lorsque l'Vector est en marche. Il y a un deuxième voyant à l'avant de l'enceinte avec la même fonction.
10. **CLIP:** Ce voyant s'allume juste avant l'écrêtage de l'ampli. Ajustez les niveaux de vos sources pour qu'il ne clignote qu'occasionnellement.
11. **MASTERVOLUME:** Contrôle le niveau général de l'AudioHub.
12. **BASS & TREBLE:** Contrôles actifs pour augmenter ou diminuer les fréquences graves et aiguës.
13. **REFROIDISSEUR:** Ailettes de refroidissement de l'ampli. Ne pas obstruer.
14. **POWER:** Interrupteur général M/A. Vérifiez que tous les contrôles soient au minimum lorsque vous mettez en marche ou coupez l'appareil.
15. **INFORMATION:** Données de l'ampli: numéro de série, infos de fonctionnement, puissance, etc.
16. **PRISE D'ALIMENTATION:** Prise pour le câble d'alimentation secteur avec tiroir à fusible. Ne remplacez les fusibles qu'avec le même type indiqué pour votre secteur.

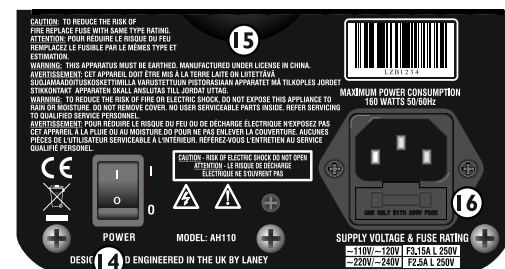
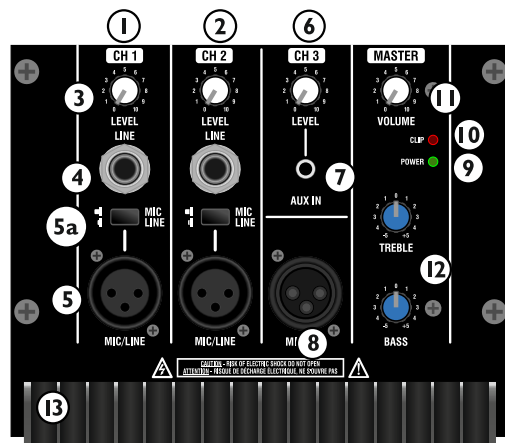

Liaison avec un appareil Bluetooth® :

- a. connexion au périphérique Bluetooth: commuter dans les modes système et sélectionner Bluetooth (en utilisant le sélecteur de mode (6)).
- b. sur votre appareil compatible Bluetooth, assurez-vous que Bluetooth est activé. Numériser la liste des périphériques disponibles-recherchez: Laney AudioHub et sélectionnez.
- c. votre AudioHub est maintenant connecté à votre appareil Bluetooth et contrôlé à l'aide des boutons lecture/pause, précédent et suivant
- d. la commutation entre un périphérique USB et un périphérique Bluetooth est possible, mais le périphérique Bluetooth doit être resélectionné en appuyant une fois sur le bouton mode. Une seule AudioHub peut être jumelée à votre appareil Bluetooth à la fois, alors n'oubliez pas de désélectionner et d'oublier un périphérique si vous prévoyez d'utiliser un autre périphérique AudioHub la prochaine fois.



媒体播放器

1. SD卡插槽：在这里插入标准的SD卡。
2. MP3显示屏：显示曲目信息。
3. USB插槽：此处连接USB。
4. 模式选择：选择输入源 - SD卡/USB或蓝牙和关闭播放器。
 - 连接 蓝牙设备：（使用MODE开关）通过系统切换模式，选择蓝牙模式。
 - 在您的蓝牙功能的设备，确保蓝牙已启用。扫描下来可用设备列表 - 搜索蓝牙名称Laney AUDIOHUB。
 - 连接到您的蓝牙设备。

注意. usb 插座只用于播放录制的曲目，而不是为 usb 设备充电。

5. 按下配对按钮以启用蓝牙配对，它现在应该可以在您的蓝牙设备上看到。
6. TWS. TWS（真正的无线立体声）按钮用于将两个机柜连接在一起。在第一个机柜上按 TWS，指示灯呈蓝色/绿色闪烁。按下第二个机柜上的 TWS 按钮，他们会发现对方，然后将指示灯变为蓝色，然后是确认噪音。现在，文件柜被链接，任何通过蓝牙播放的东西，或媒体播放器将被发送到两个扬声器。

按住 TWS 按钮取消设备的链接。

注意.CH1/2 不是以无线方式发送的，只发送给板上扬声器)

7. 播放 / 暂停：使用此控件播放或暂停MP3音乐。
8. 循环：使用此功能可以启用/禁用环形回放模式。当使用 SD 卡或 u盘的这个按钮时，有4选项：
 - 全部-按日期顺序播放设备根目录上的所有曲目，然后子文件夹
 - 文件夹-在所选文件夹中播放所有曲目
 - 一-播放一个曲目重复（循环到所需的曲目使用 NEXT 按钮（10）。
 - 随机播放曲目随机
9. 上一曲：按跳到上一首曲目。
10. 下一曲：按跳到下一首曲目。

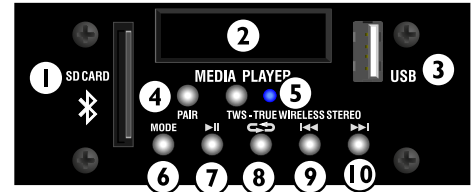

后面板控件

- 1/2 声道1和2：控制该通道输入音量大小。
3. 音量水平：控制该通道输入音量大小。
4. 单通道线性输入：用来连接乐器或其他外设，如麦克风（200-600欧姆），键盘，处理器，鼓机信号等
- 5/5a. 麦克风/线路输入：使用按钮（5a）在 XLR和SKT 之间切换：
 - 麦克风输入：低信号输出低阻抗设备的平衡输入插孔，例如，麦克风（200-600ohms）或电声吉它等。
 - 线路输入：高信号输出高阻抗设备的平衡输入插孔，例如，重低音或调音台等。
6. 声道音量水平：使用此控制调节板载USB / SD播放器或连接到AUX In外接（线路电平）信号音量大小。
7. 音频输入接口：可以从包括mp3在内的电子声频设备输出音频（一般的耳机插孔）
8. 主混音输出接口：一般用此输出连接到主要的后级设备上，例如专业音响或调音台。
9. 电源指示灯：当音箱通电时指示灯将亮起，表示音箱可以正常工作。
10. 信号峰值指示灯：如果输入信号超过可承受峰值，此指示灯亮起。
11. 主音量：控制音量总开关。
12. 高音和低音：增加或削减高低音喇叭的频率大小。
13. 散热器：辅助散热
14. 电源开关：打开和关闭电源。
15. 序列号：该机序列号
16. 主电源插座进水口和保险丝：电源插孔。注意电源电压需和箭头指示电压匹配。

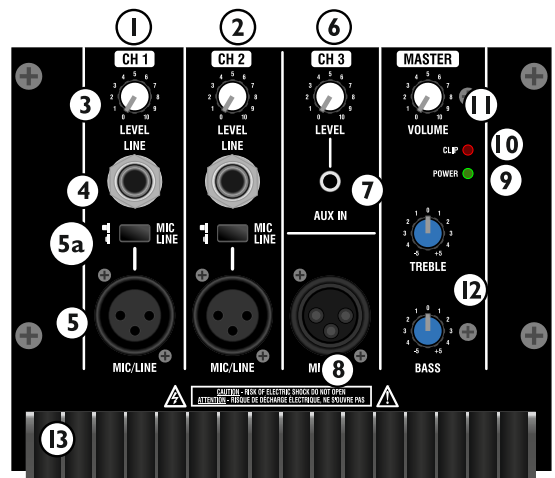

- a. 连接到蓝牙设备：切换系统模式并选择蓝牙（使用模式开关（6））。
- b. 在您的蓝牙功能设备上，确保蓝牙已启用。向下扫描可用设备列表-搜索：兰尼 Audiohub 并选择。
- c. 您的AudioHub 现在连接到您的蓝牙设备和控制使用播放/暂停，上一个和下一个按钮
- d. 在USB 设备和蓝牙设备之间切换是可能的，但是蓝牙设备需要通过按下模式按钮一次选择。

只有一个 Audiohub 可以配对到您的蓝牙功能的设备一次，所以记住取消和忘记一个设备，如果你打算使用不同的Audiohub 设备下一次。

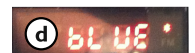



USER MANUAL

SAFETY INFORMATION

WWW.LANEY.CO.UK

DESIGNED & ENGINEERED IN THE UK BY LANEY

GENERAL INSTRUCTIONS

In order to take full advantage of your new product and enjoy long and trouble-free performance, please read this owner's manual carefully, and keep it in a safe place for future reference.

- 1) Unpacking:** On unpacking your product please check carefully for any signs of damage that may have occurred whilst in transit from the Laney factory to your dealer. In the unlikely event that there has been damage, please re-pack your unit in its original carton and consult your dealer. We strongly advise you to keep your original transit carton, since in the unlikely event that your unit should develop a fault, you will be able to return it to you dealer for rectification securely packed.
- 2) Amplifier Connection:** In order to avoid damage, it is advisable to establish and follow a pattern for turning on and off your system. With all system parts connected, turn on source equipment, tape decks, cd players, mixers, effects processors etc, BEFORE turning on your amplifier. Many products have large transient surges at turn on and off which can cause damage to your speakers. By turning on your bass amplifier LAST and making sure its level control is set to a minimum, any transients from other equipment should not reach your loud speakers. Wait till all system parts have stabilised, usually a couple of seconds. Similarly when turning off your system always turn down the level controls on your bass amplifier and then turn off its power before turning off other equipment
- 3) Cables:** Never use shielded or microphone cable for any speaker connections as this will not be substantial enough to handle the amplifier load and could cause damage to your complete system.
- 4) Servicing:** The user should not attempt to service these products. Refer all servicing to qualified service personnel.



FCC COMPLIANCE STATEMENT

This device complies with Part 15 of the FCC rules.

Operation is subject to the following two conditions:

- 1) This device may not cause harmful interference
- 2) This device must accept any interference received, that may cause undesired operation.

Warning: Changes or modification to the equipment not approved by Laney can void the user's authority to use the equipment.

Note: This equipment has been tested and found to comply with the limits for Class B digital device, pursuant to Part 15 of the FCC Rules. These limits are designed to provide reasonable protection against harmful interference in a residential installation. This equipment generates, uses and can radiate radio frequency energy and if not installed and used in accordance with the instructions, may cause harmful interference to radio communications. However, there is no guarantee that interference will not occur in a particular installation. If this equipment does cause harmful interference to radio or television reception, which can be determined by turning the equipment off and on, the user is encouraged to try and correct the interference by one or more of the following measures. Reorient or relocate the receiving antenna.

Increase the separation between the equipment and receiver.

Connect the equipment into an outlet on a circuit different from that to which the receiver is connected.

Consult the dealer or an experienced radio/TV technician for help



This product conforms to the requirements of the following European Regulations, Directives & Rules:

CE Mark (93/68/EEC), Low Voltage 2014/35/EU, EMC (2014/30/EU), RoHS (2011/65/EU), RED (2014/30/EU), ErP 2009/125/EU

SIMPLIFIED EU DECLARATION OF CONFORMITY

Hereby, Laney Electronics Ltd. declares that the radio equipment is in compliance with Directives 2014/53/EU, 2011/65/EU, 2009/125/EU

Full text of the EU declaration of conformity is available at the following internet address:

support.laney.co.uk/approvals



In order to reduce environmental damage, at the end of its useful life, this product must not be disposed of along with normal household waste to landfill sites. It must be taken to an approved recycling centre according to the recommendations of the WEEE (Waste Electrical and Electronic Equipment) directive applicable in your country.

The Bluetooth® word mark and logos are registered trademarks owned by the Bluetooth SIG, Inc. and any use of such marks by Headstock Distribution Ltd is under license. Other trademarks and trade names are those of their respective owners. Laney is a registered trademark of Headstock Distribution Ltd.

INCORPORATED RADIO EQUIPMENT DEVICE TECHNICAL SPECIFICATION:

| | |
|-----------------------|---------------|
| Frequency Range: | 2402-2480MHz |
| Transmit Power: | +8dBm (6.3mW) |
| Receiver Sensitivity: | -91dBm |

IMPORTANT SAFETY INSTRUCTIONS



WARNING: When using electrical products, basic cautions should always be followed, including the following:

1. Read these instructions.
2. Keep these instructions safe.
3. Heed all warnings.
4. Follow all instructions.
5. Do not use this apparatus near water.
6. Clean only with a dry cloth.
7. Do not block any of the ventilation openings. Install in accordance with manufacturer's instructions.
8. Do not install near any heat sources such as radiators, heat registers, stoves or other apparatus (including amplifiers) that produce heat.
9. An apparatus with Class I construction shall be connected to a mains socket outlet with a protective connection. Do not defeat the safety purpose of the polarized or grounding-type plug. A polarized plug has two blades with one wider than the other. A grounding type plug has two blades and a third grounding prong. The wide blade or third prong is provided for your safety. If the provided plug does not fit into your outlet, consult an electrician for replacement of the obsolete outlet.
10. Protect the power cord from being walked on or pinched, particularly at plugs, convenience receptacles, and the point they exit from the apparatus.
11. Only use attachments/accessories provided by the manufacturer.
12. Use only with a cart, stand, tripod, bracket, or table specified by the manufacturer, or sold with the apparatus. When a cart is used, use caution when moving the cart/apparatus combination to avoid injury from tip-over.
13. The mains plug or appliance coupler is used as the disconnect device and shall remain readily operable. The user should allow easy access to any mains plug, mains coupler and mains switch used in conjunction with this unit thus making it readily operable. Unplug this apparatus during lightning storms or when unused for long periods of time.
14. Refer all servicing to qualified service personnel. Servicing is required when the apparatus has been damaged in any way, such as when power-supply cord or plug is damaged, liquid has been spilled or objects have fallen into the apparatus, the apparatus has been exposed to rain or moisture, does not operate normally, or has been dropped.
15. Never break off the ground pin. Connect only to a power supply of the type marked on the unit adjacent to the power supply cord.
16. If this product is to be mounted in an equipment rack, rear support should be provided.
17. Note for UK only: If the colours of the wires in the mains lead of this unit do not correspond with the terminals in your plug, proceed as follows:
 - a) The wire that is coloured green and yellow must be connected to the terminal that is marked by the letter E, the earth symbol, coloured green or coloured green and yellow.
 - b) The wire that is coloured blue must be connected to the terminal that is marked with the letter N or the colour black.
 - c) The wire that is coloured brown must be connected to the terminal that is marked with the letter L or the colour red.
18. This electrical apparatus should not be exposed to dripping or splashing and care should be taken not to place objects containing liquids, such as vases, upon the apparatus.
19. Exposure to extremely high noise levels may cause a permanent hearing loss. Individuals vary considerably in susceptibility to noise-induced hearing loss, but nearly everyone will lose some hearing if exposed to sufficiently intense noise for a sufficient time. The U.S. Government's Occupational Safety and Health Administration (OSHA) has specified the following permissible noise level exposures: According to OSHA, any exposure in excess of the above permissible limits could result in some hearing loss. Earplugs or protectors to the ear canals or over the ears must be worn when operating this amplification system in order to prevent a permanent hearing loss, if exposure is in excess of the limits as set forth above. To ensure against potentially dangerous exposure to high sound pressure levels, it is recommended that all persons exposed to equipment capable of producing high sound pressure levels such as this amplification system be protected by hearing protectors while this unit is in operation.
20. Symbols & nomenclature used on the product and in the product manuals, intended to alert the operator to areas where extra caution may be necessary, are as follows:

| Duration Per Day in Hours | Sound Level dBA, slow response |
|---------------------------|--------------------------------|
| 8 | 90 |
| 6 | 92 |
| 4 | 95 |
| 3 | 97 |
| 2 | 100 |
| 1 1/2 | 102 |
| 1 | 105 |
| 1/2 | 110 |
| 1/4 ou inférieur | 115 |



Intended to alert the user to the presence of high 'Dangerous Voltage' within the products enclosure that may be sufficient to constitute a risk of electrical shock to persons.

Intended to alert the user of the presence of important operating and maintenance (Servicing) instructions in the literature accompanying the product.

Risk of electrical shock - DO NOT OPEN. To reduce the risk of electrical shock, do not remove the cover. No user serviceable parts inside. Refer servicing to qualified personnel.

To prevent electrical shock or fire hazard, do not expose this appliance to rain or moisture. Before using this appliance please read the operating instructions.

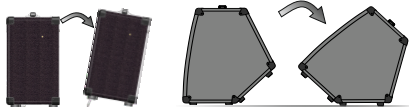

If your appliance features a tilting mechanism or a kickback style cabinet, please use this design feature with caution. Due to the ease with which the amplifier can be moved between straight and tilted back positions, only use the amplifier on a level, stable surface. DO NOT operate the amplifier on a desk, table, shelf or otherwise unsuitable non-stable platform.

INSTRUCCIONES IMPORTANTES DE SEGURIDAD



CUIDADO: Cuando use productos electrónicos, debe tomar precauciones básicas, incluyendo las siguientes:

1. Lea estas instrucciones.
2. Guarde estas instrucciones.
3. Haga caso de todos los consejos.
4. Siga todas las instrucciones.
5. No usar este aparato cerca del agua.
6. Limpiar solamente con un trapo seco.
7. No bloquear ninguna de las salidas de ventilación. Instalar de acuerdo a las instrucciones del fabricante.
8. No instalar cerca de ninguna fuente de calor como radiadores, estufas, hornos u otros aparatos (incluyendo amplificadores) que produzcan calor.
9. Un aparato con la construcción de clase I deberá conectarse a una toma de corriente que disponga una conexión con protección. No retire la patilla protectora del enchufe polarizado o con conexión a tierra. Un enchufe polarizado tiene dos clavijas, una más ancha que la otra. Un enchufe con toma de tierra tiene dos clavijas y un tercer diente de tierra. La clavija ancha (la tercera) se proporciona para su seguridad. Si el enchufe proporcionado no encaja en su toma de red, consulte a un electricista para que se reemplace por la obsoleta.
10. Proteja el cable de alimentación para que no sea pisado o pinchado, particularmente en los enchufes, hábitáculos y el punto de salida del aparato.
11. Usar solamente componentes y accesorios proporcionados por el fabricante.
12. Usar solamente un carro, pie, trípode, o soporte especificado por el fabricante, o vendido junto al aparato. Cuando se use un carro, tenga cuidado al mover el conjunto carro/aparato para evitar que se dañe en un vuelco.
13. El cable de alimentación o conector del aparato se usa como dispositivo de desconexión y debe permanecer accesible. El usuario debe permitir un acceso fácil a cualquier entrada principal, interruptor haciéndolo así más operativo. Desenchufe este aparato durante tormentas eléctricas o cuando no se use en largos períodos de tiempo.
14. Para cualquier reparación, acuda a personal de servicio cualificado. Se requieren reparaciones cuando el aparato ha sido dañado de alguna manera, como cuando el cable de alimentación o el enchufe se han dañado, algún líquido ha sido derramado o algún objeto ha caído dentro del aparato, el aparato ha sido expuesto a la lluvia o la humedad, no funciona de manera normal, o ha sufrido una caída.
15. Nunca retire la patilla de Tierra. Conecte el aparato sólo a una fuente de alimentación del tipo marcado al lado del cable de alimentación.
16. Si este producto va a ser instalado en una unidad de rack, use algún tipo de apoyo trasero.
17. Nota para el Reino Unido solamente: Si los colores de los cables en el enchufe principal de esta unidad no corresponden con los terminales en su enchufe, proceda de la siguiente manera:
 - a) El cable de color verde y azul debe ser conectado al terminal que está marcado con la letra E, el símbolo de Tierra (earth), coloreado en verde o en verde y amarillo.
 - b) El cable coloreado en azul debe ser conectado al terminal que está marcado con la letra N o el color negro.
 - c) El cable coloreado en marrón debe ser conectado al terminal que está marcado con la letra L o el color rojo.
18. Este aparato eléctrico no debe ser sometido a ningún tipo de goteo o salpicadura y se debe tener cuidado para no poner objetos que contengan líquidos, como vasos, sobre el aparato.
19. La exposición a altos niveles de ruido puede causar una pérdida permanente en la audición. La susceptibilidad a la pérdida de audición provocada por el ruido varía según la persona, pero casi todo el mundo perderá algo de audición si se expone a un nivel de ruido suficientemente intenso durante un tiempo determinado. El Departamento para la Salud y para la Seguridad del Gobierno de los Estados Unidos (OSHA) ha especificado las siguientes exposiciones al ruido permisibles:
De acuerdo al OSHA, cualquier exposición que exceda los límites arriba indicados puede producir algún tipo de pérdida en la audición. Protectores para los canales auditivos o tapones para los oídos deben ser usados cuando se opere con este sistema de sonido para prevenir una pérdida permanente en la audición, si la exposición excede los límites indicados más arriba. Para protegerse de una exposición a altos niveles de sonido potencialmente peligrosa, se recomienda que todas las personas expuestas a equipamiento capaz de producir altos niveles de presión sonora, tales como este sistema de amplificación, se encuentren protegidas por protectores auditivos mientras esta unidad esté operando.
20. Símbolos y nomenclatura utilizada en el producto y en los manuales de producto, destinado a alertar al usuario de las áreas donde la precaución adicional pueden ser necesarias, son las siguientes:

| Duración por Día en Horas | Nivel de Sonido dBA, Respuesta Lenta |
|---------------------------|--------------------------------------|
| 8 | 90 |
| 6 | 92 |
| 4 | 95 |
| 3 | 97 |
| 2 | 100 |
| 1 1/2 | 102 |
| 1 | 105 |
| 1/2 | 110 |
| 1/4 o inferior | 115 |



La intención de alertar al usuario de la presencia de "tensión peligrosa" alto dentro del recinto los productos puede ser suficiente para constituir un riesgo de descarga eléctrica para las personas.

La intención de alertar al usuario de la presencia de importantes de operación y mantenimiento (servicio) en la literatura que acompaña al producto.

Riesgo de choque eléctrico - NO ABRIR. Para reducir el riesgo de descarga eléctrica, no retire la cubierta. No hay piezas que el usuario pueda reparar. Solicite la revisión al personal cualificado.

Para evitar descargas eléctricas o incendios, no exponga este aparato a la lluvia ni a la humedad. Antes de usar este aparato, por favor lea las instrucciones de funcionamiento.

Si el aparato cuenta con un mecanismo de inclinación o un gabinete estilo de contragolpe, por favor use esta característica con precaución. Debido a la facilidad con que puede ser que el amplificador se mueva entre las posiciones recta e inclinada, utilice sólo el amplificador sobre una superficie nivelada y estable. NO haga funcionar el amplificador en un escritorio, mesa, estantería o plataforma no estable o no apta.

ATTENTION: L'utilisation de tout appareil électrique doit être soumise aux précautions d'usage incluant:

1. Lisez ces instructions
2. Gardez ce manuel pour de futures références.
3. Prêtez attention aux messages de précautions de ce manuel.
4. Suivez ces instructions.
5. N'utilisez pas cet appareil à proximité de plans d'eau.
6. N'utilisez qu'un tissu sec pour le nettoyage de votre appareil.
7. N'obstruez pas les systèmes de refroidissement de votre appareil et installez votre appareil en fonction des instructions de ce manuel.
8. Ne positionnez pas votre appareil à proximité de toute source de chaleur.
9. Un appareil avec la construction de la classe I sera relié à une prise munie d'une liaison à la terre. Branchez toujours votre appareil sur une alimentation munie de prise de terre utilisant le cordon d'alimentation fourni.
10. Protégez les connecteurs de votre appareil et positionnez les câblages pour éviter toutes déconnexions accidentelles.
11. N'utilisez que des fixations approuvées par le fabricant.
12. Lors de l'utilisation sur pied ou perche de support, assurez dans le cas de déplacement de l'ensemble enceinte/support de prévenir tout basculement intempestif de celui-ci.
13. La fiche secteur est utilisée pour couper l'alimentation de l'appareil et doit rester facilement accessible. Débranchez cet appareil pendant les orages ou s'il est inutilisé pendant de longues périodes.
14. Seul un technicien agréé par le fabricant est à même de réparer/contrôler votre appareil. Celui-ci doit être contrôlé s'il a subi des dommages de manipulation, d'utilisation ou de stockage (humidité, ...).
15. Ne déconnectez jamais la prise de terre de votre appareil.
16. Si votre appareil est destiné à être monté en rack, des supports arrière doivent être utilisés.
17. Note pour le Royaume-Uni : Si les couleurs des fils du câble d'alimentation ne correspondent pas aux fiches de la prise secteur, procédez comme suit:
 - a) Le fil vert et jaune doit être branché sur la borne repérée par la lettre E, ou le symbole de terre, ou par les couleurs vert ou verte et jaune.
 - b) Le fil bleu doit être branché sur la borne repérée par la lettre N, ou par la couleur noire.
 - c) Le fil marron doit être branché sur la borne repérée par la lettre L, ou par la couleur rouge.
18. Cet équipement électrique ne doit en aucun cas être en contact avec un quelconque liquide et aucun objet contenant un liquide, tels qu'un vase ou autre récipient.
19. Une exposition à de hauts niveaux sonores peut entraîner des dommages irréversibles de l'audition. La sensibilité au bruit varie considérablement d'un individu à l'autre, mais la majorité de la population ressentira une perte d'audition après une exposition à une forte puissance sonore pendant une durée prolongée. L'organisme de la santé américaine (OSHA) a produit le guide ci-dessous en rapport à l'exposition autorisée aux niveaux de bruit : D'après les études menées par l'OSHA, toute exposition au-delà des limites décrites ci-dessous entraînera des pertes de audition chez la plupart des sujets. Le port de système de protection (casque, oreillette de filtrage, etc...) doit être observé lors de l'utilisation de cet appareil sans quoi des dommages irréversibles peuvent être occasionnés. Le port de ces systèmes doit être observé par toutes personnes susceptibles d'être exposées à des conditions au-delà des limites décrites ci-dessous.
20. Symboles utilisés sur les produits et dans les manuels des produits, destinés à alerter l'opérateur des zones ou des précautions supplémentaires pouvant être nécessaires :

| Durée par Jour (heures) | Niveau sonore moyen (dBA) |
|-------------------------|---------------------------|
| 8 | 90 |
| 6 | 92 |
| 4 | 95 |
| 3 | 97 |
| 2 | 100 |
| 1 ½ | 102 |
| 1 | 105 |
| ½ | 110 |
| ¼ ou inférieur | 115 |



Ce symbole est utilisé pour prévenir l'utilisateur de la présence d'une tension non isolée dangereuse à l'intérieur du boîtier de l'appareil, et pouvant être suffisante pour constituer un risque de choc électrique.

Ce symbole est utilisé pour prévenir l'utilisateur de la présence d'instructions d'utilisation et de maintenance dans le mode d'emploi accompagnant l'appareil.

Risque de choc électrique – NE PAS OUVRIR Afin de réduire les risques de choc électrique, ne pas ouvrir le capot. Il n'y a aucune pièce à l'intérieur pouvant être réparée par l'utilisateur. Veuillez confier la maintenance à un personnel qualifié.

Afin de prévenir tout risque de choc électrique et d'incendie, n'exposez pas cet appareil à la pluie ou à l'humidité. Avant d'utiliser cet appareil, lisez attentivement les instructions d'utilisation de ce mode d'emploi.

Si votre appareil est équipé d'un mécanisme de basculement ou si son boîtier est conçu comme retour, veuillez utiliser cette caractéristique avec prudence. En raison de la facilité avec laquelle l'amplificateur peut être basculé entre les positions droite et inclinée, utilisez uniquement l'amplificateur sur une surface plane et stable. NE PAS faire fonctionner l'amplificateur sur un bureau, une table, une étagère ou autre plate-forme inappropriée.

重要安全说明



警告：使用电器产品时，应始终遵循基本的注意事项，包括以下各项：

1. 阅读这些说明。
2. 确保此类说明放置于安全处。
3. 注意所有警告。
4. 请遵守所有说明。
5. 请勿在近水处使用该电器。
6. 仅可用干布清洁该电器。
7. 请勿堵塞该电器上的任何通风口。根据制造商的说明进行安装。
8. 请勿将该电器安装在靠近热源，如散热器、热风机、炉子或其他发热设备（包括功率放大器）。
9. 与 I 类建筑设备连接时，应连接到带保护的电源插座上。不要忽视极性或接地类型插头的安全作用。极性插头具有两个片状电极，其中一个较宽。接地类型插头具有两个片状电极和第三只接地脚。宽片状电极或第三只接地电极用于保证使用者及电器的安全。如所提供的插头不适用于插座，须请专业人员更换，切勿自行更换电源插座。
10. 保护电源线，不被踩踏或挤压，尤其在插头、插座以及电源线的连接处。
11. 仅可采用制造商提供的附件或配件。
12. 仅可使用制造商指定的、或与该电器一同出售的货车、台架、三脚架、支架或台桌。使用货车，及移动货车/搬运该电器时，须注意，避免倾翻产生损坏。
13. 电源插头或该电器的转接插头，应保持其易操作性。用户应使用该电器匹配的电源插头、连接器和电源开关，应易于操作。在雷雨或长时间不使用时，拔下该电源插头。
14. 当该电器受到任何方式的损坏时，如：电源线或插头被损坏、液体泼溅或物体落入电器内、该电器放置于有雨水或潮湿处、及该电器坠落后，无法正常运行，需进行检修时，必须请有资格认证的维修人员进行维修。
15. 请勿折断电源插头上的接地极。仅可连接到在插头的片状电极旁边已标注符号的极性上。

| 每天持续时间 (小时) | 噪声程度 (dBA) 限值范围 |
|----------------|--------------------|
| 8 | 90 |
| 6 | 92 |
| 4 | 95 |
| 3 | 97 |
| 2 | 100 |
| 1 1/2 | 102 |
| 1 | 105 |
| 1/2 | 110 |
| 1/4 或更少 | 115 |

16. 如此电器须安装在设备架上，应提供后部支架。
17. 仅适用于英国的注意事项。如该电器的电源线中电缆颜色与插头片状电极不相符，请按照以下步骤进行操作：
 - a) 黄绿色电缆须连接至标有字母“E”的电极，为接地符号。颜色为黄绿色或绿色。
 - b) 蓝色电缆须连接至标有字母“N”的电极，颜色为蓝色或黑色。
 - c) 棕色电缆须连接至标有字母“L”的电极，颜色为棕色或红色。
18. 该电器不能放置于有水滴或有水溅出的地方，须注意，不要将盛有液体的容器，如花瓶放在该电器上。
19. 如果人处于极高噪音级中可能会造成永久失聪。每个人受噪音导致听力损害的差异很大。然而若长时间处于极强噪音中，任何人几乎都会造成不同程度的听力损害。美国政府职业安全健康管理局（OSHA）指定了以下允许范围内的噪音级别，见右表：根据 OSHA，任何超出上述允许的极限范围可导致不同程度的听力损害。在运行该电器时，人体处于超出了以上设定的限制，须佩戴耳塞或配备耳朵的保护装置，以防永久性听力损害。为避免可能处于强声压程度的危险，该电器运行时，建议处于强声压程度下的所有人都配备听力保护装置。
20. 用于产品和说明书上的符号和术语是为了提醒操作人员注意需要额外注意的地方，具体如下：

旨在提醒使用者小心产品空箱内的未绝缘“危险电压”，这可能足以对人构成触电危险。



旨在提醒使用者与产品一起提供的说明书中的重要操作和维护（保修）说明。小心触电-不能打开

为了降低触电风险，请不要打开盖子。里面不含任何用户可用的配件。请将维修交于被许可的人员。

为避免触电或火灾，请不要将本产品置于雨中或潮湿环境中。在使用本产品前，请仔细阅读操作说明。



21. 该产品仅适用于海拔2000m以下地区安全使用



该产品仅适用于非热带气候条件下安全使用

如果你的产品是倾斜的结构或是后倾款式的箱体，请小心使用该设计特征。由于功放可以在直立和后倾方式之间转换，请在平坦、牢固的表面使用该产品。请不要在桌子、架子或其它不适合、不牢固的平台上使用该功放。

安全上の重要な注意事項



電子機器を使用する際は、下記の注意事項に従ってご使用ください。

ご使用前には必ずこの説明書をお読みください。

説明書は大切に保管してください。

すべての注意事項を確認してください。

水などの液体を本体にこぼしたり、内部にかからないように注意してください。

掃除するときは、乾いた布のみを使用してください。

通気孔は絶対に塞がないでください。

ラジエーター、ヒートレジスター、ストーブ等、熱を発生する装置（アンプを含む）

の近くには決して置かないでください。

電源コードは、踏まれたりはさまれたりしないように注意してください。

メーカーによって供給されたパーツ以外は使用しないでください。

キャスター等は、付属品を使用してください。転倒等の事故がないように十分注意してください。

長時間使用しない時、また雷雨の時などはコンセントを抜いてください。

電源コードやプラグの破損、強い衝撃や、液濡れ等の理由で正常に装置が動作しない場合は、

ご購入店にご相談ください。

激しい騒音環境下では、永続的な難聴を引き起こす可能性があります。

騒音性 難聴への影響度には個人差がありますが、

激しい騒音の中にある一定の期間さらされた場合、

ほとんどの人の聴覚に悪影響を及ぼす可能性があります。米国政府の

労働安全衛生局（OSHA）は、ノイズレベルの許容量（条件）

を定めています： OSHAによると、許容量を超える騒音は、

少なからず難聴に繋がる可能性があります。 このアンプシステムを操作する際、

万が一制限値を超えている場合は、永続的な 難聴を防ぐためにも耳栓などを使用してください。

機材またはマニュアルに記載された記号、及び名称は、ご使用時に注意が必要なものとなります。

下記をご参照ください。

| 1日の時間数 | 騒音レベル(dBA) 応答が速い |
|----------|---------------------|
| 8 | 90 |
| 6 | 92 |
| 4 | 95 |
| 3 | 97 |
| 2 | 100 |
| 1 1/2 | 102 |
| 1 | 105 |
| 1/2 | 110 |
| 1/4 それ以下 | 115 |



機材内部には、人に感電する危険性のある“高電圧”が流れている場合があります。

付属の冊子に書かれている操作上、または管理上（サービス上）重要な事項を確認してください。

製品カバーを開けないでください。感電の危険性を減らすためにも、蓋は取り外さないでください。

内部にはユーザーが修理できる部品はありません。資格ある技術者の指示を仰いでください。

感電や火災の危険を防止するため、この装置を雨や湿気にさらさないでください。使用する前には、必ず取扱説明書をお読みください。

（アンプを使用しないときは、スイッチをオフにし、電源コードは抜いてください）

場合は、アプライアンスの機能傾斜機構やキックバック スタイルのキャビネットは、注意してこのデザイン機能を使用してください。

アンプ ストレートと戻って傾斜の位置間で移動できますがしやすさのため、

水平で安定した表面に、アンプのみ使用します。

デスク、テーブル、

棚またはそれ以外の場合に不適切な

nonstable **プラットフォーム上増幅器を**

操作しないでください。

중요안전수칙

경고: 전기 제품을 사용하는 경우, 다음과 같은 기본적인 수칙을 항상 준수해야 합니다.

1. 지침을 읽으십시오.
 2. 지침을 안전하게 보관하십시오.
 3. 모든 경고에 유의하십시오.
 4. 모든 지침을 따르십시오.
 5. 이 제품을 물 근처에서 사용하지 마십시오.
 6. 항상 마른 천으로 청소하십시오.
 7. 통풍구를 막지 마십시오. 제조사의 지침에 따라 설치하십시오.
 8. 난방기, 열 조절 장치, 스토브 또는 다른 장치(엠프 포함) 등 발열 근처에 설치하지 마십시오.
 9. Class I 구조의 제품은 보호 커넥션과 함께 전원 콘센트에 연결해야 합니다. 유극 형 또는 접지 형 플러그의 안전수칙을 준수하십시오. 유극형 플러그는 다른 것보다 넓은 두 개의 날이 있습니다. 접지 형 플러그에는 두 개의 날과 세 번째 접지가닥이 있습니다. 넓은 날이나 세 번째 접지용 가닥은 사용자의 안전을 위해 제공됩니다. 제공된 플러그가 사용자의 콘센트와 맞지 않는 경우에는 전기 기술자에게 콘센트 교체를 문의하십시오.
 10. 특히 플러그, 콘센트 및 기기에서 나오는 곳에서 전원모드가 발히거나 고이는 것을 방지하십시오.
 11. 제조사가 제공하는 부속 및 액세서리만을 사용하십시오.
 12. 제조사가 지정한 카드, 스탠드, 삼각대, 받침대 또는 테이블 그리고 제품과 함께 판매된 것들만 사용하십시오. 카드를 제품과 함께 이동할 때 제품이 뒤집어져 부상을 당하지 않도록 카드 사용시 주의하십시오.
 13. 전원 플러그나 기기용 커블러는 분리장치로 사용되며 즉시 작동할 수 있는 상태로 유지해야 합니다. 사용자는 모든 전원 플러그에 쉽게 접근이 가능해야 하며 전원 커블러와 전원 스위치가 이 유닛과 잘 결합하여 쉽게 작동해야 합니다. 천동번개나 장시간 사용하지 않을 경우 장기의 플러그를 뽑으십시오.
 14. 자격을 갖춘 서비스 엔지니어에게 모든 서비스를 문의하십시오. 예를 들어 전원 공급 코드나 플러그가 손상되었거나 액체가 제품에 떨어진 경우, 제품을 비 또는 습기에 노출된 경우, 정상적으로 작동하지 않거나 제품을 떨어뜨린 경우에는 서비스가 필요합니다.
 15. 그라운드 핀을 억지로 분리하지 마십시오. 전원코드에 인접한 장치에 표시된 유형의 전원에만 연결하십시오.
 16. 이 제품을 장비선반에 올릴 경우 뒷면 지지대가 필요합니다.
 - a) 녹색과 노랑색 사이에는 E라고 적힌 녹색이나 노랑색 테이널과 연결되어야 합니다.
 - b) 파란색 사이에는 N이라고 적힌 검은색 테이널과 연결되어야 합니다.
 - c) 갈색 사이에는 L이라고 적힌 빨간색 테이널과 연결되어야 합니다.
 17. 이 전기 제품은 습기나 액체에 노출되지 않아야 하며, 액체를 포함하는 꽃병과 함께 위치하면 안 됩니다.
 18. 상당히 높은 노이즈 레벨에 노출되면 청력이 손상될 수 있습니다. 상당한 시간 동안 집중적인 노이즈에 노출되면 거의 모든 사람들이 청력을 상실할 수 있습니다.
- 미국 정부의 산업안전보건관리 Occupational Safety and Health Administration (OSHA)는 다음과 같은 허용 소음 레벨을 지정하였습니다. OSHA에 따르면 위의 허용 한도를 초과하는 노출은 약간의 청력 손실이 발생할 수 있습니다. 이 엠프 시스템을 작동할 때 노출이 위 명시된 한계를 초과하는 경우, 영구적인 청력 손실을 방지하기 위해서 귀를 보호하기 위한 귀마개 등을 착용해야 합니다. 또한 높은 음압의 잠재적인 위험 노출에 대비하기 위해서는 엠프 같은 높은 음압을 낼 수 있는 기기가 작동되는 동안 귀 보호장치가 필요합니다.
20. 사용자의 주의가 필요한 제품 매뉴얼에서 사용되는 기호 및 명칭은 다음과 같습니다.

| 하루 평균시간 | Sound Level dBA, slow response |
|---------|--------------------------------|
| 8 | 90 |
| 6 | 92 |
| 4 | 95 |
| 3 | 97 |
| 2 | 100 |
| 1 1/2 | 102 |
| 1 | 105 |
| 1/2 | 110 |
| 1/4 | 115 |



제품에 동봉된 'Dangerous Voltage'는 사람에게 전기적 충격의 위험을 경고하기 위한 것입니다.

제품에 주요 동작 및 유지 보수(서비스) 내용이 포함된 지침서는 사용자를 위한 것입니다.

감전위험- 멀리하십시오. 감전의 위험을 줄이기 위해 커버를 제거하지 마십시오. 자격을 갖춘 엔지니어에게 문의하십시오.

감전이나 화재의 위험을 방지하기 위해서 이 제품을 비나 습기에 노출시키지 마십시오. 이 제품을 사용하기 전에 사용설명서를 읽어보시기 바랍니다.

(엠프를 사용하지 않을 때는 항상 스위치를 끄고 전원 코드를 뽑으십시오.)

사용자의 기기가 리벳 스타일(기기를 뒤로 기울이는 스타일)의 캐비닛인 경우 이 디자인의 주의사항을 확인하십시오. 편의 때문에 엠프를 똑바로 세우거나 기울이면 엠프를 평평한 곳에서 사용하십시오. 엠프를 절대 책상이나 테이블 선반 또는 다른 적합하지 않은 곳에서 작동하지 마십시오.

AVISO: Ao usar produtos elétricos, adverte básica devem ser sempre seguidas, incluindo as seguintes:

1. Leia estas instruções.
2. Guarde estas instruções de segurança.
3. Preste atenção a todos os avisos.
4. Siga todas as instruções.
5. Não use este aparelho perto da água.
6. Limpe apenas com um pano seco.
7. Não bloqueie qualquer uma das aberturas de ventilação. Instale de acordo com as instruções do fabricante.
8. Não instale perto de fontes de calor, como radiadores, aquecedores, fogões ou outros aparelhos (incluindo amplificadores) que produzem calor.
9. Um aparelho com a construção de classe I devem ser conectado a uma tomada elétrica com ligação de proteção. Não anule a finalidade de segurança da ficha polarizada ou do tipo terra. Uma ficha polarizada possui duas lâminas, uma mais larga que a outra. Uma ficha do tipo terra tem duas lâminas e um terceiro pino de aterramento. A lâmina larga ou o terceiro pino são fornecidos para sua segurança. Se a ficha fornecida não encaixar na sua tomada, consulte um electricista para a substituição da tomada obsoleta.
10. Proteja o cabo de alimentação de pisadelas ou apertos, especialmente nas fichas, receptáculos de conveniência e no ponto de saída do aparelho.
11. Utilize apenas ligações / acessórios fornecidos pelo fabricante.
12. Use somente com o carrinho, estrutura, tripé, suporte, ou mesa especificados pelo fabricante ou vendidos com o aparelho. Quando utilizar um carrinho, tenha cuidado ao mover o conjunto carrinho / dispositivo para evitar danos provocados pela queda. 13. A ficha da tomada ou aparelho forem utilizados como dispositivo de desconexão e deve estar sempre acessível. O usuário deve permitir o acesso fácil a qualquer ficha, acoplador de alimentação e interruptor de rede usada em conjunto com esta unidade, assim, tornando-o acessível. Desligue o aparelho durante tempestades com raios ou quando não for utilizado por longos períodos de tempo.
14. Solicite a assistência de pessoal qualificado. A manutenção é necessária quando o aparelho tiver sido danificado de qualquer maneira, como quando o cabo de alimentação ou a ficha estiverem danificados, líquido foi derramado ou objetos caídos dentro do aparelho, o aparelho tenha sido exposto à chuva ou umidade, não operar normalmente, ou se tiver caído.
15. Nunca quebre o pino terra. Ligue apenas a uma fonte de energia do tipo marcadas na unidade adjacente ao cabo de fornecimento de energia.
16. Se este produto for para ser montado em um bastidor de equipamentos, o suporte traseiro deve ser fornecido. 17. Nota para o Reino Unido: Se as cores dos fios do cabo de alimentação da unidade não correspondem com os terminais na ficha, faça o seguinte:
 - a) O fio que é colorido verde e amarelo tem de ser ligado ao terminal que está marcada com a letra E, o símbolo de terra, de cor verde ou colorido em verde e amarelo.
 - b) O fio é de cor azul, que tem de ser ligado ao terminal que está marcada com a letra N ou a cor preta.
 - c) O fio que é castanho deve ser ligado ao terminal que está marcada com a letra L ou a cor vermelha. Aparelhos elétricos.
18. This não deve ser exposto a respingos e os cuidados devem ser tomados para não colocar objetos que contenham líquidos, tais como vasos, sobre o aparelho.
19. A exposição a níveis de ruído extremamente alta pode causar uma perda permanente da audição. Os indivíduos variam consideravelmente a susceptibilidade ao ruído induzido perda de audição, mas quase todo mundo vai perder alguma audição se expostos a ruído suficientemente intensa durante um tempo suficiente.

Segurança do Trabalho do governo dos EUA e Administração de Saúde (OSHA) especificou os seguintes exposições de nível de ruído admissíveis: de acordo com OSHA, a exposição em excesso dos limites admissíveis acima poderia resultar em alguma perda de audição. Tampões ou protetores para o canal auditivo ou sobre as orelhas, deve ser usada quando se opera este sistema de amplificação de modo a evitar a perda permanente da audição, se a exposição for superior a dos limites tal como descrito acima. Para garantir contra a exposição potencialmente perigoso para elevados níveis de pressão de som, recomenda-se que todas as pessoas expostas a um equipamento capaz de produzir níveis elevados de pressão sonora, como este sistema de amplificação de ser protegidos por protetores auditivos enquanto esta unidade está em operação.
20. Símbolos e nomenclatura utilizados no produto e nos manuais de produtos, destinados para alertar o operador para as áreas onde o cuidado extra pode ser necessário, são os seguintes:

| duración por Día em Horas | DBA Nivel de som, resposta lenta |
|---------------------------|----------------------------------|
| 8 | 90 |
| 6 | 92 |
| 4 | 95 |
| 3 | 97 |
| 2 | 100 |
| 1 1/2 | 102 |
| 1 | 105 |
| 1/2 | 110 |
| 1/4 or less | 115 |



Com a intenção de alertar o utilizador para a presença de "tensão perigosa" alto dentro do recinto produtos que poderá ser suficiente para constituir um risco de choque elétrico para as pessoas.



Com a intenção de alertar o usuário da presença de importantes de operação e manutenção (assistência) na literatura que acompanha o produto.

Risco de choque elétrico - NÃO ABRA. Para reduzir o risco de choque elétrico, não remover a tampa. Não existem peças no interior. Consulte um técnico qualificado.

Para evitar choque elétrico ou risco de incêndio, não exponha este aparelho à chuva ou umidade. Antes de utilizar este aparelho, leia atentamente as instruções de operação.

Se o seu aparelho possui um mecanismo de inclinação ou um armário estilo propina, por favor, use esse recurso de design com cautela. Devido à facilidade com que o amplificador pode ser movida entre as posições de costas rectas e inclinada, usar apenas o amplificador numa superfície plana é estável. NÃO operar o amplificador em uma escrivaninha, mesa, prateleira ou de alguma forma inadequada plataforma nonstable.

ACHTUNG: Beim Einsatz von Elektrogeräten müssen u.a. grundlegende Vorsichtsmaßnahmen befolgt werden:

1. Lesen Sie sich diese Anweisungen durch.
2. Bewahren Sie diese Anweisungen auf.
3. Beachten Sie alle Warnungen.
4. Befolgen Sie alle Anweisungen.
5. Setzen Sie dieses Gerät nicht in der Nähe von Wasser ein.
6. Reinigen Sie es nur mit einem trockenen Tuch.
7. Blockieren Sie keine der Lüftungsöffnungen. Führen Sie die Installation gemäß den Anweisungen des Herstellers durch.
8. Betreiben Sie das Gerät nicht neben Wärmequellen wie Heizungen, Heizgeräten, Öfen oder anderen Geräten (auch Verstärkern), die Wärme erzeugen.
9. Verwenden Sie nur Kaltgeräte-Netzkabel aus dem Fachhandel.
10. Schützen Sie das Netzkabel, sodass niemand darauf tritt oder es geknickt wird, insbesondere an Steckern oder Buchsen am Gerät.
11. Verwenden Sie nur die vom Hersteller erhältlichen Zubehörgeräte oder Zubehörteile.
12. Verwenden Sie nur einen Wagen, Stativ, Dreifuß, Träger oder Tisch, der den Angaben des Herstellers entspricht oder zusammen mit dem Gerät verkauft wurde. Wird ein Wagen verwendet, bewegen Sie den Wagen mit dem darauf befindlichen Gerät besonders vorsichtig, damit es nicht umkippt und möglicherweise jemand verletzt wird.
13. Der Netzstecker bzw. Gerätestecker wird zum Trennen vom Stromnetz verwendet und muß immer leicht zugänglich sein.

| Dauer pro Tag in Stunden | Geräuschpegel dBA langsame Reaktion |
|--------------------------|-------------------------------------|
| 8 | 90 |
| 6 | 92 |
| 4 | 95 |
| 3 | 97 |
| 2 | 100 |
| 1 ½ | 102 |
| 1 | 105 |
| ½ | 110 |
| ¼ oder weniger | 115 |

- der Benutzer sollte auf einfachen Zugang zu allen Netzsteckern, Gerätesteckern und Netz-Schaltern achten
Ziehen Sie den Netzstecker bei Gewitter heraus oder wenn das Gerät längere Zeit nicht benutzt wird.
14. Lassen Sie sämtliche Wartungsarbeiten von qualifizierten Kundendiensttechnikern durchführen. Eine Wartung ist erforderlich, wenn das Gerät in irgendeiner Art beschädigt wurde, etwa wenn das Netzkabel oder der Netzstecker beschädigt wurden, Flüssigkeit oder Gegenstände in das Gerät gelangt sind, das Gerät Regen oder Feuchtigkeit ausgesetzt wurde, nicht normal arbeitet oder heruntergefallen ist.
 15. Schließen Sie das Gerät nur an eine Stromquelle an, die am Gerät neben dem Netzkabel angegeben ist.
 16. Wenn dieses Produkt in ein Geräte-Rack eingebaut werden soll, muss eine Versorgung über die Rückseite eingerichtet werden.
 18. Dieses Gerät darf nicht ungeschützt Wassertropfen und Wasserspritzern ausgesetzt werden und es muss darauf geachtet werden, dass keine mit Flüssigkeiten gefüllte Gegenstände, wie z. B. Blumenvasen, auf dem Gerät abgestellt werden.
 19. Belastung durch extrem hohe Lärmpegel kann zu dauerhaftem Gehörverlust führen. Die Anfälligkeit für durch Lärm bedingten Gehörverlust ist von Mensch zu Mensch verschieden, das Gehör wird jedoch bei jedem in gewissem Maße geschädigt, der über einen bestimmten Zeitraum ausreichend starkem Lärm ausgesetzt ist. Die US-Arbeitsschutzbehörde (Occupational and Health Administration, OSHA) hat die folgenden zulässigen Pegel für Lärmbelastung festgelegt:
Laut OSHA kann jede Belastung über den obenstehenden zulässigen Grenzwerten zu einem gewissen Gehörverlust führen. Sollte die Belastung die obenstehenden Grenzwerte übersteigen, müssen beim Betrieb dieses Verstärkungssystems Ohrstöpsel oder Schutzvorrichtungen im Gehörgang oder über den Ohren getragen werden, um einen dauerhaften Gehörverlust zu verhindern. Um sich vor einer möglicherweise gefährlichen Belastung durch hohe Schalldruckpegel zu schützen, wird allen Personen empfohlen, die mit Geräten arbeiten, die wie dieses Verstärkungssystem hohe Schalldruckpegel erzeugen können, beim Betrieb dieses Geräts einen Gehörschutz zu tragen.

20. Symbole und Nomenklatur, die auf dem Produkt und in den Handbüchern stehen, sollen den Bediener auf die Bereiche, in denen besondere Vorsicht notwendig sein kann, alarmieren und sind wie folgt:

Sollen den Benutzer auf das Vorhandensein von "gefährlicher Hoch-Spannung" im Gerätegehäuse hinweisen, um die Gefahr eines elektrischen Schlags für Personen zu vermeiden..



Sollen den Benutzer auf das Vorhandensein wichtiger Betriebs- und Wartungsanweisungen in der beigelegten Dokumentation aufmerksam machen.



Gefahr eines elektrischen Schlags - NICHT ÖFFNEN. Um die Gefahr eines elektrischen Schlags zu reduzieren, darf die Abdeckung entfernt werden. Keine zu wartenden Teile im Inneren. Überlassen Sie die Wartung qualifiziertem Fachpersonal.

Gefahr eines elektrischen Schlags - NICHT ÖFFNEN. Um die Gefahr eines elektrischen Schlags zu vermeiden, darf die Abdeckung nicht geöffnet werden.. Überlassen Sie die Wartung qualifiziertem Fachpersonal.

Wenn Ihr Gerät über einen Kippmechanismus oder eine "Tilt-back"- Funktion verfügt, benutzen Sie diese Funktion mit Vorsicht. Aufgrund der Leichtigkeit, mit der der Verstärker zwischen geraden und schrägen Rücken Positionen bewegt werden kann, verwenden Sie nur den Verstärker auf einer ebenen, stabilen Oberfläche. NICHT den Verstärker auf einem Schreibtisch, Tisch, Regal oder sonst eine ungeeignete nicht stabile Plattform stellen.

IMPORTANTI ISTRUZIONI DI SICUREZZA



AVVERTENZA: Quando si usano prodotti elettrici, alcune precauzioni dovrebbero essere sempre seguite, tra cui le seguenti:

1. Leggere queste istruzioni.
 2. Conservare queste istruzioni di sicurezza.
 3. Osservare tutte le avvertenze.
 4. Seguire tutte le istruzioni.
 5. Non utilizzare questo apparecchio vicino all'acqua.
 6. Pulire solo con un panno asciutto.
 7. Non ostruire le aperture di ventilazione. Installare in conformità con le istruzioni del produttore.
 8. Non installare vicino a fonti di calore come radiatori, regolatori di calore, stufe o altri apparecchi (inclusi gli amplificatori) che producono calore.
 9. Un apparecchio in Classe I deve essere collegato a una presa di corrente di rete con connessione di protezione. Non annullare l'obiettivo di sicurezza della spina polarizzata o con messa a terra. Una spina polarizzata ha due lame, una più larga dell'altra. Una spina con messa a terra ha due lame e un terzo polo di terra. La lama più larga o il terzo polo servono per la sicurezza. Se la spina fornita non è adatta alla propria presa, consultare un elettricista per la sostituzione della presa obsoleta.
 10. Proteggere il cavo di alimentazione venga calpestate o schiacciato, soprattutto in corrispondenza delle spine, delle prese e al punto in cui esse dall'apparecchio.
 11. Usare solo dispositivi opzionali / accessori forniti dal produttore.
 12. Usare solo con un carrello, supporto, cavalletto, sostegno o tavola specificate dal produttore o venduti con l'apparecchio. Quando si usa un carrello, prestare attenzione, muovendo il carrello / la combinazione di apparecchi, a non ferirsi-over.
 13. La spina dell'alimentazione o apparecchio viene utilizzato come dispositivo di scollegamento e deve restare sempre operativo. L'utente deve consentire un facile accesso a qualsiasi presa di rete, accoppiatore di rete e interruttori di rete utilizzato in combinazione con l'unità rendendo così facilmente accessibile. Scollegare l'apparecchio durante i temporali o se non viene utilizzato per lunghi periodi di tempo.
 14. Per l'assistenza rivolgersi a personale qualificato. L'assistenza è necessaria quando l'apparecchio è stato danneggiato in qualsiasi modo, come ad esempio quando il cavo di alimentazione o la spina sono danneggiati, è stato versato del liquido o degli oggetti sono caduti all'interno, l'apparecchio è stato esposto a pioggia o umidità, non funziona normalmente, o è stato fatto cadere.
 15. Non rompere il pin di terra. Collegare ad una presa di potenza del tipo indicato sull'apparecchio adiacente al cavo di alimentazione.
 16. Se il prodotto deve essere montato in un rack, supporto posteriore dovrebbe essere fornito.
 18. This apparecchio elettrico non deve essere esposto a gocce o schizzi e si deve prestare attenzione a non posizionare oggetti contenenti liquidi, come vasi, sopra l'apparecchio.
 19. L'esposizione a livelli sonori molto elevati può causare la perdita permanente dell'udito. Gli individui La sensibilità al rumore perdita dell'udito causata, ma quasi tutti si perde un po' di danni in caso di esposizione al rumore sufficientemente intenso per un tempo sufficiente.
- Sicurezza sul lavoro del governo degli USA and Health Administration (OSHA) ha elaborato la seguente tabella di tolleranza ai rumori: Secondo l'OSHA, l'esposizione prolungata ai limiti riportati qui a fianco potrebbe causare perdita di udito. Tappi per le orecchie o protezioni per il condotto orecchie o sopra le orecchie devono essere indossati quando si adopera questo sistema di amplificazione, al fine di evitare la perdita permanente dell'udito, se si superano i limiti di cui sopra. Per assicurarsi contro un'esposizione potenzialmente pericolosa ad elevati livelli di pressione sonora, si raccomanda che tutte le persone esposte ad apparecchi in grado di produrre elevati livelli di pressione sonora, come questo sistema di amplificazione essere protetti da dispositivi di protezione dell'udito mentre l'unità è in funzione.
20. Simboli e nomenclatura utilizzati sul prodotto e nei manuali dei prodotti, finalizzate ad avvisare l'operatore di aree in cui cautela possono essere necessari, sono i seguenti:

| Duration Per Day in Hours | Sound Level dB(A, slow response) |
|---------------------------|----------------------------------|
| 8 | 90 |
| 6 | 92 |
| 4 | 95 |
| 3 | 97 |
| 2 | 100 |
| 1 1/2 | 102 |
| 1 | 105 |
| 1/2 | 110 |
| 1/4 or less | 115 |



Scopo di avvisare l'utente della presenza di 'tensioni pericolose' alta all'interno del prodotto che può essere sufficiente per costituire un rischio di scossa elettrica per le persone.

Destinato per avvisare l'utente della presenza di importanti operativi e di manutenzione (assistenza) nella documentazione che accompagna il prodotto.

Rischio di scossa elettrica - **NON APRIRE**. Per ridurre il rischio di scosse elettriche, non rimuovere il coperchio. Non ci sono parti riparabili dall'utente. Per la manutenzione rivolgersi a personale qualificato.

Per evitare scosse elettriche o incendi, non esporre questo apparecchio alla pioggia o all'umidità. Prima di utilizzare questo apparecchio leggere le istruzioni per l'uso.

(Spegnerne sempre e scollegare il cavo di alimentazione quando l'amplificatore non è in uso)

Se il vostro apparecchio è dotato di un meccanismo di inclinazione o di un mobile in stile contraccoppo, si prega di inclinare questa caratteristica di design con cautela. A causa della facilità con cui l'amplificatore può essere spostato tra le posizioni schiena dritta e inclinata, utilizzare solo l'amplificatore su una superficie piana e stabile. **NON** utilizzare l'amplificatore su una scrivania, tavolo, uno scaffale o comunque inadatti piattaforma nonstabile.



USER MANUAL

MODEL NUMBER:

SERIAL NUMBER:

PLACE OF PURCHASE:

DATE OF PURCHASE:

PLEASE COMPLETE FOR FUTURE REFERENCE

 LANEYAMPLIFICATION

 LANEYAMPLIFICATION

 LANEYAMPS

 LANEYTV

DESIGNED & ENGINEERED IN THE UK BY LANEY

WWW.LANEY.CO.UK

REVISION 1.00