

REDNET D16 AES

REDNET D16R AES

User Guide

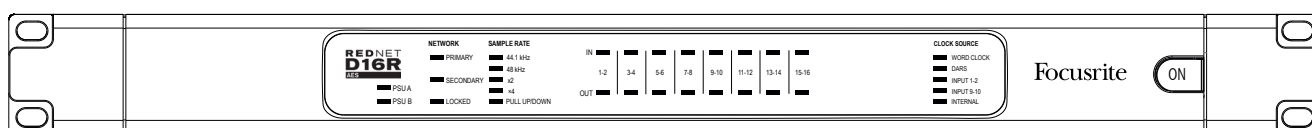
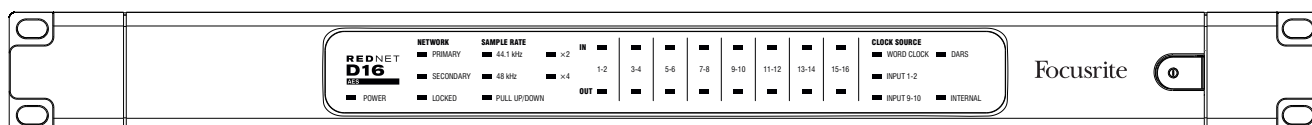

Focusrite®
www.focusrite.com

CONTENTS

About this User Guide	3
Box Contents	3
INTRODUCTION	4
INSTALLATION GUIDE	5
RedNet D16/D16R Connections and Features	5
Front Panels	5
Rear Panels	6
Power Connection	8
IEC Power Cord Retaining Clip	8
Physical Characteristics	9
Power Requirements	9
REDNET D16/D16R OPERATION	10
First Use and Firmware Updates	10
Digital Clocking	10
Pull Up and Pull Down Operation	10
Sample Rate Converters	10
OTHER REDNET SYSTEM COMPONENTS	11
USING REDNET CONTROL	11
Signal Metering	11
ID (Identification)	12
Tools Menu	12
APPENDIX	13
Connector Pinouts	13
Ethernet Connector	13
DB-25 (AES59) Connector	13
XLR Connectors	13
PERFORMANCE AND SPECIFICATIONS	14
Focusrite RedNet Warranty and Service	16
Registering Your Product	16
Customer Support and Unit Servicing	16
Troubleshooting	16

About this User Guide

This User Guide applies to both the RedNet D16 and RedNet D16R AES interfaces. It provides information about installing each unit and how either can be connected into your system.

All references relating to the RedNet D16 are also applicable to the RedNet D16R. In any instances where names or values differ, the screening or value for the D16R unit will be appended in square brackets, eg., "Power [PSU A]".

D16R

Any information that is relevant to only one device will be separated within a border like this.

A RedNet System User Guide is also available from the RedNet product pages of the Focusrite website. The Guide provides a detailed explanation of the RedNet system concept, that will help you achieve a thorough understanding of its capabilities. We recommend that all users, including those already experienced in digital audio networking, take the time to read through the System User Guide so that they are fully aware of all the possibilities that RedNet and its software have to offer.

Should either User Guide not provide the information you need, be sure to consult: www.focusrite.com/rednet, which contains a comprehensive collection of common technical support queries.

Box Contents

- RedNet D16 [D16R] unit
- 1 [2] x IEC AC mains cables
- 1 [2] x IEC mains cable retaining clips *(See instructions on page 8)*
- 2m Cat 6 Ethernet cable *D16 only*
- Safety information cut sheet
- RedNet Getting Started Guide
- Product registration card, provides links to:
 - RedNet Control
 - RedNet PCIe drivers (included with RedNet Control download)
 - Audinate Dante Controller (installed with RedNet Control)
 - Dante Virtual Soundcard (DVS) Token and download instructions

INTRODUCTION

Thank you for purchasing the Focusrite RedNet D16/D16R.



RedNet D16



RedNet D16R

RedNet D16/D16R is a 1U 19in rack-mount interface featuring 16 channels of AES/EBU connectivity to and from a Dante audio network – perfect for bridging between digital consoles, power amplifiers or any other AES3 equipped audio equipment and a Dante network.

Dual Ethernet connectors (primary and secondary) on the rear-panel allow maximum network reliability with seamless switchover to a standby network in the unlikely event of a network failure. These ports may also be used to daisy-chain additional units when operating in Switched mode.

D16R

Redundant power supplies (PSU A and B) with separate input sockets on the rear panel allow one supply to be connected to an uninterruptible source. Each PSU's status can be monitored remotely over the network or from the front panel.

RedNet D16/D16R has a Sample Rate Converter (SRC) on each input pair allowing instant operation with any AES/EBU source irrespective of the sample rate or clocking of the Dante audio network.

Audio interface is provided by two standard 8-channel (AES59) Combined Digital I/O DB25 connections. In addition, a duplicate of channels 1 & 2 is available on a pair of XLR connectors.

S/PDIF input and outputs are provided on RCA connectors; ideal for connecting CD players or solid-state recorders. The input replaces channels 3 & 4 in the DB25 connector while the output can be assigned to replicate any adjacent odd/even pair.

Word Clock I/O on BNC connectors allows synchronisation of the Dante network to house clock, or syncing external equipment to the Dante network. DARS reference can also be accepted via the XLR input connector.

The RedNet D16/D16R front panel contains a set of LEDs to confirm network status, sample rate, clock sources and signal presence on both input and output.

INSTALLATION GUIDE

RedNet D16/D16R Connections and Features

Front Panels

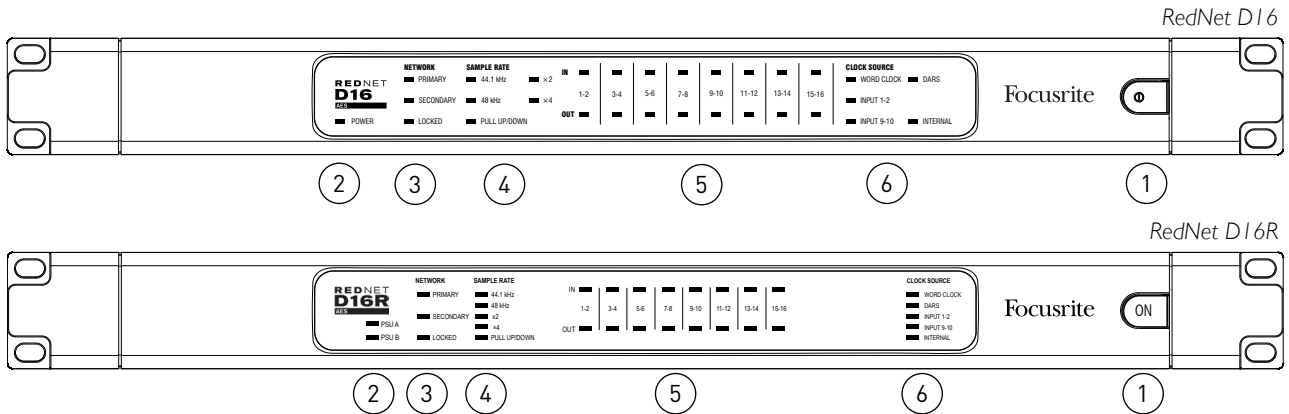

1. AC Power Switch

2. Power Indicator(s)

- **Power [PSU A]** – Illuminates when an AC input is applied and all DC outputs are present.

D16R

- **PSU B** – Illuminates when an AC input is applied and all DC outputs are present.

When both supplies are functioning and have AC inputs PSU A will be the default supply.

3. RedNet Network Status Indicators:

- **PRIMARY** – Illuminates when the device is connected to an active Ethernet network. Also illuminates to indicate network activity when operating in switched mode.
- **SECONDARY** – Illuminates when the device is connected to an active Ethernet network. Not used when operating in Switched mode.
- **LOCKED** – Illuminates when a valid sync signal is received from the network, or when the RedNet D16/D16R unit is Network Master. Flashes if external clock is selected but not connected.

4. RedNet Sample Rate Indicators

Five orange indicators: **44.1 kHz**, **48 kHz**, **x2** (multiple of 44.1 or 48), **x4** (multiple of 44.1 or 48) and sample rate **PULL UP/DOWN**. These Indicators illuminate individually or in combination to indicate the sample rate being used. For example, for a 96kHz Pull Up/Down setting, the 48kHz, x2 and Pull Up/Down indicators will illuminate.

5. Signal Presence LEDs

LEDs Indicate whether an input or an output signal is present for each odd/even channel pair. Illuminate at -126dBFS.

6. Clock source

Five orange indicators: **Word Clock**, **DARS**, **Input 1-2**, **Input 9-10** and **Internal**. Whichever is lit identifies the clock reference being used. When an incoming clock source is invalid, the 'Locked' indicator will flash to indicate that the unit has reverted to using its internal clock.

Rear Panels

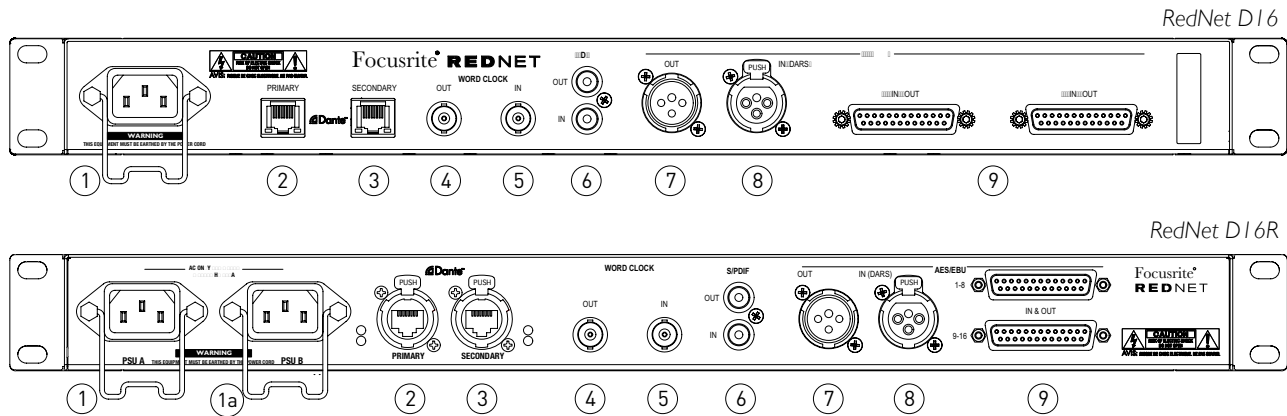

1. IEC Mains Inlet [A]

Standard IEC receptacle for connection of AC mains. RedNet D16/D16Rs feature 'Universal' PSUs, enabling them to operate on any supply voltage of between 100 V and 240 V.

Note that initial use requires fitment of the plug retaining clip – see page 8

1a IEC Mains Inlet B

D16R

Input connector for backup mains power source. Power supply B remains on standby but will seamlessly take over if PSU A develops a fault or loses its mains input supply.

If an uninterruptible supply (UPS) is available, it is recommended that this is applied to input B.

2. Primary Network Port

RJ45 [etherCON] connector for the Dante network. Use standard Cat 5e or Cat 6 network cable to connect to a local Ethernet switch to connect the RedNet D16/D16R to the RedNet network. Adjacent to each network socket are LEDs which illuminate to indicate a valid network connection plus network activity. *See page 13 for connector details.*

3. Secondary Network Port

Secondary Dante network connection where two independent Ethernet links are being used (Redundant mode) or an additional port on an integral network switch on the primary network (Switched mode).

4. Word Clock Out

Provides an output of the chosen system clock reference (can be switched between base rate or network rate).

5. Word Clock In

Allows synchronisation of the Dante network to house word clock.

6. S/PDIF:

- **OUT** – Provides any adjacent odd-even signal pair, eg. 3–4 or 11–12. Software selectable.
- **IN** – Can be used as an alternative input for audio channels 3–4. Software switchable.

Rear Panels ... Continued

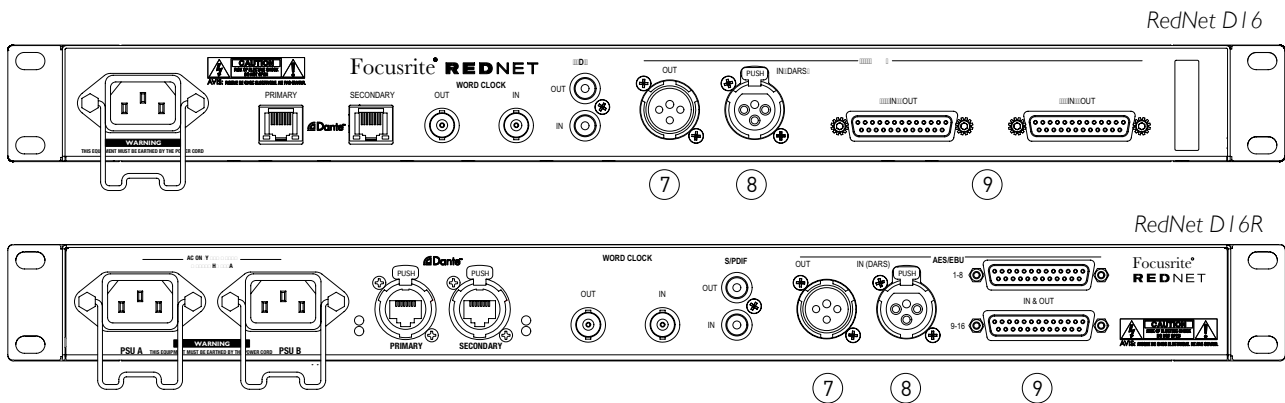

7. XLR Out

Permanent AES/EBU output of audio channel pair 1–2.

8. XLR In

Can be used as an alternate AES/EBU audio source for channels 1–2. Software switchable. May also be used as a clock source when fed with either AES/EBU or DARS (Digital Audio Reference Signal – AES/EBU distributed clock as per AES11). Software selectable.

9. DB25 Connectors

Eight AES/EBU input and output channels per connector. Wired to AES59 Combined Digital I/O. See page 13 for connector pinouts.

Power Connection

IEC Power Cord Retaining Clip

RedNet D16/D16R is supplied with IEC power cord retaining clips. These prevent accidental disconnection of a power cord during use. When the unit is first installed, the retaining clips will need to be attached to power input socket[s] on the rear panel.

Insert each clip by squeezing together the legs as shown in the first image below, aligning the pins with the through-holes on the IEC fixing posts one at a time, and then releasing.

Ensure that the orientation of each clip is as shown in the other images below or the effectiveness will be compromised.

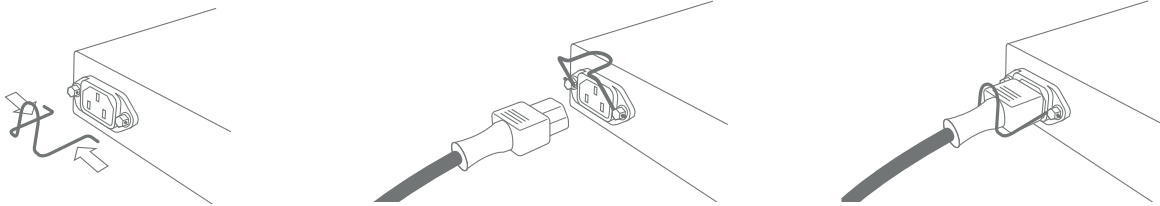

Physical Characteristics

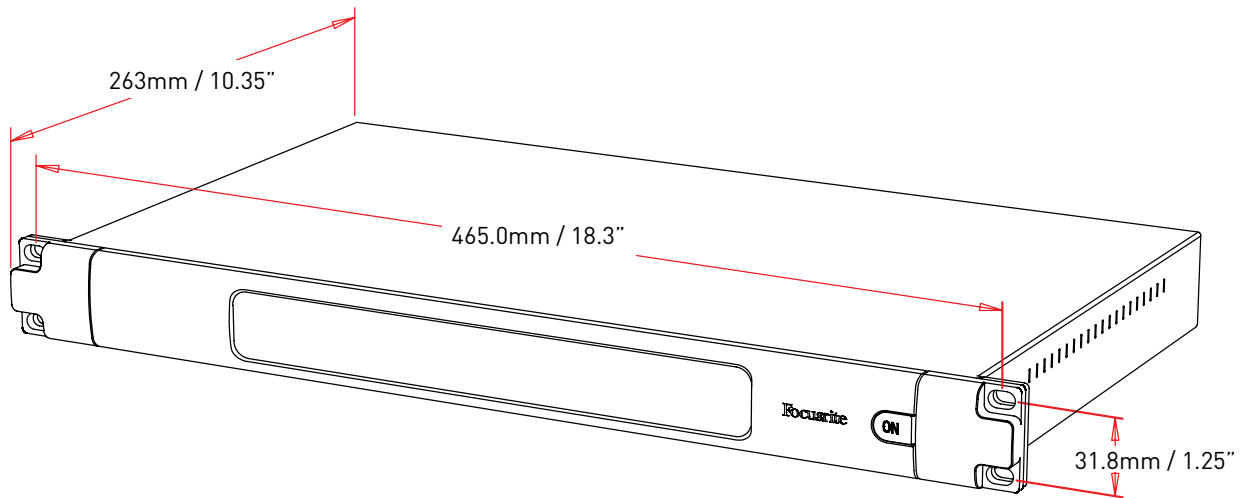

RedNet D16/D16R dimensions are illustrated in the diagram above.

RedNet D16/D16R requires 1U of vertical rack space and at least 350 mm of rack depth, to allow for cables. RedNet D16/D16R weighs 3.74 [3.84] kg and for installations in a fixed environment (eg., a studio), the front-panel mounting screws will provide adequate support. If the units are to be used in a mobile situation (eg., flight-cased for touring, etc.), consideration should be given to using side support rails within the rack.

RedNet D16/D16R generates little significant heat and is cooled by natural convection. The ambient operating temperature of the device is 50 degrees Celcius.

Ventilation is via slots in the enclosure at both sides. Do not mount RedNet D16/D16R immediately above any other equipment which generates significant heat, for example, a power amplifier. Also, ensure that when mounted in a rack, the side vents are not obstructed.

Power Requirements

RedNet D16/D16R is mains-powered. It incorporates a 'Universal' power supply, which can operate on any AC mains voltage from 100 V to 240 V. The AC connection is made via a standard 3-pin IEC connector[s] on the rear panel.

D16R

When PSU A & PSU B are both connected, PSU A becomes the default supply and therefore draws more current than B. If a backup mains supply is provided from an uninterruptible source, it is recommended that this is connected to input B.

One or two mating IEC cables are supplied with the unit – these should be terminated with mains plugs of the correct type for your country.

The AC power consumption of the RedNet D16/D16R is 30VA.

Please note that there are no fuses in RedNet D16/D16R, or other user-replaceable components of any type. Please refer all servicing issues to the Customer Support Team (see "Customer Support and Unit Servicing" on page 16).

REDNET D16/D16R OPERATION

First Use and Firmware Updates

Your RedNet D16/D16R may require a firmware update* when it is first installed and switched on. Firmware updates are initiated and handled automatically by the RedNet Control application.

**It is important that the firmware update procedure is not interrupted – either by switching off power to the RedNet D16/D16R unit or the computer on which RedNet Control is running, or by disconnecting either from the network.*

From time to time Focusrite will release RedNet firmware updates within new versions of RedNet Control. We recommend keeping all RedNet units up to date with the latest firmware version supplied with each new version of RedNet Control.

Digital Clocking

Each RedNet D16/D16R will automatically lock to a valid Network Master via its Dante connection. Alternatively, If a Network Master is not present, then the unit can be chosen as the Network Master by the user.

Pull Up and Pull Down Operation

RedNet D16/D16R is able to operate at a specified pull up or pull down percentage as selected in the Dante Controller application.

Sample Rate Converters

SRC will need to be switched in for any sources that are not using the current system clock as a reference signal.

SRC can be switched in or out separately for each input channel pair.

Note that engaging the sample rate converters will increase the overall latency of the device.

OTHER REDNET SYSTEM COMPONENTS

The RedNet hardware range includes various types of I/O interface and PCIe/ PCIeR digital audio interface cards which are installed in the system's host computer or in a chassis. All the I/O units can be considered as "Break-Out" (and/or "Break-In") boxes to/from the network, and all are built in mains-powered, 19" rackmount housings, unless otherwise stated. There are also three software items, RedNet Control (see below), Dante Controller and Dante Virtual Soundcard.

USING REDNET CONTROL

RedNet Control will reflect the status of the RedNet units present in the system, presenting an image representing each hardware unit.

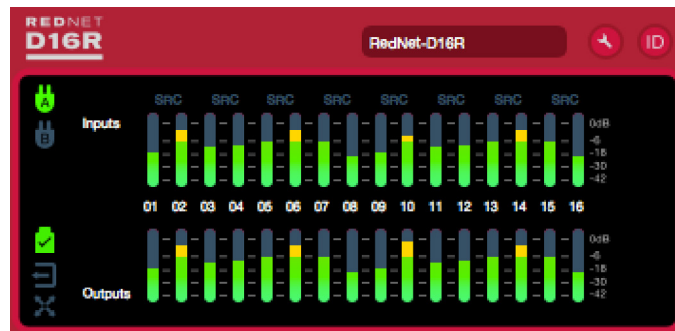

The illustration above shows a RedNet D16R with all input and output signals present with no SRC's switched on. The device is using PSU A and is locked to the network.

D16R



PSUs A & B – Each illuminates if PSU has power input and all DC outputs are present



Networks – Each illuminates if a valid connection is present.



Locked – Unit is successfully locked to the network (changes to the red cross if not locked).



Network Master – Illuminated, indicating that unit is network master.



External Clock – Green: Illuminates when external clock is selected and locked.

Amber: Illuminates when external clock is selected but not locked.



Red: Illuminates when external clock is selected but not connected.

Signal Metering

Each input and output channel has a virtual signal indicator. Five different states are represented:

Black: No signal present

Dim green: > -126 dBFS

Green: -42 dBFS

Amber: -6 dBFS

Red: 0 dBFS

-SRC- : Indicates sample rate converters are switched in for an input channel pair.

ID (Identification)

Clicking on the ID icon  will identify the physical device being controlled by flashing its front panel LEDs.

Tools Menu

Clicking on the Tools icon  will gain access to the following system settings:

Input 1–2 from XLR – Tick option On/Off. Replaces channels 1–2 on the DB25 connector.

Input 3–4 from RCA – Tick option On/Off. Replaces channels 3–4 on the DB25 connector.

RCA Output Source – Only one can be selected at any time.

- Channels 1–2
- Channels 3–4
- Channels 5–6
- Channels 7–8
- Channels 9–10
- Channels 11–12
- Channels 13–14
- Channels 15–16

Preferred Master – On/Off state.

RedNet Clock Source – Only one of the following can be selected at any time.

- Internal (RedNet is network master but running from internal clock)
- Word Clock Input
- XLR Input (DARS)
- DB-25 (Input pair 1)
- DB-25 (Input pair 5)

Note: When selecting any clock source, RedNet DI 6/DI 6R will become a preferred master.

Word Clock Input Termination – Tick option On/Off. (Terminates word clock input BNC with 75Ω.)

Word Clock Output – One can be selected at any time.

- Network
- Network (Base Rate)

Sample Rate Convertors – Each option an On/Off toggle. Can be switched separately.

- Channels 1–2
- Channels 3–4
- Channels 5–6
- Channels 7–8
- Channels 9–10
- Channels 11–12
- Channels 13–14
- Channels 15–16

APPENDIX

Connector Pinouts

Ethernet Connector

Connector type: RJ-45 receptacle
 Applies to: Ethernet (Dante)

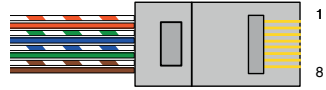

Pin	Cat 6 Core
1	White + Orange
2	Orange
3	White + Green
4	Blue
5	White + Blue
6	Green
7	White + Brown
8	Brown

DB-25 (AES59) Connector

Connector type: DB-25 receptacle
 Applies to: AES/EBU I/O

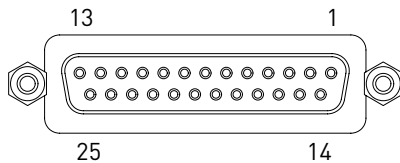

Pin	Signal
1	Out channels 7/8 +
14	Out channels 7/8 -
2	Ground
15	Out channels 5/6 +
3	Out channels 5/6 -
16	Ground
4	Out channels 3/4 +
17	Out channels 3/4 -
5	Ground
18	Out channels 1/2 +
6	Out channels 1/2 -
19	Ground
7	In channels 7/8 +
20	In channels 7/8 -
8	Ground
21	In channels 5/6 +
9	In channels 5/6 -
22	Ground
10	In channels 3/4 +
23	In channels 3/4 -
11	Ground
24	In channels 1/2 +
12	In channels 1/2 -
25	Ground
13	n/c

XLR Connectors

Connector type: XLR-3 receptacle
 Applies to: AES/EBU / DARS Input

Connector type: XLR-3 plug
 Applies to: AES/EBU Output

Pin	Signal
1	Screen
2	Hot (+ve)
3	Cold (-ve)

PERFORMANCE AND SPECIFICATIONS

Input Sample Rate Converters	
Sample Rate Range	32 to 216 kHz
Gain Error	-0.3 dB
Dynamic Range	> 138 dB (-60 dBFS method)
THD+N	< -130 dB (0.00003%); 0 dBFS input
Latency	11 to 45 samples (network and input sample rate dependent)

Digital Performance	
Supported Sample Rates	44.1 / 48 / 88.2 / 96 / 176.4 / 192 kHz (-4% / -0.1% / +0.1% / +4.167%) at 24 bit
Clock Sources	Internal, Word Clock, DARS, AES input 1-2, AES/EBU input 9-10 or from Dante Network Master
External Word Clock Range	Nominal sample rate $\pm 7.5\%$

Rear Panel Connectivity	
AES/EBU	
Channel Count	16 x 16 AES/EBU channels
Input and Output	2 x DB-25 connectors (AES59 Combined I/O / Tascam Digital)
Alternate Input (Optional DARS)	1 x Female XLR (replaces DB-25 channels 1-2)
Alternate Output	1 x Male XLR (duplicates DB-25 channels 1-2)
S/PDIF	
Channel Count	2 x 2 S/PDIF Channels (reduces AES/EBU input channels)
Input	1 x RCA phono socket (replaces DB-25 channels 3-4)
Output	1 x RCA phono socket (switchable, duplicates any DB-25 channel pair)
Word Clock	
Input	1 x BNC 75 Ω port (switchable termination)
Output	1 x BNC 75 Ω port
PSU & Network	
PSU	1 [2] x IEC Inputs with retaining clips
Network	2 x RJ45 [2 x etherCON NE8FBH-S, also compatible with standard RJ45 connectors (Accommodates rugged etherCON NE8MC*. Does not intermate with Cat 6 cable connector NE8MC6-MO and NKE65* cable)]

Front Panel Indicators	
Power [PSU A]	Green LED. Illuminates when an AC input is applied and all DC outputs are present
PSU B <i>[DI 6R only]</i>	Green LED. Illuminates when an AC input is applied and all DC outputs are present
Primary Network	Green LED. Indicates that a network connection is present on primary port when in redundant mode. When in Switched mode, a valid network connection at either Primary or Secondary network port will cause this LED to illuminate
Secondary Network	Green LED. Indicates that a network connection is present on secondary port when in redundant mode. Not used in switched mode
Network Locked	Green LED. When unit is network slave, shows valid network lock. When network master, shows unit is locked to indicated clock source. Flashing indicates external clock is selected but not connected
Sample Rate	Orange LED for each: 44.1 kHz, 48 kHz, x2, x4
Pull Up/Down	Orange LED. Indicates unit is set to operate on a Dante pull up/down domain
Signal Indicators	16 Green LEDs: 8 input/8 output indicators. Illuminate at -126 dBFS
Clock Source	Orange LED for each: Internal, Word Clock, DARS, Input 1–2, Input 9–10

Network Modes	
Redundant	Allows unit to connect to two independent networks
Switched	Connects both ports to integrated network switch allowing daisy-chaining of devices

Dimensions	
Height	44.5mm / 1.75" (1RU)
Width	482.6mm / 19"
Depth	263mm / 10.35"

Weight	
Weight	3.74 [3.84] kg

Power	
PSU[s]	1 [2] x Internal, 100-240V, 50/60Hz, consumption 30VA

Focusrite RedNet Warranty and Service

All Focusrite products are built to the highest standards and should provide reliable performance for many years, subject to reasonable care, use, transportation and storage.

Very many of the products returned under warranty are found not to exhibit any fault at all. To avoid unnecessary inconvenience to you in terms of returning the product please contact Focusrite support.

In the event of a Manufacturing Defect becoming evident in a product within 12 months from the date of the original purchase Focusrite will ensure that the product is repaired or replaced free of charge.

A Manufacturing Defect is defined as a defect in the performance of the product as described and published by Focusrite. A Manufacturing Defect does not include damage caused by post-purchase transportation, storage or careless handling, nor damage caused by misuse.

Whilst this warranty is provided by Focusrite the warranty obligations are fulfilled by the distributor responsible for the country in which you purchased the product.

In the event that you need to contact the distributor regarding a warranty issue, or an out-of-warranty chargeable repair, please visit: www.focusrite.com/distributors

The distributor will then advise you of the appropriate procedure for resolving the warranty issue. In every case it will be necessary to provide a copy of the original invoice or store receipt to the distributor. In the event that you are unable to provide proof of purchase directly then you should contact the reseller from whom you purchased the product and attempt to obtain proof of purchase from them.

Please do note that if you purchase a Focusrite product outside your country of residence or business you will not be entitled to ask your local Focusrite distributor to honour this limited warranty, although you may request an out-of-warranty chargeable repair.

This limited warranty is offered solely to products purchased from an Authorised Focusrite Reseller (defined as a reseller which has purchased the product directly from Focusrite Audio Engineering Limited in the UK, or one of its Authorised Distributors outside the UK). This Warranty is in addition to your statutory rights in the country of purchase.

Registering Your Product

For access to Dante Virtual Soundcard, please register your product at: www.focusrite.com/register

Customer Support and Unit Servicing

You can contact our dedicated RedNet Customer Support team free of charge:

Email: rednetsupport@focusrite.com

Phone (UK): +44 (0)1494 462246

Phone (USA): +1 (310) 322-5500

Troubleshooting

If you are experiencing problems with your RedNet D16/D16R, we recommend that in the first instance, you visit our Support Answerbase at: www.focusrite.com/answerbase