

dbx[®]
by HARMAN

ZonePRO™

Digital Zone Processors

640, 640m

641, 641m

1260, 1260m

1261, 1261m



Installation Guide

Section 1 - Introduction 1

- 1.1 ZonePRO Overview1
- 1.2 Features.....1
- 1.3 ZonePRO Support Resources2
- 1.4 Service Contact Info2
- 1.5 Warranty3

Section 2 - ZonePRO Designer GUI..... 4

- 2.1 ZonePRO Designer Overview4
- 2.2 GUI System Requirements.....4
- 2.3 GUI Installation.....5
- 2.4 Quick Start – Connecting via RS-2325

Section 3 - Getting Started..... 8

- 3.1 Front Panel – 640/640m, 1260/1260m8
- 3.2 Front Panel – 641/641m, 1261/1261m9
- 3.3 Rear Panel.....10

Section 4 - Zone Controllers 12

- 4.1 ZC Descriptions12
- 4.2 ZC Wiring15
- 4.3 ZC-4 Wiring18
- 4.4 ZC DIP Switches & Programming.....19

Section 5 - Link I/O..... 22

- 5.1 Link I/O Overview22
- 5.2 Jumpers.....22
- 5.3 Link I/O Wiring.....24

Section 6 - Networking 25

- 6.1 Default ZonePRO Network Settings.....25
- 6.2 Networking Overview25
- 6.3 Overview of TCP/IP Basics26
- 6.4 Connecting via direct-connect Ethernet.....27
- 6.5 Setup of a simple isolated Ethernet network28
- 6.6 Adding the ZonePRO to an existing Local Area Network30
- 6.7 Proxy.....31
- 6.8 Virtual Private Networks (VPN)32
- 6.9 Network Considerations and Limitations32
- 6.10 Network Troubleshooting33

Section 7 - Application Guide 34

- 7.1 Restaurant Application.....34
- 7.2 Health Club Application36
- 7.3 Nightclub Application38

Section 8 - Appendix 40

- 8.1 ZonePRO 640/641 Block Diagram.....40
- 8.2 ZonePRO 640m/641m Block Diagram41
- 8.3 ZonePRO 1260/1261 Block Diagram42
- 8.4 ZonePRO 1260m/1261m Block Diagram43
- 8.5 Firmware Updates.....44
- 8.6 Factory Reset Procedures.....44
- 8.7 Technical Specifications46
- 8.8 Wiring Diagrams.....51
- 8.9 Copyrights.....52

Section 1 - Introduction

1.1 ZonePRO Overview

Congratulations on your purchase of the dbx® ZonePRO. The ZonePRO products are based on the same unparalleled design philosophy that made the DriveRack family famous. This philosophy, “To provide everything you need between the sources and the amplifiers”, creates a full-featured processor capable of almost any BGM or commercial audio application.

The proceeding chart outlines the major differences between the dbx ZonePRO models.

	Total Inputs	Total Outputs	Balanced Mic/Line Inputs	Unbalanced RCA Line Inputs	2 Channel S/PDIF Input	Front Panel Control	Ethernet Port	Mix Sources to Zones	Ambient Noise Compensation
1260m	12	6	6	4 Pair	✓	✓	✓	✓	✓
1260	12	6	2	8 Pair	✓	✓	✓	✓	
1261m	12	6	6	4 Pair	✓		✓	✓	✓
1261	12	6	2	8 Pair	✓		✓	✓	
640m	6	4	4	2 Pair		✓	✓	✓	✓
640	6	4	2	4 Pair		✓			
641m	6	4	4	2 Pair			✓	✓	✓
641	6	4	2	4 Pair					

1.2 Features

- *Advanced Feedback Suppression (AFS™)*
- *AutoWarmth®*
- *Auto Gain Control (AGC)*
- *Ambient Noise Compensation (640m, 641m, 1260m, & 1261m models only)*
- *Bandpass/Crossover Filters*
- *Compression*
- *Delay*
- *De-Essing*
- *Limiting*
- *Noise Gating*
- *Notch Filtering*
- *Parametric EQ*
- *2 Level Priority Ducker*
- *Configuration, Scene, & Schedule Wizards*
- *Compatible with dbx ZC Wall Panel Controllers*
- *Independent Routing of Sources to Zones*
- *Independent Mixing of Sources to Zones (640 & 641 do not support source mixing)*
- *Independent Zone Volume & Source Selection Control*
- *RS-232 & Ethernet Control (640 & 641 models do not support Ethernet control)*
- *Security Lockout*
- *Switchable Mic/Line Inputs*
- *IEC, UI, and CSA Certified*

1.3 ZonePRO Support Resources

ZonePRO Designer Help - After installing the ZonePRO Designer GUI, see the included help for detailed information regarding ZonePRO programming and configuration.

Training Videos - Training videos can be found under the “Training” section of the dbx website located at www.dbxpro.com.

FAQs/Solutions - Answers to frequently asked questions and solutions to common problems can be found under the “Support” section at www.dbxpro.com.

dbx User Forum - The dbx User Forum can be found at www.dbxpro.com. Here you can search the forum for specific topics or ask other ZonePRO users questions regarding the ZonePRO products.

1.4 Service Contact Info

If you require technical support, contact dbx Technical Support. Be prepared to accurately describe the problem. Know the serial number of your device – this is printed on a sticker attached to the chassis.

Before you return a product to the factory for service, we recommend you refer to this manual. Make sure you have correctly followed installation steps and operating procedures. For further technical assistance or service, please contact our Technical Support Department at (801) 566-8800 or visit dbxpro.com. If you need to return a product to the factory for service, you **MUST** first contact our Technical Support Department to obtain a Return Authorization Number.

NO RETURNED PRODUCTS WILL BE ACCEPTED AT THE FACTORY WITHOUT A RETURN AUTHORIZATION NUMBER.

Please refer to the Warranty information, which extends to the first end-user. After expiration of the warranty, a reasonable charge will be made for parts, labor, and packing if you choose to use the factory service facility. In all cases, you are responsible for transportation charges to the factory. If the product is still under warranty, dbx will pay the return shipping.

Use the original packing material if it is available. Mark the package with the name of the shipper and with these words in red: DELICATE INSTRUMENT, FRAGILE! Insure the package properly. Ship prepaid, not collect. Do not ship parcel post.

1.5 Warranty

1. Please register your product online at dbxpro.com. Proof-of-purchase is considered to be the responsibility of the consumer. A copy of the original purchase receipt must be provided for any warranty service.
2. dbx warrants this product, when purchased new from an authorized U.S. dbx dealer and used solely within the U.S., to be free from defects in materials and workmanship under normal use and service. This warranty is valid to the original purchaser only and is non-transferable.
3. dbx liability under this warranty is limited to repairing or, at our discretion, replacing defective materials that show evidence of defect, provided the product is returned to dbx WITH RETURN AUTHORIZATION from the factory, where all parts and labor will be covered up to a period of two years. A Return Authorization Number must first be obtained from dbx. The company shall not be liable for any consequential damage as a result of the product's use in any circuit or assembly.
4. dbx reserves the right to make changes in design or make additions to or improvements upon this product without incurring any obligation to install the same additions or improvements on products previously manufactured.
5. The foregoing is in lieu of all other warranties, expressed or implied, and dbx neither assumes nor authorizes any person to assume on its behalf any obligation or liability in connection with the sale of this product. In no event shall dbx or its dealers be liable for special or consequential damages or from any delay in the performance of this warranty due to causes beyond their control.

Section 2 - ZonePRO Designer GUI

2.1 ZonePRO Designer Overview

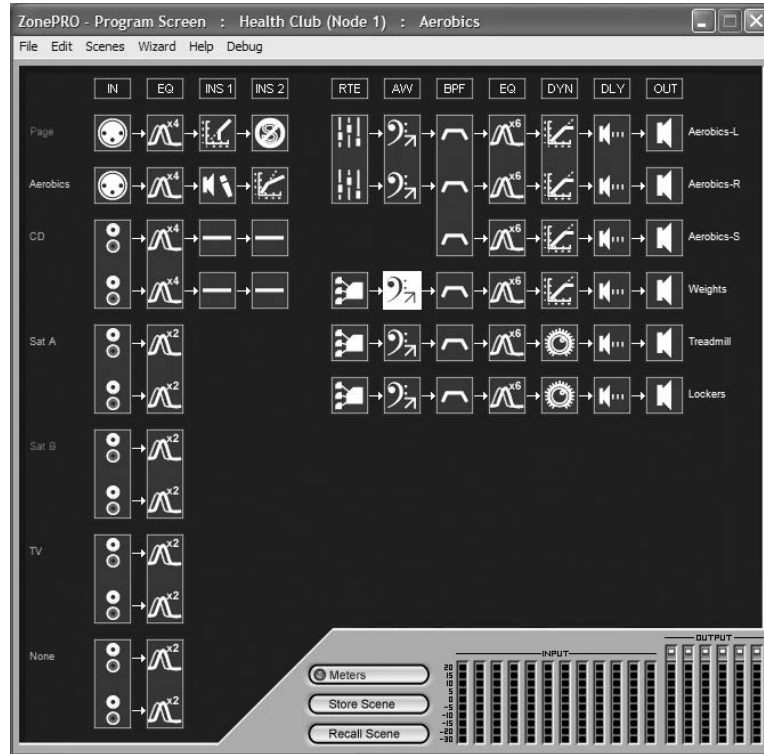

The ZonePRO Designer Graphic User Interface (GUI) is the software application which is used for programming the ZonePRO products. The GUI provides network tools for configuring your control network as well as multiple “Wizard” functions for configuring the system routing and in-wall dbx Zone Controllers. The GUI also allows you to adjust DSP effect parameters and even create automatic system changes (referred to as “Scene Changes”).

Understanding the ZonePRO Designer GUI is essential for getting the most out of the ZonePRO processors. After installing the ZonePRO Designer GUI, please see the software application’s help section for detailed information and assistance with the ZonePRO Designer GUI. Training videos are also available at www.dbxpro.com.

2.2 GUI System Requirements

1 GHz or faster processor
 Windows 2000/XP/Vista (32 bit)/7 (32 bit)
 256 MB RAM (512 MB Recommended)
 Recommended screen resolution: 1024 x 768 pixels or higher

2.3 GUI Installation

1. Download the ZonePRO Designer GUI software from www.dbxpro.com then launch the installer.

! It's recommended that virus protection software be disabled during ZonePRO Designer installation.

2. Follow the installer's instructions to complete the installation.

2.4 Quick Start – Connecting via RS-232

In order to program the ZonePRO processors, the ZonePRO Designer GUI must be in communication with the ZonePRO device (this is referred to as "Online"). Once communication is established, the ZonePRO processor can be programmed in real time, or if a program has already been created, it can be loaded into the device.

If your computer does not have a built in RS-232 port you must use a compatible RS-232 peripheral, such as an RS-232 PCI card, RS-232 PCMCIA card, or USB to Serial adapter. Please visit the FAQs section of the dbx website for the latest information on compatible RS-232 peripherals.

Most ZonePRO models also allow you to communicate via Ethernet, the exception being the 640 and 641 models, which do not have an Ethernet control port. If you are connecting via Ethernet and require assistance, please see "Section 6 - Networking".

! It is highly recommended that ZonePRO installers do have the means to communicate with the ZonePRO processors via RS-232. If a firmware update is ever required, the firmware update must be applied using the RS-232 connection!

Going Online via RS-232

1. Connect your computer to the ZonePRO's front or rear RS-232 port using the provided dbx female to female null modem cable.

! A straight-through RS-232 cable will not work! If using a USB to Serial adapter, the dbx null modem cable must be plugged in between the adapter and the ZonePRO. See section "8.8 Wiring Diagrams" for a wiring diagram of the RS-232 null modem cable.

2. Launch ZonePRO Designer.

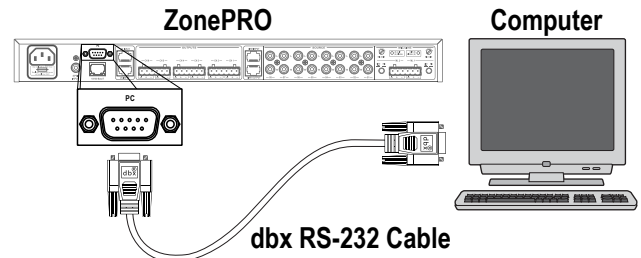

3. Wait approximately 10 seconds after the main ZonePRO Designer window has appeared. If a ZonePRO icon appears in the upper left hand corner of the window, you are online with the processor and ready to begin programming. Simply double left click on the ZonePRO icon to open the Program Screen and begin programming. If the icon does not automatically appear, proceed with these instructions.



4. Go into Window's Device Manager > Ports. Take note of your COM port's assigned COM number (shown in parenthesis). If you do not see your COM port here, you may need to reinstall the drivers for your COM port peripheral.

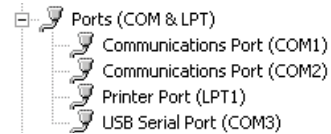

5. Double left click on the connected COM port listed in the previous step. Click the Port Settings tab and set your COM port settings as shown to the right then click the OK button.

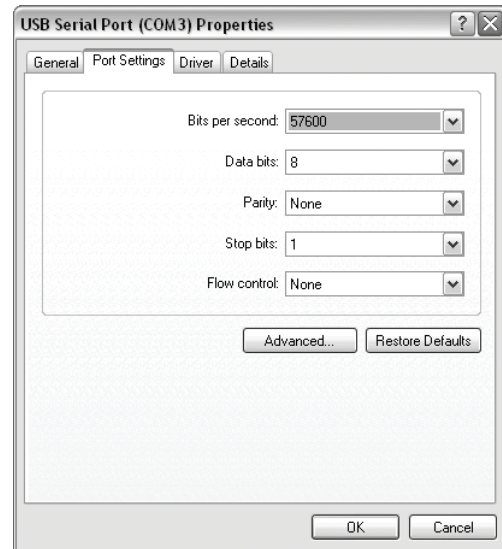

6. Go back into ZonePRO Designer and go to Network > Properties.

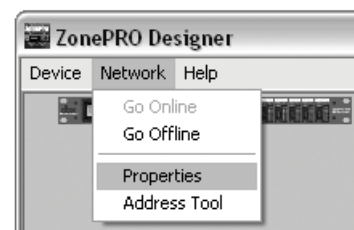

7. Ensure that the “Automatically go online when the application starts” option is checked and the “Use serial ports” option is checked. In the COM Ports combo box, uncheck any unused COM ports and check only the COM port number which you noted in step 4. Click the Next button twice.

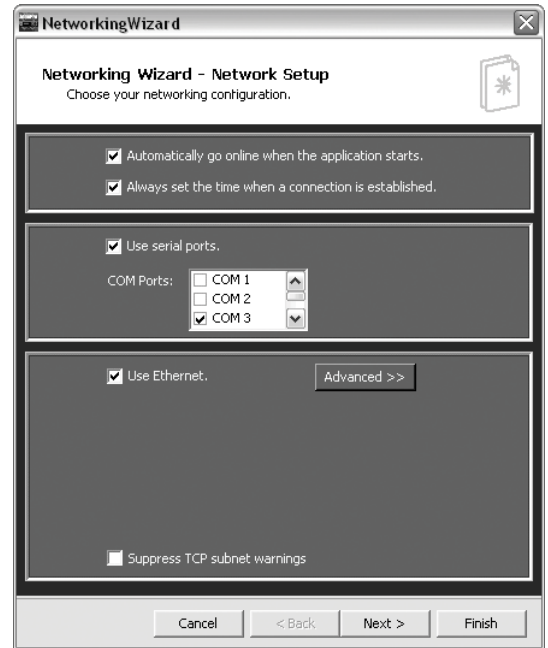

8. Your connected ZonePRO device should appear on the second row of the table and have a Status of “Resolved”. If it does not, ensure that the RS-232 cable is securely connected and that you are using the correct RS-232 cable and a compatible RS-232 peripheral. If the ZonePRO device appears in the table proceed by clicking the Finish button.

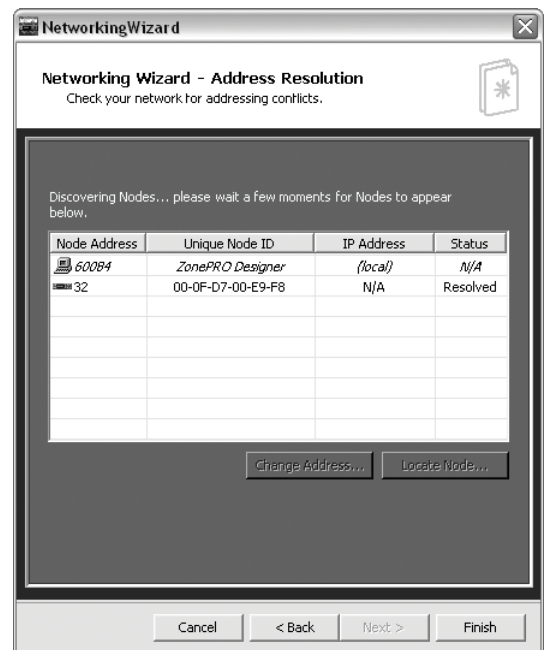

9. Select Network > Go Online. The icon of the ZonePRO should now appear in the upper left corner of the window. You are now online with the processor and ready to begin programming. Simply double left click on the ZonePRO icon to open the Program Screen and begin programming.

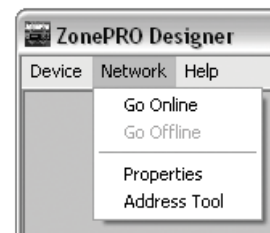

Section 3 - Getting Started

3.1 Front Panel – 640/640m, 1260/1260m

640 Front Panel

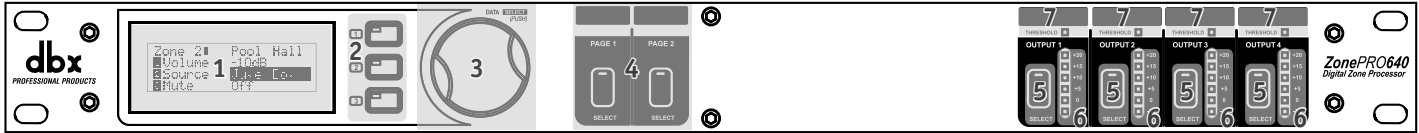

640m Front Panel

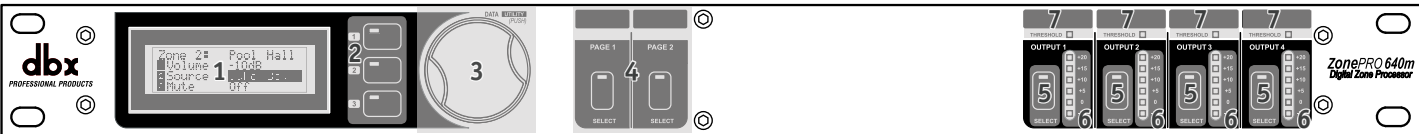

1260 Front Panel

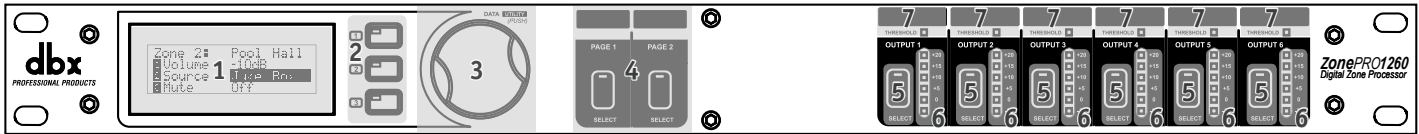

1260m Front Panel

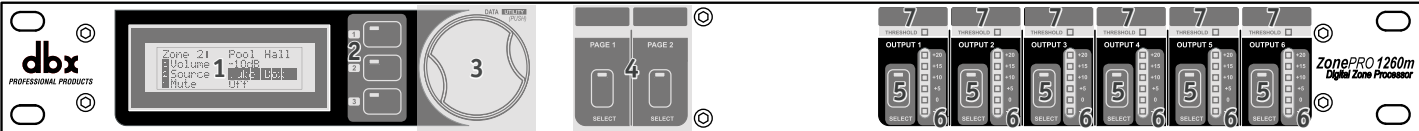

1. Front Panel LCD

Displays information relating to parameters such as source selection, page steering, zone volumes, and mutes.

2. Parameter Select Buttons 1-3

Allows selection of parameters on display.

3. Data Wheel

Used to edit parameter values.

4. Page Buttons

Allows paging microphone path selection for page steering of the ML1 and ML2 inputs.

5. Output Select Button

Allows selection of outputs for controlling source selection, zone volume control, and zone muting.

6. Output Meter

Six-segment output level meter representing -30dBu to +20dBu.

7. Threshold Indicator

Indicates that the threshold level has been exceeded within the output dynamics processor and that dynamics processing may be occurring.

3.2 Front Panel – 641/641m, 1261/1261m

641 Front Panel

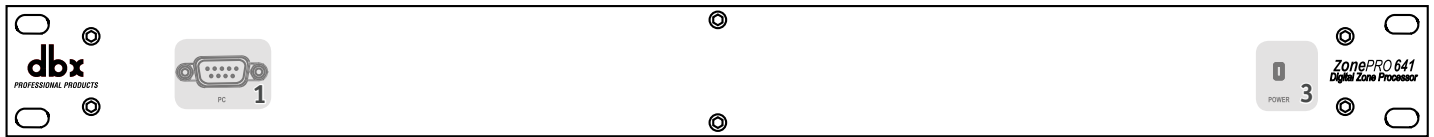

641m Front Panel

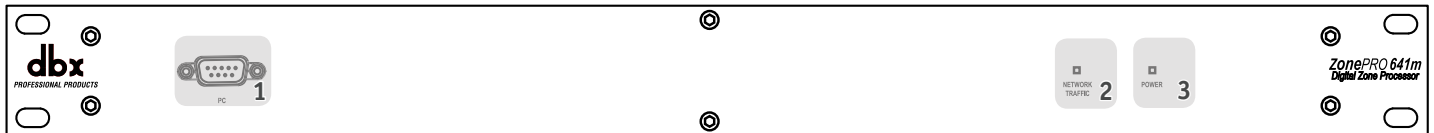

1261 Front Panel

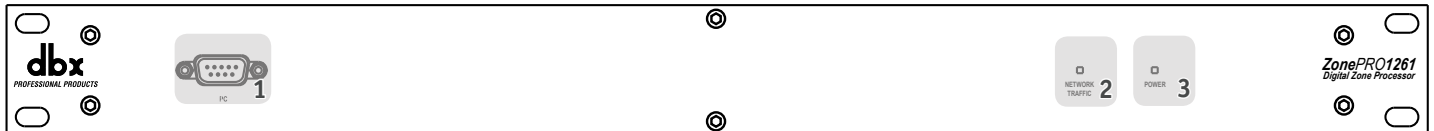

1261m Front Panel

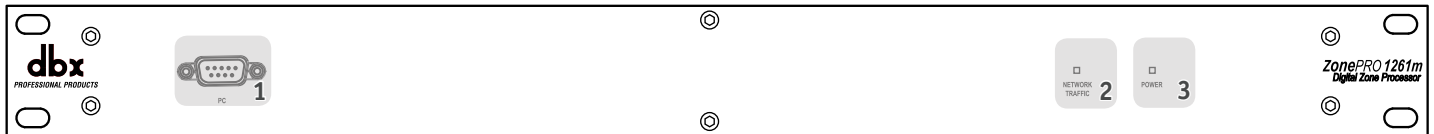

1. Front PC Port (RS-232)

Connect this serial port to the PC for configuration, control, and monitoring. It can also be used for communication with a third party control system. The baud rate of this port is 57600.

⚠ Front and rear PC ports should not be used at the same time!

2. Network Traffic LED (641m, 1261, and 1261m only)

This LED (when lit), indicates that network traffic is present.

3. Power LED

This LED (when lit) indicates that the ZonePRO device is currently powered on.

3.3 Rear Panel

640/64I Rear Panel

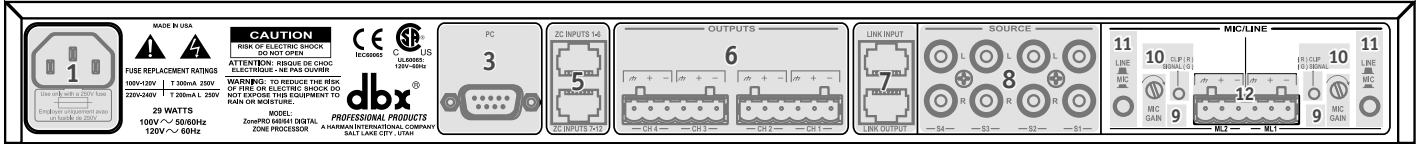

640m/64Im Rear Panel

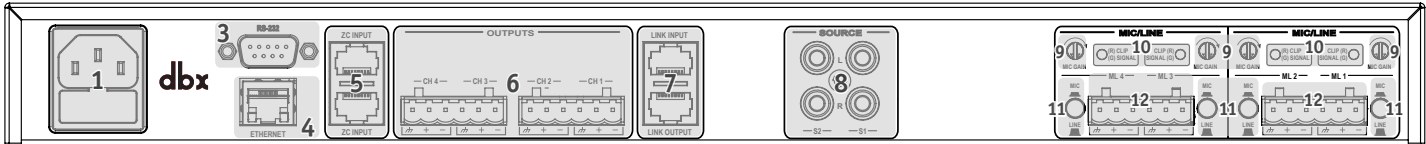

1260/126I Rear Panel

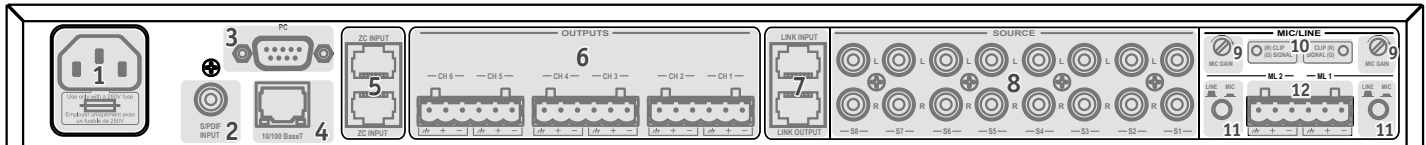

1260m/126Im Rear Panel

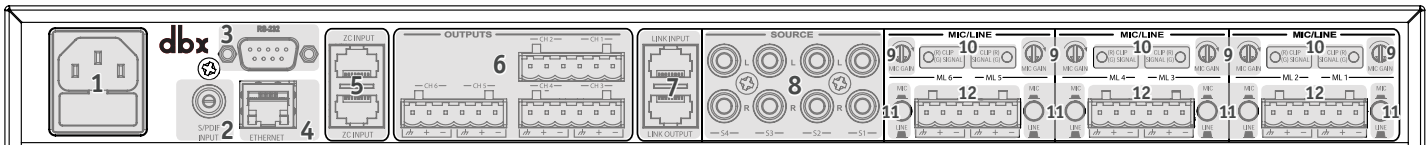

1. Power Connector

Connect the included AC power cable to this IEC connector.

2. S/PDIF Input (1260, 126I, 1260m, and 126Im models only)

Digital audio input for up to two channels of digital audio.

3. Rear PC Port (RS-232)

Connect this serial port to the PC for configuration, control, and monitoring. It can also be used for communication with a third party control system. The baud rate of this port is 57600.

⚠ Front and rear PC ports should not be used at the same time!

4. Ethernet Port (all models except 640 and 64I)

Connect this Ethernet port to the PC for configuration, control, and monitoring. It can also be used for communication with a third party control system.

5. ZC Input Ports

Allows connection of up to 12 ZC controllers (six per port) for control of volume, source selection, page steering, and scene changes. The top ZC Input port is for IDs 1-6 and the bottom ZC Input port is for IDs 7-12.

6. Analog Outputs

Balanced audio output connections. Connect these outputs to your amplifier input channels.

7. Link Input/Output Ports

Allows duplication of up to six input channels (ML1, ML2, S1, S2, S3, S4) to another ZonePRO device in applications where additional output zones are required.

⚠ All models – with the exception of the 640m and 641m – allow duplication of up to six channels: ML1, ML2, S1, S2, S3, S4. The 640m and 641m models allow duplication of up to four channels: ML1, ML2, S1, S2.

8. RCA Source Inputs

Mono-summed pairs of unbalanced RCA audio inputs.

⚠ Each pair of unbalanced RCA inputs are internally mono summed. This is beneficial when your application requires mono zones. However, when stereo zones are required and stereo imaging is to be maintained, each stereo source must occupy two pairs of inputs (omitting one jack per pair).

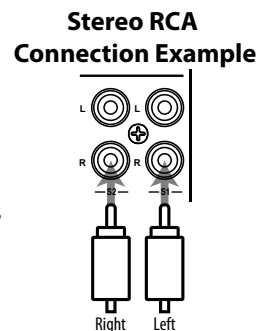

9. Mic Gain Control

Allows microphone gain control when the mic/line inputs are set to mic level.

10. Signal/Clip LED

This LED indicates when signal is present (green) or the input is clipping (red).

11. Mic/Line Switch

Allows configuration for microphone or line level sources.

12. Mic/Line Input Connectors

These balanced inputs provide Euroblock connectors for mic or line level sources.

⚠ These Euroblock inputs provide 15 Volts of phantom power when the mic/line switch is set to mic level.

Section 4 - Zone Controllers

4.1 ZC Descriptions

The dbx Zone Controllers (ZCs) provide a user friendly solution for controlling different functions of the ZonePRO processors. The following section provides a description of each of these ZC models.



ZC-1 – The ZC-1 is a programmable zone controller that allows input or output volume level control from a wall panel.

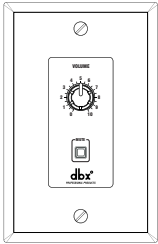

ZC-2 – The ZC-2 is a programmable zone controller that allows output volume level and mute control from a wall panel.

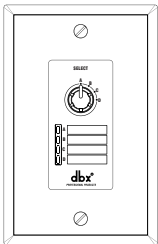

ZC-3 – The ZC-3 is a programmable zone controller that allows control of source selection, page steering, or scene selection via a four position rotary control.

⚠ The ZC-3 must be assigned as ID#1 and connected to the ZonePRO's top ZC Input connector for scene selection control.

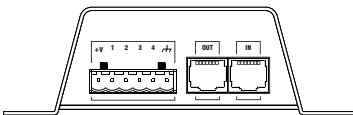

ZC-4 – The ZC-4 is a programmable zone controller that allows control of source selection, page steering, or scene selection via contact closure.

⚠ The ZC-4 must be assigned as ID#1 and connected to the ZonePRO's top ZC Input connector for scene selection control.

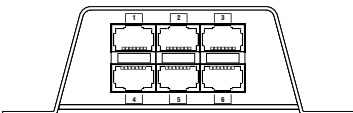

ZC-BOB – The ZC-BOB allows parallel (also known as “home run”) cabling of the Zone Controllers.

⚠ Each ZonePRO device can accommodate up to two ZC-BOBs. Daisy chaining ZCs off the ZC-BOB is not supported!

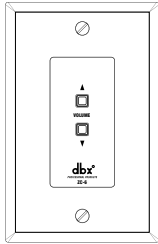

ZC-6 – The ZC-6 is a push-button up/down input or output volume controller.

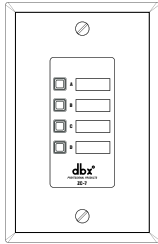

ZC-7 – The ZC-7 is a programmable zone controller that allows control of page steering via four momentary push buttons. The ZC-7 has 5 states: button A pressed, button B pressed, button C pressed, button D pressed, and “no button pressed” being the 5th state.

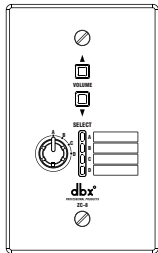

ZC-8 – The ZC-8 is used for combination up/down output volume control and four position source selection control.

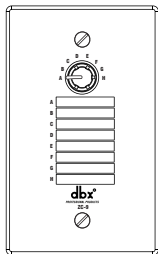

ZC-9 – The ZC-9 provides source selection control via an eight position rotary selector.

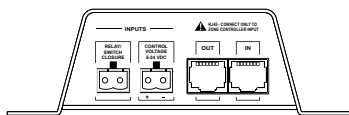

ZC-FIRE – The ZC-FIRE is the interface to generic fire alarm relays. When the fire alarm activates, the general purpose relay can typically be programmed to close if normally open or vices-versa. The ZC-FIRE interface unit monitors the state of the relay (n.o. or n.c.) and upon the state of change, notifies the ZonePRO to mute the outputs or load a pre-programmed “Fire” scene. Control Voltage (5-24 VDC) can also be used for triggering the ZC-FIRE.

⚠ The ZC-FIRE must be assigned as ID#2 and connected to the ZonePRO’s top ZC Input connector for fire control.

The below matrix table shows a side-by-side comparison of the ZC's features.

Zone Controller Comparison Matrix

for ZonePRO™ Digital Zone Processors

		ZONE CONTROLLER									
		ZC-1	ZC-2	ZC-3	ZC-4	ZC-B0B	ZC-6	ZC-7	ZC-8	ZC-9	ZC-FIRE**
FEATURES	Rotary Volume Control	●	●								
	Up / Down Volume Control						●		●		
	Push-Button Mute		●								
	4-Position Selector			●					●		
	8-Position Selector									●	
	4-Button PTT** Page Steering							●			
	Contact Closure(s)				●						●
	"Home Run" RJ-45 Jacks					●					
	Source Selection			●	●				●	●	
	Page Assignment			●	●						
	Scene Selection			●*	●*						●
Output Muting										●	

PTT: Push-To-Talk

*Must be in ZC-position #1

**Must be in ZC-position #2

4.2 ZC Wiring

The installation of the Zone Controllers MUST be accomplished with the use of cable which is rated VW-1 or higher. Common NEC designations which meet this rating include: CMP, CMR, CMG, CM and CMX.

The below diagram shows the internal color coding of a compatible straight-through, 568B standard Cat 5 cable. It also illustrates which DIP switch settings and controller ID numbers correspond with each wire inside the Cat 5 cable.

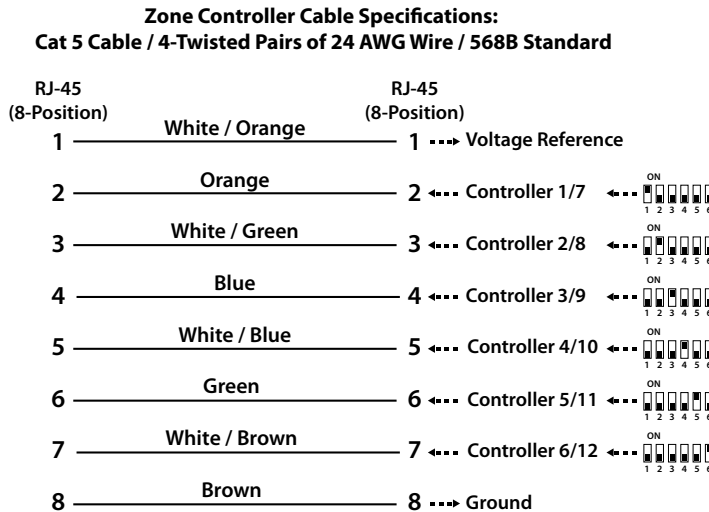

All Zone Controllers can be wired serially or in parallel. Whether using serial or parallel cabling, each Zone Controller must have a unique identification number chosen using the DIP switches on the side of the controller (see Diagram A), although there may be multiple Zone Controllers controlling a single zone or a single Zone Controller that controls multiple zones. This is explained in further detail in “Section 4.4 ZC DIP Switches & Programming”.

Diagram A

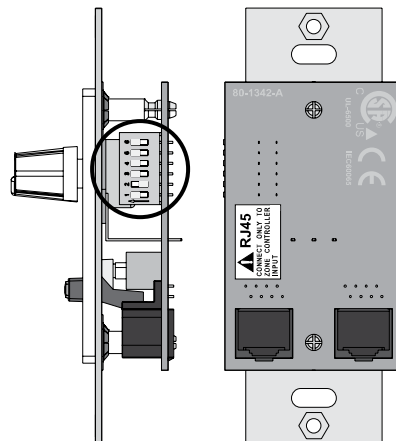

! Two Zone Controllers cannot be used to control the same parameter within the ZonePRO device!

Wiring In Series

To wire the Zone Controllers in series, daisy chain each ZC using the ports on each (see Diagram B) then connect one of the ZCs to the appropriate ZC Input Port on the ZonePRO device. It is not important which ZC port you use on each ZC or which ZC in the chain is connected to the ZonePRO device.

Diagram B

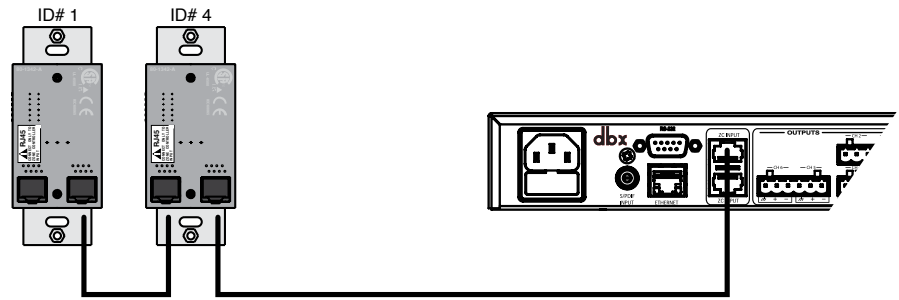

Wiring In Parallel

To wire the Zone Controllers in parallel, a ZC-BOB must be used. To wire in parallel, each Zone Controller must be wired into one of the ZC-BOB's numbered ports. The ZC BOB's Output port is then connected to one of the ZonePRO's ZC Input ports (see Diagram C). For troubleshooting purposes, it is recommended to match the numbered ports on the ZC-BOB with the corresponding DIP switch assignments on each ZC (for example, ID#6 or ID#12 would be connected to the #6 port on the ZC-BOB).

Diagram C

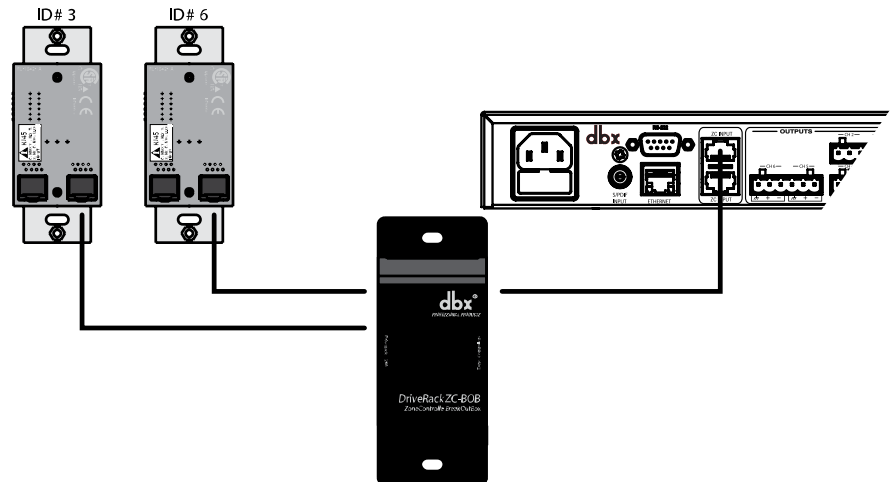

! Each ZonePRO device can accommodate up to two ZC-BOBs. Daisy chaining ZCs off the ZC-BOB is not supported!

Maximum Cable Lengths

Depending upon how many controllers you are connecting to the ZonePRO and whether you are wiring the ZCs in parallel or serially, there are certain cable length restrictions.

Diagram A shows the maximum cable length for 3 ZCs wired in serial. Diagram B shows the maximum cable length for 6 ZCs wired in serial. Diagram C shows the maximum length for each cable run when connecting the ZCs in parallel using a ZC-BOB and the maximum cable length of the cable between the ZC-BOB and ZonePRO device.

Diagram A

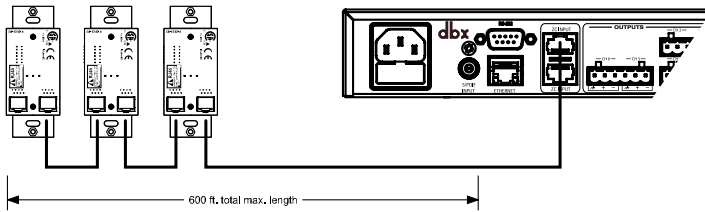

Diagram B

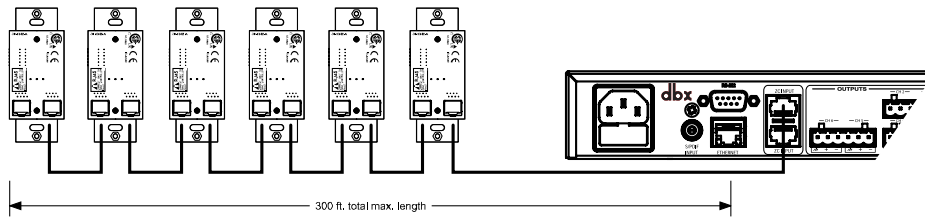
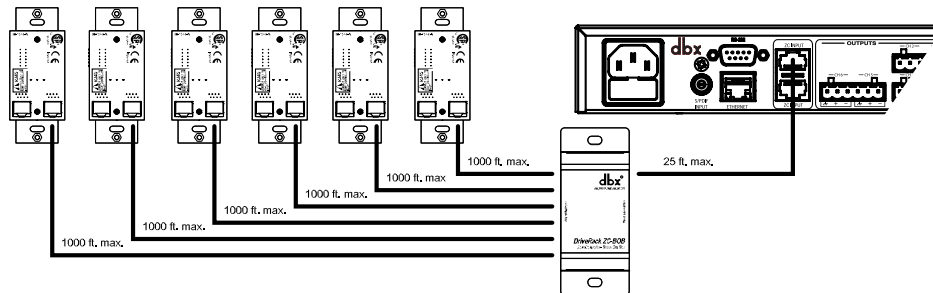

Diagram C



Number of ZCs Daisy Chained in Series	Maximum Total Cable Length
1 ZC	1000 ft.
2 ZCs	800 ft.
3 ZCs	600 ft.
4 ZCs	500 ft.
5 ZCs	400 ft.
6 ZCs	300 ft.

4.3 ZC-4 Wiring

The below diagrams show how to configure and wire a ZC-4 for contact closure control using relays or SPDT (single pole double throw) type switches.

! All pins on the ZC-4 must be connected! Any pins not directly connected to a switch or relay should be connected to the +V pin.



ZC-4 wiring diagram.

This Diagram shows all 16 possible combinations for the ZC-4 controller when used as a binary controller.

The P2 Jumper must be removed for use with the ZonePRO devices.

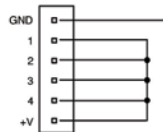
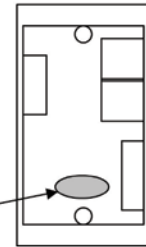

Binary 0

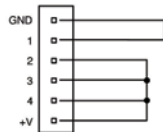

Binary 1

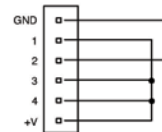

Binary 2

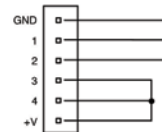

Binary 3

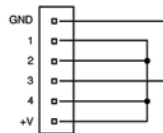

Binary 4

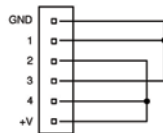

Binary 5

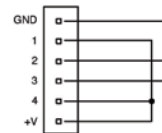

Binary 6

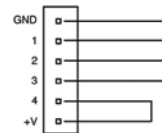

Binary 7

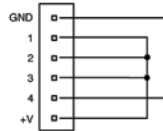

Binary 8

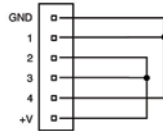

Binary 9

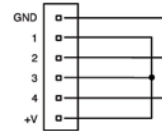

Binary 10

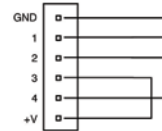

Binary 11

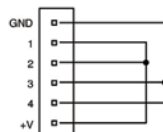

Binary 12

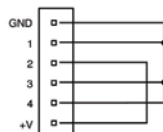

Binary 13



Binary 14



Binary 15

4.4 ZC DIP Switches & Programming

When configuring the ZCs, there are two steps which need to be completed before the ZCs will function:

- Step 1: Assign the ZC IDs and perform the ZC Configuration programming
- Step 2: Associate the ZCs

The programming of the ZCs is performed using the Configuration Wizard in ZonePRO Designer.

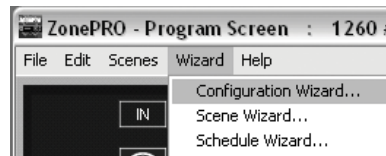

Step 1: Assign the ZC IDs and perform the ZC Configuration programming

The ID# assignments on each Zone Controller, set using the DIP switches on the side of each, must correspond with the appropriate ZC Input port on the back of the ZonePRO device and with the program loaded into the ZonePRO.

Top ZC Input Port (1-6)

The top ZC Input port on the back of the ZonePRO device corresponds with ID#s 1-6. Therefore, to select ID#2 for example, simply flip the 2 DIP switch into the on position and connect the ZC to the top ZC Input port on the ZonePRO. You must then program this ZC, on the corresponding ZC Panel Configuration page in ZonePRO Designer's Configuration Wizard, as ZC Input 2 (ID#2).

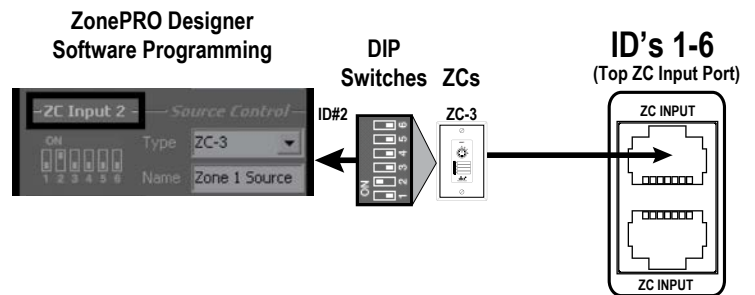

Bottom ZC Input Port (7-12)

The bottom ZC Input port on the back of the ZonePRO device corresponds with ID#s 7-12. The physical DIP switch settings simply start over or repeat when connecting to the bottom ZC Input port on the ZonePRO. For example, to create ID#s 7-12, add 6 to the ID# selected on the ZC's DIP switch. For example, to get an ID# of 10, connect to the bottom ZC Input port and set the ID# to 4 (4+6=10). You must then program this ZC, on the corresponding ZC Panel Configuration page in ZonePRO Designer's Configuration Wizard, as ZC Input 10 (ID#10).

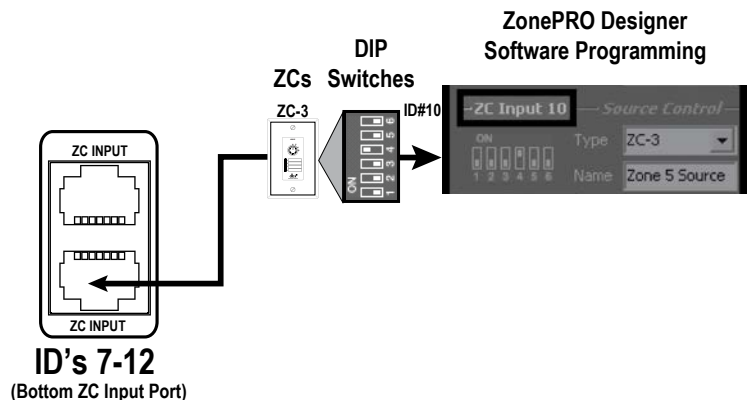

The below diagram shows an example of the DIP switch ID assignments, ZC Input port connections, and ZC Panel Configuration programming for 12 Zone Controllers.

ID #s 1-6 (Top ZC Input Port)

ID #s 7-12 (Bottom ZC Input Port)

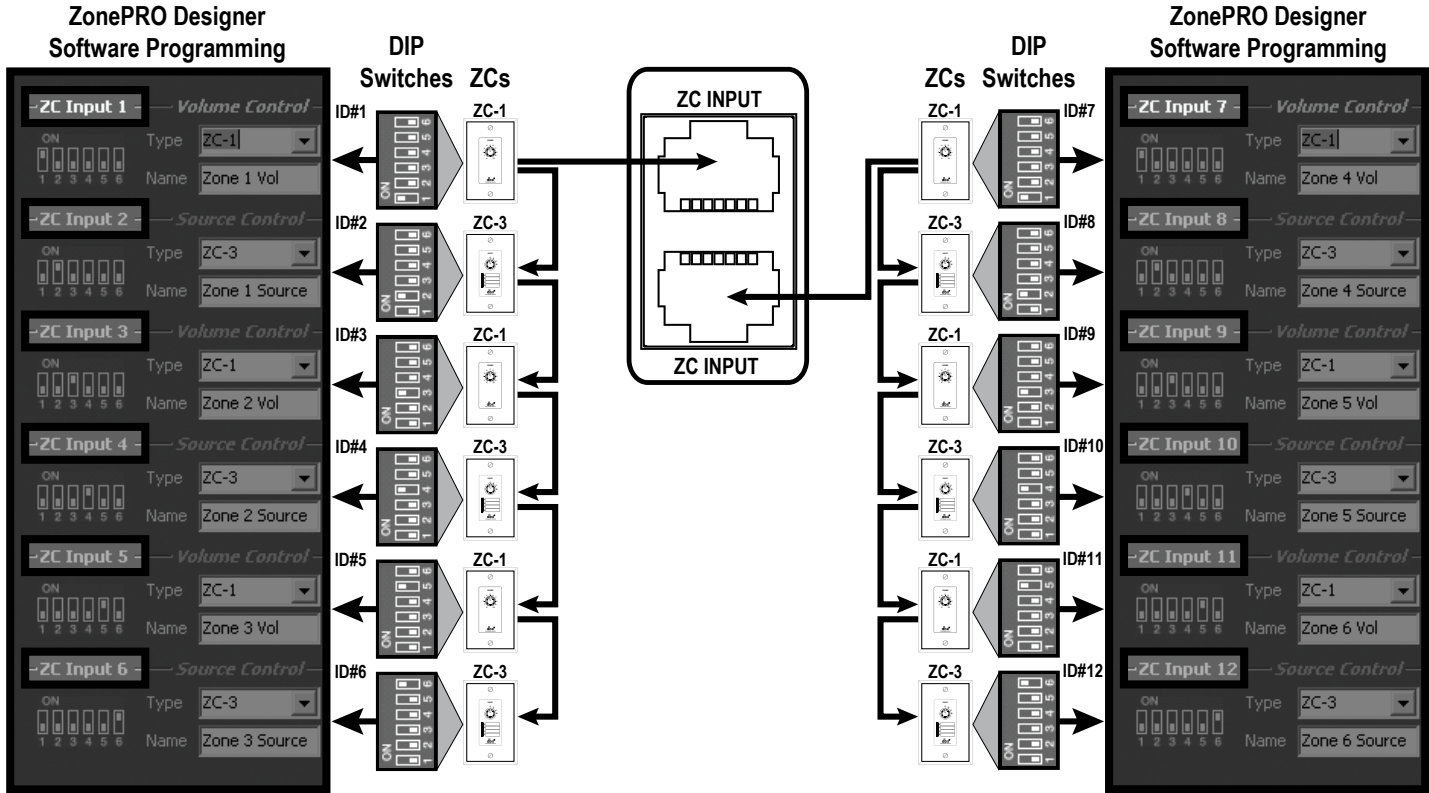

When programming the ZCs on the ZC Panel Configuration page, you will also notice an Edit button next to each assigned ZC.

You will need to click on the Edit button for each assigned ZC to further define how each ZC will function. For example, this is where you would set a volume controller's range constraints (defining how much gain or attenuation the end user is allowed to apply when turning the ZC volume up or down) or assign which input sources will be selected when programming a source selection controller.

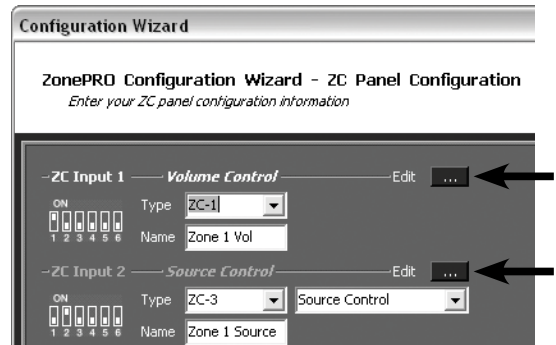

Step 2: Associate the ZCs

The second step in configuring the ZCs is to associate each ZC. In other words, you need to select which input or output is actually being controlled by each ZC. Therefore, you only need to associate volume controllers and source selection controllers; page steering controllers, the ZC-FIRE, and scene selection controllers do not require you to perform this step.

There are two pages in the ZonePRO Designer Configuration Wizard where you associate the Zone Controllers. The first page is the Source ZC Association page. This page simply allows you to associate volume controllers to inputs for controlling input gain. If you wanted to control the volume of a karaoke microphone for example, this is the page where you would associate a ZC volume controller to control the input gain of the karaoke mic.

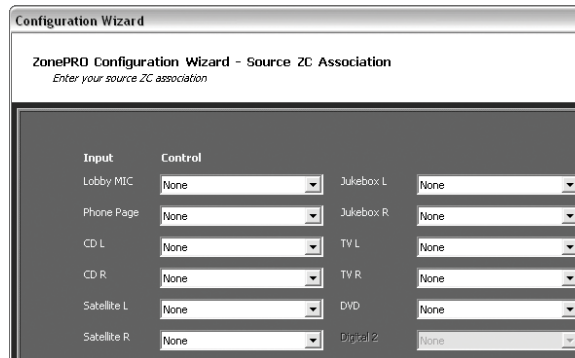

! When controlling input gain, keep in mind that since the gain is performed on the input side of the signal chain, all output zones which the input is routed to will be affected by the gain changes.

The Routing and Zone ZC Association page allows you to associate output zone volume controllers and source selection controllers (this defines which controllers control which zones). The Source column on the left is where the source selection ZCs, such as the ZC-3, are associated. The Level column on the right is where all output zone volume controllers are associated, such as the ZC-1.

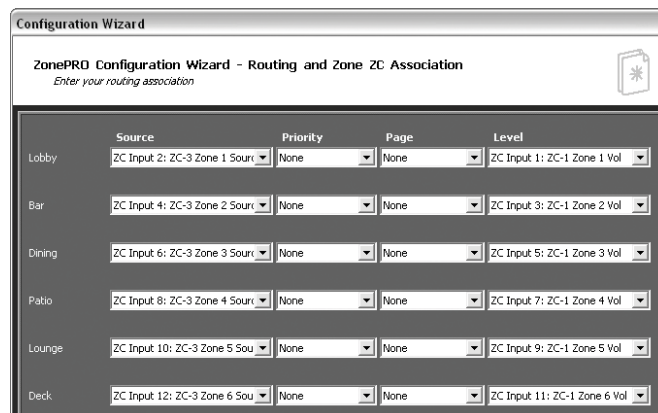

! Please see ZonePRO Designer's help section for further information on these windows.

Section 5 - Link I/O

5.1 Link I/O Overview

The Link Bus allows you to route some of the ZonePRO's audio inputs to another ZonePRO or daisy chain multiple ZonePROs using standard straight-through Cat 5 cables, instead of using "Y" cables or a dedicated distribution amplifier. This allows for easy expansion of outputs (or zones) in a ZonePRO system.

⚠ The Link Bus does not expand the input channel count of a ZonePRO system.

Simply connect a short straight-through Cat 5 cable from the Link Output RJ-45 connector of the device sending the signals, to the Link Input RJ-45 connector of the device receiving the signals.

⚠ The cable length of the linking cable must not exceed 25'. Linking more than 3 ZonePROs is typically not recommended, as systems of this size generally require processors with a more sophisticated feature set.

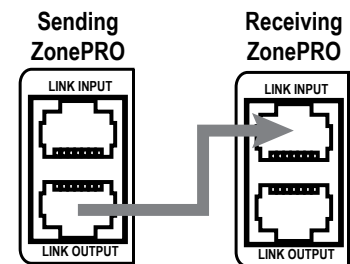

The analog input signals are routed directly to the Link Output connector. Therefore, the program material coming out of the Link Output has not been processed by the DSP and when connected to another ZonePRO's Link Input, both devices are processing the same program material.

The Link Input connector is routed directly to the input circuitry. This means that when using the Link Bus, any inputs sent down the Link Bus and received at a ZonePRO's Link Input will render those corresponding input jacks unusable on the receiving ZonePRO. If a source were to be connected to any of the receiving ZonePRO's corresponding inputs, this would be akin to connecting two sources to the same input jacks and doing so may cause distortion or damage to the processor.

5.2 Jumpers

If there are signals that you do not want to send or receive through the Link Bus you can open those connections in the Cat 5 cable. The RCA inputs are always active and can only be disconnected by opening the connections in the Cat 5 cable, but the ML1 and ML2 Euroblock mic/line inputs do have selection jumpers inside the device. These jumpers can be set to "Enabled" or "Disabled" on the "Link In" side or "Link Out" side on each ZonePRO processor. These jumpers come from the factory set to "Enabled".



CAUTION: These servicing instructions are for use by qualified service personnel only. To reduce the risk of electric shock, do not perform any servicing other than that contained in the operating instructions unless you are qualified to do so. Refer all servicing to qualified service personnel. Disconnect mains power before servicing.



To Enable or Disable the Link Input or Link Output for the ML1 and/or ML2 inputs, match the jumpers to the desired positions.

P12 = ML1
(P18 = ML1 in 640/641)

P13 = ML2
(P16 = ML2 in 640/641)

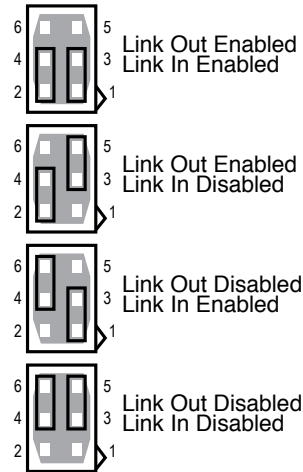
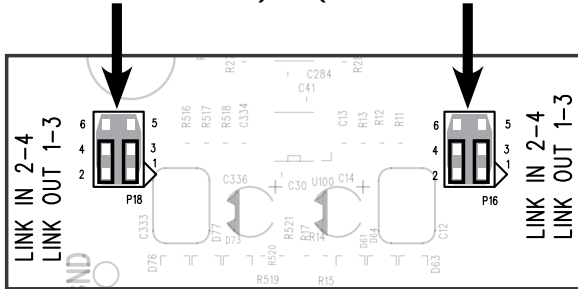

← **Jumper Positions**

The below illustrations highlight which inputs can be sent and received through the Link Bus for each ZonePRO model.

640/64I (Link Bus Send/Receive = MLI, ML2, SI, S2, S3, S4)

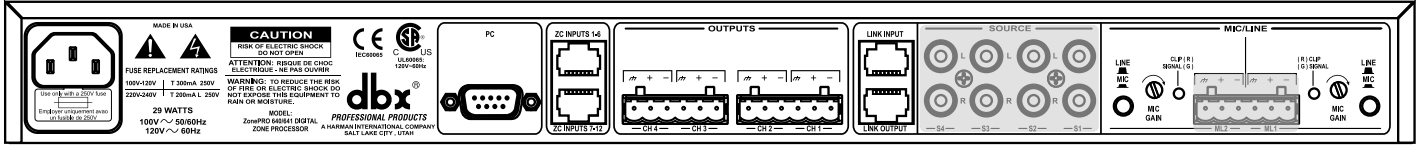

640m/64Im (Link Bus Send/Receive = MLI, ML2, SI, S2)

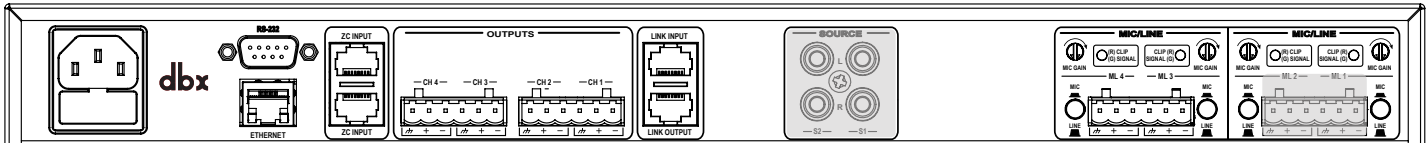

1260/126I (Link Bus Send/Receive = MLI, ML2, SI, S2, S3, S4)

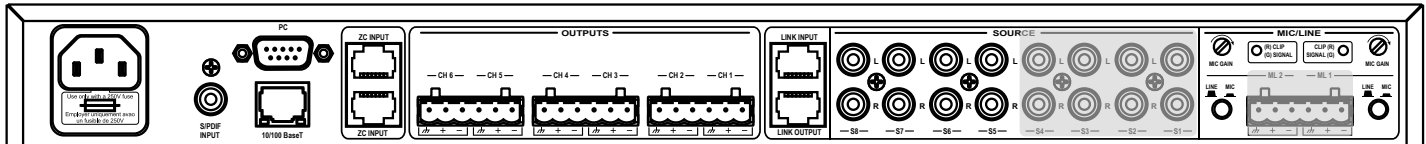

1260m/126Im (Link Bus Send/Receive = MLI, ML2, SI, S2, S3, S4)

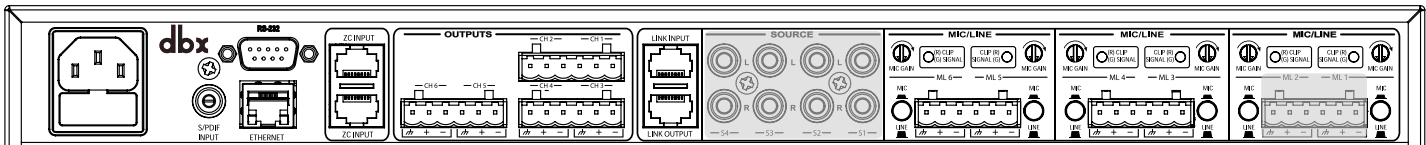

5.3 Link I/O Wiring

Link I/O Cable Specifications: Cat 5 Cable / 4-Twisted Pairs of 24 AWG Wire / 568B Standard

RJ-45 (8-Position)	Color	RJ-45 (8-Position)	Function
1	White / Orange	1	→→ Voltage Reference
2	Orange	2	←← ML1 Input
3	White / Green	3	←← ML2 Input
4	Blue	4	←← S1 Input
5	White / Blue	5	←← S2 Input
6	Green	6	←← S3 Input
7	White / Brown	7	←← S4 Input
8	Brown	8	→→ Ground

Section 6 - Networking

6.1 Default ZonePRO Network Settings

The below table shows the factory default Internet Protocol (IP) settings and ZonePRO Designer Node IDs for the ZonePRO series products.

	640, 641	1260, 1261	640m, 641m	1260m, 1261m
IP Address	N/A	169.254.2.2	169.254.XXX.XXX	169.254.XXX.XXX
Subnet Mask	N/A	255.255.0.0	255.255.0.0	255.255.0.0
Gateway	N/A	0.0.0.0	0.0.0.0	0.0.0.0
ZPD Node ID	48	32	Dynamic	Dynamic

! The ZonePROm processors derive their Node ID and the last two octets of their IP address from the processor's Mac address. This helps prevent IP address and Node ID conflicts when networking multiple ZonePROm processors. The ZonePRO 1260 and 1261 have a static IP address as shown in the above table. Therefore, when networking multiple ZonePRO 1260s or 1261s, their IP addresses must be changed manually in order to avoid IP conflicts.

6.2 Networking Overview

This section provides a step-by-step guide on how to properly connect and configure LAN settings for three different network architectures. The first topology is a simple direct connection using an Ethernet crossover cable. The second method describes how to connect several ZonePROs to an isolated network and configure them with the ZonePRO Designer GUI. The final configuration details how to add one or more ZonePRO devices to an existing Local Area Network (LAN). The following subsections explain how and when to connect to a remote ZonePRO using the proxy feature and some tips and examples of how to access your ZonePRO by setting up a Virtual Private Network (VPN). This section concludes with some further networking considerations and troubleshooting tips that will help with connecting to your ZonePRO device via Ethernet.

Careful planning should be made before placing a ZonePRO on a network that provides any access to the public. Some examples of public access are direct access to the device from the Internet, an unsecured or weakly secured wireless network, a network jack in a public area that provides network access to the ZonePRO, or having a computer on the LAN that is not secured so that someone could use the ZonePRO Designer software to reconfigure the ZonePRO. It is highly recommended that the equipment be placed on a protected, isolated network that does not have any connection to the public to prevent unauthorized users from reconfiguring the device. Please refer to the VPN portion of this section for more information.

At the current time, ZonePROs do not support DHCP or Auto IP (see the previous "Default ZonePRO Network Settings" section for more information). In order to use Ethernet to manage the device from the ZonePRO Designer GUI, modifications to the network settings may be

needed on the PC and/or ZonePRO.

When networking two Ethernet capable devices without a hub or switch, an Ethernet crossover cable must be used; the transmit and receive lines are crossed in an Ethernet crossover cable. If connecting to a hub or switch, you will need to use Ethernet straight-through cables unless your switch/hub supports auto MDI/MDIX.

6.3 Overview of TCP/IP Basics

Subnet

A small network within a larger network. For example, a TCP/IP network might be a subnet of a venue's network, which could include computers throughout the building, or a network might be divided into subnets. For example, in a large installation, there may be one subnet per rack or room.

IP address

An identifier for a computer or device on a TCP/IP network. Each device in a network has its own IP address to identify it. Example: 126.126.17.42. Networks using the TCP/IP protocol route messages based on the IP address of the destination. An IP address consists of four numbers separated by periods. Each number can be zero to 255. The last number should not be a zero or 255. For example, 126.126.17.1 could be an IP address. 126.126.17.0 would not be a valid IP address.

Network ID and Host ID

A TCP/IP or IP address has two parts: the NETWORK ID and the HOST ID. The NETWORK ID identifies the network, and the HOST ID identifies either the subnet and device, or just the device if there is no subnet.

The subnet mask is a code that indicates which part of the TCP/IP address is the NETWORK ID and which part is the HOST ID. In subnet-mask code, 255 means "This part of the address is the NETWORK ID".

Example: Suppose the IP ADDRESS of a device is 192.168.12.34 and the SUBNET MASK is 255.255.0.0. That means, (192.168) is the NETWORK ID. The remaining set of numbers (12.34) is the HOST ID. If your network stands alone (it is not part of a larger network) then the HOST ID identifies each device in the network. If your network is part of a venue's larger network, your network is actually a sub-network or subnet.

All devices in the network have the same network ID. There are many resources available on the Internet for IP and subnet calculation.

DHCP (Dynamic Host Configuration Protocol)

This is a protocol for automatically assigning IP addresses to devices on a network. With dynamic (DHCP) addressing, a device might have a different IP address every time it connects to the network. If a computer is NOT connected to a network with a DHCP server, the computer will assign a default network ID into the TCP/IP address and a default subnet mask. In this case the attached computer may need its IP address

assigned statically (manually). Please note, at this time, ZonePROs do not support DHCP.

6.4 Connecting via direct-connect Ethernet

Assumptions:

- Using Microsoft Windows XP, Vista, or 7.
- Computer has a working Ethernet network adapter.
- You have administrative rights on the PC so that network settings can be changed if necessary.

1. Connect an Ethernet crossover cable to both the ZonePRO and the PC.

! A standard straight-through Ethernet cable will not work in this direct connect situation with a 1260 or 1261 because common straight-through cables are designed to hook a device to a hub or switch. See section “8.8 Wiring Diagrams” for a wiring diagram of the Ethernet crossover cable.

2. Apply power to the ZonePRO and wait for it to boot.
3. Windows networking, in its default configuration, will automatically configure its IP setting to something in the Auto-IP range (169.254.xxx.yyy with a subnet mask of 255.255.0.0 and no gateway). The process of windows assigning an Auto-IP address normally takes 1-2 minutes.
4. **Optional** (You only need to do these steps if the ZonePRO device does not show up in step 7.) Verify that you have the correct IP settings on your computer by running ipconfig.
 - a. This is done by clicking on “**Run**”... from the Window’s Start Menu.
 - b. Enter cmd and click “**OK**”. This will bring up a command window (DOS box).
 - c. At the prompt, enter ipconfig and press enter.
 - d. Now on your screen you will see your current IP settings. You should notice that the IP Address for the adapter will either be 169.254.x.y where x and y are numbers between 0 and 255, or 0.0.0.0. If it is 0.0.0.0, wait for about a minute and enter the ipconfig command again (Windows is still trying to obtain an IP address). It takes Windows about 1-2 minutes to set an Auto-IP address. If you have some other address, you are either not hooked directly to the ZonePRO with the crossover Ethernet cable, or your computer is configured with a static IP address.

Only perform these next steps if your computer is configured with a static IP address (i.e. your IP address is not 169.254.x.y or 0.0.0.0). Otherwise skip to step 5.

- a. From the control panel, open the network connections window.
- b. Right click on the Local Area Network (LAN) connection that is wired to the ZonePRO and select “Properties”.
- c. Highlight “Internet Protocol (TCP/IP)” and then press the properties button.
- d. If “Use the following IP address” is selected, write down all the information on this page. The following steps will overwrite these settings, so you will need to keep this information to restore your network settings.
- e. Select the “Obtain an IP address automatically” radio button.

- f. Click on the Alternate Configuration tab and make sure that “Automatic private IP address” is selected.
 - g. Click OK in each window to close them.
 - h. After about 1-2 minutes your computer will configure itself with the correct IP settings. Verify this by running the ipconfig command again, as described above.
5. Launch the ZonePRO Designer application. If it is currently running, make sure that you are not online by selecting “Go Offline” from the Network menu. If the device icon is already grayed-out, ZonePRO Designer is currently offline.
6. Select “Properties” from the Network menu. Make sure that “Use Ethernet” is selected. Click “Next”.
7. Click “Next” again to enter the Address Tool. Ensure that there are no addressing conflicts (only ZonePRO Designer and the ZonePRO device should show up, and their Node addresses should already be different). Close the Networking Wizard.
8. Select “Go Online” from the Network menu. A ZonePRO icon will appear in the main ZonePRO Designer window. This indicates that you are online and the ZonePRO Designer software has discovered the ZonePRO device.

6.5 Setup of a simple isolated Ethernet network

Assumptions:

- Using Microsoft Windows XP, Vista, or 7.
 - Computer has a working Ethernet network adapter.
 - You have an Ethernet hub (or switch) and Ethernet cables for each connection needed. An integrated device such as a home gateway/router will not work because they have a DHCP server (see section 6.3).
 - You have administrative rights on the PC so that network settings can be changed if needed.
 - The Ethernet network consists of exactly one computer that will be used to run the ZonePRO Designer software and one or more ZonePRO devices.
1. Connect the PC and any ZonePRO devices to the hub using standard straight-through Ethernet cables.
 2. Apply power to all ZonePRO devices and wait for them to boot.
 3. Windows networking, in its default configuration, will automatically configure its IP setting to something in the Auto-IP range (169.254.xxx.yyy with a subnet mask of 255.255.0.0 and no gateway). This process normally takes 1-2 minutes.
 4. **Optional** (You only need to do these steps if the ZonePRO device does not show up in step 7.) Verify that you have the correct IP settings on your computer by running ipconfig.
 - a. This is done by clicking on “Run”... from the Window’s Start Menu.
 - b. Enter cmd and click “OK”. This will bring up a command window (DOS box).

- c. At the prompt, enter `ipconfig` and press enter.
- d. Now on your screen you will see your current IP settings. You should notice that the IP Address for the adapter will either be 169.254.x.y where x and y are numbers between 0 and 255, or 0.0.0.0. If it is 0.0.0.0, wait for about a minute and enter the `ipconfig` command again (Windows is still trying to obtain an IP address). It takes Windows about 1-2 minutes to set an Auto-IP address. If your computer has an IP address not beginning with "169.254", your computer is configured with a static IP address.

Only perform these next steps if your computer is configured with a static IP address. (i.e. your IP address is not 169.254.x.y or 0.0.0.0.) Otherwise skip to step 5.

- a. From the control panel, open the network connections window.
 - b. Right click on the Local Area Network (LAN) connection that is wired to the ZonePRO and select "Properties".
 - c. Highlight "Internet Protocol (TCP/IP)" and then press the properties button.
 - d. If "Use the following IP address" is selected, write down all the information on this page. The following steps will overwrite these settings, so you will need to keep this information to restore your network settings.
 - e. Select the "Obtain an IP address automatically" radio button.
 - f. Click on the Alternate Configuration tab and make sure that "Automatic private IP address" is selected.
 - g. Click OK in each window to close them.
 - h. After about 1-2 minutes your computer will configure itself with the correct IP settings. Verify this by running the `ipconfig` command again, as described above.
5. Launch the ZonePRO Designer application. If it is currently running, make sure that you are not online by selecting "**Go Offline**" from the Network menu. If the device icon is already grayed-out, ZonePRO Designer is currently offline.
 6. Select "**Properties**" from the Network menu. Make sure that "**Use Ethernet**" is selected, and that the "**Proxies**" list is empty. Click "**Next**".
 7. Click "**Next**" again to enter the address tool. Ensure that there are no addressing conflicts. If this is the first time you are connecting to some of your ZonePRO devices, you will need to resolve network conflicts. Each ZonePRO device must have a distinct IP address and Node address. When all conflicts are resolved, close the Networking Wizard.
 8. Select "**Go Online**" from the Network menu. A ZonePRO icon will appear in the main ZonePRO Designer window. This indicates that you are online and the ZonePRO Designer software has discovered the ZonePRO device.

6.6 Adding the ZonePRO to an existing Local Area Network

Assumptions:

- Using Microsoft Windows XP, Vista, or 7.
 - Computer has a working Ethernet network adapter.
 - You have a static IP address that is compatible with your existing network.
 - There is an existing LAN where the computer that will be running the ZonePRO Designer software is able to attach to the LAN, obtain an IP address, and see other devices on this network.
1. Connect the ZonePRO device to the network using a standard straight-through Ethernet cable.
 2. Apply power to the ZonePRO device and wait for it to boot.
 3. Launch the ZonePRO Designer application. If it is currently running, make sure that you are not online by selecting **“Go Offline”** from the Network menu. If it is already grayed-out, ZonePRO Designer is currently offline.
 4. Select **“Properties”** from the Network menu. Make sure that **“Use Ethernet”** is selected. Click **“Next”**.
 5. Click **“Next”** again to enter the Address Tool. It may take up to one minute for your new ZonePRO to show up in the device window.
 6. Select the ZonePRO from the table and click **“Change Address”** to set the IP address of your ZonePRO device. Contact your network administrator for IP address, subnet mask, and default gateway settings that are appropriate for your network. If connecting multiple ZonePRO devices, ensure that there are no addressing conflicts. If you see more than one ZonePRO device, you may need to resolve network conflicts. Each ZonePRO device must have a distinct IP address and Node address. When this is done and all network conflicts are resolved, close the Networking Wizard and the ZonePRO Designer application.
 7. Launch the ZonePRO Designer application and select **“Go Online”** from the Network menu. The ZonePRO icon(s) should appear in the main ZonePRO Designer window. This indicates that you are online and the ZonePRO Designer software has discovered the ZonePRO device(s).

6.7 Proxy

The proxy feature allows you to access a ZonePRO over a complex or remote network. An example of this is when the PC and the ZonePRO reside on different subnets. The mechanism that is used by default for the ZonePRO designer software to discover and maintain a connection to the ZonePRO devices utilizes IP broadcast packets. These packets will not travel through internet routers and even some high end core switches. In order to connect to one or more ZonePROs that are attached to a complex network, proxy is used to tell the ZonePRO Designer software where on the network to look for the ZonePRO devices.

! There only needs to be one proxy setup for each group of ZonePROs that are on the same local network. The device that is the proxy will pass information to the other ZonePROs that it sees on the network that will allow them to connect to the ZonePRO Designer software.

Follow these steps to setup a proxy connection:

1. Make sure that the ZonePRO has been correctly configured for the network that it is on and that the PC that is running the ZonePRO Designer software has a network connection to that ZonePRO device. You should be able to ping the ZonePRO from the Windows computer.
2. Select **“Properties”** from the Network menu of the main ZonePRO Designer window.
3. Make sure that **“Use Ethernet”** is selected.
4. Select **“Advanced”**.
5. Click the **“Add”** button. The Add Proxy window will appear.
6. Enter the IP address or a host name for one of the ZonePRO devices on the remote network and click **“OK”**.
7. Press the **“Finish”** button to close the properties window.
8. Select **“Go Online”** from the Network menu. After a moment you will see your devices appear in the main ZonePRO Designer window. This indicates that you are online and the ZonePRO Designer software has discovered the ZonePRO devices.

If the ZonePRO Designer software can not establish a connection with the proxy you will receive a failure message after about one minute of trying to connect.

Proxy can be used to allow remote access to monitor and make minor changes to any ZonePRO that is accessible from the internet. There are some things that can not be done over a proxy connection. For example, it is not possible for you to change the IP or Node addresses over a proxy connection. Proxy is not intended for initial setup of any ZonePRO, it can only be used for remote monitoring and minor maintenance.

6.8 Virtual Private Networks (VPN)

Virtual private networks (VPNs) provide an encrypted connection (or tunnel) between networks or between a network and a user over a public network (such as the Internet). Instead of using a dedicated, real-world connection such as a leased line, a VPN uses virtual connections through the public network. The advantage of a VPN is that your computer can be virtually connected to a local network from anywhere in the world where you have an internet connection. This can also be done in a safe manner, not compromising your local network's security. If you would like to manage your ZonePROs remotely you should create a secure VPN connection.

There are many solutions on the market today that provide VPN access. These products offer different features, methods of VPN, complexity of setup and maintenance, as well as varying levels of security. Recommending a VPN solution that will best suit the needs of your network is beyond the scope of this document, although you will need a VPN that is capable of passing UDP and TCP traffic (most do). The ZonePRO has been tested against several solutions and should work with all VPNs that meet these criteria. Please work with your system administrator and Internet service provider to find a VPN that will best fit your network.

The 3Com OfficeConnect Secure Router (model # 3CR860-95) is one solution that has been tested, and is both inexpensive and simple to set up. It provides up to two concurrent VPN connections. It works well with the built-in VPN interfaces in Microsoft Windows 2000 and XP.

6.9 Network Considerations and Limitations

- Without a VPN, there can be no access from the outside world to any ZonePRO that is behind a Network Address Translation (NAT) router. (One-to-One NAT and port forwarding will not work.)
- The Address Tool will not allow address changes on any ZonePRO that is connected to the GUI via a proxy.
- When connecting to a ZonePRO through a proxy, the Locate Tool will only work on the device that is setup as the proxy, and not the devices that are connected through it.
- Only connect at a 10-Mbit rate. This will work at both 10 half and 10 full duplex. Any device that is forced to 100-Mbit or above will not link up.
- There is no auto sensing of the Ethernet Tx/Rx pairs. This means that if a hub switch is not used, then the user must connect to the device via an Ethernet crossover cable.
- There is a maximum of 10 ZonePRO devices that can connect to the ZonePRO designer software at any given time.
- If the proxy link initially fails to connect, the user must go offline and then go back online before the proxy connection will be re-established.
- Firewall Considerations: The ZonePRO uses port 3804 (udp and tcp) to communicate with the ZonePRO Designer software. Make sure that you configure your firewalls correctly so that data sent to and from this port number can traverse your network.

6.10 Network Troubleshooting

If you are having difficulty getting your ZonePRO to show up in your ZonePRO Designer software, here are some things that you can try to resolve the problem.

Software Firewall: If the PC that you have installed the ZonePRO Designer software on has a built in firewall, you need to make sure that you allow the software the ability to communicate on your network. Try disabling your firewall and then going offline and back online in the ZonePRO software. If this fixes the problem, refer to your firewall manufacturer's documentation on how to reconfigure your firewall to allow the ZonePRO Designer application and/or port 3804 tcp and udp to pass through the firewall.

Ethernet Link: Make sure that you have a valid Ethernet connection by looking at the link status LEDs on each device's Ethernet port. Most Ethernet devices will have some kind of indicator that shows the link is present. Check the following connections:

- ZonePRO device – If there is a valid connection on the ZonePRO you will see a solid green LED.
- PC running the ZonePRO Designer software
- Hub/Switch (if used)
- If you fail to see a link light, try removing and reinserting the cable or try a different, known-working cable. Also, make sure you are using the correct type of Ethernet cable.

Ping: There is a simple utility built into Microsoft Windows operating systems that test the network connection between two devices. The following steps outline how to use this utility.

1. Click the **Windows Start Menu** button then select **Run**.
2. Enter **cmd** and press **OK**. This will bring up a command window.
3. In the command prompt window, enter **PING <IP address of your ZonePRO>** (example: ping 169.254.10.10) and press the **Enter** key. The data should appear something like this:

Pinging 10.10.10.1 with 32 bytes of data:

Reply from <IP address of your ZonePRO>: bytes=32 time<1ms TTL=64

Reply from <IP address of your ZonePRO>: bytes=32 time<1ms TTL=64

Reply from <IP address of your ZonePRO>: bytes=32 time<1ms TTL=64

Reply from <IP address of your ZonePRO>: bytes=32 time<1ms TTL=64

If you get a "reply from" response from the IP address that you were pinging in a timely manner, it means that you have a valid network connection between the two devices.

If you receive a "**Destination net unreachable**" or "**Request timed out**" message, this indicates that your computer is not communicating with the ZonePRO device.

Section 7 - Application Guide

7.1 Restaurant Application

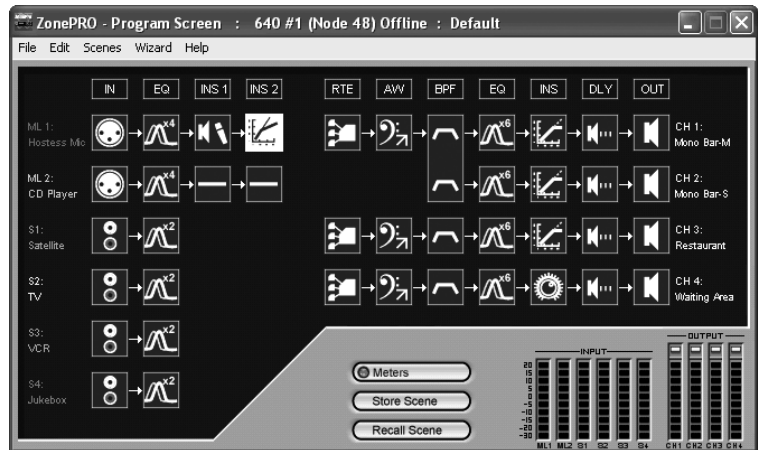
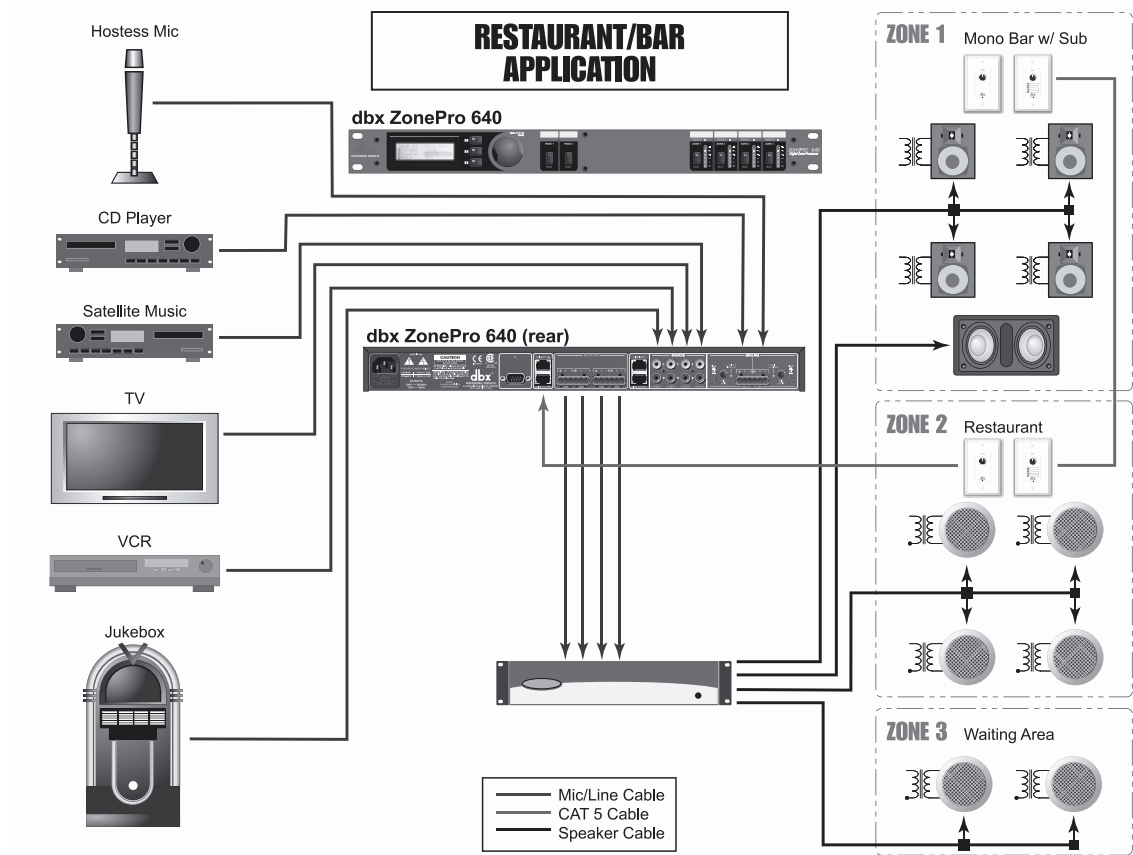

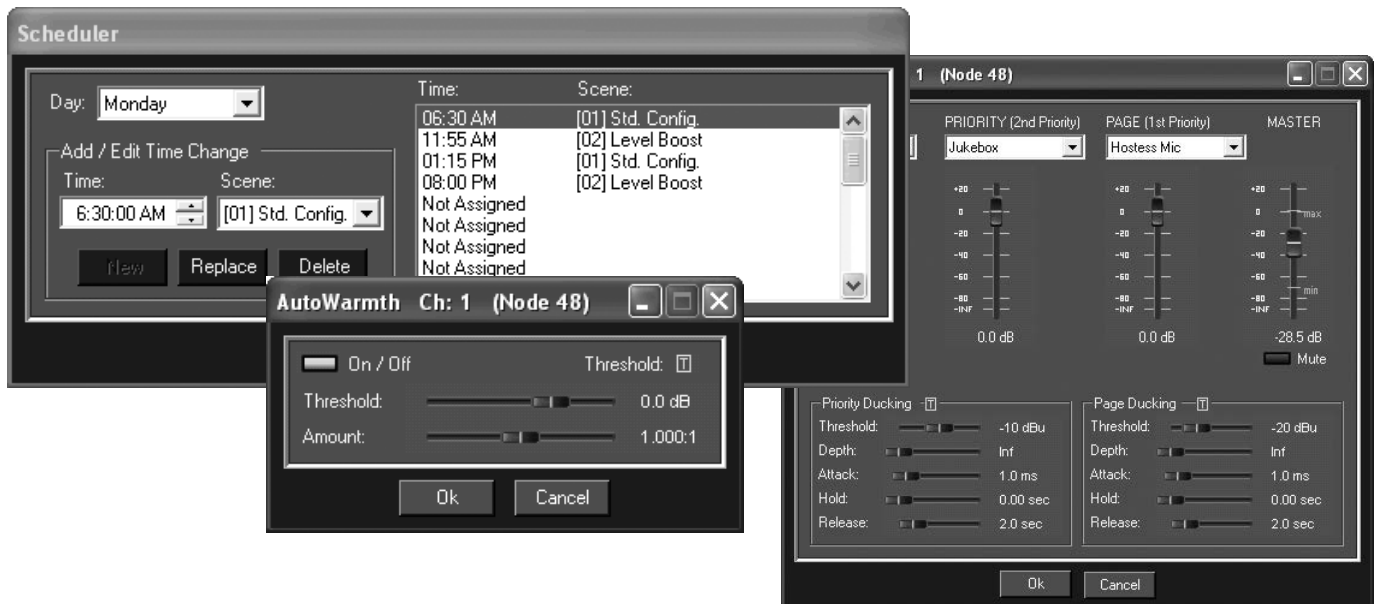

Notes - Restaurant/Bar Application

1. The ZonePRO 640 device is located in the manager's office and provides front panel source selection for the waiting area.
2. Both the restaurant and the bar area have ZC controllers. The bar is using them for source selection (ZC-3) and volume control (ZC-1). The ZC-1 in the restaurant is used for volume control, and the ZC-3 is used for scene changes.
3. Paging is done from the hostess station and is pre-assigned to the bar and the waiting area.
4. The Zone Controllers for the bar and restaurant are wired with Cat 5 cable in series with the bar ZC-3 and ZC-1 as ID#2 and #3, and the restaurant ZC-3 and ZC-1 as ID#1 and #4.
5. Scenes have been created that accommodate changes in the venue such as a volume boost in the bar for happy hour as well as the regular volume boost in the restaurant for the lunch time rush and the dinner crowd.
6. The ZC-3 in the restaurant is used to change between scenes as needed.
7. The Schedule function has been used to load the restaurant "Level Boost" scene automatically at the beginning of the lunch and dinner periods.
8. EQ, Feedback Suppression, and Compression are used on the hostess mic to help improve intelligibility and reduce unwanted feedback in the system.
9. Limiting is used in the bar area to provide system protection.
10. AutoWarmth® is engaged in the bar and restaurant to maintain the bandwidth even when the level drops, while Auto Gain Control is being used in the waiting area to maintain the signal level.
11. Output EQ is used in all zones to make the system sound as good as possible.

7.2 Health Club Application

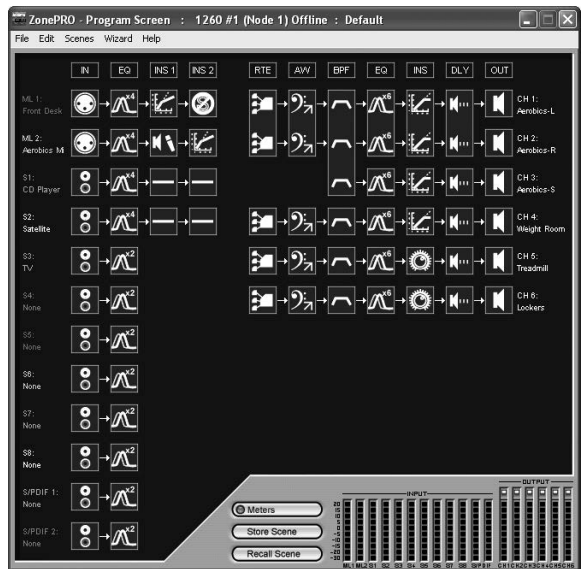
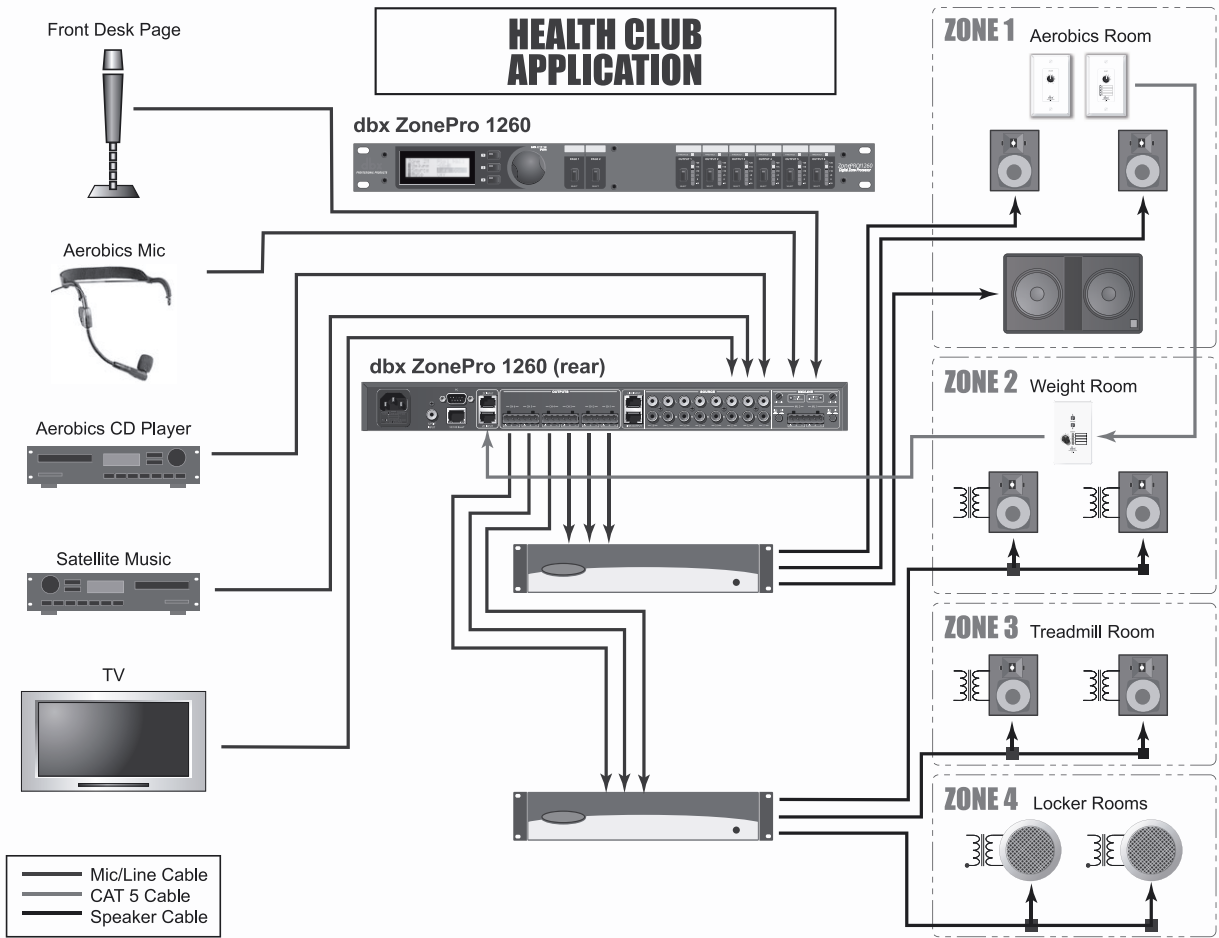

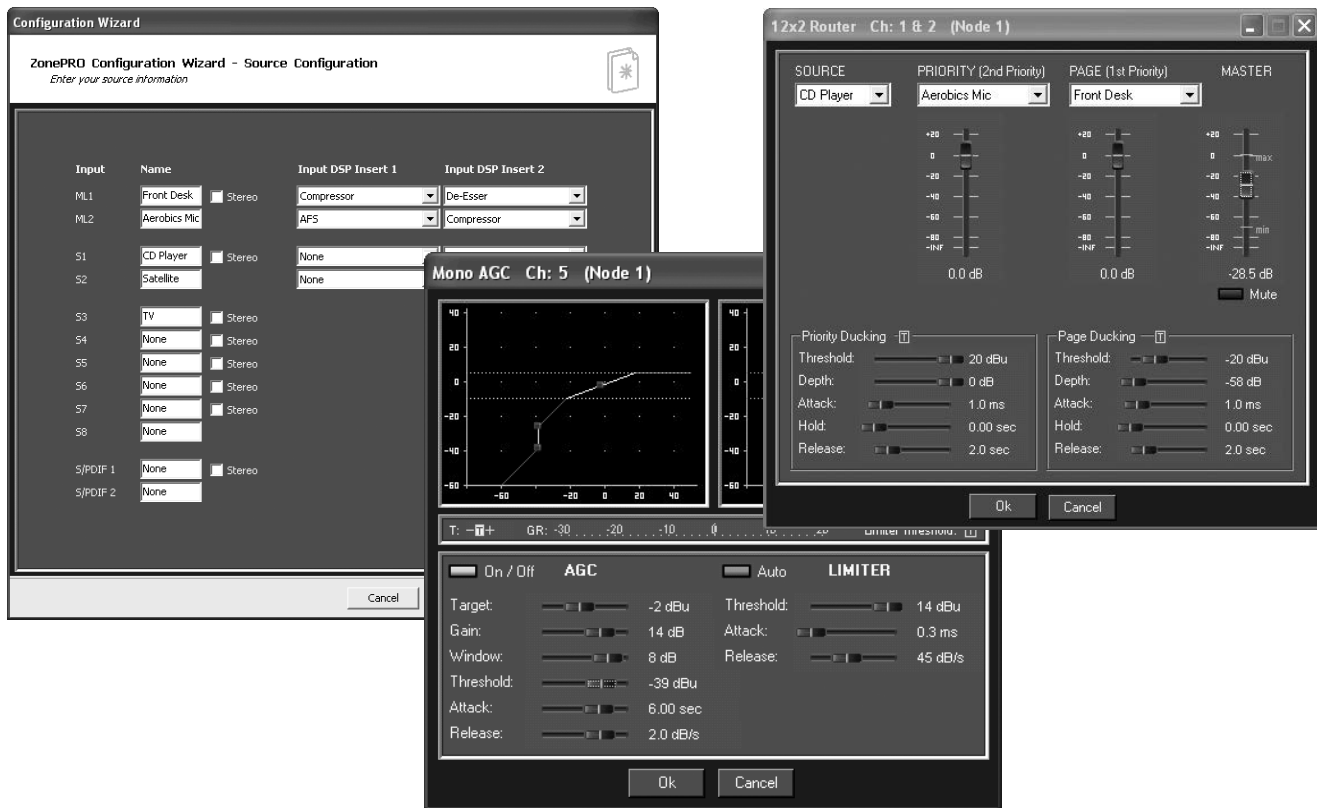

Notes - Health Club Application

1. The ZonePRO 1260 device is located near the front desk area.
2. ZCs in the weight room and the aerobics room allow source selection and volume control.
3. The aerobics instructor's microphone is routed only to the aerobics area as the Priority source and is simply mixed in as the priority source rather than ducking the primary source.
4. Feedback Suppression, Compression, and EQ are used on the aerobics microphone to help improve intelligibility and reduce unwanted feedback in the system.
5. Compression, De-Essing, and EQ are used to make the paging microphone as intelligible as possible.
6. The Crossover is used to separate the frequencies for the main and sub speakers in the aerobics room.
7. The TV feed comes from the treadmill room and is the priority source for that area, overriding the primary source. Whenever the TV is on, its audio is routed to the treadmill room and it can also be selected in the weight room.
8. The locker rooms always have the Satellite Music selected as their primary source and receive paging from the front desk.
9. Automatic Gain Control is used in the treadmill room and locker rooms to keep the level consistent.
10. Output EQ is used in all zones to make the system sound as good as possible.

7.3 Nightclub Application

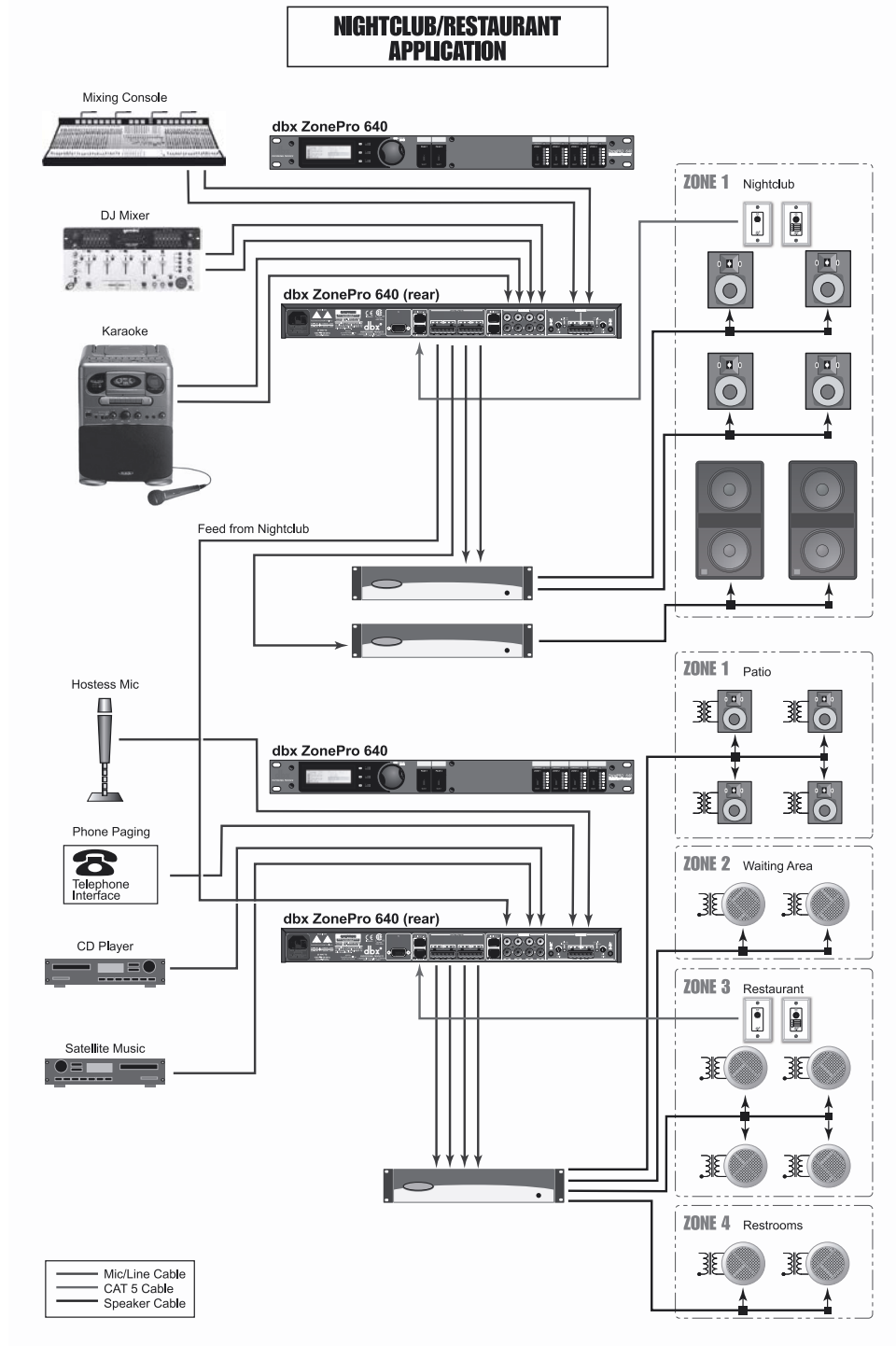

Notes - Nightclub Application

1. The ZonePRO 640 devices are located in the manager's office.
2. The ZCs in the nightclub are situated near the bar and allow source selection and volume control.
3. The Cossover is used to separate the frequencies for the main and sub speakers in the nightclub.
4. Output Delay is used to delay the signal from the nightclub area so it arrives at the same time as the acoustic signal from the nightclub.
5. The restaurant receives the signal from the nightclub allowing it to be sent to the entire restaurant.
6. The zone controllers in the restaurant provide source selection for the restaurant, patio, waiting area, and restrooms, and volume control over the restaurant zone.
7. Automatic Gain Control is used in the patio, waiting area, and restrooms to keep the level of each zone consistent.
8. Output EQ is used in all zones to make the system sound as good as possible.

Section 8 - Appendix

8.1 ZonePRO 640/641 Block Diagram

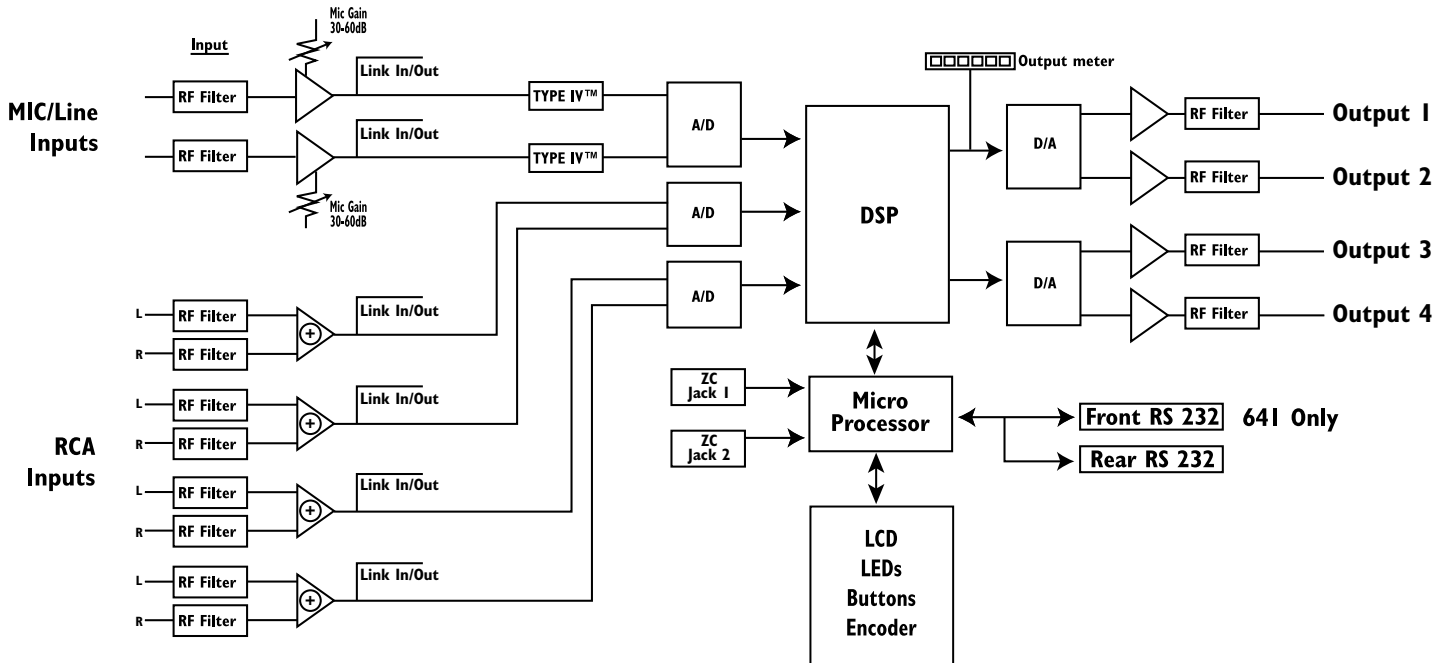

8.2 ZonePRO 640m/641m Block Diagram

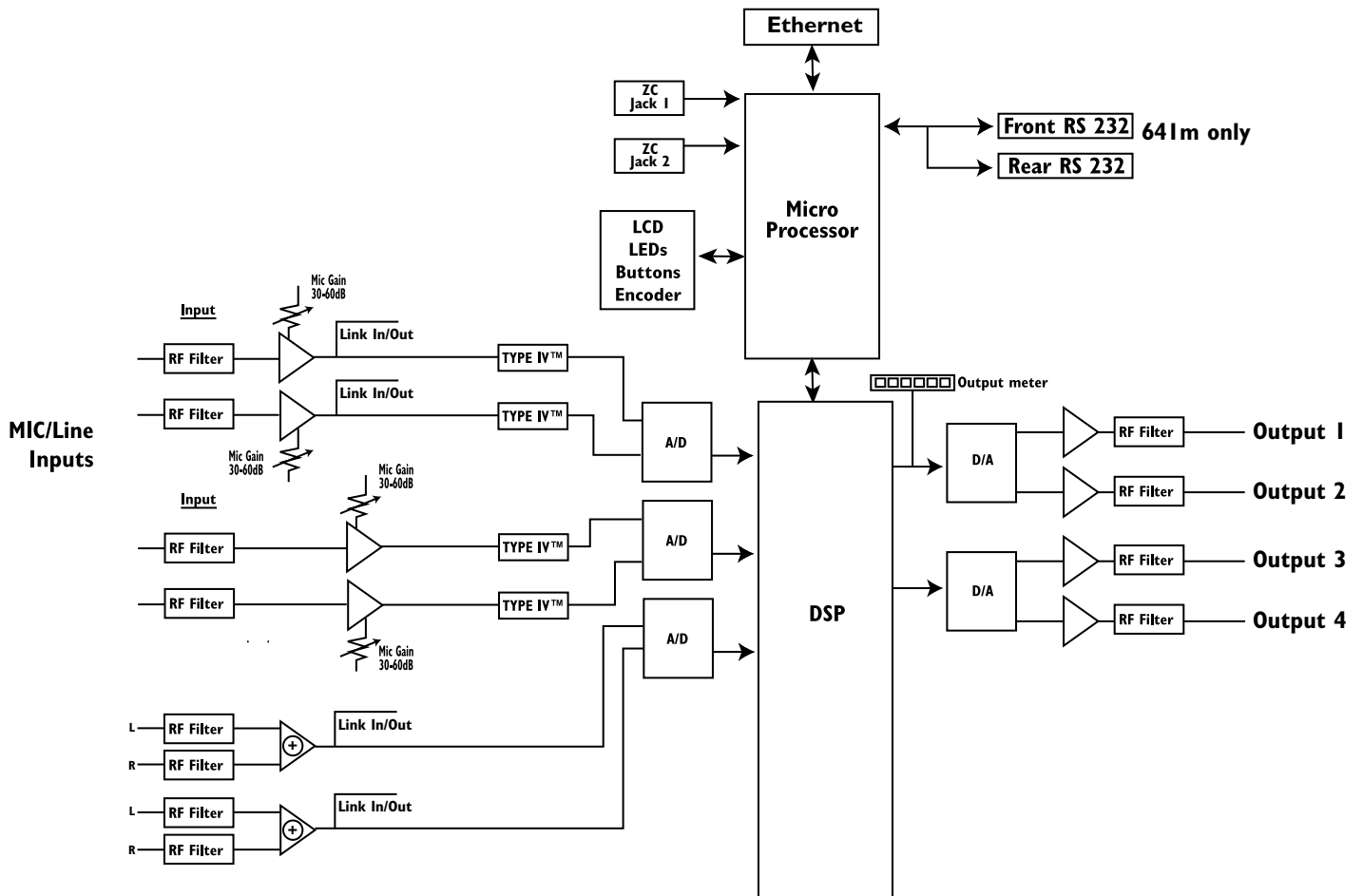

8.3 ZonePRO 1260/1261 Block Diagram

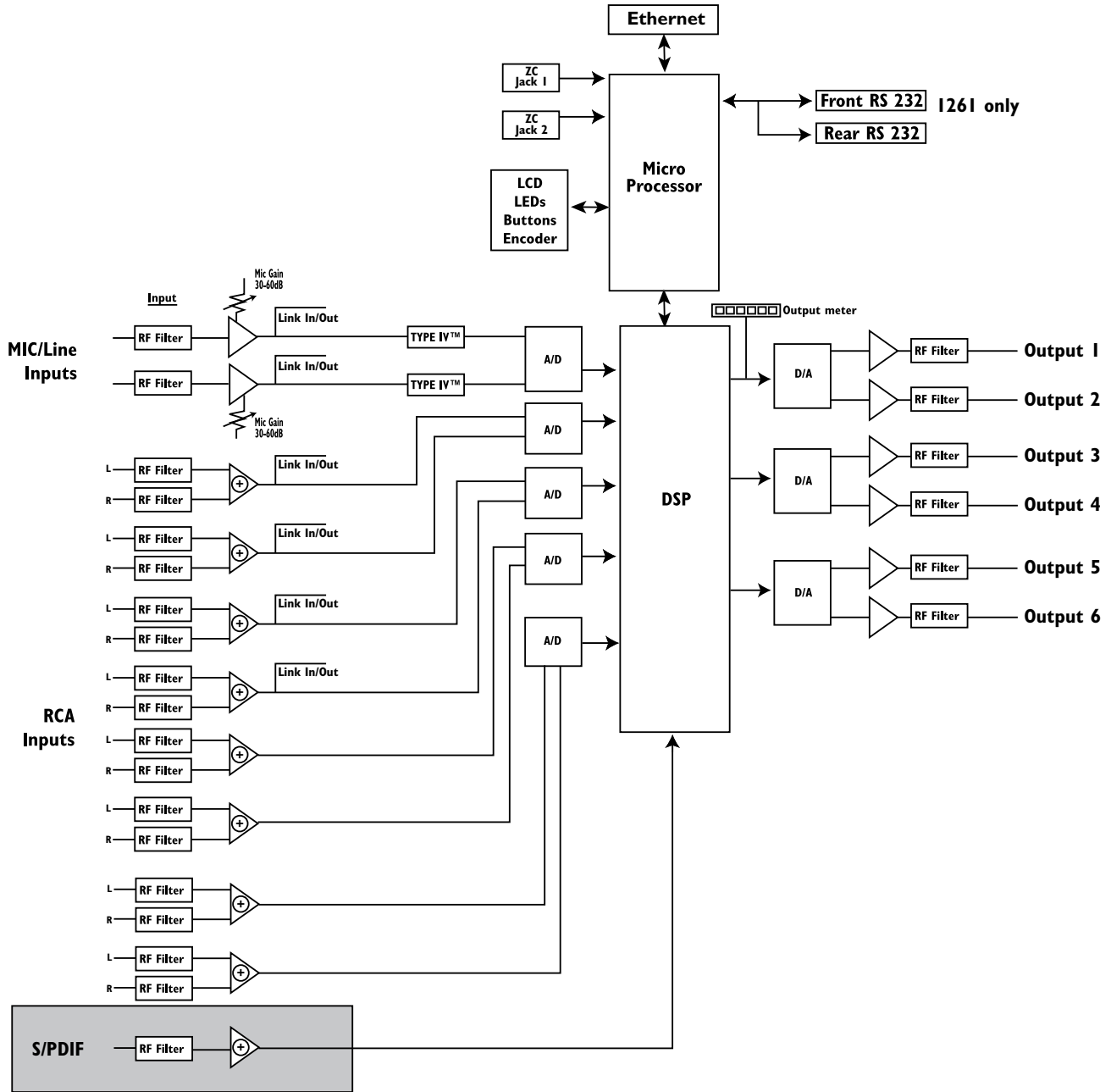

8.4 ZonePRO 1260m/1261m Block Diagram

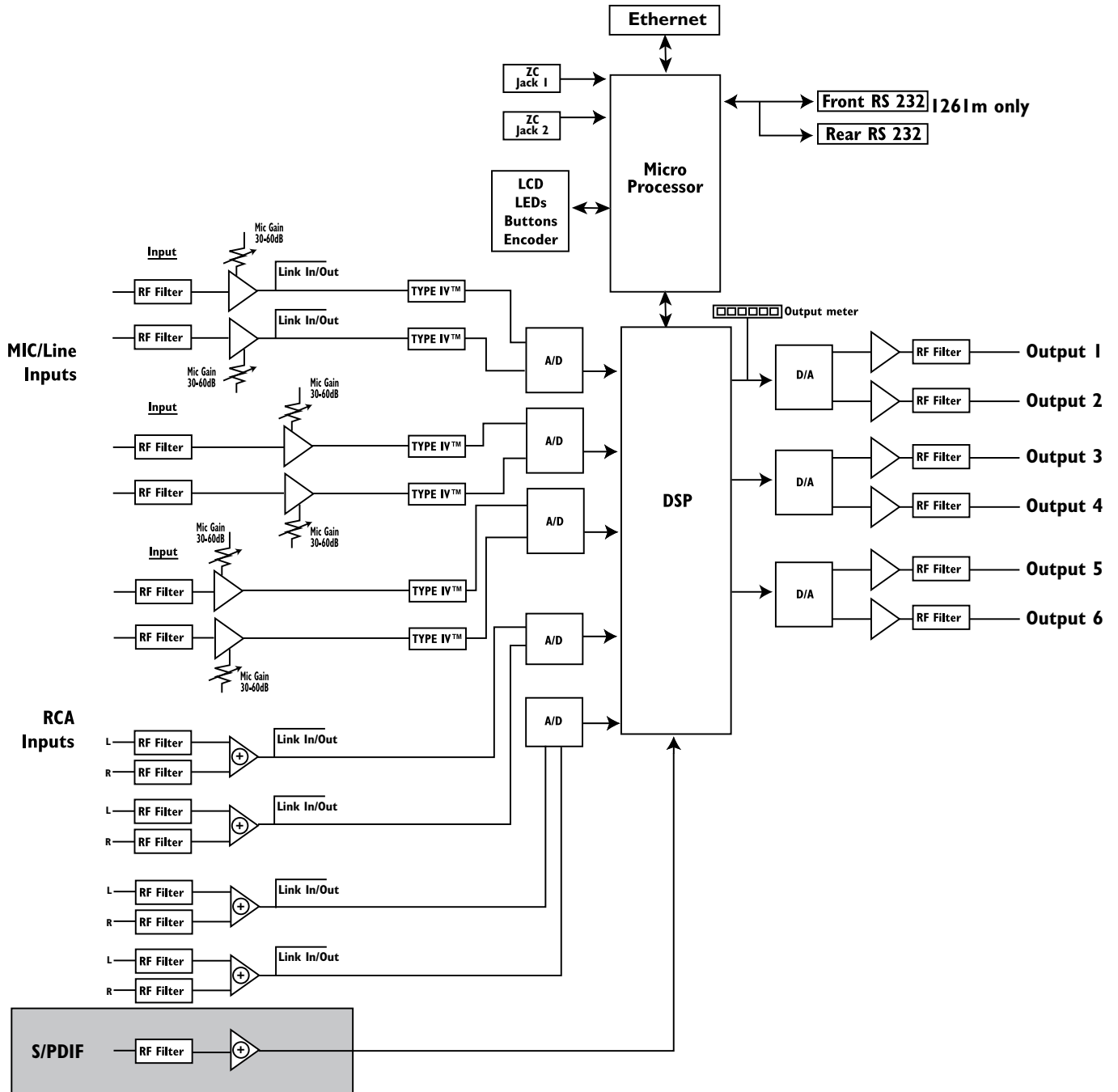

8.5 Firmware Updates

Flash Update (1260, 1260m, 640, 640m)

A ZonePRO firmware release will include a PC application that will load the new firmware version to a device connected via RS232. The receiving ZonePRO should be running. Follow the directions in the PC flasher application.

If, for some reason, you are not able to update your firmware successfully using this method, there is another “backdoor” method. This method forces the ZonePRO into a special Flash Update Receive Mode:

Hold the <1> button while connecting power to the ZonePRO. A message similar to the following will appear:

```
WAITING FOR  
FLASH DOWNLOAD
```

```
2B100002
```

The device now accepts a flash download from the PC flasher application. Run the PC flasher application then follow the instructions on the LCD when the flash completes.

Flash Update (1261, 1261m, 641, 641m)

A ZonePRO firmware release will include a PC application that will load the new firmware version to a device connected via RS232. The receiving ZonePRO should be running. Follow the directions in the PC flasher application.

If, for some reason, you are not able to update your firmware successfully using this method, there is another “backdoor” method. This method forces the ZonePRO into a special Flash Update Receive Mode:

In the “Help” tab of the program dialog of ZonePRO Designer select 641/1261 Operation > Flash Start. Close ZonePRO Designer and open the PC flasher application. Follow the directions in the PC flasher application. Disconnect and then reconnect the power to the 1261 when the flash is complete.

8.6 Factory Reset Procedures

In the event that a reset is required, the ZonePRO offers you the option of performing a “Hard” or “Soft” Factory Reset.

The results of performing a “Soft” reset are:

- The state of the currently loaded scene’s parameters are reset to what has been stored in flash for that scene (this invalidates the state of those parameters when the device was last turned off).
- The currently loaded scene is reset to Scene 1.

The results of performing a “Hard” reset are:

- A “Soft” reset is performed.
- The Node Address for the device is reset back to the factory default.
- The DHCP flag for the device is reset to 0.
- The IP Address for the device is reset to the factory default.
- The IP Subnet Address for the device is reset to 255.255.0.0.
- The IP Gateway Address for the device is reset to 0.0.0.0.
- The “Fire” state of the device is reset to UNARMED.
- The entire User Flash Memory is erased and initialized to contain the Factory Default Configuration and the Factory Default Scene 1.
- Real Time Clock schedule reset (nothing scheduled) and stored to User Flash Memory.

**Factory “Soft” Reset From the Front Panel
(1260, 1260m, 640, 640m)**

Press and hold the <3> button on power-up until the following message appears in the display:

```
! SOFT RESET?  
Yes  <UTILITY>  
No   <PAGE2>
```

To activate a “Soft” Reset, press the <UTILITY> Button. Pressing any button other than <UTILITY> will abort the “Soft” Reset and cause the device to boot normally.

**Factory “Soft” Reset From ZonePRO Designer
(1261, 1261m, 641, 641m)**

From ZonePRO Designer’s program screen, select Help > Reset > Soft Reset. This sends a message to the ZonePRO to perform a “Soft” Reset and restart itself. ZonePRO Designer will go offline as the processor reboots. Wait for the ZonePRO device to reboot (typically around 30 seconds) then go back online by selecting Go Online from ZonePRO Designer’s Network menu.

**Factory “Hard” Reset From the Front Panel
(1260, 1260m, 640, 640m)**

Press and hold the <2> button on power-up until the following message appears in the display:

```
! HARD RESET?  
Yes  <UTILITY>  
No   <PAGE1>
```

To activate a “Hard” Reset, press the <UTILITY> Button. Pressing any button other than <UTILITY> will abort the “Hard” Reset and cause the device to boot normally.

**Factory “Hard” Reset From ZonePRO Designer
(1261, 1261m, 641, 641m)**

From ZonePRO Designer’s program screen, select Help > Reset > Hard Reset. This sends a message to the ZonePRO to perform a “Hard” Reset and restart itself. ZonePRO Designer will go offline as the processor reboots. Wait for the ZonePRO device to reboot (typically around 30 seconds) then go back online by selecting Go Online from ZonePRO Designer’s Network menu.

8.7 Technical Specifications

640/641

Analog Inputs:

Number of Inputs:	(6 Total) (2) Switchable line or mic inputs (4) RCA Source
Connectors:	Euroblock(Line and Mic) RCA (Source)
Type:	Electronically balanced/RF filtered
Impedance:	> 50 k Ω Balanced, >75 k Ω Unbalanced
Max Input Line Level:	+20 dBu Mic/Line, +12 dBu RCA
CMRR:	> 40 dB, typically >55 dB @ 1 kHz
Mic Pre Gain:	30 to 60 dB
Mic EIN:	< 118 dB, 22 Hz-22 kHz, 150 Ω
Mic Phantom Power:	15 V

Analog Outputs:

Number of Outputs:	4
Connectors:	Euroblock
Type:	Electronically balanced, RF filtered
Impedance:	120 Ω balanced, 60 Ω unbalanced
Max Output Level:	+20dBu

A/D Performance:

Type:	dbx Type IV™ conversion system
Dynamic Range Line:	>113 dB A-weighted, >110 dB unweighted
Type IV Dynamic Range:	>119 dB, A-weighted, 22kHz BW >117 dB, unweighted, 22kHz BW
Sample Rate:	48 kHz

D/A Performance:

Dynamic Range:	112 dB A-weighted, 109dB unweighted
----------------	-------------------------------------

System Performance:

Dynamic Range:	>109 dB A-weighted, >106 dB unweighted,
THD+N:	0.003% typical at +4 dBu, 1 kHz, 0 dB gain
Frequency Response:	20 Hz – 20 kHz, +/- 0.5 dB
Interchannel Crosstalk:	>80 dB typical
Crosstalk Input to Output:	>80 dB
Propagation Delay:	0.6 msec
Operating Voltage:	100 VAC, 50/60Hz, 120 VAC, 60 Hz, 230 VAC 50/60 Hz
Power Requirements:	29 Watts
Operating Temperature Range:	0° to 45° C (32° to 113° F)

Physical:

Weight:	6.8 lbs.(3.1 kg) Shipping weight 8.8 lbs. (4.0 kg)
Dimensions:	1.75" H x 7.75" D x 19" W

640m/641m

Analog Inputs:

Number of Inputs:	(6 Total) (4) Switchable line or mic inputs (2) RCA Source
Connectors:	Euroblock(Line and Mic) RCA (Source)
Type:	Electronically balanced/RF filtered
Impedance:	> 50 k Ω Balanced, >75 k Ω Unbalanced
Max Input Line Level:	+20 dBu Mic/Line, +12 dBu RCA
CMRR:	> 40 dB, typically >55 dB @ 1 kHz
Mic Pre Gain:	30 to 60 dB
Mic EIN:	< 118 dB, 22 Hz-22 kHz, 150 Ω
Mic Phantom Power:	15 V

Analog Outputs:

Number of Outputs:	4
Connectors:	Euroblock
Type:	Electronically balanced, RF filtered
Impedance:	120 Ω balanced, 60 Ω unbalanced
Max Output Level:	+20 dBu

A/D Performance:

Type:	dbx Type IV™ conversion system
Dynamic Range Line:	>113 dB A-weighted, >110 dB unweighted
Type IV Dynamic Range:	>119 dB, A-weighted, 22 kHz BW >117 dB, unweighted, 22 kHz BW
Sample Rate:	48 kHz

D/A Performance:

Dynamic Range:	112 dB A-weighted, 109 dB unweighted
----------------	--------------------------------------

System Performance:

Dynamic Range:	>109 dB A-weighted, >106 dB unweighted,
THD+N:	0.003% typical at +4 dBu, 1 kHz, 0 dB gain
Frequency Response:	20 Hz – 20 kHz, +/- 0.5 dB
Interchannel Crosstalk:	>80 dB typical
Crosstalk Input to Output:	>80 dB
Propagation Delay:	0.6 msec
Operating Voltage:	100 VAC, 50/60 Hz, 120 VAC, 60 Hz, 230 VAC 50/60 Hz
Power Requirements:	27 Watts
Operating Temperature Range:	0° to 45° C (32° to 113° F)

Physical:

Weight:	6.8 lbs.(3.1 kg) Shipping weight 8.8 lbs. (4.0 kg)
Dimensions:	1.75" H x 7.75 " D x 19" W

I260/I261**Analog Inputs:**

Number of Inputs:	12 Total (2) Switchable mic or line, (8) RCA, and (1) S/PDIF
Connectors:	Euroblock (Line and Mic), RCA (Source) and RCA (S/PDIF)
Type:	Electronically balanced, RF filtered
Impedance (Euroblock):	> 50 k Ω Balanced, >25 k Ω Unbalanced, RF Filtered
Impedance (RCA):	>25 k Ω Unbalanced, RF Filtered
Max Input Line Level:	+20 dBu Mic/Line, +12 dBu RCA
CMRR:	> 40 dB, typically >55 dB @ 1 kHz
Mic Pre Gain:	30 to 60 dB
Mic EIN:	> 118 dB, 22 Hz-22 kHz, 150 Ω Source Impedance
Mic Phantom Power:	15 V

Analog Outputs:

Number of Outputs:	6
Connectors:	Euroblock
Type:	Electronically balanced, RF filtered
Impedance:	120 Ω balanced, 60 Ω unbalanced
Max Output Level:	+20 dBu

A/D Performance:

Type:	dbx Type IV™ conversion system
Dynamic Range Line:	>113 dB A-weighted, >110 dB unweighted
Type IV Dynamic Range:	>119 dB, A-weighted, 22 kHz BW >117 dB, unweighted, 22 kHz BW
Sample Rate:	48 kHz

D/A Performance:

Dynamic Range:	112 dB A-weighted, 109 dB unweighted
----------------	--------------------------------------

System Performance:

Dynamic Range:	>110 dB A-weighted, >107 dB unweighted,
THD+N:	0.003% typical at +4 dBu, 1 kHz, 0 dB gain
Frequency Response:	20 Hz – 20 kHz, +/- 0.5 dB
Interchannel Crosstalk:	>80 dB typical
Crosstalk Input to Output:	>80 dB
Propagation Delay:	0.6 msec
Operating Voltage:	100-240 VAC, 50/60Hz
Power Requirements:	27 Watts
Operating Temperature Range:	0° to 45° C (32° to 113° F)

Physical:

Weight:	6.0 lbs.(2.7 kg) Shipping weight 8.0 lbs. (3.6 kg)
Dimensions:	1.75" H x 7.75" D x 19" W

I260m/I261m**Analog Inputs:**

Number of Inputs:	12 Total (6) Switchable mic or line, (4) RCA, and (1) S/PDIF
Connectors:	Euroblock (Line and Mic), RCA (Source) and RCA (S/PDIF)
Type:	Electronically balanced, RF filtered
Impedance (Euroblock):	> 50 k Ω Balanced, >25 k Ω Unbalanced, RF Filtered
Impedance (RCA):	>25 k Ω Unbalanced, RF Filtered
Max Input Line Level:	+20 dBu Mic/Line, +12 dBu RCA
CMRR:	> 40 dB, typically >55 db @ 1 kHz
Mic Pre Gain:	30 to 60 dB
Mic EIN:	> 118 dB, 22 Hz-22 kHz, 150 Ω Source Impedance
Mic Phantom Power:	15 V

Analog Outputs:

Number of Outputs:	6
Connectors:	Euroblock
Type:	Electronically balanced, RF filtered
Impedance:	120 Ω balanced, 60 Ω unbalanced
Max Output Level:	+20 dBu

A/D Performance:

Type:	dbx Type IV™ conversion system
Dynamic Range Line:	>113 dB A-weighted, >110 dB unweighted
Type IV Dynamic Range:	>119 dB, A-weighted, 22 kHz BW >117 dB, unweighted, 22 kHz BW
Sample Rate:	48 kHz

D/A Performance:

Dynamic Range:	112 dB A-weighted, 109 dB unweighted
----------------	--------------------------------------

System Performance:

Dynamic Range:	>110 dB A-weighted, >107 dB unweighted,
THD+N:	0.003% typical at +4 dBu, 1 kHz, 0 dB gain
Frequency Response:	20 Hz – 20 kHz, +/- 0.5 dB
Interchannel Crosstalk:	>80 dB typical
Crosstalk Input to Output:	>80 dB
Propagation Delay:	0.6 msec
Operating Voltage:	100-240 VAC, 50/60Hz
Power Requirements:	27 Watts
Operating Temperature Range:	0° to 45° C (32° to 113° F)

Physical:

Weight:	6.0 lbs.(2.7 kg) Shipping weight 8.0 lbs. (3.6 kg)
Dimensions:	1.75" H x 7.75" D x 19" W

dbx® incorporates high quality mechanical fans in some products. All mechanical fans have a limited life expectancy. We recommend annual inspection of fans for dust occlusion and excessive noise. Fan assemblies should be replaced after six to ten years of use. Environmental factors such as elevated temperature, dust, and smoke can adversely affect fan life. Systems exposed to these conditions should be inspected more frequently. Fan replacement can be performed either at the factory or by an experienced technician in the field. Please contact dbx Technical Support for more information on purchasing replacement parts or product service.

dbx® has a policy of continued product improvement and accordingly reserves the right to change features and specifications without prior notice.

8.8 Wiring Diagrams

**TIA/EIA 568B Straight-Through
Cat 5 Ethernet Cable**

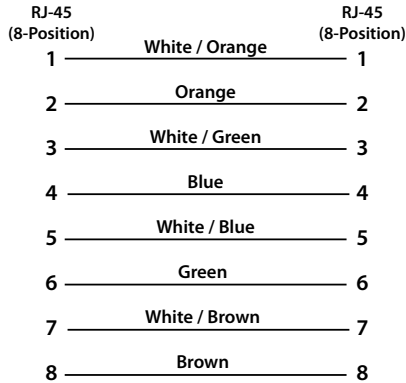

**TIA/EIA 568B Crossover
Cat 5 Ethernet Cable**

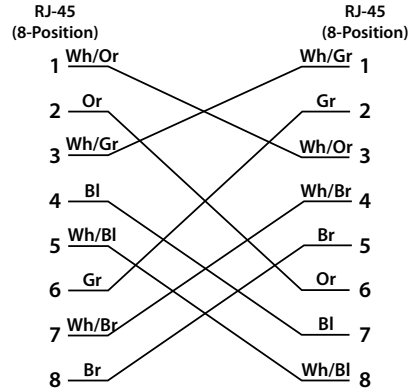

**Link I/O Cable Specifications:
Cat 5 Cable / 4-Twisted Pairs of 24 AWG Wire / 568B Standard**

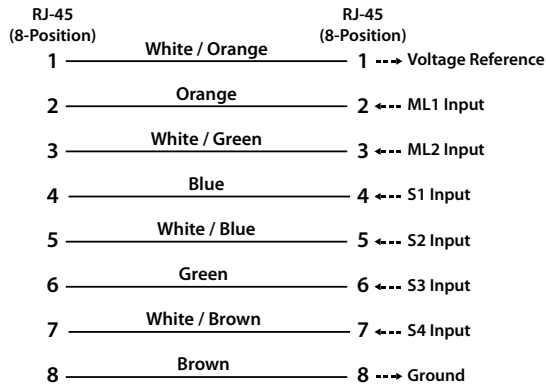

**Zone Controller Cable Specifications:
Cat 5 Cable / 4-Twisted Pairs of 24 AWG Wire / 568B Standard**

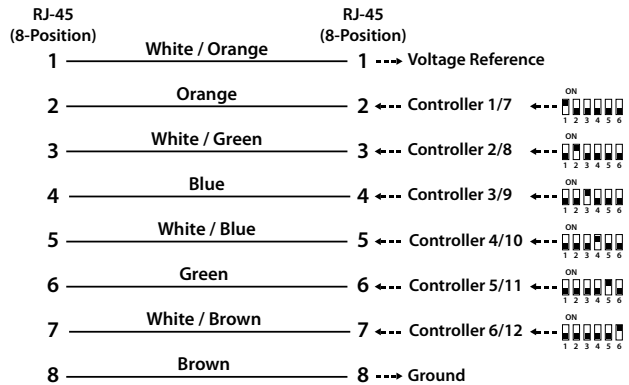

Null Modem Cable

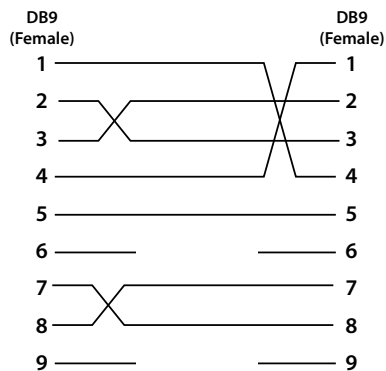

8.9 Copyrights

Portions of code are covered by the following copyrights:

X Consortium

Copyright (C) 1996 X Consortium

Permission is hereby granted, free of charge, to any person obtaining a copy of this software and associated documentation files (the "Software"), to deal in the Software without restriction, including without limitation the rights to use, copy, modify, merge, publish, distribute, sublicense, and/or sell copies of the Software, and to permit persons to whom the Software is furnished to do so, subject to the following conditions:

The above copyright notice and this permission notice shall be included in all copies or substantial portions of the Software.

THE SOFTWARE IS PROVIDED "AS IS", WITHOUT WARRANTY OF ANY KIND, EXPRESS OR IMPLIED, INCLUDING BUT NOT LIMITED TO THE WARRANTIES OF MERCHANTABILITY, FITNESS FOR A PARTICULAR PURPOSE AND NONINFRINGEMENT. IN NO EVENT SHALL THE X CONSORTIUM BE LIABLE FOR ANY CLAIM, DAMAGES OR OTHER LIABILITY, WHETHER IN AN ACTION OF CONTRACT, TORT OR OTHERWISE, ARISING FROM, OUT OF OR IN CONNECTION WITH THE SOFTWARE OR THE USE OR OTHER DEALINGS IN THE SOFTWARE.

Except as contained in this notice, the name of the X Consortium shall not be used in advertising or otherwise to promote the sale, use or other dealings in this Software without prior written authorization from the X Consortium.

X Window System is a trademark of X Consortium, Inc.

Berkeley-based copyrights:

General

Redistribution and use in source and binary forms, with or without modification, are permitted provided that the following conditions are met:

1. Redistributions of source code must retain the above copyright notice, this list of conditions and the following disclaimer.
2. Redistributions in binary form must reproduce the above copyright notice, this list of conditions and the following disclaimer in the documentation and/or other materials provided with the distribution.
3. The name of the author may not be used to endorse or promote products derived from this software without specific prior written permission.

THIS SOFTWARE IS PROVIDED BY THE AUTHOR "AS IS" AND ANY EXPRESS OR IMPLIED WARRANTIES, INCLUDING, BUT NOT LIMITED TO, THE IMPLIED WARRANTIES OF MERCHANTABILITY AND FITNESS FOR A PARTICULAR PURPOSE ARE DISCLAIMED. IN NO EVENT SHALL THE AUTHOR BE LIABLE FOR ANY DIRECT, INDIRECT, INCIDENTAL, SPECIAL, EXEMPLARY, OR CONSEQUENTIAL DAMAGES (INCLUDING, BUT NOT LIMITED TO, PROCUREMENT OF SUBSTITUTE GOODS OR SERVICES; LOSS OF USE, DATA, OR PROFITS; OR BUSINESS INTERRUPTION) HOWEVER CAUSED AND ON ANY THEORY OF LIABILITY, WHETHER IN CONTRACT, STRICT LIABILITY, OR TORT (INCLUDING NEGLIGENCE OR OTHERWISE) ARISING IN ANY WAY OUT OF THE USE OF THIS SOFTWARE, EVEN IF ADVISED OF THE POSSIBILITY OF SUCH DAMAGE.

UCB/LBL

Copyright (c) 1993 The Regents of the University of California. All rights reserved.

This software was developed by the Computer Systems Engineering group at Lawrence Berkeley Laboratory under DARPA contract BG 91-66 and contributed to Berkeley.

All advertising materials mentioning features or use of this software must display the following acknowledgement: This product includes software developed by the University of California, Lawrence Berkeley Laboratory.

Redistribution and use in source and binary forms, with or without modification, are permitted provided that the following conditions are met:

1. Redistributions of source code must retain the above copyright notice, this list of conditions and the following disclaimer.
2. Redistributions in binary form must reproduce the above copyright notice, this list of conditions and the following disclaimer in the documentation and/or other materials provided with the distribution.
3. All advertising materials mentioning features or use of this software must display the following acknowledgement: This product includes software developed by the University of California, Berkeley and its contributors.
4. Neither the name of the University nor the names of its contributors may be used to endorse or promote products derived from this software without specific prior written permission.

THIS SOFTWARE IS PROVIDED BY THE REGENTS AND CONTRIBUTORS "AS IS" AND ANY EXPRESS OR IMPLIED WARRANTIES, INCLUDING, BUT NOT LIMITED TO, THE IMPLIED WARRANTIES OF MERCHANTABILITY AND FITNESS FOR A PARTICULAR PURPOSE ARE DISCLAIMED. IN NO EVENT SHALL THE REGENTS OR CONTRIBUTORS BE LIABLE FOR ANY DIRECT, INDIRECT, INCIDENTAL, SPECIAL, EXEMPLARY, OR CONSEQUENTIAL DAMAGES (INCLUDING, BUT NOT LIMITED TO, PROCUREMENT OF SUBSTITUTE GOODS OR SERVICES; LOSS OF USE, DATA, OR PROFITS; OR BUSINESS INTERRUPTION) HOWEVER CAUSED AND ON ANY THEORY OF LIABILITY, WHETHER IN CONTRACT, STRICT LIABILITY, OR TORT (INCLUDING NEGLIGENCE OR OTHERWISE) ARISING IN ANY WAY OUT OF THE USE OF THIS SOFTWARE, EVEN IF ADVISED OF THE POSSIBILITY OF SUCH DAMAGE.

NVidia Corp

Copyright (c) 1996-1998 NVIDIA, Corp. All rights reserved.

NOTICE TO USER: The source code is copyrighted under U.S. and international laws. NVIDIA, Corp. of Sunnyvale, California owns the copyright and as design patents pending on the design and interface of the NV chips. Users and possessors of this source code are hereby granted a nonexclusive, royalty-free copyright and design patent license to use this code in individual and commercial software.

Any use of this source code must include, in the user documentation and internal comments to the code, notices to the end user as follows:

Copyright (c) 1996-1998 NVIDIA, Corp. NVIDIA design patents pending in the U.S. and foreign countries.

NVIDIA, CORP. MAKES NO REPRESENTATION ABOUT THE SUITABILITY OF THIS SOURCE CODE FOR ANY PURPOSE. IT IS PROVIDED "AS IS" WITHOUT EXPRESS OR IMPLIED WARRANTY OF ANY KIND. NVIDIA, CORP. DISCLAIMS ALL WARRANTIES WITH REGARD TO THIS SOURCE CODE, INCLUDING ALL IMPLIED WARRANTIES OF MERCHANTABILITY AND FITNESS FOR A PARTICULAR PURPOSE. IN NO EVENT SHALL NVIDIA, CORP. BE LIABLE FOR ANY SPECIAL, INDIRECT, INCIDENTAL, OR CONSEQUENTIAL DAMAGES, OR ANY DAMAGES WHATSOEVER RESULTING FROM LOSS OF USE, DATA OR PROFITS, WHETHER IN AN ACTION OF CONTRACT, NEGLIGENCE OR OTHER TORTIOUS ACTION, ARISING OUT OF OR IN CONNECTION WITH THE USE OR PERFORMANCE OF THIS SOURCE CODE.



Phone: (801) 566-8800

Website: dbxpro.com

Support: dbxpro.com/en-US/support

dbx Professional Products
is a registered trademark of HARMAN

© 2017 HARMAN

All rights reserved

ZonePRO® Install Guide

PN: 5059565-B