

DEXIBELL

# VIVO | H7 | H3 |

digital piano

Owner's Manual



## Regulatory and Safety Information

### Users in U.S.A

This product has been tested and found to comply with the limits for a Class B digital devices, pursuant to Part 15 of the FCC Rules. These limits are designed to provide reasonable protection against harmful interference in a residential installation. This equipment generates, uses, and can radiate radio frequency energy and, if not installed and used in accordance with the instructions, may cause harmful interference to radio communications. However, there is no guarantee that interference will not occur in a particular installation. If this equipment does cause harmful interference to radio or television reception, which can be determined by turning the equipment off and on, the user is encouraged to try to correct the interference by one or more of the following measures:

- Reorient or relocate the receiving antenna.
- Increase the separation between the equipment and receiver.
- Connect the equipment into an outlet on a circuit different from that to which the receiver is connected.
- Consult the dealer or an experienced radio/TV technician for help

---

This device complies with part 15 of the FCC Rules. Operation is subject to the following two conditions:

- 1) This device may not cause harmful interference.
- 2) This device must accept any interference received, including interference that may cause undesired operation.

FCC CAUTION: Any unauthorized changes or modifications not expressly approved by the party responsible for compliance could void the user's authority to operate the equipment.

---

Note: The manufacturer is not responsible for any radio or tv interference caused by unauthorized modifications to this equipment. Such modifications could void the user's authority to operate the equipment.

### Radiation Exposure Statement

The available scientific evidence does not show that any health problems are associated with using low power wireless devices. There is no proof, however, that these low power wireless devices are absolutely safe. Low power Wireless devices emit low levels of radio frequency energy (RF) in the microwave range while being used. Whereas high levels of RF can produce health effects (by heating tissue), exposure of low-level RF that does not produce heating effects causes no known adverse health effects. Many studies of low-level RF exposures have not found any biological effects. Some studies have suggested that some

### Users in Canada

This device complies with Industry Canada licence-exempt RSS standard(s). Operation is subject to the following two conditions:

- (1) this device may not cause interference, and
- (2) this device must accept any interference, including interference that may cause undesired operation of the device.

---

Le présent appareil est conforme aux CNR d'Industrie Canada applicables aux appareils radio exempts de licence. L'exploitation est autorisée aux deux conditions suivantes : (1) l'appareil ne doit pas produire de brouillage, et (2) l'utilisateur de l'appareil doit accepter tout brouillage radioélectrique subi, même si le brouillage est susceptible d'en compromettre le fonctionnement.

---

Under Industry Canada regulations, this radio transmitter may only operate using an antenna of a type and maximum (or lesser) gain approved for the transmitter by Industry Canada. To reduce potential radio interference to other users, the antenna type and its gain should be so chosen that the equivalent isotropically radiated power (e.i.r.p.) is not more than that necessary for successful communication.

---

Conformément à la réglementation d'Industrie Canada, le présent émetteur radio peut fonctionner avec une antenne d'un type et d'un gain maximal (ou inférieur) approuvé pour l'émetteur par Industrie Canada. Dans le but de réduire les risques de brouillage radioélectrique à l'intention des autres utilisateurs, il faut choisir le type d'antenne et son gain de sorte que la puissance isotrope rayonnée équivalente (p.i.r.e.) ne dépasse pas l'intensité nécessaire à l'établissement d'une communication satisfaisante.

### Radiation Exposure Statement

The available scientific evidence does not show that any health problems are associated with using low power wireless devices. There is no proof, however, that these low power wireless devices are absolutely safe. Low power Wireless devices emit low levels of radio frequency energy (RF) in the microwave range while being used. Whereas high levels of RF can produce health effects (by heating tissue), exposure of low-level RF that does not produce heating effects causes no known adverse health effects. Many studies of low-level RF exposures have not found any biological effects. Some studies have suggested that some biological effects might occur, but such findings have not been confirmed by additional research. This device has been tested and found to comply with IC radiation exposure limits set forth for an uncontrolled environment and meets RSS-102 of the IC radio frequency (RF) Exposure rules.

---

Les connaissances scientifiques dont nous disposons n'ont mis en évidence aucun problème de santé associé à l'usage des appareils sans fil à faible puissance. Nous ne sommes cependant pas en mesure de prouver que ces appareils sans fil à faible puissance sont entièrement sans danger. Les appareils sans fil à faible puissance émettent une énergie radioélectrique (RF) très faible dans le spectre des micro-ondes lorsqu'ils sont utilisés. Alors qu'une dose élevée de RF peut avoir des effets sur la santé (en chauffant les tissus), l'exposition à de faibles RF qui ne produisent pas de chaleur n'a pas de mauvais effets connus sur la santé. De nombreuses études ont été menées sur les expositions aux RF faibles et n'ont découvert aucun effet biologique. Certaines études ont suggéré qu'il pouvait y avoir certains effets biologiques, mais ces résultats n'ont pas été confirmés par des recherches supplémentaires. Cet appareil a été testé et jugé conforme aux limites d'exposition aux rayonnements énoncées pour un environnement non contrôlé et respecte les règles d'exposition aux fréquences radioélectriques (FR) RSS-102 de l'IC.

# VIVO | H7 |

&

# VIVO | H3 |

## Owner's Manual

Welcome to the reference manual of VIVO H7/H3 and congratulations to purchasing this Digital Piano.

*Before telling you technical information, let me tell you a little about me.*

*I am "VIVO" digital Piano . My designers used a completely new technology called **T2L (True to Life)**, based on interaction between Sampling and Modelling methods.*

*They called me "VIVO" because I am the first digital instruments "ALIVE", I am reactive to your player articulation.*

*I have many features, such as sympathetic resonances, harmonics, noises, staccato sounds, timbre variances, real Sustain Pedal simulation etc. that build-up the total my sound using **320 Oscillators with an unlimited notes polyphony**.*

*The quality standard has been raised-up to **24 bit - 48KHz** with an average of 5 times longer ever recorded samples (15" on lower piano notes).*

*My sounds was recorded with **holophonic** method for an amazing 3D listening experience.*

*You can enjoy the best Grand Pianos, Upright Pianos, Vintage Electric Pianos and many more Sounds Categories with the best quality and playability ever heard.*

*To ensure that you obtain the maximum enjoyment and take full advantage of the piano functionality, please read all sections of this owner's manual carefully.*

**Keep this manual handy for future reference.**



Start to take advantage of valuable benefits available simply registering your product on [www.dexibell.com](http://www.dexibell.com).

- You can benefit of DEXIBELL's **3 years** extended warranty (*The extended warranty is subject to terms and conditions. Please refer to the related section*).
- Keeps you updated on special offers.
- You can be updated on any new software release and new sounds.
- and so much more!

## For European countries



	This Symbol indicates that in EU countries, this product must be collected separately from household waste, as defined in each region. Products bearing this Symbol must not be discarded together with household waste.		Tento symbol vyjadruje, že v krajinách EÚ sa musí zber tohto produktu vykonávať oddelene od domového odpadu, podľa nariadení platných v konkrétnej krajine. Produkty s týmto symbolom sa nesmú vyhazovať spolu s domovým odpadom
	Questo simbolo indica che nei paesi della Comunità europea questo prodotto deve essere smaltito separatamente dai normali rifiuti domestici, secondo la legislazione in vigore in ciascun paese. I prodotti che riportano questo simbolo non devono essere smaltiti insieme ai rifiuti domestici. Ai sensi dell'art. 13 del D.Lgs. 25 luglio 2005 n. 151.		Ez a szimbólum azt jelenti, hogy az Európai Unióban ezt a terméket a háztartási hulladéktól elkülönítve, az adott régióban érvényes szabályozás szerint kell gyűjteni. Az ezzel a szimbólummal ellátott termékeket nem szabad a háztartási hulladék közé dobni.
	Ce symbole indique que dans les pays de l'Union européenne, ce produit doit être collecté séparément des ordures ménagères selon les directives en vigueur dans chacun de ces pays. Les produits portant ce symbole ne doivent pas être mis au rebut avec les ordures ménagères		Tämä merkintä ilmaisee, että tuote on EU-maissa kerättävä erillään kotitalousjätteistä kunkin alueen voimassa olevien määräysten mukaisesti. Tällä merkinnällä varustettuja tuotteita ei saa hävittää kotitalousjätteiden mukana.
	Dieses Symbol bedeutet, dass dieses Produkt in EU-Ländern getrennt vom Hausmüll gesammelt werden muss gemäß den regionalen Bestimmungen. Mit diesem Symbol gekennzeichnete Produkte dürfen nicht zusammen mit den Hausmüll entsorgt werden.		Το σύμβολο αυτό υποδηλώνει ότι στις χώρες της Ε.Ε. το συγκεκριμένο προϊόν πρέπει να συλλέγεται χωριστά από τα υπόλοιπα οικιακά απορρίμματα, σύμφωνα με όσα προβλέπονται σε κάθε περιοχή. Τα προϊόντα που φέρουν το συγκεκριμένο σύμβολο δεν πρέπει να απορρίπτονται μαζί με τα οικιακά απορρίμματα
	Este símbolo indica que en los países de la Unión Europea este producto debe recogerse aparte de los residuos domésticos, tal como está regulado en cada zona. Los productos con este símbolo no se deben depositar con los residuos domésticos.		See sümbol näitab, et EL-i maades tuleb see toode olemprugist eraldi koguda, nii nagu on igas piirkonnas määratletud. Selle sümboliga märgitud tooteid ei tohi ära visata koos olmeprügiga.
	Dit symbool geeft aan dat in landen van de EU dit product gescheiden van huishoudelijk afval moet worden aangeboden, zoals bepaald per gemeente of regio. Producten die van dit symbool zijn voorzien, mogen niet samen met huishoudelijk afval worden verwijderd.		Ta simbol označuje, daje treba proizvod v državah EU zbirati ločeno od gospodinjiskih odpadkov, tako kot je določeno v vsaki regiji. Proizvoda s tem znakom ni dovoljeno odlagati skupaj z gospodinjiskimi odpadki.
	Este símbolo indica que nos países da UE, a recolha deste produto deverá ser feita separadamente do lixo doméstico, de acordo com os regulamentos de cada região. Os produtos que apresentem este símbolo não deverão ser eliminados juntamente com o lixo doméstico.		Šis simbols norāda, ka ES valstīs šo produktu jāievāc atsevišķi no mājsaimniecības atkritumiem, kā noteikts katrā reģionā. Profuktus ar šo simbolu nedrīkst izmest kopā ar mājsaimniecības atkritumiem.
	Dette symbol angiver, at i EU-lande skal dette produkt opsamles adskilt ffa husholdningsaffald, som defineret i hver enkelt region. Produkter med dette symbol må ikke smides ud sammen med husholdningsaffald.		Šis simbolis rodo, kad ES šalyse šis produktas turi būti surenkamas atskirai nuo buitinių atliekų, kaip nustatyta kiekviename regione. Šiuo simboliu paženklinėti produktai neturi būti išmetami kaitų su buitinėmis atliekomis.
	Dette symbolet indikerer at produktet må behandles som spesialavfall i EU-land, iht. til retningslinjer for den enkelte regionen, og ikke kastes sammen med vanlig husholdningsavfall. Produkter som er merket med dette symbolet, må ikke kastes sammen med vanlig husholdningsavfall.		Symbolen anger att i EU-länder måste den här produkten kasseras separat från hushållsavfall, i enlighet med varje regions bestämmelser. Produkter med den här symbolen får inte kasseras tillsammans med hushållsavfall.
	Symbol oznacza, że zgodnie z regulacjami w odpowiednim regionie, w krajach UE produktu nie należy wyrzucać z odpadami domowymi. Produktów opatrzonych tym symbolem nie można utylizować razem z odpadami domowymi.		Tento symbol udává, že v zemích EU musí být tento výrobek sbírán odděleně od domácího odpadu, jak je určeno pro každý region. Výrobky nesoucí tento symbol se nesmí vyhazovat spolu s domácím odpadem.

# 1 Important Safety Instruction

PLEASE READ CAREFULLY BEFORE PROCEEDING



## WARNING

Always follow the following precaution listed below to avoid user to the risk of serious injury or even death from electrical shock, fire or other hazard .

### Only use non-tropical weather

This unit and its AC adaptor can only be safely used in non-tropical weather. The operating temperature range is 5° - 40°C (41° - 104°F).



### Only use at altitude 2000 meter or lower area

This unit and its AC adaptor can only be safely used lower than 2,000 meters altitude.



### Do not repair, modify or replace parts by yourself

Do not attempt to repair the unit, modify or replace parts of the product. Please contact all the nearest Dexibell Service Center.



### Do not disassemble or modify by yourself

Do not open the unit or its AC adaptor or attempt to disassemble or modify the internal component in any way.



### Use only the supplied AC adaptor (VIVO H7: DEXIBELL DYS6150-2400500W, VIVO H3: DEXIBELL DYS602-240250W).

Use only the AC adaptor included with the unit. Connecting a different AC adaptor can cause serious damage to the internal circuitry and may even pose a shock hazard.



### Use only the supplied power cord

Use only the AC power cord supplied with the AC adaptor included in the package.



### Do not excessively bend the power cord

Do not excessively twist or bend the power cord otherwise you damage it. Damaged cords may cause fire and shock hazards!.



### Do not place the unit in an unstable location

Do not place the unit in a unstable position where it might accidentally fall over.



### Take care not to allow liquid or foreign objects to enter unit; Do not place containers with liquid on unit

Do not place object filled with liquid (glass of water on this product. Never allow foreign objects (e.g., flammable objects, coins, wires) or liquids (e.g., water or juice) to enter this product. Doing so may cause short circuits, faulty operation, or other malfunctions.



### Never place or store the product in the following types of locations

- Exposed to extreme cold or heat (such as in direct sunlight, near a heater, or in a car during the day)
- Subject to steam or smoke
- Damp (such washroom, baths, on wet floors)
- Subject to salt water exposure
- Exposed to rain
- Dusty or sandy
- Subject to extreme changes of temperature or humidity (The condensation may occur and water may collect on the surface of the instrument. Wooden parts may absorb water and be damaged)
- Subject to high levels of vibration and shakiness.



### Do not drop the unit or subject it to strong impact

Do not drop the unit. Protect it from strong impact!



### Do not connect the unit to an outlet with an unreasonable number of other devices

Do not connect the unit's power-supply cord to an electrical outlet with an unreasonable number of other devices. This could cause the outlet to overheat and possibly cause a fire.



### Adults must provide supervision in places where children are present

When using the unit in locations where children are present, never leave the unit unattended. Keep a special watch over any children so that they don't mishandling of the unit can take place.



### Avoid extended use at high volume

This unit, either alone or in combination with an amplifier and headphones or speakers, may be capable of producing sound levels that could cause permanent hearing loss. DO NOT operate for a long period of time at a high volume level, or at a level that is uncomfortable. If you experience any hearing loss or ringing in the ears, you should immediately stop using the unit, and consult an audiologist.



### If you notice any abnormality turn off the unit immediately

Turn off the unit and remove the AC adaptor from the outlet when:

- If the AC adaptor, the power-supply cord, or the plug has been damaged
- If smoke or unusual smells occurs.
- If the product has been exposed to rain.
- If objects have fallen into, or liquid has been spilled into the unit.
- If the unit does not operate or exhibits a marked change in performance.
- If the unit has been dropped, or the enclosure of the product has been damaged.



Contact the nearest qualified Service Center.



## CAUTION

Always follow the following precaution listed below to avoid user to the risk of serious injury or even death from electrical shock, fire or other hazard .

**Grasp the plug connecting or disconnecting the AC adaptor**

When removing the electric plug from the instrument or an outlet, always hold the plug itself and not the cord. Pulling by the cord can damage it.



**Do not use wet hands to connect or disconnect AC adaptor**

Never handle the AC adaptor or its plugs with wet hands when plugging into, or unplugging from, an electrical outlet.



**Keep clean the AC adaptor's plug**

At regular intervals, unplug the AC adaptor and using a dry cloth clean the adaptor's plug.

If the unit will be unused for an extended period of time, unplug the AC power cord from the AC outlet.



**Keep cables from getting entangled**

Try to prevent cords and cables from becoming entangled. Place all cords and cables away from children.



**Before cleaning the unit, unplug the AC adaptor from the outlet**

To avoid electric shock or damage the unit, before cleaning the unit, turn it off and unplug the AC adaptor from the outlet (p. 18).



**If there is a possibility of lightning strike in your area, disconnect the AC adaptor from the outlet**

If you know a thunderstorm is predicted in your area, disconnect the AC adaptor from the outlet.



**Take care so as not to get fingers pinched by lid**

Be careful to avoid catching fingers (yours, or others, especially children's) when opening or closing the lid. Adult supervision is recommended whenever small children use the unit.



**Do not rest your weight on or place heavy objects on the unit.**

Avoid to climb on top of, nor place heavy objects on the unit.



**Cautions when moving this unit**

- When transporting or moving the unit always use two or more people. Attempting to lift the unit by yourself may damage your back, result in other injury, or cause damage to the unit itself.
- The unit should be handled carefully, all the while keeping it level.
- Disconnect the power cord and all connected cables.
- Close the lid.



**Place in a well ventilated location**

The unit and the AC adaptor should be located so their location or position does not interfere with their proper ventilation.



**Do not use in tropical climates**

Use the unit and the AC adaptor only in a moderate climates (not in tropical climates).



**Place near the socket outlet**

This equipment should be installed near the socket outlet and disconnection of the device should be easily accessible



# 2 Relevant Indications

In addition to the items listed under "Important Safety Instruction" on p. 5, please read and observe the following:



## Power supply related

- Do not plug this unit into the same electrical outlet used same by an electrical appliance that is controlled by an inverter or a motor (such as a refrigerator, washing machine or air conditioner). Doing so, can result an audible noise.
- The power adaptor may become warm after long hours of consecutive use. It can be a normal dissipation of heat through the adaptor casing. To reduce the possibility of overheating place the power adaptor on the floor in a well-ventilated location.
- Before connecting the unit to other equipment, turn off the power to all equipment. Otherwise, electrical shock or damage to the equipment may occur.
- If the unit is not operative for 120 minutes, to prevent unnecessary power consumption, this unit features an "AUTO OFF" function that automatically turns the unit off. If you don't want the unit to turn off automatically, change the "AUTO OFF" setting to "OFF" as described on "Auto OFF" (p. 52).

### NOTE

The "AUTO OFF" setting is memorized when you switch off the unit.



## Maintenance related

- To clean the unit, put a soft cloth in lukewarm water, squeeze it well, then wipe the entire surface using an equal amount of strength. Rubbing too hard in the same area can damage the finish.
- If your unit has a **polished finish**, it needs careful, periodic care. Dust should be removed using a soft feather or wool-type duster. Care should be taken not to apply pressure to the finish or to drag the dust across the finish, which can create fine scratches in the surface. Fingerprints or similar marks can be cleaned with a dampened soft cloth, followed by a dry cloth. In cases of stubborn greasy dirt, using a small amount of mild detergent (such as mild dishwashing liquid) on the damp cloth may help. Do not use any cleaners or detergents, since they might deteriorate the surface of the cabinet, and produce cracks. Do not use dusting cloths that contain chemicals.
- Do not wipe this unit with benzene, alcohol or solvent of any kind. Doing so may result in discoloration and/or deformation of the unit.



## Related to appropriate location

- Do not place the unit near power amplifiers (or other equipment containing large power transformers) to avoid induced hum. In case of hum, to reduce the problem, change the orientation of your unit or place it away from the source of interference.
- Do not use this unit in the vicinity of a TV or radio. This unit may interfere with radio and television reception.
- When using this unit along with application on your iPhone/iPad, we recommend that you set "Airplane Mode" to "ON" on your iPhone/iPad in order to avoid noise caused by communication.
- Noise may be produced if cell phones are operated in the vicinity of this unit. In case of noise you should relocate such wireless devices so they are at a greater distance from this unit, or switch them off.
- Do not expose the unit to extreme cold or heat, to direct sunlight or near devices that radiate heat. Do not leave the unit inside a vehicle during the day. Extreme temperature can damage the unit.
- Take care when move the unit from one location to another with drastic changes in ambient temperature. Condensation can occur in the unit due to drastic change of temperature. Using the device while condensation is present can cause damage. If there is reason to believe that condensation might have occurred, leave the device for several hours until the condensation has completely dried out.
- Do not place, for long periods of time, vinyl, plastic or rubber objects on this unit. Such objects can discolor or otherwise harmfully affect the finish.
- Do not place objects for long period of time on top of the keyboard. This can be the cause of malfunction of the keys of the keyboard.
- Do not apply any stickers, decals or self-adhesive material to this unit. The glue is difficult to remove and solvents are damaging the exterior finish.
- Do not place object filled with liquid (glass of water on this unit. Avoid to use alcohol, perfume, hairspray, nail polish, etc., near the unit. In the event of liquid spill on the unit, swiftly wipe away the surface using a dry, soft cloth.



## Related to repairs

- Always back up your data on a USB memories before you send this unit for repair to an authorized center. All data contained in the unit's memory may be lost. Important data should always be backed up, or written down on paper (when possible). Dexibell assumes no liability concerning such loss of data.



## Related to external memories

- Insert the USB Memory (commercially available) into the slot with care and at the correct angle.
- Take particular care when handling USB Memory:
  - Always ground yourself to something metal before handling an USB Memory
  - Do not touch the pins of the USB Memory connector, or allow them to become dirty.
  - Do not subject the USB Memory to temperature extremes (e.g., direct sunlight in an enclosed vehicle)
  - Do not allow the USB Memory to become wet
  - Do not drop or subject it to excessive shock or vibration.
- Do not disconnect the USB Memory while writing and reading data (i.e., while the USB Memory indicator blinks).
- Never use USB hub to connect USB Memory to the unit.
- This unit allows you to use commercially available USB Memory. You can purchase such devices at a computer store, a digital camera dealer, etc
- The audio recording require a USB storage device to support high sustained transfer rates. Not all USB devices will guarantee flawless performance.



### Other precautions

- The contents of memory could be lost due to malfunction or improper operation. To help prevent the loss of your data, we highly recommend that you periodically save a backup copy of important data you have stored in the unit's memory on another storage device. (e.g., USB memories).
- Unfortunately, an error may occur during the data restore previously stored in the USB memories. Dexibell shall not be liable for loss of profits or any consequential loss, loss of data.
- Do not use excessive force when handling unit's buttons, switches, sliders and controls and when use connectors and jacks. Rough handling can cause damage o malfunctions.
- Do not to apply strong pressure on the display.
- Always pull by the connector when disconnecting a cable, never pull the cable Not doing so you will cause shorts, or damage to the cable's internal elements.
- Keep the unit's volume levels down. The instrument should be used at a reasonable volume, to avoid disturbing neighbours, especially at night and in the early morning. Use headphones if you want to play your music loud or late at night.
- When you need to transport the unit, put it in its original packaging with padding in the box. Otherwise, you will need to use equivalent packaging materials. When transporting or moving the unit always use two or more people.
- To prevent possible damage, avoid applying excessive force to the music stand.
- For connecting this unit use cable low impedance cables. The use of cables that contain resistor can cause the sound level to be extremely low, or impossible to hear.



### Related to copyright and trademarks

- Dexibell do not assume legal liability regarding any infringements of the user through the use of this unit.
- Recording, copying, distribution of copyrighted material (songs, live performance, etc.) belonging to a third party in part or in whole without the permission of the copyright owner is forbidden by law.
- Copyright © 2003 by Bitstream, Inc. All rights reserved. Bitstream Vera is a trademark of Bitstream, Inc.
- iPad® and iPhone® are registered trademarks of Apple Inc.
- App Store™ is an Apple's Service Mark
- Bluetooth® is registered trademarks of Bluetooth SIG, Inc.



### Conventions Used in This Manual

The following symbols are used.

- NOTE** It indicates an important note; be sure to read it.
- MEMO** It indicates a memo regarding the setting or function; It's up to you read it.
- TIPS** It indicates a useful hint for operation; read it as necessary.



# Contents

<b>Important Safety Instruction</b> .....	5
<b>Relevant Indications</b> .....	7
<b>Panel Description</b> .....	10
<b>Connections Quick Guide</b> .....	13
<b>Quick Guide</b> .....	14
<b>Before You Start to Play</b> .....	16
Connecting the AC Adaptor .....	16
Connecting the Pedal Cord .....	16
Listening Through Headphones .....	16
Connecting an External Amplifier .....	17
Connecting Digital Player devices .....	17
Opening and Closing the Lid .....	17
Opening the Lid .....	17
Closing the Lid .....	17
Connecting the VIVO H7/H3 to Your Computer .....	18
Connecting an USB Memory (commercially available) .....	18
Safely Remove the USB Memory .....	18
Turning the Power On/Off .....	18
Turning the Power Off .....	19
Demo of the VIVO H7/H3 .....	19
<b>Basic Operation</b> .....	20
About the Display and Cursor Operation .....	20
Main Page .....	20
Moving the cursor and setting parameter values .....	21
Assigning the Name You Specify .....	21
<b>Selecting Tones</b> .....	22
Grand Piano Mode .....	22
How to Select Tones .....	22
Most Frequently Used Tones (Favorite Tone) .....	22
Playing Two Sounds Over the Entire keyboard (Layer) .....	23
Splitting the Keyboard Range and Playing Two Different Tones .....	23
How to change the Split Point .....	23
Mute the Lower Part .....	24
<b>Additional Sound</b>  .....	25
Importing USER Sound Library .....	25
How to Select USER Sound  .....	25
Deleting USER Sound Library .....	26
<b>Four Hands Mode</b> .....	27
How to adjust the volume balance between the Left and Right Piano Section .....	27
<b>Sound Effects</b> .....	28
Going Around Sound Effects .....	28
Adding Reverb to the Sound .....	28
<b>Personalizing Your Sounds</b> .....	29
T2L Sound Parameters .....	29
Making Slight Additions or Sound Alterations .....	30
<b>Other Functions</b> .....	31
Transposing the pitch of the keyboard .....	31
Shifting the Tuning of a Keyboard Part in Octave Steps .....	31
Practicing with the Metronome .....	31
Metronome Settings .....	31
How to Adjust the Tempo Value .....	32
Use Tap Tempo Function to set the Tempo Value .....	32
Setting the Metronome Time Signature .....	32
Adjusting the Keyboard Response (Key Touch) .....	33
Adjusting the AUDIO IN Input Level .....	33
Master Equalizer .....	33
Master Equalizer Preset .....	33
Saving Your User Preset .....	34
Restoring the Factory Settings (Factory Reset) .....	34
<b>Practice with Song Player</b> .....	35
Playing a Song .....	35
Useful Song Controls .....	35
<b>Recording Your Performance</b> .....	37
Recording Your Music as audio data (WAVE) .....	37
How to Record your Performance over an Existing Audio Base (Overdub) .....	37
<b>Working with the Memories</b> .....	38
About the Memories and Memory Set structure .....	38
Saving Your Settings in the Internal Memory .....	38
Recalling your Settings from Internal Memory .....	38
Saving Your Settings in the USB Memory (commercially available) .....	38
Recalling your settings from an USB Memory .....	40
Renaming a Memory .....	40
Exporting a Memory Set in the USB Memory .....	40
Importing a Memory Set from the USB Memory .....	41
<b>Playing with Audio Backing Tracks</b> .....	42
Connecting your Mobile Device .....	42
Playing with X MURE Application .....	42
<b>Wireless Function</b> .....	43
Bluetooth® Audio Connectivity .....	43
Preliminary Operation, Pairing a Mobile Device .....	43
Connecting an Already Paired Mobile Device .....	44
Removing a Paired Mobile Device .....	44
<b>MENU Options (Advanced Section)</b> .....	45
General procedure .....	45
SETTING Parameters Group .....	46
T2L EDITOR .....	47
EFFECTS .....	47
CONTROL .....	47
TEMPO .....	48
TUNING .....	48
MEMORY .....	50
USB REMOVE .....	50
AUDIO INPUT .....	50
BLUETOOTH .....	50
MIDI .....	50
GLOBAL .....	51
FACTORY RESET .....	52
VERSION INFO .....	52
<b>Appendix</b> .....	53
Effects Types and Parameters List .....	53
H7/H3 Tone List .....	55
<b>Troubleshooting</b> .....	56
<b>Specifications</b> .....	57
<b>Index</b> .....	59

# 3 Panel Description

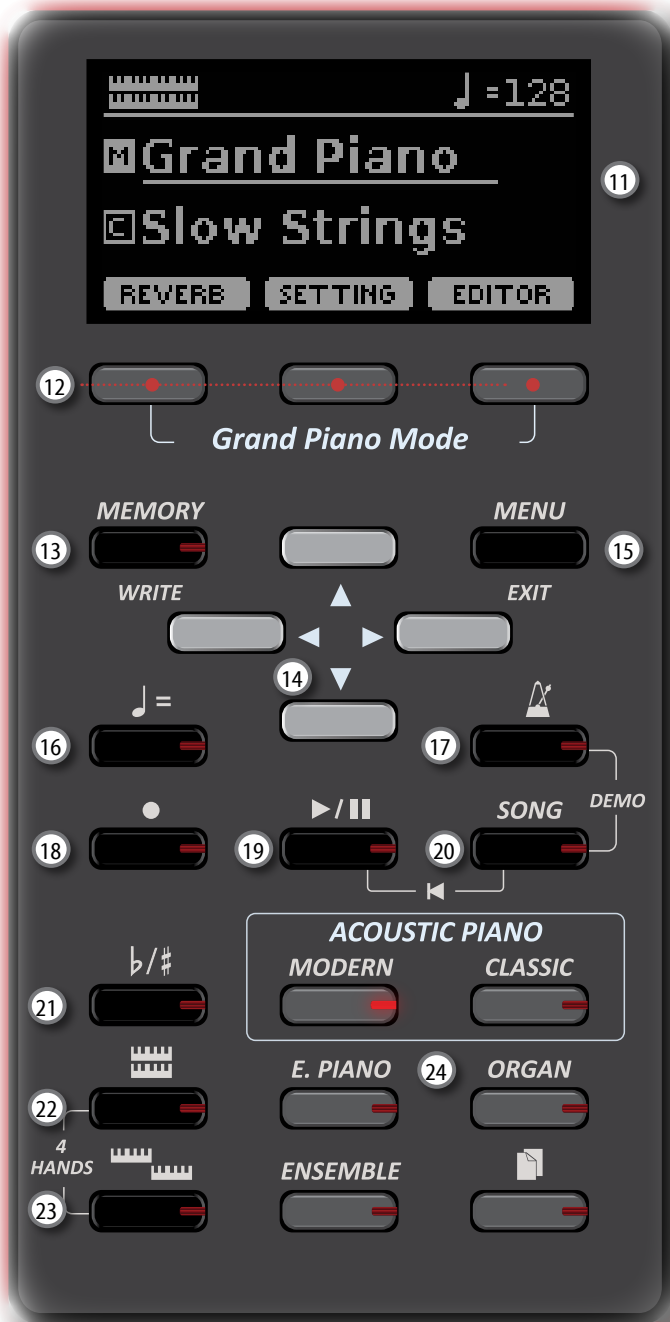

1

Turns the power on or off (p. 18).

**With the factory settings VIVO H7/H3's power will automatically be switched off 120 minutes after you stop playing or operating the VIVO H7/H3.**

If VIVO H7/H3's power has been turned off automatically, you can use the [POWER] switch to turn the VIVO H7/H3 back on. If you don't want the power to turn off automatically, set the "AUTO OFF" parameter to "OFF" (p. 52).

**NOTE**

To avoid malfunctions, never disconnect the AC/DC adaptor while the instrument is turned on.

2 **VOLUME**

Use this knob to set VIVO H7/H3's overall volume.

3 **USB Computer Port**

Use a USB cable to connect the VIVO H7/H3 to your computer via this connector (p. 18).

4 **USB Memory Port**

Connect an commercially available USB Memory here.

**NOTE**

\* Carefully insert the USB Memory making sure that the connector on the device is appropriate and that it is connected in the proper direction.

\* Dexibell does not recommend using USB hubs, irrespective of whether they are active or passive. Please connect only one USB Memory to this port

5 **Damper Pedal**

Use this pedal to sustain the sound (p. 47).

6 **Sostenuto Pedal**

The notes you are pressing when this pedal is depressed will be sustained, allowing future notes played to be unaffected (p. 47).

7 **Soft Pedal**

This pedal is used to reduce the volume and slightly changes the timbre (p. 48).

8 **AUDIO IN**

This mini jack allow you to connect the audio outputs of an external signal source (CD/mp3 player, etc.).

9 **PHONES output**

This is where you can connect one or two pairs of optional headphones.

Doing so switches off the internal speakers.



10 **Headphones Hook**

Here you can hang your headphones.

11 **Display**

This display shows information related to your operation.

12 **Function buttons**

These buttons are used to select one of three functions/ options shows at the bottom of the display.

13 **MEMORY/WRITE button**

This button allows you shows the list of memories and then recall one of them. (See p. 38).

Pressing and holding this button to write a memory (See p. 38).

14 **Arrow buttons**

These buttons are used to navigate around the various menus, adjust values.

15 **MENU/EXIT**

This button allows you to open and close the menu page where you can view and select all available functions.

16 **♩ = (Tempo)**

Use this button to change the tempo of metronome.

You can also enter tempos simply by tapping your finger on the button.

17 **🎵 (Metronome)**

This button allows you to turn the metronome on or off.

18 **● (Rec)**

This button is used to start or stop the recording of your song (See p. 37).

19 **▶/||**

Press this button to start playing. Press it again to stop playing (See p. 35).

Press and hold it while pressing the [SONG] button to return to the beginning of the song.

20 **SONG**

This button allows you to switch in Song Mode (See p. 35).

Press it together with the  button to listen the demo song.

21 **b/#**

This button calls up the transposition function (See p. 31). Its settings can be applied to the keyboard.

If the button indicator doesn't light the instrument use its normal pitch.

22 

This button enable or disable the layer keyboard mode (See p. 23).

Press it together with the  button to enable or disable the "4 HANDS" keyboard mode.

23 

This button enable or disable the split function (See p. 23).

Press it together with the  button to enable or disable the "4 HANDS" keyboard mode.

24 **These buttons allow you to select tones by category**

# Rear Side

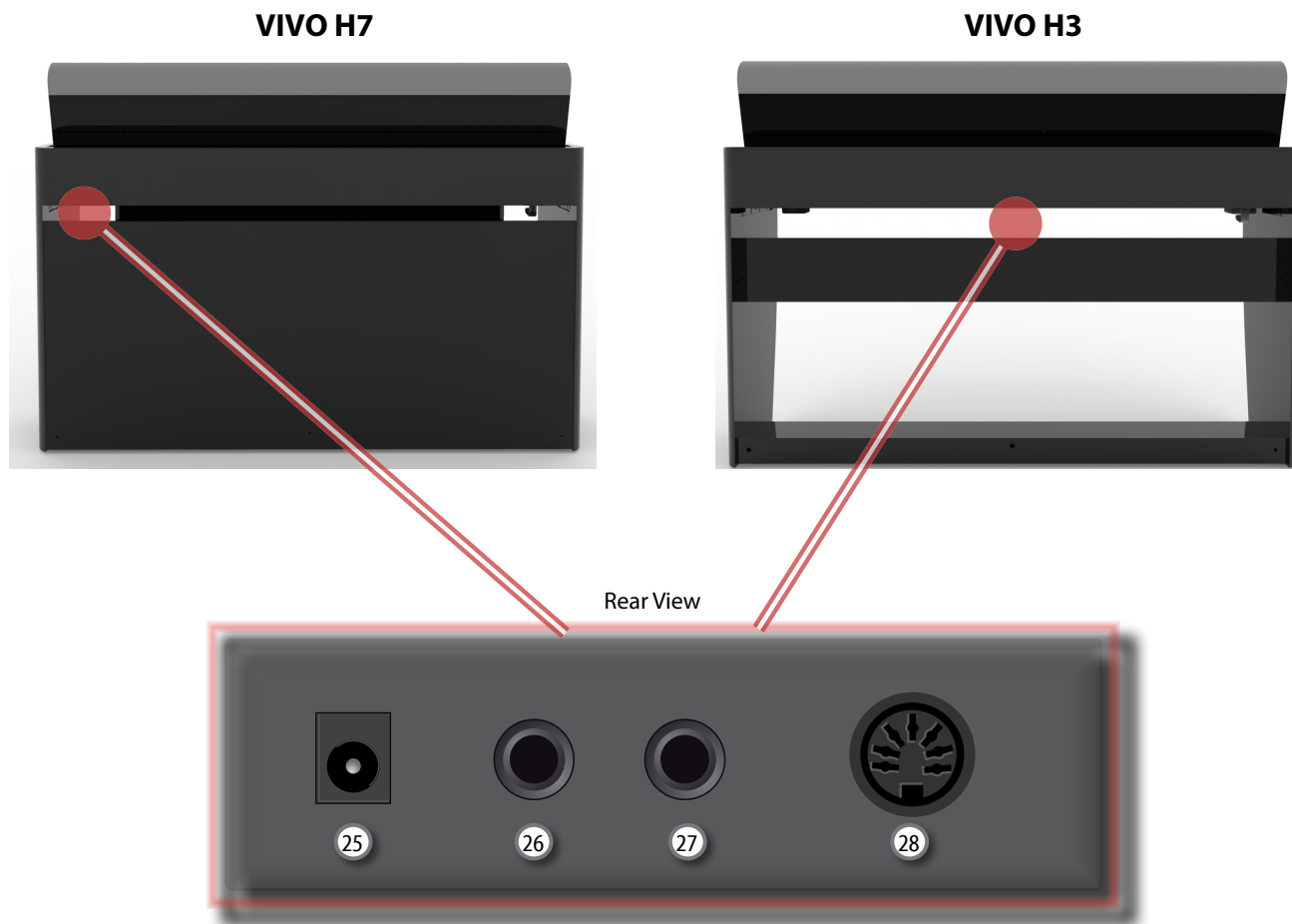

**25 DC IN socket**

Connect the supplied AC/DC adaptor here (p. 16).

**26 AUDIO OUTPUT R jack**

This socket allows you to connect an external amplified speakers.

**27 AUDIO OUTPUT L/MONO jack**

This socket allows you to connect an external amplified speakers.

**28 Pedals Socket**

Here is were you connect the pedal cable.

# 4 Connections Quick Guide

## Peripheral Devices

### NOTE

Before to connect any external device to Audio IN socket, rotate the [VOLUME] knob toward the lower position to minimize the volume.

### Audio Bluetooth

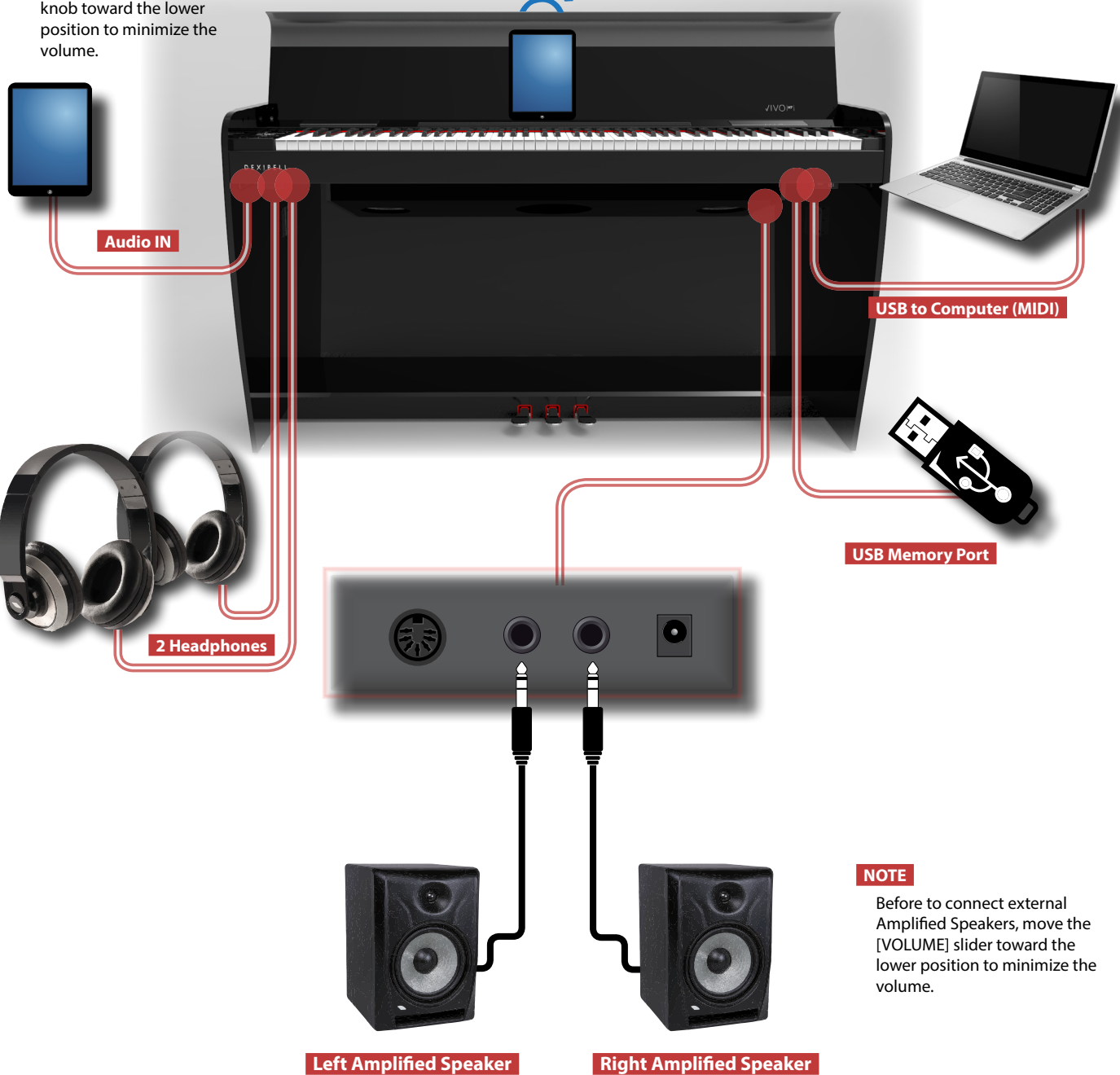

### NOTE

Before to connect external Amplified Speakers, move the [VOLUME] slider toward the lower position to minimize the volume.

# 5 Quick Guide

## Reverberation

You can modify the reverberation to the sound to your liking.  
Press the Function button that shows "REVERB" at the bottom of the display.  
Use the [▲] [▼] and [◀] [▶] buttons to select a pleasant reverberation.

## Function Buttons

Press these buttons to select functions/options shows at the bottom of the display.

## Grand Piano Mode

When you want to reset various settings and play Grand Piano:  
From the Main page, simultaneously press the first and last Function button.

## Menu/Exit Button

Press this button to open and close the menu page where you can view and select all available functions..

## Using the metronome

Press the [🎵] button to start the metronome.  
To adjust the tempo and time signature use the [♩=] button.

## Listening the Demo Song

Simultaneously press the [🎵] and [SONG] buttons.

## Changing the Tempo/Time Signature

You can adjust the tempo of the metronome.  
Press the [♩=] button to display the tempo page.  
Use the [▲] [▼] buttons to select the tempo, the time signature field or an available preset tempo  
Use the [◀] [▶] buttons to adjust the value.

## Favorite Settings

### HOW TO MEMORIZE YOUR FAVORITE SETTING

The VIVO H7/H3 allows you to memorize your favorite settings for easy recall whenever they're needed. Up to 20 complete setups can be saved.

Press and hold the [MEMORY/WRITE] button to call up the memories page.

Use the [▲] [▼] buttons to select one of the memory location.

Press the function button that shows "SAVE" at the bottom of the display

Use the [▲] [▼] and [◀] [▶] buttons to enter the desired name.

To confirm press the function button that shows "OK" at the bottom of the display

### HOW TO RECALL YOUR FAVORITE SETTING

Press the [MEMORY] button to call up the memories page.

Use the [▲] [▼] buttons to select one of the memory location.

Press the "RECALL" function button under the display to select the memory.

p. 38

### MEMO

Note that it is also possible to memorize and recall directly on an USB Memory (commercial available).

p. 32



### Turning the Power On

Press the VIVO H7/H3's [ ] switch.

p. 18

### Adjusting Volume

Adjust the volume rotating the knob

### Recording a Song

Press the [ ] button to start recording.  
 Play your song.  
 Press the [ ] button again to stop recording.

p. 37

### Selecting and Playing a Song

Press the [SONG] button to display the Song main page.  
 Press the "SONG LIST" Function button  
 Use the [▲] [▼] buttons to select a song.  
 Press the [▶/||] button to start playing.

p. 35

### Keyboard Mode Selection

At power-on, you play a piano sound over the entire keyboard (The [ ] and [ ] indicators are off).

Sound A

Press the [ ] button to play two different sounds over the entire keyboard.

Sound A + Sound B

Press the [ ] button if you want to play different sounds with your left and right hands.

Sound C | Sound A

Split Point

To enter in "4 hands" mode, simultaneously press the [ ] and [ ] button.

Sound A

Split Point

p. 22

### Selecting a Tone

Press one of the family tone buttons  
 Press [▲] [▼] to select another desired tone in the list  
 Press [◀] [▶] to select another family tone

HOW TO SET A FAVORITE TONE

Press and hold the family button of the selected tone

p. 22

p. 22

### Transposing the Keyboard

Press the [b/#] button to calls up the page where you can change the transposition value.  
 Use the [◀] [▶] buttons to change the value.

p. 31

# 6 Before You Start to Play

## Connecting the AC Adaptor

1. Rotate the [VOLUME] knob toward the left position to minimize the volume.

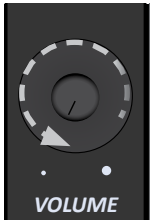

2. Connect the included power cord to the AC adaptor.

The indicator will light once you plug the AC adaptor into a wall outlet (Only for the VIVO H3 model).



### NOTE

Depending on your area, the included power cord may differ from the one shown above.

### NOTE

Be sure to use only the AC adaptor (H7: DEXIBELL DYS6150-2400500W, H3: DEXIBELL DYS602-240250W) supplied with the unit. Also, make sure the line voltage at the installation matches the input voltage specified on the AC adaptor body. Other AC adaptors may use a different polarity, or be designed for a different voltage, so their use could result in damage, malfunction, or electric shock.

### NOTE

If you won't be using the VIVO H7/H3 for an extended period of time, disconnect the power cord from the electrical outlet.

### NOTE

To avoid malfunctions, never disconnect the AC/DC adaptor while the instrument is turned on.

3. Connect the AC adaptor to VIVO H7/H3's DC IN jack positioned to the rear bottom panel.

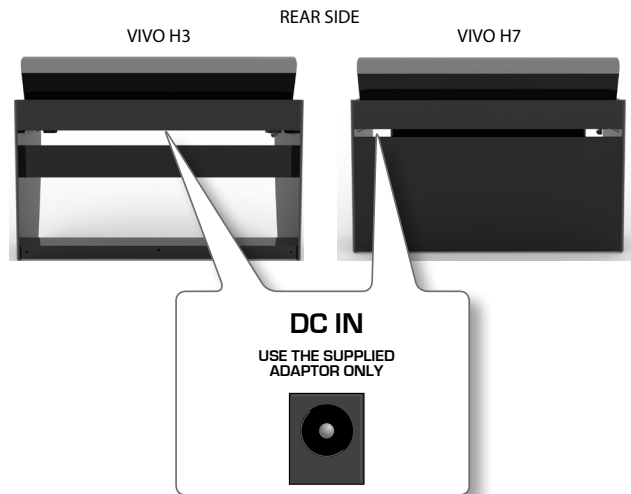

## Connecting the Pedal Cord

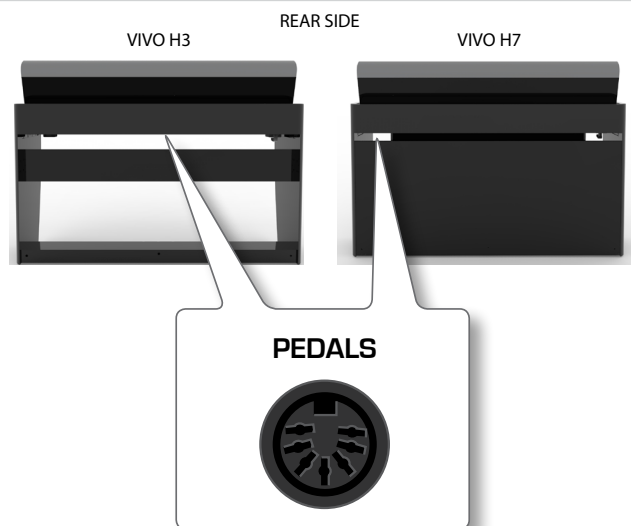

1. Connect the pedal cord that come from the dedicated stand here.

For further information see the Assembling Manual.

## Listening Through Headphones

You can use headphones to enjoy the VIVO H7/H3 without disturbing those around you, such as at night.

1. Here you can connect stereo headphones. VIVO H7/H3 has two headphones jacks. Two people can use headphones simultaneously.



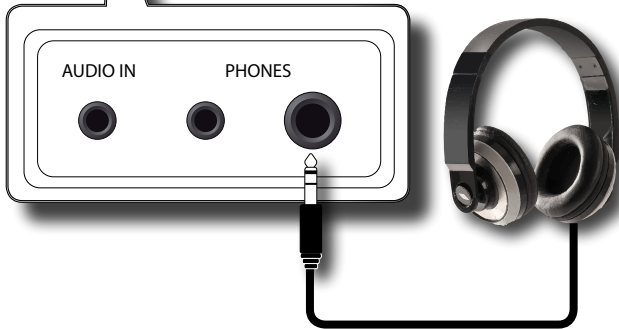

2. Rotate the VIVO H7/H3's [VOLUME] knob to adjust the volume of the headphone.

### Cautions when using headphones

- To prevent damage to the cord's internal conductors, avoid rough handling. When using headphones, mainly try to handle either the plug or the headset.
- Your headphones may be damaged if the volume of a device is already turned up when you plug them in. Minimize the volume before you plug in the headphones.
- Excessive input will not only damage your hearing, but may also strain the headphones. Please enjoy music at a reasonable volume.

## Connecting an External Amplifier

You can connect the OUTPUT jack to external amplifier, stereo system, or other stereo audio device.

1. Rotate the [VOLUME] knob toward the left position to minimize the volume.
2. Connect the VIVO H7/H3's OUTPUT jacks positioned to the right rear bottom panel to the inputs of your external amplifier.

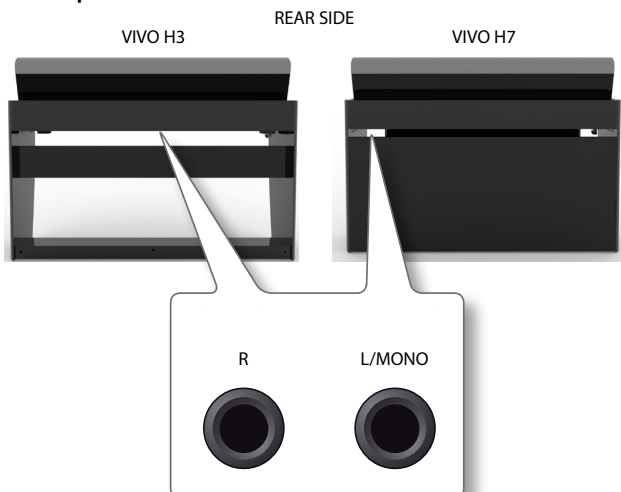

## Connecting Digital Player devices

You can connect the INPUT jack to an audio playback device. The audio of playback will be reproduced with the VIVO H7/H3's internal speakers.

1. Rotate the [VOLUME] knob toward the left position to minimize the volume.
2. Connect the VIVO H7/H3's INPUT jack positioned to the left front bottom panel to the output of an external signal source.



### MEMO

You can adjust the volume of device connected to the VIVO H7/H3's INPUT jack. See "AUDIO INPUT" (p. 50).

See "Adjusting the AUDIO IN Input Level" (p. 33) to adjust the audio source level.

## Opening and Closing the Lid

### NOTE

- This unit is equipped with a safe closing system to avoid finger injuries when opening or closing the lid. Anyway be careful to avoid catching your fingers when opening or closing the lid. Adult supervision is recommended whenever small children use the unit.
- If you need to move the unit, make sure that the lid is closed to prevent accidents.

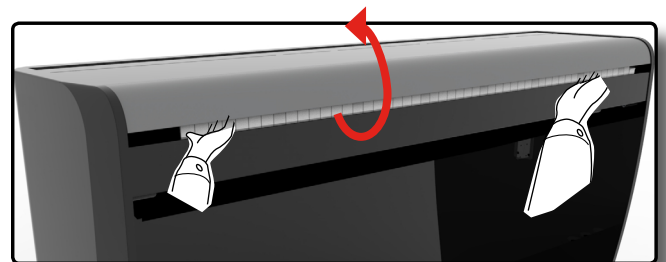

## Opening the Lid

### WARNING

- Do not release the lid until it is fully opened.

1. Hold the front edge of the lid with both hands, then open

the lid slowly until it reach the end-of-stroke position.

## Closing the Lid

### WARNING

- Allow the lid to close automatically. Do not force the lid.
- Be careful to avoid catching your fingers when closing the lid. Adult supervision is recommended whenever small children use the unit.

1. Hold the lid with both hands and slowly accompany it to close automatically.

Allow the lid to close automatically. Do not force the lid.

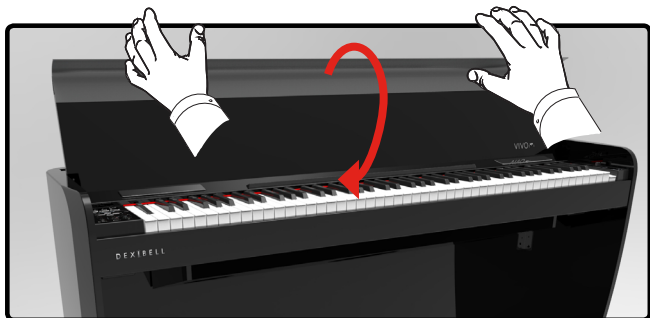

## Connecting the VIVO H7/H3 to Your Computer

- If you use a USB cable (commercially available) to connect the COMPUTER port located on the VIVO H7/H3's rear panel to the USB port of your computer, you'll be able to transfer MIDI data between the VIVO H7/H3 and your sequencer software.

### NOTE

VIVO H7/H3 does not support GM/GS standard.

### What do you need to connect the VIVO H7/H3 with your computer?

- USB cable (type A→male - type B→male: commercially available)

1. Use a standard USB cable (A→B-type connectors, commercially available) to connect the VIVO H7/H3 to your computer as shown below.



### NOTE

- To avoid the risk of malfunction and/or damage to external speakers, always turn the volume all the way down and switch off the power on all devices before you make any connections.
- Only MIDI data can be transmitted and received via USB. Audio data cannot be transmitted or received.
- Switch on the power to the VIVO H7/H3 before you start up the MIDI application on your computer. Never turn the VIVO H7/H3's power on/off while your MIDI application is running.

## Connecting an USB Memory (commercially available)

1. Plug an USB Memory to the MEMORY port on the VIVO H7/H3's right panel located under the keyboard.

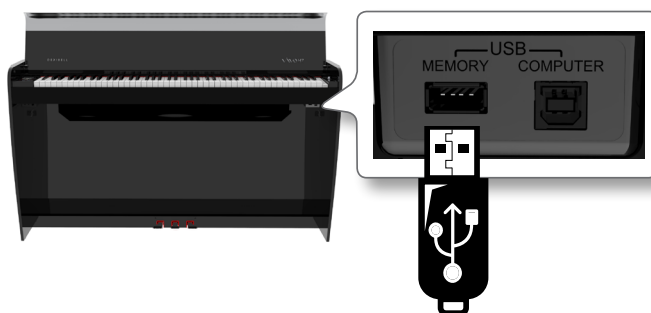

### NOTE

Carefully insert the USB Memory making sure that the connector on the device is appropriate and that it is connected in the proper direction.

## Safely Remove the USB Memory

### NOTE

You should always safely eject the USB Memory before physically unplugging it from USB socket. Before to unplug the USB Memory use the "USB REMOVE" function.

1. Press the "MENU" button.
2. Use the [▲] [▼] buttons to scroll the list and select the "USB REMOVE" function .
3. Use the [▲] [▼] buttons to scroll the list and select the "USB REMOVE" function .

4. Press the [▶] buttons to access the function.

The display shows:



1. Press the "YES" Function button to safely remove the USB Memory.

Now you can unplug the USB Memory safely.

## Turning the Power On/Off

Once everything is properly connected, be sure to follow the procedure below to turn on their power.

1. Rotate the [VOLUME] knob toward the left position to minimize the volume.

**NOTE**

Before turning the VIVO H7/H3 on/off, always be sure to turn the volume down. Even with the volume turned down, you might hear some sound when switching the VIVO H7/H3 on/off. However, this is normal and does not indicate a malfunction.

2. Press the VIVO H7/H3's [⏻] button located on the right panel to switch it on.

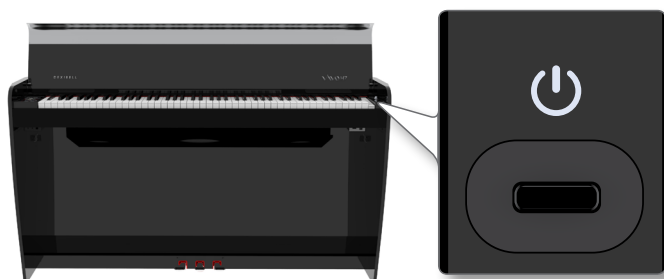

The power will turn on, a progress bar appear in the VIVO H7/H3's display..



After a brief interval, the main page will appear. and VIVO H7/H3 will be ready to produce sound.



3. Use the [VOLUME] knob to adjust the volume.

**NOTE**

This unit is equipped with a protection circuit. A brief interval (a few seconds) after power up is required before the unit will operate normally.

## Turning the Power Off

1. Rotate the [VOLUME] knob toward the left position to minimize the volume.

**NOTE**

To avoid malfunctions, never disconnect the AC/DC adaptor while the instrument is turned on.

2. Press the VIVO H7/H3's [⏻] switch.

A power off confirmation message appears:



3. Press the "YES" Function button to confirm.

The display shows the following message:



and the unit will turn off after few seconds.

If you do not want power off press the "NO" Function button.

**NOTE**

If you need to turn off the power completely, first turn off the [⏻] button, then unplug the power cord from the power outlet. Refer to "Connecting the AC Adaptor" (p. 16).

**If you do not operate the unit for a certain period of time while the power is on, this unit turns off automatically.**

**If you don't want the power to turn off automatically, turn the "AUTO OFF" setting off!**

**With the factory settings, the unit's power will automatically be switched off 120 minutes after you stop playing or operating the unit.**

Shortly before the VIVO H7/H3 shuts down automatically, the display starts counting down the seconds. If you want to keep using the VIVO H7/H3 at this stage, press any button.

If you don't want the power to turn off automatically, change the "AUTO OFF" setting to "OFF" as described on p. 52.

## Demo of the VIVO H7/H3

Your VIVO H7/H3 contains a demo that introduces all the best of its tones.

1. Simultaneously press the [🎹] and [SONG] buttons.



Playback starts automatically with the demo song.

2. Press the [MAIN/EXIT] button to leave the demo function.

**NOTE**

All rights reserved. Unauthorized use of this material for purposes other than private, personal enjoyment is a violation of applicable laws.

# 7 Basic Operation

## About the Display and Cursor Operation

This section introduces the information that appear on the main page. Moreover this section illustrates how to navigate the menu.

### Main Page

The VIVO H7/H3 main page contains many useful information.

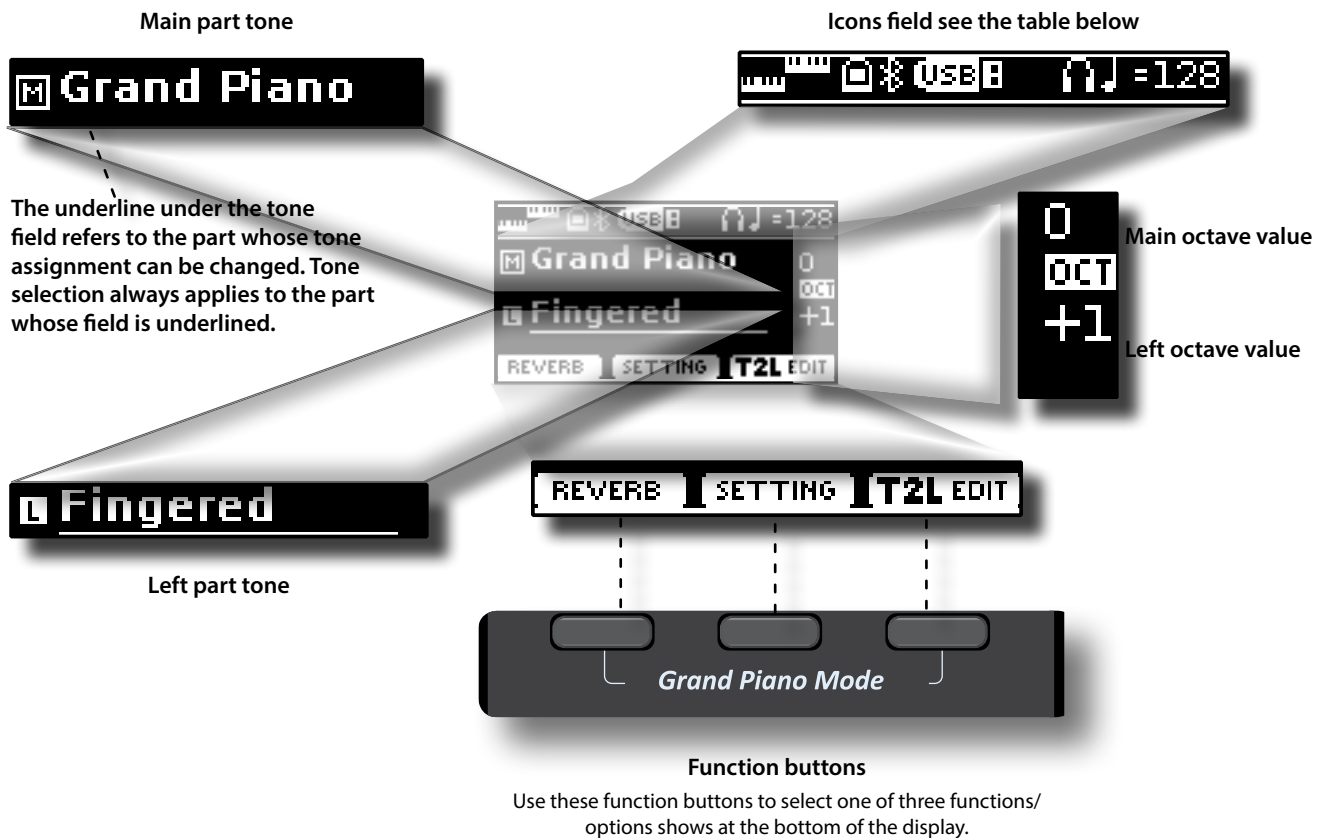

Icons Field	Explanation	Icons Field	Explanation
	Keyboard Mode:		A USB memory is connected to your unit
	• Split		The internal speakers are switched off. See the parameter "Speaker" (p. 52).
	• Layer		An headphone is plugged into the PHONES output jack
	A computer is connected to the VIVO H7/H3's USB "COMPUTER" port		Tempo setting value
	Bluetooth indicator • Steady icon: Connected to a device • Blinking icon: Connecting to a device		

## Moving the cursor and setting parameter values

1. Press the [MENU/EXIT] button to access to the available function groups.

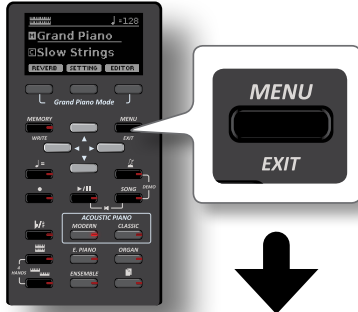

2. Use the [▲] [▼] buttons to select the desired function group.

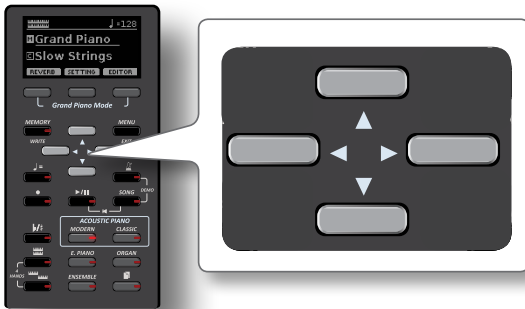

3. Press the [▶] button to enter in the selected function group.



4. Use the [▲] [▼] buttons to scroll the list of parameters. The selected parameter field is underlined.
5. Use the [◀] [▶] buttons to set the desired value.
6. Press the [MAIN/EXIT] button to return to the main page.

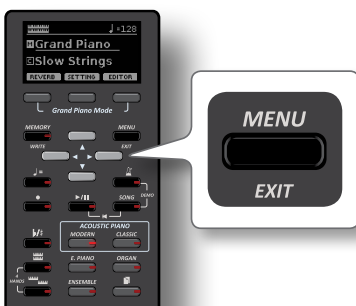

## Assigning the Name You Specify

In many cases you'll have to assign a name to a file. In the following example, we will learn how to give a Memory name.

After the selection of saving a Memory, the display looks as follows:



A Memory name is suggested by the VIVO H7/H3.

1. Use the [▲][▼] buttons to select a different character.
2. Use the [◀] [▶] buttons to select the next character position you want to change, then use the [▲][▼] buttons again.
3. You can press the [A/a/#] Function button to switch between upper- and lower-case characters as well as numbers.

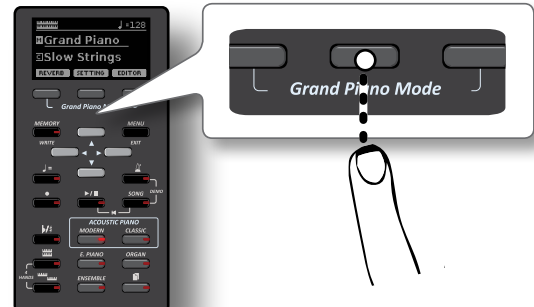

4. To delete the selected character, simultaneously press the central and right Function button.

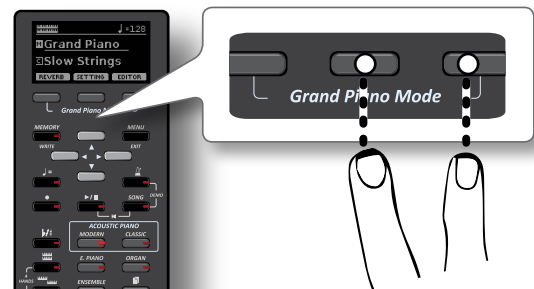

5. To insert a character, simultaneously At the same press the left and central Function button.

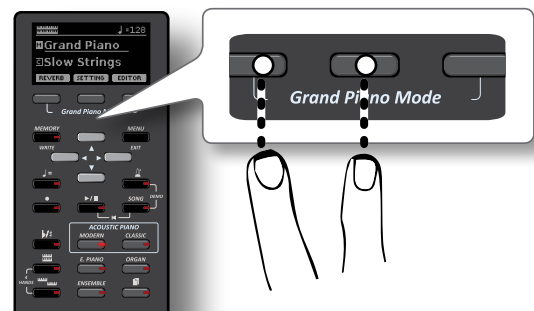

6. Repeat steps (2) and (3) to complete the name.

# 8 Selecting Tones

VIVO H7/H3 has a wide selection of high quality tones arranged in six categories. In particular, thanks to new sound engine, the Piano tones are faithfully reproduced with all the subtle nuances of a real acoustic piano. The VIVO H7/H3 allows you to assign any of the available tones to any of the three real-time parts. Tone selection always applies to the part (Main, Coupled or Lower) whose field is currently underlined in the main page.

## Grand Piano Mode

**NOTE**

At power-on, the instrument is automatically selected in Grand Piano Mode.

1. From the Main page, simultaneously press the first and last Function button.

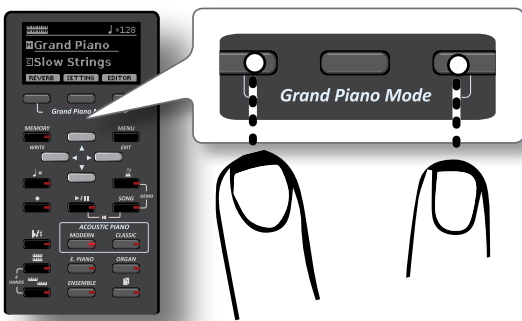

The "Grand Piano" tone is called and all various parameters are modified to play the best piano sound.

2. Play the keyboard to enjoy the piano sound.

All keyboard play piano sound.

Main Part



In the example was pressed [MODERN] button.

2. While the tone window is active, use the [▲][▼] buttons to select a tone in the same category.

If during normal operation the window closes automatically, press the Tone button again.

See page 55 for a list of available Tones.

3. Play the keyboard.

You'll hear the sound of the selected instrument.

**MEMO**

The last sound you select in each category is memorized temporarily and will be recalled every time you press the corresponding Tone button

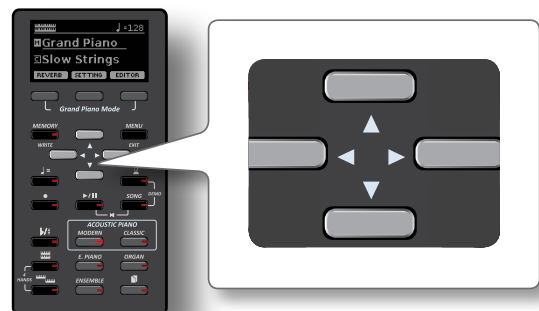

4. While the tone window is active, press the [◀][▶] buttons to select the previous or next tone category or press another desiderate tone buttons.

After few seconds of inactivity of the change tone operation, the Main page is shown.

**TIPS**

A quick way to change a tone from the Main page: use the [▲][▼] buttons to select a next or previous tone in the same category.

## How to Select Tones

1. Press the desiderate Tone button to select the sound category that you want to play.

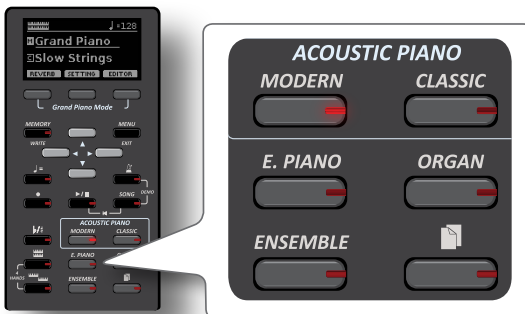

The last sound you selected for that category is recalled.

The button indicator lights and a temporary window shows the list of tones where the recalled sound is underlined:



## Most Frequently Used Tones (Favorite Tone)

The "Favorite Tone" function lets you an easy recall of most frequently used sounds. You can memorize your Favorite Tone for each of six categories and recall it simply pressing the tone button. It will be helpful in a live performance situation.

1. Select a tone you prefer. See "Selecting Tones" (p. 22).
2. Press and hold the Tone button that contains the selected tone to memorize it.



The display shows a confirmation message.

The position of the sound you selected is memorized and will be

## Playing Two Sounds Over the Entire keyboard (Layer)

recalled every time you press the corresponding Tone button.  
The instrument will remember your choice at the next power on.

### Playing Two Sounds Over the Entire keyboard (Layer)

In the previous paragraph "How to Select Tones", you learned how to select a Tone. Below you'll learn how to add a second sound over the entire keyboard.

1. Press the [  ] button to add a second tone (Coupled Part) over the entire keyboard.

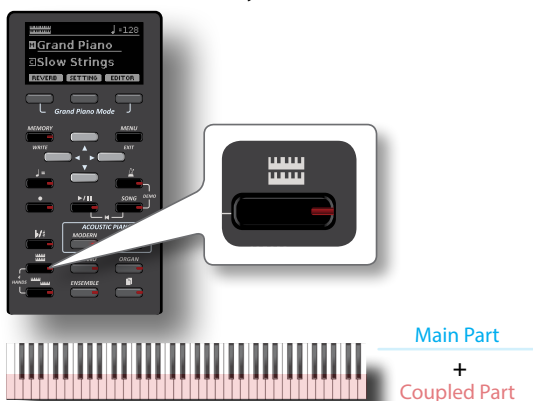

The Coupled part [C] is automatically selected.  
If the main page is displayed shows:



The Coupled part [C] field in the main page is underlined to inform you that the tone selection is applied on this part.

#### NOTE

For Tone selection, it would be a good idea to check on the main page which part is currently selected to ensure that you don't select a Tone for the wrong part.

2. Play the keyboard.  
You'll hear the tones of Main part [M] and Coupled part [C] playing together.
3. To adjust the volume move the VOLUME slider.
4. To change a tone of the Coupled part, see "How to Select Tones" (p. 22).
5. To select the Main part, from the main page, use the [▲] [▼] buttons to select the it.
6. To change a tone of the Main part, see "How to Select Tones" (p. 22).

### Splitting the Keyboard Range and Playing Two Different Tones

Split mode enables you to play two different voices on the keyboard, one with the left hand and another with the right hand.

1. If you want to use your left and right hands to play different Tones, press the [  ] button.



The Keyboard is divided into two sections. The region of the keyboard to the left of the split point becomes the Lower part, while the region of the keyboard to the right of the split point becomes the Main part.



If the main page is displayed shows:



The Lower part [L] field in the main page is underlined to inform you that the tone selection is applied on this part.

2. Play the keyboard.  
Turn the VOLUME knob to adjust the volume.

#### MEMO

The default split point is set between keys E3 and F3. To change the split point see "How to change the Split Point" (p. 23).

#### MEMO

In Split mode, the most suitable octave settings for each tone are applied automatically.

3. To change a tone of the Left part, see "How to Select Tones" (p. 22).
4. To select the Main part, from the main page, use the [▲] [▼] buttons to select the it.
5. To change a tone of the Main part, see "How to Select Tones" (p. 22).

### How to change the Split Point

1. Press and hold the [  ] button until the display shown the following page.



2. Use the [◀] [▶] buttons to change the split point.

Parameter	Setting
Split Point	F1 ~ C#7 Default: F3

- Press the "←" function button to return to the previous page or press [MAIN/EXIT] button to go directly to the main page.

## Mute the Lower Part

Use this function to mute the Lower part. This function can be useful when you want to play only an external device connected via MIDI.



- From the SPLIT page, press the "MUTE ON" Function button.

The note played on the Lower part don't produce sound.

The name of Function button change in "MUTE OFF"



- Press again the "MUTE OFF" Function to exit from mute function.



# 9 Additional Sound -

## Sound Library

VIVO H7/H3 give you the possibility to install new sounds from:

- ❑ DEXIBELL Official Sounds (.DXS extension)

These sounds will be available and downloadable from the following website:

<http://www.dexibell.com/>

*Stay tuned for new sounds and updates by visiting our website regularly!*

- ❑ third-party sounds (.SF2 extension)

You can easily find in the web many sounds library with .SF2 extension. VIVO H7/H3 is compatible with these types of sounds.



### MEMO

VIVO H7/H3 shows the sounds contained in the USB Memory's "\SOUND" folder.

- Use the [▼] [▲] buttons to select the sound library you prefer.
- To open the sound library, press the "OPEN" function button or the [▶] button.



The sound/sounds contained in the library are displayed.

- Use the [▼] [▲] buttons to select the sound you want to listen.
- Play the keyboard.  
You'll hear the sound selected in the library.

## Importing the sound library

If the sound is to your liking, you can import the library into the internal memory.

- Press the "IMPORT ALL" Function button to import the sound library.  
A confirmation message informs you that the sound library has been imported.

## Importing USER Sound Library

You can import sounds library in the internal memory of VIVO H7/H3 and use them in your performances. To import you need an USB Memory and your Personal computer.

### Loading a sounds library in the USB Memory

- Using your computer, download the new sound library from the DEXIBELL web site (.DXS) or from any other web site (.SF2).
- Create a folder "SOUND" in the root of the USB Memory.
- Copy the sound library (.DXS/.SF2) into the USB Memory's "/SOUND" folder.
- Insert the USB Memory into the VIVO H7/H3 USB port. See "Connecting an USB Memory (commercially available)" (p. 18).

### Listening to the sound library before to import it

- Press the [MENU/EXIT] button and use the [▼] [▲] buttons to select the "SOUND LIBRARY" function group.



- Press the [▶] button to display the sound libraries in VIVO H7/H3 internal memory.



The above example shows that no library was loaded.

### NOTE

If the sound library exceeds the size of the internal memory, the "Space not available!" message is showed.

- Press the "USB" function button to list the sound libraries in the USB Memory.

## How to Select USER Sound

- Press the  button.

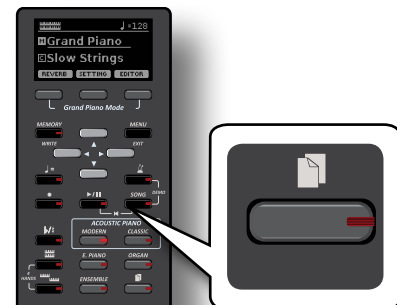

The last sound you selected is recalled.

The button indicator lights and a temporary window shows the list of User tones where the recalled sound is underlined:

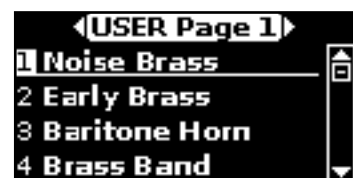

2. While the tone window is active, use the [▲] [▼] buttons to select a User sound.

If during normal operation the window closes automatically, press the Tone button again.

#### TIPS

A quick way to change a tone from the Main page: use the [▼] [▲] buttons to select a next or previous sound in the same category.

## Deleting USER Sound Library

1. Press the [MENU/EXIT] button and use the [▼] [▲] buttons to scroll the cursor and select the "SOUND LIBRARY" function group.
2. Press the [▶] button to display the sound libraries in VIVO H7/H3 internal memory.



3. Use the [▼] [▲] buttons to select the sound library that you want to delete.
4. Use the [DELETE] Function button to delete the sound library selected.

A confirmation message informs you that the sound library has been deleted.

# 10 Four Hands Mode



This function divides the keyboard into two sections, left and right zone, so that two people can play the same range of pitches, just as though there were two pianos.

When this mode is active, it is as if you had two separate 44-keys pianos with the same playing range and octave.

The right pedal act as damper pedal for the right piano section.

The left pedal must be assigned as damper pedal for the left piano section (see below).

## Entering in "4 Hands" mode

1. To enter in "4 hands" mode, simultaneously press the [  ] and [  ] button.

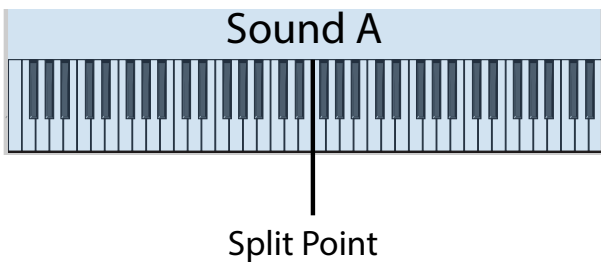

The instrument is now in the "4 Hands" mode.

**NOTE**

The default four hands mode split point is set between keys B3 and C4.

## Assigning the damper for the left piano section.

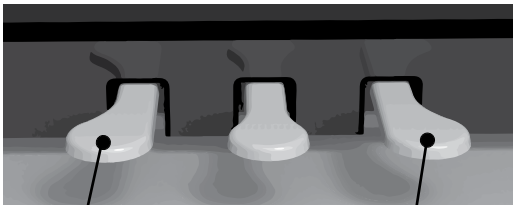

To assign left pedal as damper for the left section, please follow the next instructions.



Damper pedal for the left section.

See below how to assign it.

Damper pedal for the right section

2. To enter in "4 hands" settings, press and hold the [  ] and [  ] button until the following page is displayed.

The display shows the "4 HANDS MODE" page:





3. By the [▲] [▼] buttons select the "Left Damper" parameter and press the [▶] button to set it "ON".

**TIPS**

The VIVO H7/H3's settings will revert to the default values when you turn off the power. It is a good idea memorize this settings in the Internal Memory. Please refer to "Saving Your Settings in the Internal Memory" (p. 38). To restore your situation, please

see "Recalling your Settings from Internal Memory" (p. 38).

Now you are ready to have a four hand performance.

4. To leave the "4 hands" mode, simultaneously press the [  ] and [  ] button.

## How to adjust the volume balance between the Left and Right Piano Section

In the "4 HANDS MODE" page you can adjust the "Balance" and "Output" parameters.



5. Use the [▲] [▼] buttons select the parameter that you want adjust.

6. Use the [◀] [▶] buttons to set the desired value.

Parameter	Setting	Explanation
Balance	90:10 ~ 50:50 ~ 10:90	Adjust the balance between the Left and Right piano section.
Output	<L R>, L&R	Select the audio signal output socket.  <LR>: The sound of the Left piano section will be heard only from the left speakers. The sound of the Right piano section will be heard only from the right speakers.  L&R: The sound of the Left and Right piano section will be heard from both speakers (Left and Right).  <b>NOTE</b> If using headphones, you have the same behavior of speakers.

# 11 Sound Effects

## Going Around Sound Effects

VIVO H7/H3 is quite simply a superlative instrument with the most advanced and best sound generation technology Dexibell has to offer. When you recall a Tone the instrument automatically add the appropriate effects for that sound.

Anyway, VIVO H7/H3 give you the possibility to change type of effect or modify some parameter of it.

VIVO H7/H3 manage two units of effectors (FX-A and FX-B) for each keyboard part (Main, Lower, Coupled).

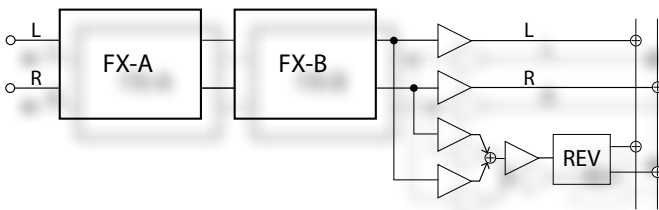

1. To access the "EFFECTS" page, press the [MENU] button and select the page using [▲], [▼] and [▶] button.

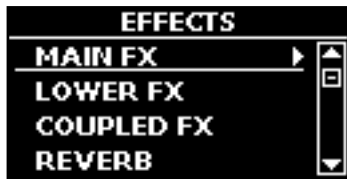

2. Select one of FX page relative to the keyboard part ("MAIN FX", "LOWER FX" and "COUPLED FX").



In the example we selected the "MAIN FX" page.

3. Use the [◀] [▶] buttons to choose the Type of effect. Press the "FX-A OFF" Function button if you don't need the FX processor. For the list of effects see "Effects Types and Parameters List" (p. 53).
4. Use the [▲] [▼] buttons to select the parameter relative to the chosen effect.
5. Use the [◀] [▶] buttons to adjust the parameter value. For details about the parameters for each effects, see p. "Effects Types and Parameters List" (p. 53).
6. To edit the second FX processor, press the "FX-B" Function button.

## Adding Reverb to the Sound

The reverb enables you to select various digital reverb effects that would add extra depth and expression to the sound to create a realistic acoustic ambience.

1. While the main page is displayed, press the left Function button to access the Reverb parameters.



The display shows the Reverb page:



### MEMO

You can also select this function pressing [MENU] button → EFFECTS → REVERB.

2. Use the [▲] [▼] buttons to specify the part you wish to change the Reverb level.
3. Use the [◀] [▶] buttons to adjust the Reverb level.

## Changing the Reverb Type

This parameter allows you to specify what kind of reverb effect you need.

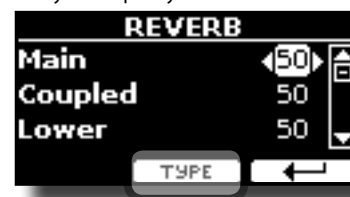

1. While the Reverb page is displayed, press the "TYPE" Function button to access the Reverb Type page.



2. Use the [◀] [▶] buttons to choose the Macro Type you prefer.

The available Macro reverb types are:

### Setting

Hall, Dark Hall, Mid Hall, Concert Hall, Large Hall, Chathedral, Arena, Cave, Chamber, Room, Venue, Ambience, Wooden Room, Brick Room, Studio Booth, Small Room, Living Room, Office, Warehouse, Music Club, Plate, Small Spring, Bright Spring, AmpSpring

# 12 Personalizing Your Sounds

## T2L-Modelling



The revolutionary technology found on all models of DEXIBELL digital Pianos.

T2L-Modelling is the combination of innovative technologies developed to achieve maximum timbre accuracy and precise sound responsiveness to the multiple articulations of a pianist.

T2L modelling has many algorithms that simulate all the characteristics of an acoustic piano. It take care of many aspect as:

### No Damper ("No Damper" on high notes)

The last 18 higher notes, like in the acoustic instrument, do not have the presence of the dampers and then are free to vibrate even when keys are released.

The duration of these notes, playing in staccato mode, is much longer than the previous notes that instead have the presence of the damper

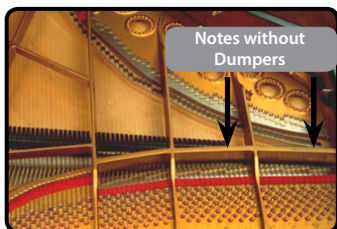

### FP-Simulation ("Forte Pedal" multi actions simulation)

The "Forte" Pedal (Sustain), performs several actions that are simulated through this function.

A) When the "Forte" pedal is pressed, a sound is generated to simulate the damper friction noises of felts when releasing from the strings (Dumper Friction Noise).

B) Pressing the "Forte" pedal, the active notes will be enriched with resonances produced by all strings free to vibrate, thanks to the raised dampers (Strings Resonance). The result of the Strings Resonance makes the sound of a sustained note by the use of the "Forte" pedal substantially different from the sound of a just held note.

C) When the "Forte" pedal is released, a noise is simulated like the mechanical noise in the acoustic instrument (Sustain Pedal Mechanical Noise)

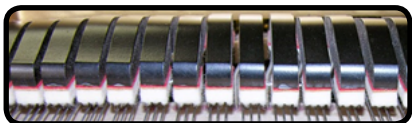

(A) & (B) "Forte" pedal is pressed, felt dampers are raised

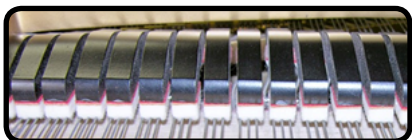

(C) "Forte" pedal is released, felt dampers are resting on strings

### SP-Simulation ("Soft Pedal" Simulation)

The "Soft" Pedal, acts a change of volume and timbre color of the sound, simulating the "soft" function on the acoustic piano.



Soft Pedal

## T2L Sound Parameters

VIVO H7/H3 allows you to personalize the tones of your Piano keyboard by adjusting various factors that affect the sound.

Each Tone has available a number of parameters that allow you to personalize the sound.. Below, you'll find an example of some parameters characterizing the piano sound.

### Hammer-Noises (Key On impulsive Noises)

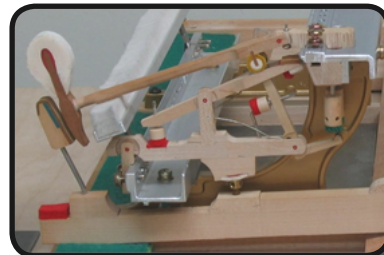

Attack of notes contains an impulsive portion of sound produced by the hit of the Hammer to the strings, amplified and sustained by the resonance of the piano body. A function is available to reduce/increment this element of the sounds.

### Key Off Noise (Key Off Mechanical Noises)

The release of keys causes mechanical noises proportional to the speed of the release itself. This behavior of the acoustic instrument is reproduced by this function.

### Damper Noise

This is the typical noise of an acoustic piano when the pedal sustain is pressed (lift all dampers) or released (lower all dampers).

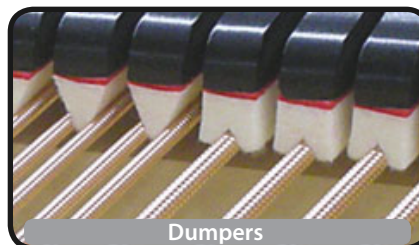

Dampers

### String Reso (Sympathetic Harmonic Resonances)

As in the acoustic Piano, while holding down some keys and playing other notes in staccato mode, a multitude of additional harmonics can be listened, thanks to "sympathetic resonance" generated by the free to vibrate strings (due to raised dampers) of the held notes.

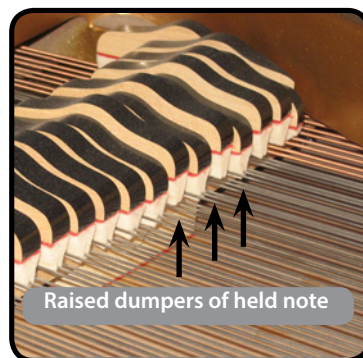

Raised dampers of held note

### Damper Reso

It's the typical noise generated by the free to vibrate strings (all damper raised) when the damper pedal is pressed.

### Cabinet Reso (for Electric Piano)

Thanks to this parameter you can increase or decrease the cabinet resonance.

### Bell (for Electric Piano)

The "bell sound" is characteristic of some electric pianos that became particularly popular throughout the 1970s.

You can adjust the quantity of this typical sound.

### Click (for Vintage Organ)

The key click is typical of vintage organs. It's a electrical pop which was the result of the keys making contact. It was considered a defect, there were all kinds of efforts to reduce it, but it never could be eliminated. Meanwhile it has become a characteristic "click" for rock and modern musicians.

You can adjust quantity of click sound when press and release a key.

### Growl (for Electric Piano)

This is a typical distortion of the sound during the phase attack that give a "growling" effect. Thank to this parameter you can increase or decrease the effect.

### Off Noise (for Clavinet, Harpsy, Church Organ)

You can adjust the quantity of the noise effect that some instrument produce when the key is released.

### Percussion (Vintage Organ)

Not to be confused with the key click of pop organ. The percussion was introduced with the advent of electronic organs to emulate the percussive sounds of the harp, xylophone and marimba.

The percussion is a typical register in the upper manual. This parameter adjust the quantity of percussive sound.

### Attack, Hold, Decay, Sustain and Release

These parameters characterize the envelope of the sound. When a pipe organ's key is pressed, for example, it plays a note at constant volume; the sound dies quickly when the key is released. By contrast, the sound of a guitar is loudest immediately after a string is plucked, and quickly fades. Try to change the envelop of a sound by these parameters.

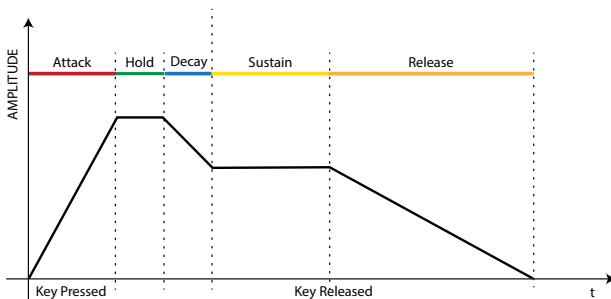

### Ride

This parameter increase or decrease the volume of Ride Cymbals sound contained in the "Ac. Bass&Ride" tone.

## Making Slight Additions or Sound Alterations

Although Dexibell sound are developed to achieve the maximum sound accuracy, you can necessity to modify them at your taste them or create new sonority.

1. Select the sound that you want personalize.
2. From the main page press the "T2L" Function button to access the Editor function.

#### MEMO

You can also select this function pressing [MENU] button → T2L EDITOR.



The display shows the Editor sound page that contains all possible parameters for the tone you selected:

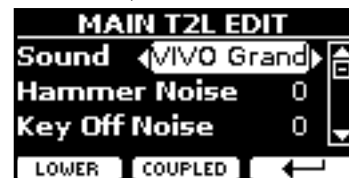

In the example above the VIVO Grand piano was selected.

3. Use the [▲] [▼] buttons to select the parameter you wish to modify.
4. Use the [◀] [▶] buttons to adjust the value.
5. To modify a tone in the LOWER or COUPLED part press the relative Function button.

## Saving your changing

All you need to do is to save your setting in a memory. See "Working with the Memories" (p. 38).

# 13 Other Functions

## Transposing the pitch of the keyboard

The Transpose setting allows the pitch of your digital piano keyboard to be raised or lowered in semi-tone steps.

This is particularly useful when accompanying instruments tuned for different keys, or when a song learned in one key must be played in another key or when a singer sing in a key different than the original music.

1. Press the [b/#] button.

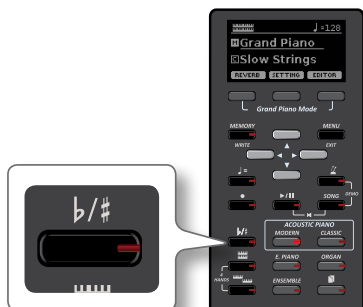

The display shown the following page.



2. Use the [◀] [▶] buttons to adjust the transposition value.

### "Transpose" setting

-12 ~ 0 ~ +12 (semitone units)

If you set a value different than 0, the [b/#] button indicator lights and the keyboard is transposed.

### MEMO

You can also select this parameter pressing [MENU] button SETTING→TRANPOSE.

## Shifting the Tuning of a Keyboard Part in Octave Steps

The Octave function is an useful parameter that allows you to change the pitch of the selected part in octave steps (12 semitones at a time).



1. From the Main page, press the "SETTING" Function button to access the MAIN SETTING page.



The Main setting page can be also selected using [MENU] button →SETTINGS→MAIN SETTING.

2. Use the [▲] [▼] buttons to select the "Octave" parameter.
3. Use the [◀] [▶] buttons to set the desiderate octave for the Main part.  
In this page you can also adjust the audio level and mute the part. For details see the "MENU Options (Advanced Section)".
4. To change the Octave of another keyboard part, press the function button related to the part.

## Practicing with the Metronome

The metronome provide a steady tempo to aid practicing the piano at a consistent tempo.

1. Press the [metronome] button.

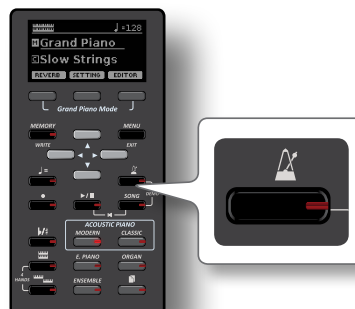

The [metronome] button will blink, and the metronome will sound. To change the Tempo value see "How to Adjust the Tempo Value" (p. 32).

2. To stop the metronome, press the [metronome] button once again.

The [metronome] button indicator turn the lights off.

## Metronome Settings

The VIVO H7/H3 also allows you to specify when and how the metronome should sound:

1. Press and hold the [metronome] button until the display shown the following page.



The metronome settings can be also selected using [MENU] button

→TEMPO→METRONOME.

- Use the [▲] [▼] buttons to select the parameter.
- Use the [◀] [▶] buttons to adjust the value.

The metronome parameters you can set are:

Parameter	Setting	Explanation
Volume	Mute, 1~100	Sets the metronome's level.
Downbeat	OFF, ON	Select "ON" to activate the downbeat (the first beat of a measure in music) sound. Default: ON
Click		Specifies the metronome's resolution.

- To mute the sound of Metronome press the "MUTE ON" Function button.

Press again to activate it again.

**MEMO**

The settings can be saved to the VIVO H7/H3's global memory.

preset tempo.



The Tempo indication are the following:

Parameter	Setting	Assigned Tempo Value
Preset Tempo	GRAVE,	40
	LARGO,	45
	LARGHETTO,	49
	LENTO,	51
	ADAGIO,	57
	ANDANTE,	61
	ANDANTINO,	71
	MODERATO,	81
	ALLEGRO,	101
	ALLEGRETTO,	113
	VIVACE,	127
PRESTO,	145	
PRESTISSIMO	181	

## How to Adjust the Tempo Value

You can modify the tempo of metronome.

**MEMO**

You can also use the TAP TEMPO function to set the desired tempo. See "Use Tap Tempo Function to set the Tempo Value" here below.

- Press the [♪=] button.



The following page is shown:



The metronome settings can be also selected using [MENU] button →TEMPO→TEMPO\_TAP.

- Use the [◀] [▶] buttons to adjust the tempo value.

Parameter	Setting
	20 ~ 300

- In the same display page you can set the tempo using the Tempo indication. The tempo indication is typically written at the start of the score. Use the [▲] [▼] to select the tempo indication and use [◀] [▶] buttons to select a

## Half and Double

- Use the [HALF] or [DOUBLE] Function buttons to to halve or double the tempo value.

## Use Tap Tempo Function to set the Tempo Value

- Press the [♪=] button at least three times at the desired tempo.

The instrument calculates the intervals between your presses and sets the corresponding tempo value.

## Setting the Metronome Time Signature

The time signature is a notational convention to specify how many beats are to be contained in each bar and which note value is to be given one beat. In a musical score, the time signature appears at the beginning of the piece.

- From the TEMPO/TAP page, use the [▲] [▼] and [◀] [▶] buttons to change the Time Signature value.



Parameter	Setting
Time Signature	1/16 ~ 32/16,
	1/8 ~ 32/8,
	1/4 ~ 32/4,
	1/2 ~ 32/2

**MEMO**

The settings can be saved to the VIVO H7/H3's global memory.



### Adjusting the Keyboard Response (Key Touch)

If the keyboard response don't meet your taste, you can adjust it. You can choose until to four dynamic response.

1. Press [MENU/EXIT] button and select SETTING→KEYBOARD TOUCH function using the [▲], [▼] and [▶] buttons. See "Moving the cursor and setting parameter values" (p. 21).

The following page is shown.



2. Use the [◀] [▶] buttons to choose your desiderate dynamic response.

The following settings are available:

Setting	Value	Explanation
Keyboard Touch	Light++	"Heavy" range: Select this setting for maximum expressiveness. Even small variations of the force with which you strike a key produce audible changes. The trade-off is, however, that you have to strike the keys forcefully to reach the maximum volume.
	Light+	
	Light	"Normal": Medium velocity sensitivity. The keyboard responds to velocity changes, but the maximum volume can be obtained more easily than with "Hard".
	Normal	
	Heavy	"Light" range: Select this settings if you are used to playing on an electronic organ or if you do not want velocity changes to bring about major volume changes.
	Heavy+	
Heavy++	"Fixed": Select this setting if all notes you play on the keyboard should have the same velocity value. When you set this parameter, the "Fixed value" field can be edited.	
Fixed [1~127]		
*Fixed Value	1~127	Allows you to set the value when "Curve" is set to "Fixed".

[\*] This parameter can only be edited if the "Keyboard Touch" parameter is set to "Fixed".

### Adjusting the AUDIO IN Input Level

The input level of the audio source you connect can be set with the "AUDIO INPUT Level" parameter.

1. Press [MENU/EXIT] button and select SETTING→AUDIO INPUT function using the [▲], [▼] and [▶] buttons. See "Moving the cursor and setting parameter values" (p. 21).

The following page is shown.



2. Use the [◀] [▶] buttons to adjust your desiderate the AUDIO IN level.

### Master Equalizer

The equalizer give you the possibility to boosting or reducing the low-frequency or high-frequency range of the sound. Adjust the Master EQ parameters to reach the best possible sound when listening through different reproduction systems, headphones, or an external speaker system.

1. Press [MENU/EXIT] button and select EFFECTS→MASTER EQ



1. Use the [▲], [▼] buttons to select the parameter and use the [◀] [▶] buttons to adjust the value.

Parameter	Setting	Explanation
High Gain	-12~ 0 +12 dB	Use this parameter to set the level of the high frequency. Positive values boost (increase the volume of) that frequency. Negative values cut (attenuate) it.
Mid Freq	200 ~ 8000 Hz	This parameter allows you to set the cutoff frequency of the middle band.
Mid Gain	-12~ 0 +12 dB	Use this parameter to set the level of the selected MID frequency. Positive values boost (increase the volume of) that frequency. Negative values cut (attenuate) it.
Low Gain	-12~ 0 +12 dB	Use this parameter to set the level of the low frequency. Positive values boost (increase the volume of) that frequency. Negative values cut (attenuate) it.

### Master Equalizer Preset

VIVO H7/H3 comes with some Presets that can be handy in particular situations or a good way to get you started. You might want to start with a preset, then customize it until it is just right and save it in the user area.

1. From the "MASTER EQ" page press the "PRESET" Function button.



2. Use the [▲], [▼] buttons to select the desired preset.
3. Press the "SELECT" Function button to confirm your choice.

Its "EQ" icon is highlighted to indicate that the preset has been loaded.

## Saving Your User Preset

Make the necessary adjustments to obtain the sound that suits you best.

1. From the "MASTER EQ" page, press the "SAVE" Function button.



2. If you wish, you can give a name to the preset pressing the "RENAME" Function button. For details how to rename see "Assigning the Name You Specify" (p. 21).
3. Press the "WRITE" Function button to save your preset. The display shows a confirmation message.
- 4.

## Restoring the Factory Settings (Factory Reset)

The following function allows you to recall the VIVO H7/H3's original factory settings.

### WARNING

All data will be deleted. Backup your own settings to an USB memory.

1. Press [MENU/EXIT] button and select FACTORY RESET function using the [▲], [▼] and [▶] buttons. See "Moving the cursor and setting parameter values" (p. 21).

The display shows the following window.



2. Press the "YES" Function button proceed.

The message "Complete" informs you that the VIVO H7/H3 has been initialized.

### NOTE

The Factory Reset function doesn't initialize the Global Area.

# 14 Practice with Song Player

This section explains how to playback audio songs stored in the internal memory or in the USB Memory (commercially available).

You can practice playing along backing song.

VIVO H7/H3 play back the following file types:

File Type	Extension
Audio files	.mp3
	.wav
	.aiff or .aif

## Playing a Song

### Loading a Song

1. Press the [SONG] button. Its indicator lights.



The display shows the Song main page and the name of the current song is shown if already loaded.



2. Press the "SONG LIST" function button. The display shows the contents of the Song internal memory.



### Loading from Song Internal Memory

- a. Use the [▲][▼] buttons to scroll through the files to choose the song to load.
- b. Press the "SELECT" Function button to load the song you want to practice.

### Loading from USB Memory

- a. Insert a USB Memory that contains songs. See "Connecting an USB Memory (commercially available)"

(p. 18).

- b. To list the USB Memory contents, press the "USB" Function button.

The display shows the contents of the USB Memory.



- c. Use the [▲][▼] buttons to scroll through files and folders.
- d. If the song you need is located inside a folder, you must first select that folder, press the "OPEN" Function button to see its contents and then select the song. If you opened a folder by mistake, press the "←" Function button to return to a higher level.
- e. Press the "SELECT" Function button to load the song you want to practice. The song icon is highlighted to indicate the song selected.

### Playing the loaded song

3. Press the [▶/||] button.  
The [▶/||] button's indicator lights and song playback starts..
4. Press the [▶/||] button again to pause song playback.  
The [▶/||] button goes dark.
5. To return to the beginning of the song, simultaneously press the [||/◀] and [SONG] buttons
6. Press [▶/||] yet again to resume playback.

### Useful Song Controls

VIVO H7/H3 has useful song controls that allow you to adjust the volume, rewind or fast-forward within the currently selected song, etc.

1. Load the song you want to play back. See "Playing a Song" (p. 35).

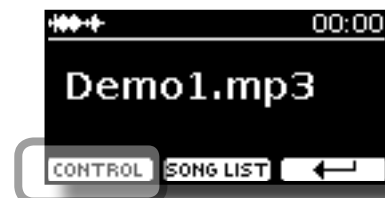

2. From the Song main page, press the "CONTROL" Function button.

The display shows:



3. Use the [▲][▼] buttons select the control parameter.
4. Use the [◀][▶] buttons to choose your setting.

Parameter	Value	Explanation
Volume	0~127	Adjust the Volume of the song player
Time	It depends on the duration of the song	<ul style="list-style-type: none"> <li>• Press the [◀] to rewind within the song</li> <li>• Press the [▶] to fast-forward within the song</li> </ul>
Loop Mode	OFF, ON	"ON": The playback of current song is repeated until select a different song or stop the song playback.

# 15 Recording Your Performance

Your digital piano allows you to record your performance and save it internally or to a USB storage device.

Record and play back what you've played on the instrument can be an effective practice aid.

## Recording as Audio Data

Your performance will be recorded as audio data. The recorded song can be used on your computer, phone and in any audio player.

### NOTE

To use this method of recording, you must connect a USB drive (sold separately) to the USB Memory port (p. 18).

## Recording Your Music as audio data (WAVE).

This useful function allows professional quality stereo recordings.

You can reproduce directly by a portable music players by using a computer.

Recording are saved in the external USB Memory (commercially available).

In addition, the VIVO H7/H3 digital piano allows you to record everything is connected to the AUDIO IN socket. You can reproduce a backing audio track by external player connected to the AUDIO IN socket, play your piano along to in order to practice and then record your performance.

### NOTE

- You will need a USB Memory (commercially available) to record your performance.

## Audio Recorder format specifications

Audio Format	Specification
WAV	48 kHz, 32 bit, Stereo

## Before you start recording

1. Connect the USB Memory to which you wish to save the audio data. See "Connecting an USB Memory (commercially available)" (p. 18).
2. Prepare everything you want to record: select the tone and the keyboard mode that you want to use for performing. See "Selecting Tones" (p. 22).
3. If desired, sound the metronome. See "Practicing with the Metronome" (p. 31).

### MEMO

The metronome signal is not recorded.

## Starting/stopping recording

4. Press the [●] (Rec) button to start recording.  
The indicator of the [●] button lights and the VIVO H7/H3 starts to recording everything you play on the keyboard.
5. At the end of the song, press the [●] (Rec) button to stop recording.  
The recording stop and the display shows a confirmation message. Your audio file is saved to the "Recording" folder on the USB

memory.

### NOTE

Do not disconnect the USB Memory during the song recording or before the confirmation message is shown at the end of recording.

## About the Recording Files

The audio file are saved in the "Recording" folder on the USB Memory.

If the "Recording" folder doesn't exist, it is automatically created at the first recording.

The song are saved with a different progressive number: rec\_0001.wav, rec\_0002.wav and so on.

## Listening to your recording

6. Press the [▶/||] button to listen your song.

If you want to re-record again, repeat from step 4.

### NOTE

You should always safely eject the USB Memory before physically unplugging it from USB socket. Before to unplug the USB Memory use the "USB REMOVE" function. See "Safely Remove the USB Memory" (p. 18).

## How to Record your Performance over an Existing Audio Base (Overdub)

This is a technique used in audio recording. While listening to an existing recorded audio base, play a new performance along with it. All is recorded in a new song.

1. Connect the USB Memory to which you wish to save the audio data. See "Connecting an USB Memory (commercially available)" (p. 18).
2. Prepare everything you want to record: select the tone and the keyboard mode that you want to use for performing. See "Selecting Tones" (p. 22).
3. Load a existing audio base. See "Loading a Song" (p. 35).
4. Press the [●] (Rec) button to start recording.
5. Press the [▶/||] button to start the playback of the audio base as background.
6. Play your performance while listen the audio base.
7. At the end of song, press the [●] (Rec) button to stop recording.  
The recording stop and the display shows a confirmation message.
8. Press the [▶/||] button to listen your song.

# 16 Working with the Memories

Using the Memories is a lot faster than calling up one of the VIVO H7/H3's functions, modifying the settings, etc., while playing.

VIVO H7/H3 provides 20 Memories that allow you to store almost all settings (or registrations) you make on the front panel and the various display pages. Additional Memories can be imported directly from a USB Memory.

## About the Memories and Memory Set structure.

The Memories you create are saved in the internal Memory Set or in an external Memory Set previously saved in the USB Memory. This allows you to prepare one set of Memories for weddings, another for corporate events, a third for anniversaries, etc.

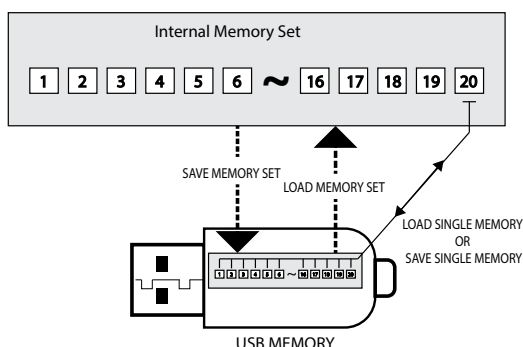

## Saving Your Settings in the Internal Memory

1. Change all settings the way you want to save them.  
For details on settings memorized, see p. 45.
2. Press and hold the [MEMORY/WRITE] button until the display shows:



The [MEMORY/WRITE] button indicator flashes and the list of Internal Memory is shown.

### MEMO

You can also select this function pressing [MENU] button →MEMORY→WRITE.

3. Use the [▲][▼] buttons to move the cursor inside the list in the position you want to replace the Memory.
4. Press the "SAVE" Function button to confirm.

The display changes to:



5. If you want to name your new Memory, see "Assigning the Name You Specify" (p. 21) for details.

6. Press the "OK" Function button to save the Memory.

The memory will be saved and the list of Internal Memory is shown.



## Recalling your Settings from Internal Memory

1. Press the [MEMORY/WRITE] button.

The [MEMORY/WRITE] button indicator lights steady and the list of Internal Memory is shown.



### MEMO

You can also select this function pressing [MENU] button →MEMORY→RECALL.

2. Use the [▲][▼] buttons to move the cursor inside the list to select the Memory you want to recall.
3. Press the "RECALL" Function button to recall the Memory.  
The Memory is recalled and the display shows the Memory highlighted.



## Saving Your Settings in the USB Memory (commercially available)

1. Connect the USB Memory to which you wish to save the Memory. See "Connecting an USB Memory (commercially available)" (p. 18).
2. Change all settings the way you want to save them.
3. Press and hold the [MEMORY/WRITE] button until the display shows:



The list of Internal Memory is shown.

**MEMO**

You can also select this function pressing [MENU] button → MEMORY → WRITE.

4. Press the [USB] Function button to select the destination memory.

The display shows a list of all files and folders on the USB storage device you have just connected.



Now you can save:

- In a Memory Set previously saved. Continue from step (5)
- In a new Memory Set. See "Saving in the New Memory Set" below.

### Saving in the Memory Set previously saved

5. Use the [▲][▼] buttons to scroll through files and folders to select the Memory Set.

Memory Set Icon	Memory Set file extension
	.rif

Use the "OPEN" Function button if you need to enter in a folder. If you opened a folder by mistake, press the [←] button to return to a higher level.

6. Press the "OPEN" Function button to recall the Memory Set.

The display shows the list of memories in the Memory Set.



7. Use the [▲][▼] buttons to move the cursor inside the list in the position you want to replace the Memory.

8. Press the "SAVE" Function button to confirm.

The display changes to:



9. If you want to name your new Memory, see "Assigning the Name You Specify" (p. 21) for details.

10. Press the "OK" Function button to save the Memory. The memory will be saved and the list of memories is shown.



### Saving in the New Memory Set

1. Press the "NEW SET" Function button to create an empty Memory Set.

This page allows you to create a new Memory Set List whose name is selected automatically by the VIVO H7/H3.



2. If you want to name your new Memory Set, see "Assigning the Name You Specify" (p. 21) for details.

3. Press the "OK" Function button to confirm the name.

The display shows contents of the new Set just created.



4. Use the [▲][▼] buttons to move the cursor inside the list in the position you want to write the Memory.

5. Press the "SAVE" Function to confirm.

The display changes to:



A Memory name is suggested by the VIVO H7/H3.

6. If you want to name your new Memory, see "Assigning the Name You Specify" (p. 21) for details.

7. Press the "OK" Function button to save the Memory.

The memory will be saved and the list of Memories is shown.



## Recalling your settings from an USB Memory

1. Connect an USB memory to the VIVO H7/H3. For details see p. 18.  
A USB icon appears in the Icons field of Main page. See "Main Page" (p. 20).
2. Press the [MEMORY/WRITE] button.  
The [MEMORY/WRITE] button indicator lights steady and the list of Internal Memory is shown.



**MEMO**  
You can also select this function pressing [MENU] button →MEMORY→RECALL.

3. Press the "USB" Function button.  
The display shows a list of all files and folders on the USB storage device you have just connected.



4. Use the [▲][▼] buttons to scroll through files and folders to select the Memory Set.

Memory Set Icon	Memory Set file extension
	.rif

Use the "OPEN" Function Button to enter in a folder.  
If you opened a folder by mistake, press the [←] button to return to a higher level.

5. Press the "OPEN" Function button to open the selected Memory Set.

The display shows the list of Memories:



6. Use the [▲][▼] buttons to move the cursor inside the list to select the Memory you want to recall.
7. Press the "RECALL" Function button to recall the Memory.  
The Memory is recalled and the display shows the Memory highlighted.



**MEMO**  
To display the Internal Memories again, press the "INTERNAL" Function button.

## Renaming a Memory

This function allows you to change the name of a selected Memory.

1. Press the [MENU] button and select MEMORY→RENAME.

The list of Internal Memory is shown:



2. Use the [▲][▼] buttons to move the cursor inside the list in the position you want to rename the Memory.

3. Press the "RENAME" Function button to confirm.

The display changes to:



4. Use the [▲][▼] and the [◀][▶] buttons to rename the Memory. See "Assigning the Name You Specify" (p. 21) for details.

5. Press the "OK" Function button to confirm the name.  
The memory will be renamed and the list of Internal Memory is shown.



## Exporting a Memory Set in the USB Memory

Use this function for exporting the Internal Memory Set in the USB Memory (commercially available).

This function is useful to create special sets for each event and import them at your convenience.

You can also use this function to backup the Internal Memories.

1. Connect an USB memory to the VIVO H7/H3. For details see p. 18.

A USB icon appears in the Icons field of Main page. See "Main Page" (p. 20).



2. Press the [MENU] button and select MEMORY→EXPORT SET.



The display shows a list of all files and folders on the USB storage device you have just connected.



3. Use the [▲][▼] buttons to scroll through folders to select the destination folder.

Use the "OPEN" Function button to enter in a folder.

If you opened a folder by mistake, press the [←] button to return to a higher level.

4. Press the "EXPORT" Function button to confirm your selection.

The display changes to:



A Memory Set name is suggested by the VIVO H7/H3.

5. If you want to name the Memory Set, see "Assigning the Name You Specify" (p. 21) for details.
6. Press the "OK" Function button to export the Memory Set.

A message confirm the operation.

### NOTE

You should always safely eject the USB Memory before physically unplugging it from USB socket. Before to unplug the USB Memory use the "USB REMOVE" function. See "Safely Remove the USB Memory" (p. 18).



3. Use the [▲][▼] buttons to scroll through folders to select the Memory Set to import.



Use the "OPEN" Function button to enter in a folder.

If you opened a folder by mistake, press the [←] button to return to a higher level.

4. Press the "IMPORT" Function button to confirm your selection.

A message confirm that the Memory Set was imported.

### NOTE

Importing from a Memory Set that contains more than 20 memories, only the first 20 memories will be imported.

### NOTE

You should always safely eject the USB Memory before physically unplugging it from USB socket. Before to unplug the USB Memory use the "USB REMOVE" function. See "Safely Remove the USB Memory" (p. 18).

## Importing a Memory Set from the USB Memory.

Use this function for importing Sets from the USB Memory (commercially available) to Internal Memory.

1. Connect an USB memory that contains Memory Sets to the VIVO H7/H3. For details see p. 18.  
A USB icon appears in the Icons field of Main page. See "Main Page" (p. 20).
2. Press the [MENU] button and select MEMORY→IMPORT SET.  
The display shows a list of all files and folders on the USB storage device you have just connected.

# 17 Playing with Audio Backing Tracks

Thanks to X MURE® application and VIVO H7/H3 you can play your favourite melodies while controlling a audio pattern.



X MURE® is a DEXIBELL® software product

## WHAT IS X MURE

- X-MURE is an application that runs on iPhone or iPad.
- Using "Harmony Poly Fragmentor" the world first algorithm able to modify "audio tracks" in real time, "X MURE" allows you to play music directly on the screen of your iPad/iPhone or with a musical instrument connected via USB.
- "X MURE" does not use sound generators, virtual instruments or "Standard MIDI file", it is exclusively based on audio tracks recorded by real musical instruments, so it does not simulates reality... it is the reality.

## WHAT YOU CAN DO WITH X MURE

- Control X MURE audio patterns by live chord progression played by VIVO H7/H3.
- Re--arrange your favourite music tracks using countless musical genres or create a completely new song hit.

## WHAT YOU NEED TO USE X MURE

- VIVO H7/H3 Digital Piano.
- Apple iPad Camera Connection Kit (Camera connectors made by Apple Inc.).
- USB cable (type A--male - type B--male: commercially available).
- Audio cable (3.5 mm jacks).
- Download X MURE application from App Store.

2. Rotate the [VOLUME] knob toward the lower position to minimize the volume.
3. Connect the VIVO H7/H3's INPUT jack positioned to the left front bottom panel to the output of your mobile device. See "Connecting Digital Player devices" (p. 17).

## Playing with X MURE Application

1. Turn your VIVO H7/H3 and your iPad on.
2. Touch the X MURE icon in your iPad to open the app.

Now you have three possible choices:



3. Touch Dexibell VIVO icon to have the maximum performance with VIVO H7/H3.

The following page appears:

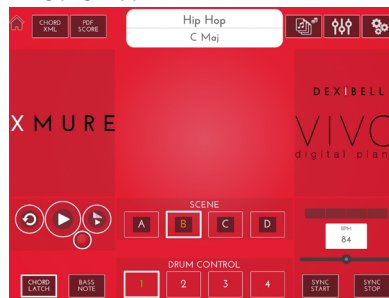

4. Play a note in the keyboard to inform X MURE which part you want use to control it.
5. On X MURE select the audio pattern you want play back.
6. Touch the play icon of the X MURE application.

The pattern start to play back.

### MEMO

You can use a pedal to Play or Stop the play back of the pattern. See "CENTRAL PEDAL" or "LEFT PEDAL" (p. 48).

7. Play chords in the keyboard. The audio pattern follows your chord progression.
8. On X MURE touch the "A", "B", "C", "D" icon button to chose a different scene.

### MEMO

You can use a pedal to select different scene. See "CENTRAL PEDAL" or "LEFT PEDAL" (p. 48).

9. On X MURE touch the "1", "2", "3", "4" icon button to chose a different drum pattern.

### MEMO

You can use a pedal to select different drum pattern. See "CENTRAL PEDAL" or "LEFT PEDAL" (p. 48).

## Connecting your Mobile Device

1. Connect your iPad with your VIVO H7/H3 by using a USB iPad camera connector and a USB cable.

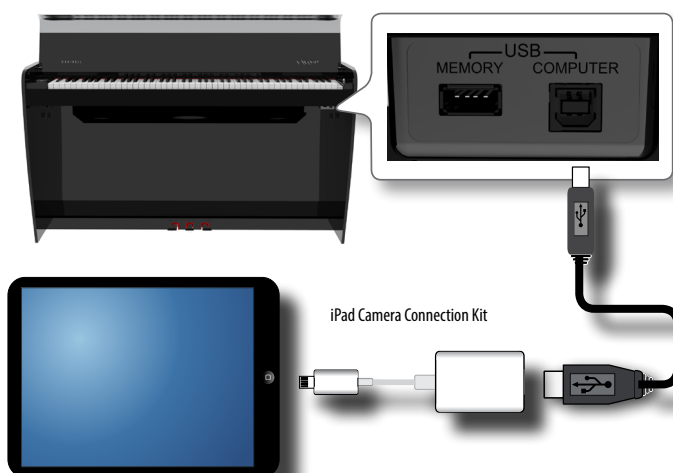

# 18 Wireless Function

## Bluetooth® Audio Connectivity

VIVO H7/H3 Pianos are equipped with Bluetooth® Audio function. Thanks to this technology, you'll be able to stream music wirelessly from a Bluetooth® capable smartphone, tablet or computer to VIVO H7/H3.

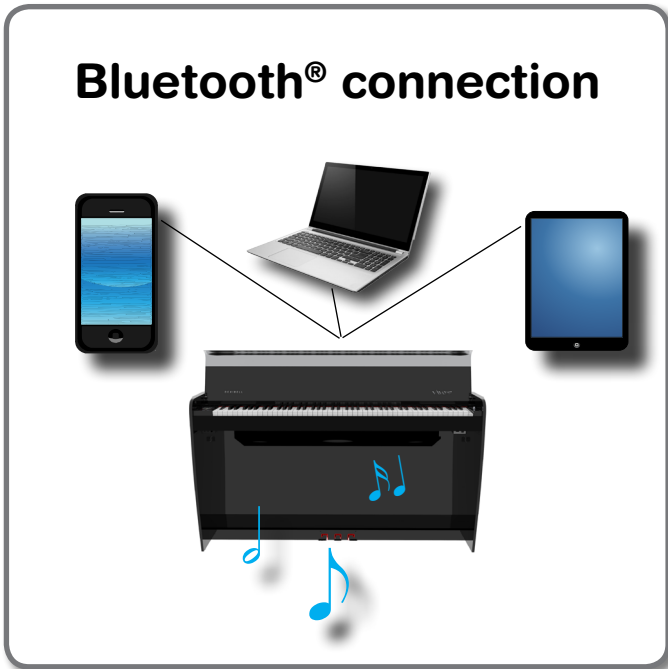

## Preliminary Operation, Pairing a Mobile Device

The first time you use a new mobile device, you need to "pair" it with your device so that both devices know how to connect securely to each other.



### NOTE

Please take in consideration that the explanation to pair your mobile device with the VIVO H7/H3 is as an example. The operations to pair your mobile device can be different from our explanation and depend on the operating system of your device. For details, please refer to the owner's manual of your mobile device.

1. Place the mobile device within 1 meter (3 ft) from VIVO H7/H3.

### NOTE

When pairing, make sure that other devices are off or out of range.

2. Make sure that VIVO H7/H3 is visible to other devices. To do it, press the [MENU] button and select Bluetooth® page.



3. Use the [▲][▼] buttons to select the "Visible" parameter.
4. Use the [◀][▶] buttons to set it "On". Your piano is now visible to other devices.

5. On the mobile device that you want to connect, turn on the Bluetooth® function and, if necessary, search for the available devices.

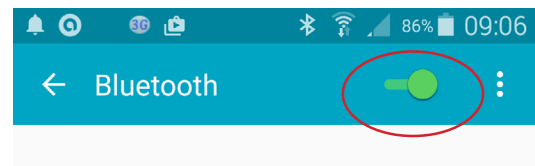

For details on how to enable the Bluetooth® function, refer to the owner's manual of your mobile device. The list of available devices is now shown in your mobile device.

6. Select the "dexi-piano-xx" device that is shown in the Bluetooth® list of your mobile device.

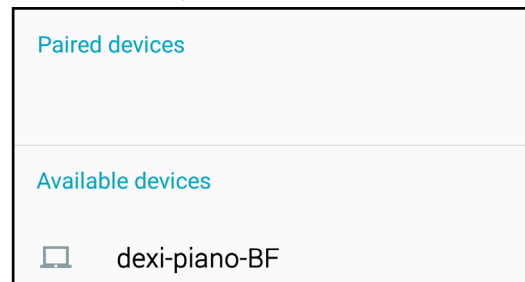

In example above the device name is "dexi-piano-BF".

7. If the mobile device and the VIVO H7/H3 ask you to confirm the connection showing the "passkey" screen, confirm before on VIVO H7/H3 and then on your mobile device.

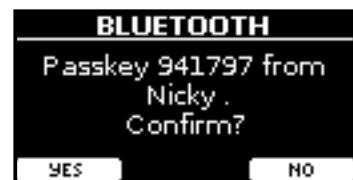

When pairing succeeds "dexi-piano-xx" is added to the list of paired devices in the mobile device. Viceversa the mobile device is added to the list of "Paired" devices of VIVO H7/H3.

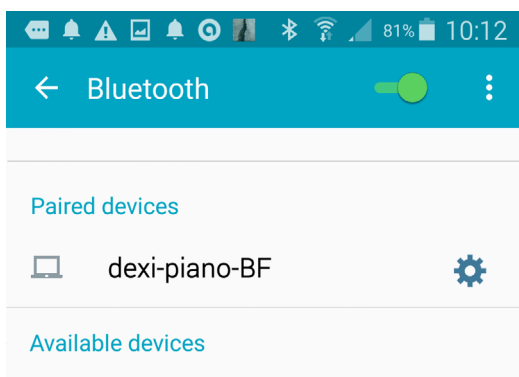

2. Use the [▲][▼] buttons to select the device.
3. Press the "CANCEL" to remove it.

The device is removed from the Bluetooth® paired list.

### 8. Select the "dexi-piano-xx" device that is shown in the paired devices list of your mobile device.

The connection is now established and a Bluetooth® icon is shown in the main menu. The music data played back by the mobile device can be heard through VIVO H7/H3.

#### MEMO

For details, refer to the owner's manual of your mobile device.

#### MEMO

Once the devices have been paired, there is no need to perform pairing again. See "Connecting an Already Paired Mobile Device" (p. 44) to connect VIVO H7/H3 with a mobile device already paired.

#### NOTE

Pairing is required again if you execute a Factory Reset (p. 34).

## Connecting an Already Paired Mobile Device

#### NOTE

Please take in consideration that the explanation to connect your mobile device with the VIVO H7/H3 is as an example. The operations to connect your mobile device can be different from our explanation and depend on the operating system of your device. For details, please refer to the owner's manual of your mobile device.

1. Place the mobile device within 1 meter (3 ft) from VIVO H7/H3.
2. If necessary, turn on the Bluetooth® function on the mobile device.
3. Select the "dexi-piano-xx" device that is shown in the Bluetooth® list of your mobile device.

The connection is now established and a Bluetooth® icon is shown in the main menu. The music data played back by the mobile device can be heard through VIVO H7/H3.

#### MEMO

For details, refer to the owner's manual of your mobile device.

## Removing a Paired Mobile Device

Sometimes is useful remove any devices you no longer use. This helps to start from scratch.

1. Press the [MENU] button and select BLUETOOTH page.

# 19 MENU Options (Advanced Section)

The VIVO H7/H3's [MENU] button provides access to the available parameters and functions.

## General procedure

### 1. Press the [MENU] button.

The display changes to:



### 2. Use the [▲] [▼] buttons to select the entry of the desired function group.

### 3. Press the [▶] button to go to the display page where you can edit the parameters of the selected group, or to execute the selected command.

For more details about the parameters selection, see "Moving the cursor and setting parameter values" (p. 21).

The following parameters and functions are available:

## Parameters Group



<b>SETTING Parameters Group</b> .....	<b>46</b>
<b>MAIN SETTING</b> .....	<b>46</b>
Level .....	46
Panpot .....	46
Octave .....	46
Mute .....	46
<b>LOWER SETTING</b> .....	<b>46</b>
<b>COUPLED SETTING</b> .....	<b>46</b>
Level .....	46
Panpot .....	46
Octave .....	46
Coarse Tune .....	46
Fine Tune .....	46
Mute .....	46
<b>KEYBOARD TOUCH</b> .....	<b>46</b>
<b>TRANSPOSE</b> .....	<b>46</b>
<b>SPLIT MODE</b> .....	<b>46</b>
Split Point .....	46
<b>4 HANDS MODE</b> .....	<b>46</b>
<b>T2L EDITOR</b> .....	<b>47</b>
<b>EFFECTS</b> .....	<b>47</b>
<b>MAIN FX</b> .....	<b>47</b>
<b>LOWER FX</b> .....	<b>47</b>
<b>COUPLED FX</b> .....	<b>47</b>
<b>REVERB</b> .....	<b>47</b>
<b>MASTER EQ</b> .....	<b>47</b>
<b>CONTROL</b> .....	<b>47</b>
<b>DAMPER PEDAL</b> .....	<b>47</b>
Part .....	47
<b>CENTRAL PEDAL</b> .....	<b>47</b>
Funct .....	48
Part .....	48
<b>LEFT PEDAL</b> .....	<b>48</b>
Funct .....	48

Part .....	48
<b>TEMPO</b> .....	<b>48</b>
<b>TEMPO/TAP</b> .....	<b>48</b>
<b>METRONOME</b> .....	<b>48</b>
<b>TUNING</b> .....	<b>48</b>
<b>MASTER TUNE</b> .....	<b>48</b>
<b>TEMPERAMENT</b> .....	<b>49</b>
Equal Flat, .....	49
Equal Stretch (default), .....	49
Vallotti, .....	49
Just Major, .....	49
Pythagorean, .....	49
Mean-Tone, .....	49
Werckmeister III, .....	49
Kimberger III, .....	49
User 1, User 2, User 3 .....	49
<b>MEMORY</b> .....	<b>50</b>
<b>USB REMOVE</b> .....	<b>50</b>
<b>AUDIO INPUT</b> .....	<b>50</b>
<b>LEVEL</b> .....	<b>50</b>
<b>BLUETOOTH</b> .....	<b>50</b>
<b>MIDI</b> .....	<b>50</b>
<b>RECEPTION</b> .....	<b>50</b>
Main, Coupled, Lower .....	51
Status .....	51
Channel .....	51
Shift .....	51
Modulation .....	51
Volume .....	51
Panpot .....	51
Expression .....	51
Reverb .....	51
Chorus .....	51
Hold .....	51
Sostenuto .....	51
Soft .....	51
PG (Program Change) .....	51
PB (Pitch Bender) .....	51
<b>TRANSMISSION</b> .....	<b>51</b>
Main, Coupled, Lower .....	51
Status .....	51
Channel .....	51
Shift .....	51
Local .....	51
Modulation .....	51
Volume .....	51
Panpot .....	51
Expression .....	51
Reverb .....	51
Chorus .....	51
Hold .....	51
Sostenuto .....	51
Soft .....	51
PG (Program Change) .....	51
PB (Pitch Bender) .....	51
<b>MIDI SET</b> .....	<b>51</b>
<b>SAVE MIDI SET</b> .....	<b>51</b>
<b>GLOBAL</b> .....	<b>51</b>
<b>Speaker</b> .....	<b>52</b>
<b>Auto OFF</b> .....	<b>52</b>
<b>Pedal</b> .....	<b>52</b>

FACTORY RESET	.....52
VERSION INFO	.....52

**NOTE**

The parameters can be stored in various memory areas. The following table shows you how to know in which area it is stored.

Icons	Explanation
 <p>INTERNAL MEMORY</p>	<p>This symbol indicates that the parameter or the parameters group can be stored in the Internal Memory area. See "Working with the Memories" (p. 38).</p>
 <p>GLOBAL MEMORY</p>	<p>This symbol indicates that the parameter or the parameters group can be stored in the Global Internal Memory area. The Global Internal Memory Area is automatically saved when you turn off the instrument.</p> <p><b>NOTE</b></p> <p>Use the appropriate button to turn off the instrument. Do not disconnect the power adapter from the outlet before the instrument is turned off.</p>

## SETTING Parameters Group

[MENU] button →SETTING

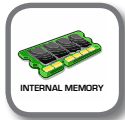

In this parameters group you can access to the important settings of your digital piano.



▶ **MAIN SETTING**

This is where you can edit parameters related to keyboard Main part

Parameter	Setting	Explanation
Level	0 ~ 127	Adjusts the volume of the Main keyboard part. Selecting "0" means that the part in question is no longer audible.
Panpot	-64 ~ 0 ~ +63	Use this parameter to set the stereo placement of the selected instrument. "0" means "no change", negative values shift the instrument towards the left, and positive values shift it towards the right.

Parameter	Setting	Explanation
Octave	-4 ~ 0 ~ +4	Use this parameter to transpose the selected instrument up or down by up to 4 octaves.
Mute	OFF, ON	Select "ON" to mute the keyboard part.

▶ **LOWER SETTING**

Contains the parameters for the keyboard Lower part  
Same settings as Main part. See above.

▶ **COUPLED SETTING**

Contains the parameters for the Coupled part.

Parameter	Setting	Explanation
Level	0 ~ 127	Same settings as Main part. See above.
Panpot	-64 ~ 0 ~ +63	
Octave	-4 ~ 0 ~ +4	
Coarse Tune	-24 ~ 0 ~ +24	The Coarse and Fine Tune are used to create interference pattern between two sounds of slightly different frequencies. Changes the pitch in semi-tone steps.
Fine Tune	-99 ~ 0 ~ +99	Changes the pitch in steps of 1 cent (1/100 semi-tone).
Mute	OFF, ON	Select "ON" to mute the keyboard part.

▶ **KEYBOARD TOUCH**

See "Adjusting the Keyboard Response (Key Touch)" (p. 33).

▶ **TRANPOSE**

This function allows you to transpose the VIVO H7/H3's pitch in semi-tone steps. Depending on the mode setting, this transposition applies to all sections or just a specific setting. For more details see "Transposing the pitch of the keyboard" (p. 31).

▶ **SPLIT MODE**

This parameter allows you to set the point of keyboard split.

**MEMO**

You can also select this parameter pressing and holding the [  ] button until the display shown the following page:



Parameter	Setting	Explanation
Split Point	F1 ~ C#7 Default: F3	See "How to change the Split Point" (p. 23).

▶ **4 HANDS MODE**

This function divides the keyboard into two sections, left and right zone, so that two people can play the same range of pitches, just as though there were two pianos.

**MEMO**

You can also select this page pressing and holding simultaneously press the [ ] and [ ] button.



For more information regarding these parameters, see "Four Hands Mode" (p. 27).

## T2L EDITOR

[MENU] button → T2L EDITOR

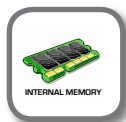

See "Personalizing Your Sounds" (p. 29).

## EFFECTS

[MENU] button → EFFECTS

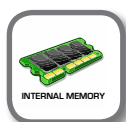

Your instrument contains two multi-effects (FX-A and FX-B) processor that can be used for processing any Keyboard part you like.

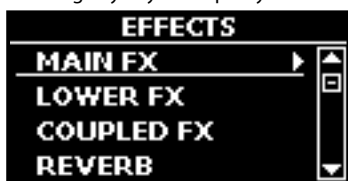

### ▶ MAIN FX

This selection provides access to the display pages where you can set the effects parameters of the VIVO H7/H3's Main part.

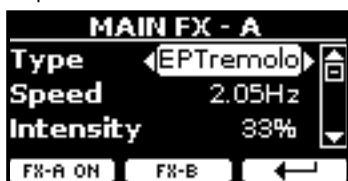

For details regarding effects parameters, refer to the "Effects Types and Parameters" table p. 53.

For more details about the selection of FXs and the relative parameters, see the section "Sound Effects" (p. 28).

### ▶ LOWER FX

Contains the effect parameters for the keyboard Lower part  
Same settings as Main part. See above.

### ▶ COUPLED FX

Contains the effect parameters for the Coupled part  
Same settings as Main part. See above.

### ▶ REVERB

See "Adding Reverb to the Sound" (p. 28).

### ▶ MASTER EQ

See "Master Equalizer" (p. 33).

## CONTROL

[MENU] button → CONTROL



This group of parameter is related to the pedal controls. The VIVO H7/H3 allows you to manage and assign various function to the pedals.

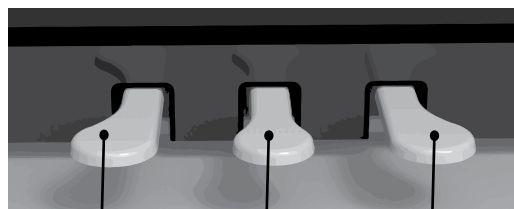

Left Pedal      Central Pedal      Damper Pedal



### ▶ DAMPER PEDAL



Parameter	Setting	Explanation
Part	Off, Main, Coupled, Lower, Main+Lw, Main+Cp	<b>OFF:</b> Select "OFF" if you don't need damper pedal. <b>MAIN, COUPLED, LOWER, MAIN+LW, MAIN+CP:</b> the damper pedal is assigned to the specified part or parts.

### ▶ CENTRAL PEDAL



## MENU Options (Advanced Section)

Parameter	Setting	Explanation
Funct.	OFF, Sostenuto, Soft, FXA On-Off, FXB On-Off, Memory Up, Memory Dw, Rotary S/L, Part On/Off, XMure FillUp, XMure FillDw, XMure SceneUp, XMure SceneDw, XMure Play/Stop  Default: Sostenuto	<b>Off:</b> No function assigned See "Pedal Functions Explanation" (p. 48).
Part	Off, Main, Coupled, Lower, Main+Lw, Main+Cp	<b>OFF:</b> Select "OFF" if you don't need of pedal. <b>MAIN, COUPLED, LOWER, MAIN+LW, MAIN+CP:</b> the pedal is assigned to the specified part or parts.

### ▶ LEFT PEDAL



Parameter	Setting	Explanation
Funct.	Off, Sostenuto, Soft, Damper, FXA On-Off, FX2BOn-Off, Memory Up, Memory Dw, Rotary S/L, Part On/Off, XMure FillUp, XMure FillDw, XMure SceneUp, XMure SceneDw, XMure Play/Stop  Default: Soft	<b>Off:</b> No function assigned See "Pedal Functions Explanation" (p. 48).
Part	Same as "Int. Part" of CENTRAL pedal. See the above explanation.	

## Pedal Functions Explanation

Function	Explanation
<b>Sostenuto</b>	The pedal is used as Sostenuto.
<b>Soft</b>	The pedal is used as Soft The soft pedal reduces the volume and slightly changes the timbre of notes played while the pedal is pressed.
<b>Damper</b>	This assignment is useful when you use the "4 Hands" mode, see "Four Hands Mode" (p. 27).
<b>FXA On-Off</b> <b>FXB On-Off</b>	Allows you to switch the MFXA/B on and off.

Function	Explanation
<b>Memory Up</b> <b>Memory Dw</b>	Allows you to select the next or previous Memory.
<b>Rotary S/L</b>	This function alternate between the fast and slow Rotary speeds.
<b>Part On/Off</b>	Enable or disable the selected keyboard part.
<b>XMure FillUp</b> <b>XMure FillDw</b>	Using these functions you can select a the next or the previous drum pattern in the XMure® application.
<b>XMure SceneUp</b> <b>XMure SceneDw</b>	These functions allow you to change scene of the accompaniment in the XMure® application.
<b>XMure Play/Stop</b>	Play or Stop the playback of a XMure® pattern.

## TEMPO

[MENU] button →TEMPO

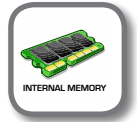

### ▶ TEMPO/TAP



Please refer to "How to Adjust the Tempo Value" (p. 32) and "Use Tap Tempo Function to set the Tempo Value" (p. 32).

### ▶ METRONOME



Please refer to "Practicing with the Metronome" (p. 31).

## TUNING

[MENU] button →TUNING



### ▶ MASTER TUNE





Setting	Explanation
415.4 Hz~ 440.00 Hz~ 466.1 Hz	Select the desiderate tuning
"440.00 Hz" Function button	Use the "440.00 Hz" and "442.00 Hz" Function buttons to tuning the instrument at those values.
"442.00 Hz" Function button	

**Some Information About the Master Tune**

Pianos are generally tuned to an A 440 pitch standard that was adopted during the early 1900s in response to widely varying standards. Previously the pitch standards had gradually risen from about A 415 during the late 1700s and early 1800s to A 435 during the late 1800s. Though A 440 is generally the standard, some orchestras, particularly in Europe, use a higher pitch standard, such as A 444.

► **TEMPERAMENT**



The modern pianos are tuning in Equal Stretch temperament, in which every pair of adjacent pitches is separated by the same interval.

There are other scale used in different music style. Modern musical scale in western culture are different in one other way from older classic music. At the time of Bach the scales were based on the note A being about 415 Hz. In the Handel's time the frequency A was 422.5 Hz and today it is 440.0 Hz.

Setting	Explanation
Equal Flat, Equal Stretch (default), Vallotti, Just Major, Pythagorean, Mean-Tone, Werckmeister III, Kimberger III, User 1, User 2, User 3	<p><b>Equal Flat:</b> his tuning divides each octave into 12 equal steps (intervals).</p> <p><b>Equal Stretch:</b> This tuning is a correction of Equal Flat. A benefit of stretching octaves is the correction of dissonance that equal temperament imparts to the perfect fifth.</p> <p><b>Vallotti:</b> This tuning is the default for many of today's Baroque musicians.</p> <p><b>Just Major:</b> This is a just scale for pieces in mayor keys.</p> <p><b>Pythagorean:</b> This system was invented in ancient Greece. It resolves the ambiguity of fourths and fifths. Though thirds are somewhat imperfect, melodies sound clearer.</p> <p><b>Mean-Tone:</b> A temperament that adds some compromises to the just temperament and facilitates transposition.</p> <p><b>Werckmeister III:</b> A combination of the Mean Tone and Pythagorean temperaments, this tuning allows for playing in any key.</p> <p><b>Kimberger III:</b> As a result of improvements made to the Mean Tone and Just temperaments, this tuning system is relatively tolerant towards transposition and can be used to play in all keys.</p> <p><b>User 1, User 2, User 3:</b> These settings refer to the tuning systems programmed by yourself (or someone else).</p>

1. Select your favorite temperament scale .
2. Press the "RECALL" Function button to load the scale.  
The temperament scale is recalled.

**Editing the Equal Flat, Equal Stretch or Vivo Stretch scale**

If you selected the Equal Flat, Equal Stretch or Vivo Stretch scale:  
The "EDIT" Function button appears.

1. Press the "EDIT" Function button to program your scale.

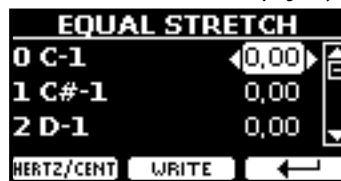

In the example above we select the Equal Stretch scale.

2. To select a note, use the [▲][▼] or play a note on the keyboard.
3. Use the [◀][▶] buttons to modify the tuning of the selected note.
4. Press [FINE] Function button to change the tuning in steps of 1/100 of cent.

Setting	Explanation
-99.99 ~ 0 ~ +99.99 (cent)	Set the note tuning.

5. Press the "WRITE" Function button to save your scale.

The following page appears:



6. Use the [▲][▼] buttons to select the USER scale where you want save your scale.
7. Press the "WRITE" Function button to save your scale.  
A message of confirmation appears.

**If you selected a scale other than equal temperament:**

1. If you selected a scale other than equal temperament as Pythagorea, Mean-Tone, Werckmeister III, Kimberger III and the Just Major and Minor temperament scale, you can specify the root note:

The "ROOT NOTE" Function button appears.



2. Press the "ROOT NOTE" Function button if you want specify the base note.



3. Select the root note.

Setting	Explanation
C, C#, D, Eb, E, F, F#, G, Ab, A, Bb, B	Select the base note of the temperament scale.

4. Press the "←" Function button come back to previous page.

If you selected one of USER scales:  
The "EDIT" Function button appears.



1. Press the "EDIT" Function button to program your scale.



- To select a note, use the [▲][▼] or play a note on the keyboard.
- Use the [◀][▶] buttons to modify the tuning of the selected note.
- Press [FINE] Function button to change the tuning in steps of 1/100 of cent.

Setting	Explanation
-99.99 ~ 0 ~ +99.99 (cent)	Set the note tuning.

- Press the "WRITE" Function button to save your scale.  
A message of confirmation appears.
- Press the "←" Function button come back to previous page.

## MEMORY

[MENU] button →MEMORY

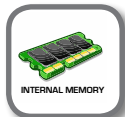

For the explanation of this section please refer to "Working with the Memories" (p. 38).

## USB REMOVE

[MENU] button →USB REMOVE

Before to unplug the USB Memory, use this function to safely remove it. See "Safely Remove the USB Memory" (p. 18).

## AUDIO INPUT

[MENU] button →AUDIO INPUT

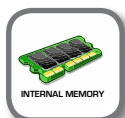

## LEVEL

Setting	Explanation
1 ~ 127	Here you can adjust the input level of the signals received via Audio In socket.

## BLUETOOTH

[MENU] button →BLUETOOTH

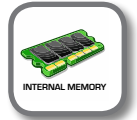

VIVO H7/H3 Pianos are equipped with Bluetooth® Audio function. Thanks to this technology, you'll be able to stream music wirelessly from a Bluetooth® capable smartphone, tablet or computer to VIVO H7/H3. For details see "Wireless Function" (p. 43).

## MIDI

[MENU] button →MIDI

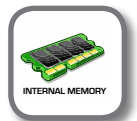

This group allow you to configure the MIDI parameters. You can transfer MIDI data between the VIVO H7/H3 and your sequencer software.



Here is a brief explanation of VIVO H7/H3 keyboard parts:

Part	Explanation
Main	At power-on, the instrument is automatically selected in Grand Piano Mode. All keyboard play note in the Main part.  Main Part
Coupled	This part can be combined with the Main part. To do this press the [  ] button. The second part (Coupled Part) play over the entire keyboard in combination with the Main part.  Main Part + Coupled Part
Lower	This part is activated when you split the keyboard in two zone: Left and Right. To split the keyboard press the [  ] button. The Keyboard is now divided into two sections. The region of the keyboard to the left of the split point becomes the Lower part, while the region of the keyboard to the right of the split point becomes the Main part.  Lower Part Main Part

- Select the group of parameters you need (Reception, Transmission and Global).

## RECEPTION



You can configure the MIDI receive parameters of Main, Coupled and Lower part.

1. Select the part you want to edit (Main Coupled and Lower).



In the example above we selected the Main keyboard part.

Main, Coupled, Lower		
Parameter	Setting	Explanation
Status	Off, On Default: On	Select "On" if you want the selected part to receive MIDI data.
Channel	1 ~ 16 Default: 1	Allows you to assign a MIDI receive channel to the selected part.
Shift	-48~0~+48 Default : 0	This parameter allows you to transpose the received note messages before sending them to the VIVO H7/H3's tone generator. The maximum possible transposition is four octaves up (48) and down (-48). Each step represents a semi-tone.
Modulation	Off, On Default: On	These filters allow you to specify whether (On) or note (Off) the messages in question should be received.
Volume		
Panpot		
Expression		
Reverb		
Chorus		
Hold		
Sostenuto		
Soft		
PG (Program Change)		
PB (Pitch Bender)		

Part	MIDI RX channel (default)
Main	1
Coupled	3
Lower	2

Main, Coupled, Lower		
Parameter	Setting	Explanation
Status	Off, On Default: On	Select "On" if you want the selected part to transmit MIDI data.
Channel	1 ~ 16 Default: 1	Allows you to assign a MIDI transmit channel to the selected part.
Shift	-48~0~+48 Default : 0	This parameter allows you to transpose the note messages before they are transmitted to an external MIDI device. The maximum possible transposition is four octaves up (48) or down (-48).
Local	Off, On Default: On	You can disconnect the part from the internal sound source ("Off") – or re-establish that connection ("On").
Modulation	Off, On Default: On	These filters allow you to specify whether (On) or note (Off) the messages in question should be transmitted.
Volume		
Panpot		
Expression		
Reverb		
Chorus		
Hold		
Sostenuto		
Soft		
PG (Program Change)		
PB (Pitch Bender)		

► MIDI SET

MIDI Sets are memories for MIDI settings. The VIVO H7/H3 provides four MIDI Set memories. The first memory, called "Dexibell", is read-only and allows you to restore the MIDI factory setting. The other three memories allow use to memorize and recall your MIDI configuration.



1. Use the [▲][▼] to select the MIDI Set and press the "RECALL" Function button to load it.
2. Press the "SAVE" Function button to jump in the SAVE MIDI SET page.

► SAVE MIDI SET



1. Use the [▲][▼] to select the MIDI Set memory and press the "WRITE" Function button to save your configuration.

► TRANSMISSION



You can configure the MIDI transmission parameters of Main, Coupled and Lower part.

1. Select the part you want to edit (Main Coupled and Lower).



In the example above we selected the Main part.

GLOBAL

[MENU] button → GLOBAL



These parameters allow you to adjust some global aspect of your piano. These parameters are automatically saved in the VIVO H7/H3 global

memory area.



Parameter	Setting	Explanation
Speaker	OFF, ON, AUTO	<p><b>OFF:</b> When you use VIVO H7/H3 for live performances and therefore connect it to an external amplification system, it may be convenient to switch off VIVO H7/H3 internal speakers</p> <p><b>ON:</b> Choose this option if you want to use VIVO H7/H3 internal speakers. Connecting a pair of headphones, the internal speakers continue to produce sound.</p> <p><b>AUTO:</b> Choose this option if you want to use the VIVO H7/H3 internal speakers. Connecting a pair of headphones mutes the internal speakers.</p>
Auto OFF	Off, 5 min, 10 min, 30 min, 2 hours, 4 hours Default: 2 hours	<p>This parameter allows you to cause the VIVO H7/H3 to switch itself off after the selected number of minutes has elapsed if you are not using it.</p> <p>Select "Off" if you prefer not to use this function.</p>
Pedal	Global, Memory	<p><b>Global:</b> Set this value if you want the pedal assignments are saved in the global area. The pedal assignment does not depend on the recalled memory.</p> <p><b>Memory:</b> Set this value if you want the pedal assignments are saved in the Memories. The pedal assignment depends on the recalled memory.</p>

## FACTORY RESET

[MENU] button →FACTORY RESET

This function allows you to recall the VIVO H7/H3's original factory settings. Please see "Restoring the Factory Settings (Factory Reset)" (p. 34).

## VERSION INFO

[MENU] button →VERSION INFO

This page shows you the version number of theVIVO H7/H3's operating system.

## Effects Types and Parameters List

### 1: Thru

The effects processor is bypassed.

### 2: EP Tremolo

This effect cyclically modulates (Speed) the amplitude (Intensity) to add tremolo to the sound. It's the electric piano typical effect.

Parameter	Setting	Explanation
Speed	0.10 ~ 12.50 Hz	Sets the speed of the tremolo effect.
Intensity	0 ~ 100	Depth to which the effect is applied.

### 3: Equalizer

This is a four-band stereo equalizer (low, mid x 2, high).

Parameter	Setting	Explanation
Low Freq	80 ~ 400	Selects the frequency of the low range.
Low Gain	-12 ~ 0 ~ +12	Adjusts the gain of the low frequency.
High Freq	800Hz ~ 8KHz	Selects the frequency of the high range.
High Gain	-12 ~ 0 ~ +12	Adjusts the gain of the high frequency.
Mid1 Freq	200Hz ~ 4KHz	Selects the frequency of the Mid1 range.
Mid1 Gain	-12 ~ 0 ~ +12	Adjusts the gain of the Mid1 frequency.
Mid1 Q	0.5 ~ 12.0	Move this parameter to adjust the width of the area around the Middle 1 frequency that will be affected by the Gain setting. Higher values of Mid1 Q set narrowest area.
Mid2 Freq	200Hz ~ 4KHz	Selects the frequency of the Mid2 range.
Mid2 Gain	-12 ~ 0 ~ +12	Adjusts the gain of the Mid2 frequency.
Mid2 Q	0.5 ~ 12.0	Move this parameter to adjust the width of the area around the Middle 2 frequency that will be affected by the Gain setting. Higher values of Mid2 Q set narrowest area.

### 4: Vibrato

Vibrato is a musical effect consisting of a regular, pulsating change of pitch. It is used to add expression to instrumental music.

Parameter	Setting	Explanation
Rate	0.10 ~ 12.50 Hz	Sets the speed of the vibrato effect.
Intensity	0 ~ 100	Allows you to set the vibrato intensity.

### 5: Flanger

This effect gives a significant swell and movement of pitch to the sound. It produces a metallic resonance effect.

Parameter	Setting	Explanation
Rate	0.10 ~ 12.50 Hz	Adjust the modulation speed.
Intensity	0 ~ 100	Allows you to set the flanger intensity.
Feedback	-96 ~ +96 %	Adjusts the proportion of the flanger sound that is fed back into the effect. Negative (-) settings will invert the phase.
Balance	0 ~ 100	Balance the Volume between the direct and the effect sound.

Parameter	Setting	Explanation
PreDelay	0 ~ 100 ms	Adjusts the delay from the direct signal and the moment when the flanger starts working.
Phase	0 ~ 180 deg	This sets the LFO phase difference between the left and right, in steps of 10 degrees It give more spatial of the sound.

### 6: Chorus

This effect adds thickness and warmth to the sound by modulating the delay time of the input signal. You can add spread to the sound by offsetting the phase of the left and right LFOs from each other.

Parameter	Setting	Explanation
Rate	0.10 ~ 12.50 Hz	Adjust the modulation speed.
Intensity	0 ~ 100	Allows you to set the chorus intensity.
Feedback	-96 ~ +96 %	Adjusts the proportion of the chorus sound that is fed back into the effect. Negative (-) settings will invert the phase.
Balance	0 ~ 100	Balance the Volume between the direct and the effect sound.
PreDelay	0 ~ 100 ms	Adjusts the delay from the direct signal and the moment when the chorus starts working.
Phase	0 ~ 180 deg	This sets the LFO phase difference between the left and right, in steps of 10 degrees.

### 7: Phaser

This effect creates a swell by shifting the phase. It is very effective on electric piano sounds. You can add spread to the sound by offsetting the phase of the left and right LFOs from each other.

Parameter	Setting	Explanation
Rate	0.10 ~ 12.50 Hz	Adjust the modulation speed.
Intensity	0 ~ 100	Allows you to set the phaser intensity.
Feedback	-96 ~ +96 %	Adjusts the proportion of the phaser sound that is fed back into the effect. Negative (-) settings will invert the phase.
Phase	0 ~ 180 deg	This sets the LFO phase difference between the left and right, in steps of 10 degrees.

### 8: Reverb

This effect adds reverberation to the sound, simulating an acoustic space as a room or a larger halls or stadiums.

Parameter	Setting	Explanation
Level	0 ~ 127	Set the quantity of Reverb effect
Damping	0 ~ 127	Adjusts the amount of damping of the room (Carpet, Wood, Brick, Concrete, Marble). Higher values increase the amount of high-frequency attenuation.
Room Size	0 ~ 127	It determines the size of the simulated room.
Width	0 ~ 127	Adjusts the stereo width of the Reverb effect. Higher value increase the stereo width.
PreDelay	0 ~ 100 ms	Adjusts the delay from the direct signal and the moment when the reverb starts working. This is used to simulate the distance between the original signal and the reflective surfaces.

## 9: Delay

The delay effect is used to simulate echo (repetition).

Parameter	Setting	Explanation
Delay L	0 ~ 500 ms	Sets the delay time for the left channel.
Delay R	0 ~ 500 ms	Sets the delay time for the right channel.
Feedback	-96 ~ +96 %	Adjusts the proportion of the delay sound that is fed back into the effect. Negative (-) settings will invert the phase.
Wet	0 ~ 100 %	Adjust the quantity of the delayed ("wet") signal.
Dry	0 ~ 100 %	Adjust the quantity of the unmodified ("dry") signal.

## 10: Cross Delay

Cross Delay allows you to create advanced stereo delay.

Each echo can be sent to the opposite channel from the source signal (echo of the left channel is heard on the right).

Parameter	Setting	Explanation
Delay L	0 ~ 500 ms	Sets the delay time for the left channel.
Delay R	0 ~ 500 ms	Sets the delay time for the right channel.
Feedback	-96 ~ +96 %	Adjusts the proportion of the delay sound that is fed back into the effect. Negative (-) settings will invert the phase.
Wet	0 ~ 100 %	Adjust the quantity of the delayed ("wet") signal.
Dry	0 ~ 100 %	Adjust the quantity of the unmodified ("dry") signal.

## 11: Triple Tap Delay

The Triple Tap Delay produces three delay sounds: center, left and right..

Parameter	Setting	Explanation
Delay L	0 ~ 500 ms	Sets the delay time for the left channel.
Delay R	0 ~ 500 ms	Sets the delay time for the right channel.
Delay C	0 ~ 500 ms	Sets the delay time for the center (L+R) channel.
Feedback	-96 ~ +96 %	Adjusts the proportion of the delay sound that is fed back into the effect. Negative (-) settings will invert the phase.
Level L	0 ~ 100	Adjust the volume of the left delay sound.
Level R	0 ~ 100	Adjust the volume of the right delay sound.
Level C	0 ~ 100	Adjust the volume of the center delay sound.
Wet	0 ~ 100 %	Adjust the quantity of the delayed ("wet") signal.
Dry	0 ~ 100 %	Adjust the quantity of the unmodified ("dry") signal.

## 12: Rotary

The rotary is a typical effect generated by the rotation of the speakers, this rotation creates a Larsen effect. It gives spaciousness to the sound..

Parameter	Setting	Explanation
Speed	Slow, Fast	Switches the speaker rotation speed between slow and fast.
Brake	Off, On	This parameter allows you to manually control the wheel brake. Off is the default; the tone wheels will turn normally. Changing this to On will make the tone wheels gradually slow down and stop.
Vibrato Sw	Off, On	Disable and enable the vibrato effect.
Vibrato Type	V1, C1, V2, C2, V3, C3	This selects one of the six classic Vibrato/Chorus presets. "V" stands for Vibrato, and "C" stands for Chorus.

## 13: Tremolo

This effect cyclically modulates (Speed) the amplitude (Intensity) to add tremolo to the sound.

Parameter	Setting	Explanation
Speed	0.10 ~ 12.50 Hz	Sets the speed of the tremolo effect.
Intensity	0 ~ 100	Depth to which the effect is applied.

## 14: Tremolo Pan

This effect is similar to the Tremolo. It include an extra parameter that indicate the phase between the left or right channel.

Parameter	Setting	Explanation
Speed	0.10 ~ 12.50 Hz	Sets the speed of the tremolo effect.
Intensity	0 ~ 100	Depth to which the effect is applied.
Phase	0 ~ 180 deg	This sets the LFO phase difference between the left and right, in steps of 10 degrees.

## 15: Overdrive

This effect is designed to work and sound like an old tube amp turned up loud. It suitable for hard rock and similar musical genres.

Parameter	Setting	Explanation
Drive	1 ~ 100	Higher Drive settings, mean more distortion.
Tone	100 Hz ~ 10.0 KHz	Use this parameter to accent or attenuate certain dominant or unwanted overtones.
Level	0 ~ 100	Increase or decrease the volume of the effect.
Low Freq	80 ~ 400	Selects the frequency of the low range.
Low Gain	-12 ~ 0 ~ +12	Adjusts the gain of the low frequency.
High Freq	800Hz ~ 8KHz	Selects the frequency of the high range.
High Gain	-12 ~ 0 ~ +12	Adjusts the gain of the high frequency.

## H7/H3 Tone List

Num.	Name	PC	CC00	Num.	Name	PC	CC00
MODERN				0043	80's Strings	52	0
0001	VIVO Grand	2	0	0044	Classic Choir	53	1
0002	Pop Grand	2	1	0045	Space Vox	55	1
0003	Elec.Grand	3	2	0046	Mmh Choir	53	0
0004	E.Grand Trem	3	3	0047	Choir Pad	54	1
0005	Rock Piano	3	1	0048	Synth Vox	55	0
0006	Honky Tonk	4	1	0049	Warm Pad	90	0
CLASSIC				0050	Dark Pad	54	0
0007	Classic Grand	1	0	0051	Soft Pad	90	1
0008	Romantic	1	1	0052	Square Pad	90	2
0009	VIVO Upright	1	2	0053	Brass Ens.	62	1
0010	Ragtime	4	0	0054	Brass Sect.	62	0
0011	Harpsi 8'	7	0	0055	Synth Brass	63	0
0012	Harpsi 4'	7	1	0056	Poly Brass	63	1
0013	Coupled Hps.	7	2	0057	Poly Synth	91	0
0014	Pop Harpsi	7	3	0058	Super Saw	91	1
E.PIANO				0059	Fast Synth	91	2
0015	Dyno Stage	5	0	 (MORE)			
0016	Suitcase	5	1	0060	Vibraphone	12	0
0017	Phaser EP	5	2	0061	Xilophone	14	0
0018	Wurly	5	5	0062	Marimba	13	0
0019	Trem.Wurly	5	6	0063	Celesta	9	0
0020	Soft E.Piano	5	3	0064	Harp	47	0
0021	Bright E.Piano	5	4	0065	Cool Clav	8	0
0022	FM Full Tines	6	0	0066	Groovy Clav	8	1
0023	FM E.Piano	6	1	0067	Doctor Clav	8	2
ORGAN				0068	Funky Clav	8	3
0024	Principal	20	0	0069	Nylon Guitar	25	0
0025	Princip & Flute	20	1	0070	Steel Guitar	26	0
0026	Church	20	2	0071	Jazz Guitar	27	0
0027	Mixture	20	3	0072	Overdrive GT.	30	0
0028	Pop Organ	17	2	0073	Fanta Bell	101	0
0029	Jazz Organ	18	0	0074	Dexi Heaven	101	1
0030	Blues Organ	18	1	0075	Acoustic Bs.	33	0
0031	Reggae Organ	17	0	0076	Fingered Bs.	34	0
0032	R&B Organ	17	1	0077	Picked Bs.	35	0
0033	Rock Organ	19	0	0078	Ac.Bass&Ride	33	1
0034	Gospel Organ	19	1	0079	Synth Bass	39	0
ENSEMBLE							
0035	Slow Strings	50	0				
0036	Strings	50	1				
0037	Fast Strings	49	0				
0038	Strings Ens.	50	2				
0039	Orchestra	49	1				
0040	Dark Strings	50	3				
0041	Strings Pad	51	0				
0042	Syn. Strings	51	1				

# 21 Troubleshooting

Symptom	Action	Page
Power turns automatically off.	This is normal and due to the Auto Power Off function. If necessary, set the parameter of the Auto Power Off function. If you don't need the power to turn off automatically, turn the "AUTO OFF" setting "Disable".	52
The instrument does not turn on.	Is the AC adaptor/power cord correctly connected to an AC outlet and to the VIVO H7/H3?  <b>NOTE</b> Do not use any AC adaptor or power cord other than the ones included. Doing so will cause malfunctions.	16
	Could you have turned the power on again immediately after turning the power off? Allow an interval of at least five seconds before turning the power on again.	-
No sound from the VIVO H7/H3.	Did you switch the VIVO H7/H3 on?	18
	Could the [VOLUME] knob be turned down? Select a higher setting.	-
	Could the part volume settings have been minimized? Check the "LEVEL" setting of each part.	46
The volume level of the instrument is too low when it is connected to an amplifier.	Could you be using a connection cable that contains a resistor? Use a connection cable that doesn't contain a resistor.	-
Insufficient volume from a device connected to the VIVO H7/H3's INPUT jack.	Could you be using a connection cable that contains a built-in resistor? Use a connection cable that does not contain a resistor.	-
	Could the AUDIO IN Level be down? Select a higher setting.	50
The keyboard volume is lower than the Song playback volume.	The volume level for the keyboard performance is set too low. Adjust the volume balance to increase the keyboard volume via the Song Control Menu.	35
The pitch of the instrument is incorrect.	Is the "Tuning" or "Temperament" setting appropriate? Check the parameters.	48
	Did you transpose the instrument?	46
A "buzz" is heard from the external amplifier.	Is the external amplifier or other device used with the VIVO H7/H3 connected to a different AC power outlet? Connect the amplifier or other device to the same AC outlet as the VIVO H7/H3.	-
	The noise may be due to interference caused by the use of a mobile phone in close proximity to the instrument. Turn off the mobile phone, or use it further away from the instrument.	-
After connecting the VIVO H7/H3's USB COMPUTER port to your computer, the VIVO H7/H3 doesn't receive MIDI messages.	The VIVO H7/H3 may be receiving on a MIDI channel on which the MIDI controller doesn't transmit. Correct the MIDI controller's transmit channel.	50
Unable to read from/write to USB Memory.	Check the format of your USB Memory. The VIVO H7/H3 can use USB Memory that has been formatted as FAT. If your USB Memory was formatted using any other method, please re-format it as MS-DOS FAT.	-
Can't save to USB Memory.	Could the USB Memory be write protected?	-
	Is there sufficient free space on the USB Memory?	-
Audio recording won't start or stops unexpectedly.	Is there sufficient free space on the USB Memory?	-
The songs won't play.	The file type of the song is not one of the file types that the VIVO H7/H3 can play.	35
	It may be that the song data is damaged.	-
This "dexi-piano-xx" model name does not appear in the Bluetooth device list of your mobile device.	<ul style="list-style-type: none"> <li>Is the "Visible" parameter of VIVO H7/H3 set "On".</li> </ul>	43
The music data played back by the mobile device cannot be heard through VIVO H7/H3.	<ul style="list-style-type: none"> <li>Was it initiated the pairing function between this unit and the mobile device?</li> <li>Delete the registration from the list of your mobile device and establish pairing once again.</li> </ul>	43



ITEMS		VIVO   H7	VIVO   H3
KEYBOARD TYPE		<ul style="list-style-type: none"> <li>TP-40 GH: 88 - Keys Graded Hammer action</li> <li>Triple contact- ivory feel</li> </ul>	<ul style="list-style-type: none"> <li>TP-100 LR: 88 - Keys Hammer action</li> <li>Triple contact</li> </ul>
TONE GENERATOR		T2L: Sampling and Modelling Technology	
MODELLING		Reactive to player articulation	
SAMPLING		XXL wave size, holophonic recording up to 15 seconds on lower piano notes	
SOUND WAVE FORMAT		24 bit linear - 48 KHz (Internal processing and DSP at 32 bit floating)	
DIGITAL ANALOG CONVERSION (DAC)		24 bit linear - 48 KHz, Dynamic Range, S/N:106dB	
MAXIMUM POLYPHONY		Unlimited with 320 Oscillator	
SOUNDS		79 + Unlimited User (depending on the internal memory free), downloadable with file extensions .DXS and .SF2	
MEMORY		Preset: 20 User: Unlimited loadable from USB Memory	
KEYBOARD MODE		Layers, Split, 4 Hands	
TOUCH SENSITIVITY		7 Types + Fixed	
REVERB		6 Types	
EFFECTS		6 independent DSP Effects ( 2 x Main, 2 x Coupled, 2 x Lower) using "seamless changes" technology at effect recall	
MASTER EQUALIZER		3-band Digital Equalizer	
PLAYER AUDIO		.wav, .aiff, .mp3, in all format, frequency and bit rate	
RECORDER AUDIO		.wav (48 kHz, 32-bit floating) on USB Memory	
MASTER TUNING		YES: 415,4Hz to 466,1 Hz (adjustable increments of 0,1 Hz) + 2 Preset (440 Hz, 442 Hz)	
TEMPERAMENT		8 Types	
USER TEMPERAMENT		3 User	
RHYTHM PATTERNS		X MURE APP for i-Phone and i-Pad (FREE) with multitracks audio patterns	
METRONOME		13 Standard Tempo Preset	
PEDALS		Progressive Damper Action Pedal with sympatetic resonance simulation Progressive Soft Pedal / Function assignable Sostenuto Pedal / Function assignable	
Keyboard Lid		Soft Closing System	
Wireless Connections		<ul style="list-style-type: none"> <li>Bluetooth® audio streaming</li> <li>Wi-Fi™ (ready for future software version)</li> </ul>	
DISPLAY		Graphic LCD 128 x 64 dots Organic LED, high contrast type	
CONNECTORS	DC IN socket	for supplied AC adaptor	
	AUDIO IN jack	Stereo miniature phone type	
	Output (L/Mono, R) jacks	1/4-inch phone type x 2	
	Phones jacks	1 x Stereo miniature phone type 1 x Stereo 1/4-inch phone type	
	USB COMPUTER port	Type B	
	USB MEMORY port	Type A	
	Pedals Connector	DIN connector: Left Pedal (Assignable), Center Pedal (Assignable), Right Pedal	
SPEAKERS		2 woofer x 12,7 cm ( 5 inches) 2 Near-field Speakers x 3 cm (1,1 inches) 1 passive subwoofer 20,3 cm (8 inches)	2 woofer x 8.9 cm (3,5 inches) 2 tweeter x 1,3 cm (0,5 inches)
RATED POWER OUTPUT		56 W x 2 max	30 W x 2 max
VOLUME LEVEL SPL		113.6 dB max	108.1 dB max
DSP on AMPLIFIER	Digital Bass Enhancer	Yes	
	Dynamic Eq	Yes	
	3 Band Compressor	Yes	
Power Supply		24V DC 5A , supplied AC/DC adaptor	24V DC 2.5A , supplied AC/DC adaptor

ITEMS	VIVO   H7	VIVO   H3
<b>POWER CONSUMPTION</b>	Stand By: < 0,2 W Power On: 12 W Average: 16 W Maximum: 38 W "ErP" LEVEL VI for Echo efficiency on stand-by consumption	Stand By: < 0,2 W Power On: 12 W Average: 15 W Maximum: 32 W "ErP" LEVEL VI for Echo efficiency on stand-by consumption
<b>DIMENSIONS</b>	1420 (W) x 360 (D) x 793 mm (H) (with lid close) 1420 (W) x 360 (D) x 1009 mm (H) (with lid open) 55-15/16 (W) x 14-3/16 (D) x 31-1/4 (H) inches (with lid close) 55-15/16 (W) x 14-3/16 (D) x 39-3/4 (H) inches (with lid open)	
<b>WEIGHT</b>	62.3 kg (excluding AC adaptor) 13 lbs 12 oz (excluding AC adaptor)	44.0 kg (excluding AC adaptor) 9 lbs 12 oz (excluding AC adaptor)
<b>SUPPLIED ACCESSORIES</b>	Owner's Manual	
	AC adaptor (DEXIBELL DYS6150-2400500W)	AC adaptor (DEXIBELL DYS602-240250W)
<b>OPTIONS (sold separately)</b>		

- Bluetooth® is registered trademarks of Bluetooth SIG, Inc.
- Wi-Fi™ is registered trademarks of Wi-Fi Alliance.

### NOTE

In the interest of product, the specification and description are subject to change without notice.

## Symbols

### A

AC Adaptor .....	16
AUDIO INPUT .....	50
AUTO OFF .....	19

### B

Balance .....	27
Main and the Lower part	23
Bluetooth® .....	43

### C

Computer	
Connecting Your Computer	18
CONTROLS .....	47
COUPLED FX .....	47
COUPLED SETTING .....	46
Cursor .....	20
Cursor Operation	20
Moving the cursor	21

### D

DAMPER PEDAL .....	47
DC IN jack .....	16
Demo .....	19
Digital Player devices	
Connecting	17
Display .....	20

### E

Effect	
Reverb Effect	28
EFFECTS .....	47
Export	
Exporting the Internal Memory Set	40
External Amplifier	
Connecting an External Amplifier	17

### F

File name	
Assigning the Name You Specify	21
Four Hands .....	25,27

### G

GLOBAL .....	51
--------------	----

### H

Headphones .....	17
------------------	----

Listening Through Headphones	16
------------------------------	----

### I

Import	
Importing Memory Set	41

### J

### K

Keyboard Response (Key Touch)	
Adjusting the Keyboard Response	33
KEYBOARD TOUCH .....	46
Key Touch	
Adjusting the Keyboard Response	33

### L

Layer	
Playing Two Sounds Over the Entire keyboard (Layer)	23
LAYER MODE .....	46
LEFT PEDAL .....	48
Lid	
Opening and Closing the Lid	17
Lower	
Mute the Lower Part	24
LOWER FX .....	47
LOWER SETTING .....	46

### M

MAIN FX .....	47
MAIN SETTING .....	46
MASTER EQ .....	47
MASTER TUNE .....	48
Memories	
Exporting the Internal Memory Set in the USB Memory	40
Importing Memory Set from the USB Memory into Internal Memory.	41
Recalling your settings from an USB Memory	40
Recalling your settings from Internal Memory	38
Renaming a Memory	40
Saving Your Settings in the Internal Memory	38
Working with the Memories	38
MEMORY .....	50

### MENU

MENU Options (Advanced Section)	45
---------------------------------	----

### Metronome

Metronome Settings	31
Practicing with the Metronome	31

Setting the Metronome Time Signature	32
--------------------------------------	----

METRONOME .....	48
Metronome Settings .....	31
MIDDLE PEDAL .....	47
MIDI .....	50

### Mute

Mute the Lower Part	24
---------------------	----

### N

### O

### P

Pairing .....	43
Parameters	
GLOBAL	51
passkey .....	43
PEDAL	
DAMPER PEDAL	47
LEFT PEDAL	48
MIDDLE PEDAL	47
Pedal Cord	
Connecting the Pedal Cord	16
Power On/Off .....	18
Turning the Power On/Off	18

### Q

### R

Record	
Recording Your Performance	37
Renamie	
Renaming a Memory	40
Reverb	
Reverb Effect	28
REVERB .....	47

### S

Save	
Saving Your Settings in the Internal Memory	38
Saving Your Settings in the USB Memory	38
SETTING	
SETTING Parameters Group	46
Song	
Loading from Song Internal Memory	35
Loading from USB Memory	35
Playing a Song	35
Practice with Song Player	35

Sound Library .....	25
Sounds	
Personalizing Your Sounds	29
Specifications .....	57
Split	
Splitting the Keyboard Range and Playing Two Different Tones	23
SPLIT MODE .....	46
<b>T</b>	
T2L EDITOR .....	47
T2L-Modelling .....	29
TAP	
TEMPO/TAP	48
Tap Tempo	
Use Tap Tempo Function to set the Tempo Value	32
TEMPERAMENT .....	49
Tempo	
How to Adjust the Tempo Value	32
Use Tap Tempo Function to set the Tempo Value	32
TEMPO .....	48
TEMPO/TAP	48
Tones	
Grand Piano Mode	22
Most Frequently Used Tones (Favorite Tone)	22
Selecting Tones	22
Transpose	
Transposing the pitch of the keyboard or/ and song	31
TRANSCOPE .....	46
Troubleshooting .....	56
TUNE	
MASTER TUNE	48
TUNING .....	48

**U**

USB Memory	
Connecting an USB Memory	18
Exporting the Internal Memory Set in the USB Memory	40
Importing Memory Set from the USB Memory into Internal Memory.	41
Recalling your settings from an USB Memory	40
Saving Your Settings in the USB Memory	38

**V**

VOLUME knob .....	10
-------------------	----

**W**

Wireless	
Wireless Function	42,43

**X**

X MURE .....	42
--------------	----

**Y****Z**







For European Countries

This product complies with the requirements of EMC Directive 2004/108/EC.

For Canada

### NOTICE

This Class B digital apparatus meets all requirements of the Canadian Interference-Causing Equipment Regulations.

### AVIS

Cet appareil numérique de la classe B respecte toutes les exigences du Règlement sur le matériel brouilleur du Canada.

For European Countries

## EUROPEAN COMMUNITY DECLARATION OF CONFORMITY Radio and Telecommunications Terminal Equipment.

Dexibell declares that the wireless module of this unit is in compliance with the essential requirements and other relevant provisions of Directive 1999/5/EC.

IMPORTANT NOTICE FOR THE UNITED KINGDOM

**IMPORTANT:** THE WIRES IN THIS MAINS LEAD ARE COLOURED IN ACCORDANCE WITH THE FOLLOWING CODE.

BLUE: NEUTRAL  
BROWN: LIVE

As the colours of the wires in the mains lead of this apparatus may not correspond with the coloured markings identifying the terminals in your plug, proceed as follows:

The wire which is coloured BLUE must be connected to the terminal which is marked with the letter N or coloured BLACK.

The wire which is coloured BROWN must be connected to the terminal which is marked with the letter L or coloured RED.

Under no circumstances must either of the above wires be connected to the earth terminal of a three pin plug.

DEXIBELL

**DEXIBELL**  
is a brand of

PROEL SPA  
(Worldwide Headquarters)  
Via alla Ruenia, 37/43  
64027 Sant'Omero (TE) - ITALY  
Tel. +39 0861 81241  
Fax +39 0861 887865  
P.I. 00778590679  
N.Reg.AEE IT 0802000002762

[info@dexibell.com](mailto:info@dexibell.com)  
[www.dexibell.com](http://www.dexibell.com)

VIVO H7/H3 - OM/E Ver. 2.00

