



McIntosh Laboratory, Inc. 2 Chambers Street Binghamton, New York 13903-2699 Phone: 607-723-3512 www.mcintoshlabs.com

XR100
Loudspeaker System
Owner's Manual



WARNING - TO REDUCE RISK OF FIRE OR ELECTRICAL SHOCK, DO NOT EXPOSE THIS EQUIPMENT TO RAIN OR MOISTURE.

NO USER-SERVICEABLE PARTS INSIDE. REFER SERVICING TO QUALIFIED PERSONNEL.

To prevent the risk of electric shock, do not remove cover or back. No user-serviceable parts inside.

IMPORTANT SAFETY INSTRUCTIONS!

PLEASE READ THEM BEFORE OPERATING THIS EQUIPMENT.

1. Read these instructions.
2. Keep these instructions.
3. Heed all warnings.
4. Follow all instructions.
5. Do not use this apparatus near water.
6. Clean only with a non-abrasive dry soft cloth.
7. Install in accordance with the manufacturer's instructions.
8. **This Loudspeaker is capable of producing extremely high sound pressure levels, even when connected to amplifiers of moderate power output. User caution is advised. Ear protection is recommended when playing at high volumes as continued exposure to high sound pressure levels can cause permanent hearing impairment or loss. The use of a Sound Level Pressure Meter will greatly aid in determining when high volume levels are occurring.**
9. Do not install near any heat sources such as radiators, heat registers, stoves, or other apparatus (including amplifiers) that produce heat.
10. Only use attachments/accessories specified by the manufacturer.
11. Use only with the cart, stand, tripod, bracket, or table specified by the manufacturer, or sold with the apparatus. When a cart is used, use caution when moving the cart/apparatus combination to avoid injury from tip-over. 
12. Refer all servicing to qualified service personnel. Servicing is required when the apparatus has been damaged in any way, liquid has been spilled or objects have fallen into the apparatus, the apparatus has been exposed to rain or moisture, does not operate normally, or has been dropped.
13. Do not expose this equipment to dripping or splashing and ensure that no objects filled with liquids, such as vases, are placed on the equipment.
14. **WARNING: When this Loudspeaker is connected to an amplifier that is Powered On, the connection terminals may have hazardous live voltages present with a risk of electric shock.**
15. **CAUTION: This Loudspeaker weighs 68.5 pounds (31.1 kgs). It requires two or more persons to safely move the Loudspeaker.**

Thank You

Your decision to own this McIntosh XR100 Loudspeaker System ranks you at the very top among discriminating music listeners.. You now have “The Best.” The McIntosh dedication to “Quality,” is assurance that you will receive many years of listening enjoyment from this unit.

Please take a short time to read the information in this manual. We want you to be as familiar as possible with all the features and functions of your new McIntosh.

Please Take A Moment

The serial number, purchase date and McIntosh Dealer name are important to you for possible insurance claim or future service. The spaces below have been provided for you to record that information:

Serial Number: _____

Purchase Date: _____

Dealer Name: _____

Technical Assistance

If at any time you have questions about your McIntosh product, contact your McIntosh Dealer who is familiar with your McIntosh equipment and any other brands that may be part of your system. If you or your Dealer wish additional help concerning a suspected problem, you can receive technical assistance for all McIntosh products at:

McIntosh Laboratory, Inc.
2 Chambers Street
Binghamton, New York 13903
Phone: 607-723-3512
Fax: 607-724-0549

Copyright 2012 © by McIntosh Laboratory, Inc.

Customer Service

If it is determined that your McIntosh product is in need of repair, you can return it to your Dealer. You can also return it to the McIntosh Laboratory Service Department. For assistance on factory repair return procedure, contact the McIntosh Service Department at:

McIntosh Laboratory, Inc.
2 Chambers Street
Binghamton, New York 13903
Phone: 607-723-3515
Fax: 607-723-1917

Table of Contents

Safety Instructions	2
Thank You and Please Take a Moment.....	3
Technical Assistance and Customer Service	3
Table of Contents, General Information and Connector/Cable Information	3
Introduction and Performance Features.....	5
Dimensions	6-7
Unpacking the Loudspeaker and Attaching the Feet.....	8
Installation	8-9
How to Connect using a single Amplifier	10-11
How to Connect using two Amplifiers	12-13
Specifications.....	14
Packing Instruction.....	15

General Information

Caution: The XR100 weight is 68.5 pounds (31.1 kg). It requires two or more persons to safely handle the Loudspeaker System.

1. For additional connection information, refer to the owner’s manual(s) for any component(s) connected to the XR100 Loudspeaker.

2. The design of the XR100 Loudspeaker took into account the acoustic characteristics of the Front Panel Grille and it should be attached to the Loudspeaker for the best sonic performance.
3. If there is an obvious lack of high, mid or low frequencies after extended periods of overdrive, the Protection Device(s) may have activated. These devices will automatically reset when the volume level is greatly reduced until the output of the affected Loudspeaker Driver(s) returns to normal.
4. When discarding the unit, comply with local rules or regulations. Batteries should never be thrown away or incinerated but disposed of in accordance with the local regulations concerning battery disposal.
5. For additional information on the XR100 and other McIntosh Products please visit the McIntosh Web Site at www.mcintosh-labs.com.



Connector/Cable Information

Power Control Connectors

The XR100 Power Control Jacks (IN/OUT) receive and pass on an ON/OFF signal from +5 to +12 volts. An additional connection passes on Meter Illumination Control for compatible Power Amplifiers. The 1/8 inch stereo mini phone plug connects to a McIntosh Preamplifier or A/V Control Center Power Control Output.

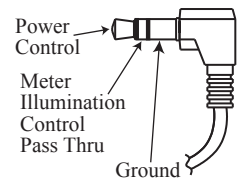



Introduction

McIntosh Acoustic Engineers have achieved in the design of the XR100 Loudspeaker System, a level of high performance. The XR100 provides superior spaciousness sound reproduction with unusual sound stage depth in a full range system.

The XR100 utilizes a three-quarter inch Titanium Dome Tweeter and 10 two inch Midrange Inverted Titanium Dome Drivers. Refer to figures 1 and 2. Since the audio power is distributed among all the drivers, each driver does not have to work as hard, resulting in greater power handling capability, dramatic reduction in distortion and greater dynamic range.

The Low Frequency Section of the System consists of a newly designed six inch Woofer. Refer to figure 3.



Figure 1



Figure 2



Figure 3

The four Woofers incorporate McIntosh's Patented LD/HP¹ Magnetic Circuit Design. Finite Element

¹LD/HP Pat. No 5,151,943

Analysis and testing resulted in a design concept which utilizes a pair of aluminum shorting sleeves in the magnetic circuit. Refer to figure 4. The sleeves greatly reduce the negative influence of the fluctuating voice coil field on the permanent magnet field. This results in lower distortion due to more linear magnetic flux in the voice coil

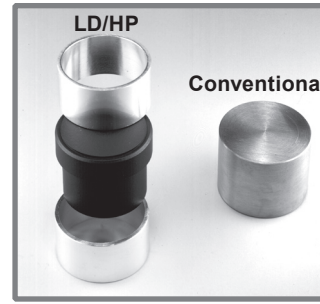

Figure 4

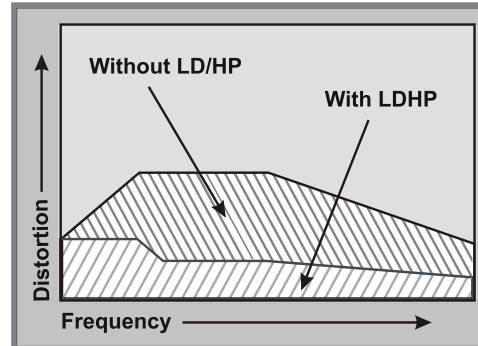

Figure 5

gap. Refer to figure 5. Additional benefits are less volume compression due to improved heat transfer through the sleeves and a cooler operating voice coil. Both measurements, as well as critical listening, reveal ten times less distortion than previous designs. A good example of this low distortion is incredible smoothness and clarity in the reproduction of the human voice.

The Crossover Network used in the XR100 Loudspeaker System is designed to ensure an even frequency response over the entire audible range. The Second Order Designed Network utilizes Capacitors and Inductors with high current capacity. Refer to figure 6. The XR100 uses low loss (DCR) Inductors in the

crossover network. The type of Inductor used in each section of the crossover network has been chosen for high linearity, even at high power levels. This prevents distortion of the music at any frequency. The Capacitors used are the low loss (ESR) types. The Network also utilizes self resetting high current PTC Fuses to provide an extra measure of protection.

The enclosure is an important part of the XR100 Loudspeaker System. It has multiple front to back and side to side internal braces to form a dampened rigid Loudspeaker enclosure. The Loudspeaker's small footprint allows for a variety of different placements in a room.

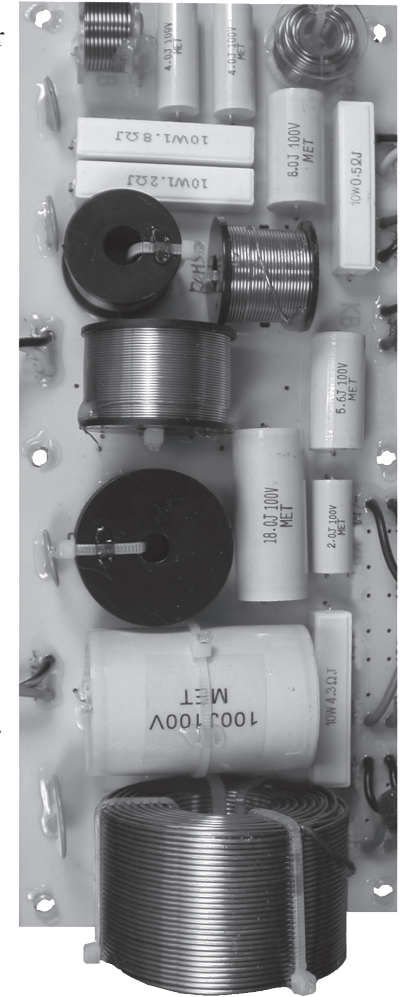

Figure 6

Performance Features

• **Woofers with Patented LD/HP® Technology**

The McIntosh Low Frequency Loudspeaker Elements feature the patented LD/HP Magnetic Circuit Design. This design, when compared to conventional Loudspeaker Drivers, reduces distortion significantly. It also increases power handling and efficiency.

The rear vent through the magnetic assembly offers improved heat dissipation. The die cast basket has an open air area under the voice coil/spider assembly to prevent displacement noise. The polypropylene cone with a rubber surround has a four layer copper voice coil and is rigid to perform as a near perfect air piston.

All together these advances in woofer design construction and materials produce the very important first several octaves of music, with a high degree of accuracy and superb transient response. This performance level rivals woofers twice the size of the XR100 woofer.

• **Neodymium-Iron-Boron Alloy Magnets**

The 10 two inch Midrange Drivers and the three-quarter inch Dome Super Tweeter all use this Alloy. The Neodymium-Iron-Boron Alloy has the highest flux density per unit of volume. This allows for a smaller physical size driver and thus closer driver to driver placement for improved dispersion.

• **Dual Midrange Crossover Points**

There are several benefits when using multiple Midrange drivers. First, there is a substantial increase in power handling capacity far greater than a single larger diameter midrange driver.

Second, due to mutual acoustic coupling there is an increase in output volume while at the same time a reduction in audible distortion. Eight of the 10 Midrange Drivers reproduce the lower two octaves of midrange

frequencies. The remaining two Midrange Drivers reproduce the upper two octaves of midrange frequencies and are located directly adjacent to the tweeter. This maintains wide dispersion with a stable sound image throughout the upper midrange frequencies.

• **Low Harmonic and Intermodulation Distortion**

The XR100 Loudspeaker System is capable of reproducing the full dynamic range of a symphony orchestra with very low audible distortion of any kind.

• **Low Frequency Port**

The XR100 Loudspeaker System utilizes a vertical port with a rear opening to increase bass output, reduce distortion and improve the overall efficiency of the Loudspeaker.

• **High Power Handling**

The Loudspeaker Elements and Crossover Components of the XR100 are all chosen for use with amplifiers up to 600 watts, yet can be driven with a 75 watt amplifier.

• **Loudspeaker Protection**

The XR100's built-in speaker protection incorporates four automatic resetting solid-state devices in the crossover network. One protects the tweeters, one each for the low and upper midrange drivers and one for the woofers.

• **Superior Imaging**

Locating the Super Tweeter between the multiple Midrange drivers generates a symmetrical polar response for superior imaging. The Midrange and Super Tweeter Drivers are precisely aligned on the precision machined mounting plate of 5/8 inch thick aluminium with a Brushed Champagne Gold Finish.

• **Versatile Operation**

In addition to the regular connections, the XR100 Loudspeaker System provides separate connections for Bi-Amplification and Bi-Wiring hookups.

• **McIntosh Custom Binding Posts**

McIntosh Patent Gold Plated Output Terminals deliver high current output. They accept large diameter wire and spade lugs. Banana plugs may also be used.

• **Power Control**

The Power Control Input supplies power to illuminate the XR100 McIntosh Logo and Power Control Output supplies power for remote turn-on of additional Components.

• **Loudspeaker Enclosure**

The XR100 Loudspeaker enclosure is constructed with non-parallel internal sides to reduce internal standing waves. It has multiple front to back and side to side internal braces to form a dampened rigid Loudspeaker enclosure. The XR100 is available in various real wood veneers with a high gloss polyester finish.

• **Loudspeaker Grille**

The custom designed molded Loudspeaker Front Grille exhibits nearly perfect Acoustic Transparency and is secured to the Loudspeaker Enclosure using Neodymium Magnets.

• **Solid State Front Panel Logo Illumination**

The even Illumination of the Front Panel Logo is accomplished by the combination of custom designed Light Diffusers and extra long life Light Emitting Diodes (LEDs).



Dimensions

The following dimensions can assist in determining the best location for your XR100.

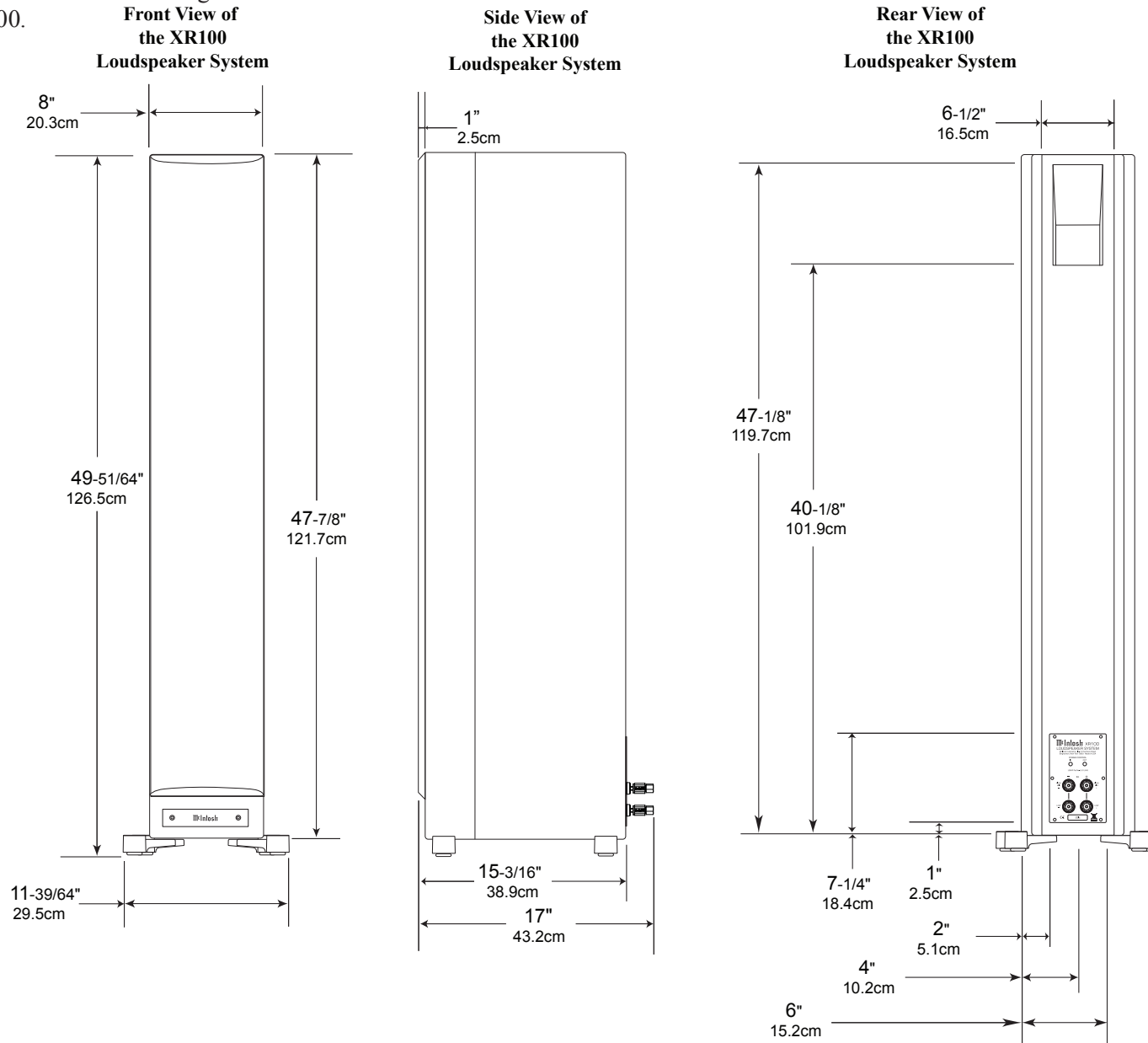

Front View of
the XR100
Loudspeaker System

Top View
of the XR100
Loudspeaker System

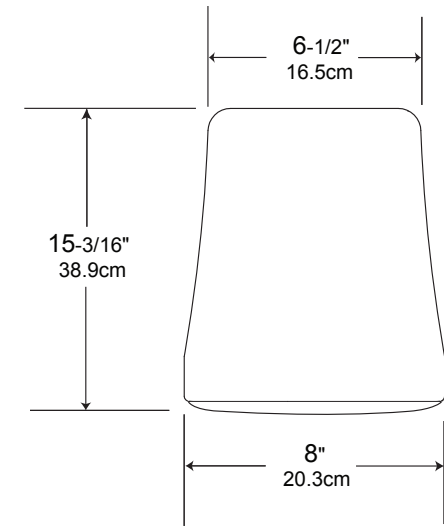
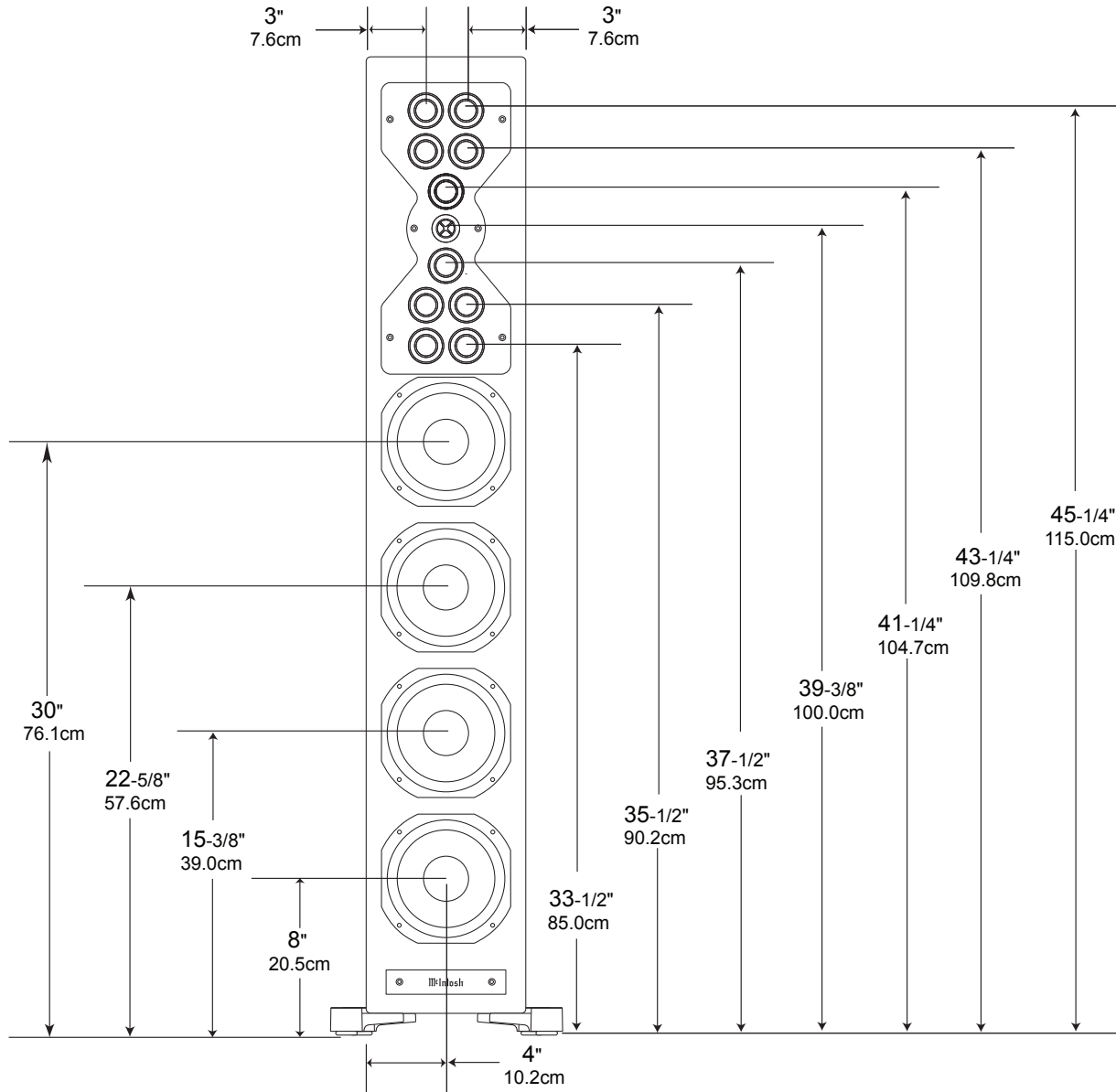

Unpacking the Loudspeaker and Attaching the Feet

Caution: The XR100 feet are packed separate from the Loudspeaker. It is very important to install the four feet on the bottom of the Loudspeaker. This will greatly prevent possible injury to small children and family pets. If the Loudspeaker is to be installed into custom cabinetry the feet need not be attached to the Loudspeaker.

To protect the fine finish of the XR100 Loudspeaker System during the installation process, it is advisable to prepare a suitable area. A freshly vacuumed carpeted area covered with a soft, clean fabric, such as a large bed linen or blanket would be suitable.

It is recommended that the Professionals at your McIntosh Dealer, who are skilled in all aspects of installation and operation, install the XR100 Loudspeaker System and any associated audio equipment.

Note: Refer to illustration on page 15 for unpacking the loudspeaker.

1. Orient the XR100 shipping carton with the lettering on the outside of the carton oriented upward.
2. Carefully cut open the shipping carton sealing tape and open the carton flaps.
3. Remove the accessory box containing the Loudspeaker Feet (including Glides and Tiptoes) along with mounting bolts.
4. Remove the Loudspeaker System with top, center and bottom foam pads by lifting up on the rear of the Loudspeaker and place it along side the shipping carton on the prepared flat surface.
5. Release the Loudspeaker and the box containing the Grille from the foam caps and set them aside.



Glides



Tiptoes

6. Close the top flaps of the shipping carton and place the top and bottom foam pads on top of the carton. Refer to figure 7A for the next several steps.

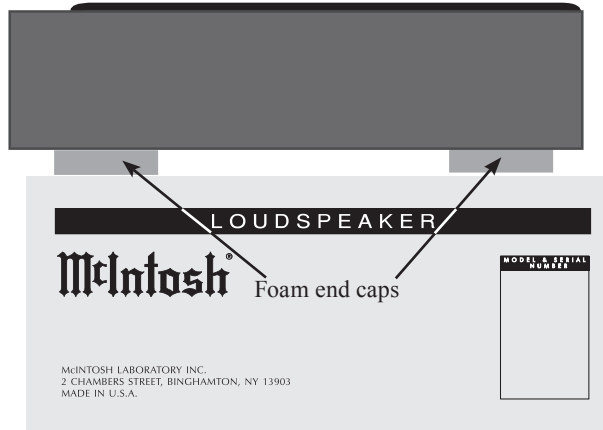

Figure 7A

7. Carefully remove the protective fiber cover from the Loudspeaker System so as not to mar the finish. Then remove the protective plastic film wrap from the Loudspeaker Cabinet.
8. Place the just removed protective fiber cover on top of the shipping carton/foam end caps.
9. Place the Loudspeaker System, with the front facing up, on top of the protective fiber cover.
10. Remove the feet and bolts from the accessory box and the Allen Wrench from the Owner's Manual plastic sleeve.
11. Using the supplied wrench and bolts attach the four feet to the Loudspeaker. Refer to figure 7B.

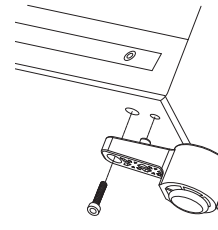

Figure 7B

Note: If the XR100 is to be installed into custom cabinetry it is advisable to protect the finish of the Loudspeaker bottom with felt pads or equivalent protection.

12. Attach the four Glides or Tiptoes into the tapped holes in the bottom of the XR100 feet.
13. Stand the Loudspeaker upright and place it in the desired location. The Glides or Tiptoes can be independently adjusted to compensate for uneven flooring or to aim the loudspeakers upward or downward.

Note: Retain the shipping carton, foam packing material and fiber cover for possible future use.

The XR100 Loudspeaker Grille is secured to the Loudspeaker Cabinet with magnetic fasteners.

14. Orient the Loudspeaker Grille so the word "TOP" (located on the inside of the Grille Frame) is pointing upward. Refer to figure 8. Next place the Loudspeaker Grille onto the Front of the Loudspeaker Cabinet, making sure to align the Grille Top with the Top of the Cabinet.

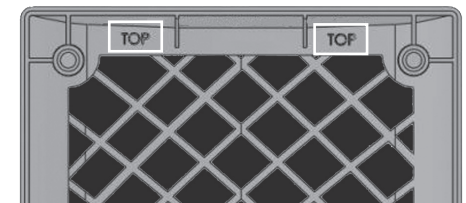

Figure 8

Installation

Loudspeaker Placement

Loudspeaker placement in a room can greatly affect performance. The XR100 Loudspeaker is designed for both Music and Home Theater Systems. The optimal method for selecting speaker locations includes the use of a real time spectrum analyzer operated by an experienced system installer. An uncompromising installation would take into consideration the floor, wall and ceiling coverings, the type and placement of furniture and can even include the architectural design of the room and its construction materials. In those instances where placement in the room is fixed, an environmental equalizer may be needed to restore proper musical balance.

Placement near a wall, corner, floor, ceiling or any intersecting surfaces will reinforce or diminish some bass frequencies. The bass frequencies that are altered by placement in a particular location is dependent on the dimensions of the room. If professional measurement equipment is not available, listen to the Loudspeaker. Try various locations by listening to music containing continuous bass and finding a location where there is an over all musical balance in the sound and the bass content does not dominate.

The XR100's Smooth Frequency Response may be altered by a large object(s) located in the sound waves path or by locating the Loudspeaker too close to a side wall. There should be an unobstructed area in front of the Loudspeaker of at least 30 degrees either side from the center axis for the best performance. Refer to figure 9.

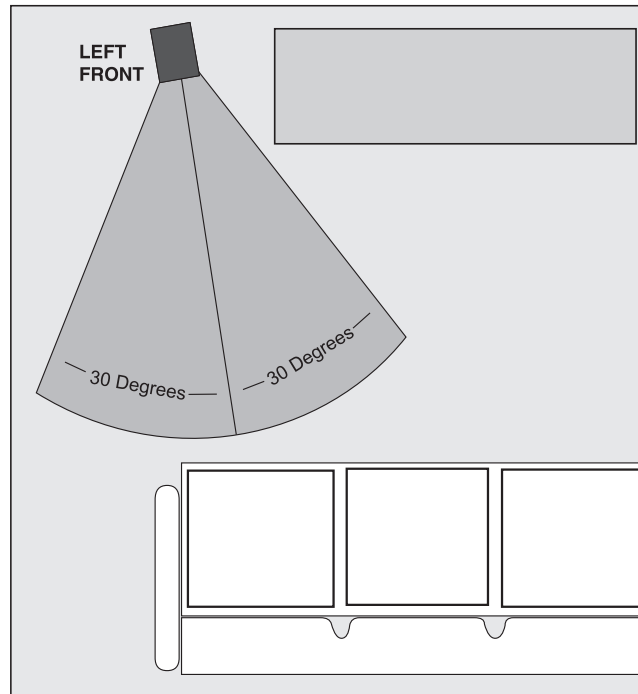

Figure 9

Locating Loudspeakers for use in Home Theater

In a Home Theater application, the placement of Left and Right Front Loudspeakers can be limited by such considerations as the size and location of the video monitor. The locating suggestions in the “for use in a Music System” section can still be helpful as a starting place. Refer to figure 10.

Locating Loudspeakers for use in a Music System

When used in a Music System, the distance between the Loudspeakers and the listener to the Loudspeakers should form an equilateral or an acute isosceles triangle. If the speakers are too far apart relative to the listener, some imaging can be lost. Refer to figure 11.

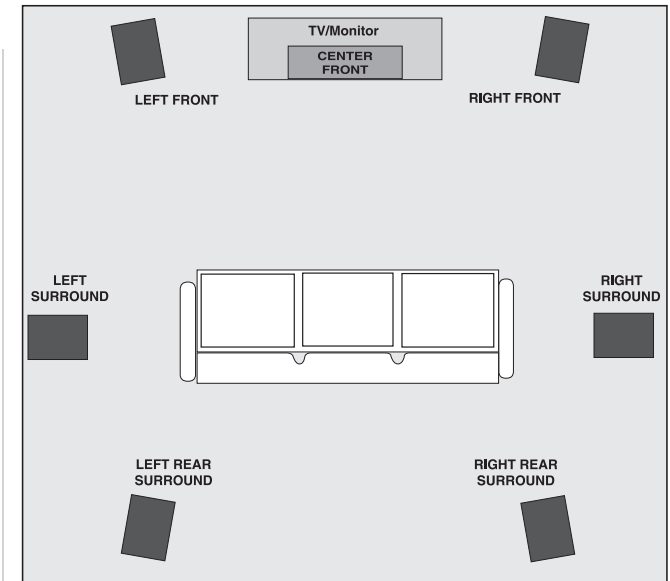

Figure 10

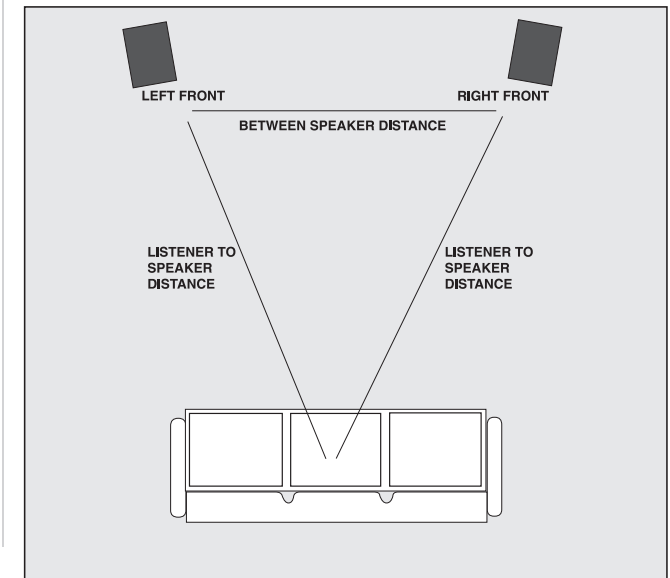
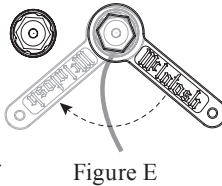
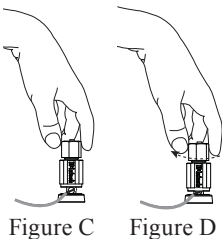
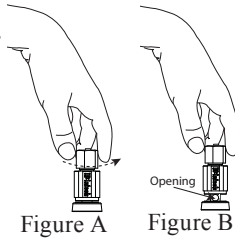

Figure 11

Input Terminals

When connecting the Loudspeaker Hookup Cables to the XR100 Loudspeaker Input Terminals please follow the steps below:

1. Rotate the end of the Input Terminal Post counterclockwise until an opening appears. Refer to figures A and B.
2. Insert the Loudspeaker hookup cable into the Input Terminal Post opening or the cable spade lug around the center post of the Input Terminal. Refer to figure C.
3. Rotate the end of the Input Terminal Post clockwise until it is finger tight. Refer to figure D.
4. Place the supplied McIntosh Wrench over the end of the Input Terminal and rotate it one quarter of a turn (90°) to secure the Loudspeaker Cable Connection. **Do not over tighten.** Refer to figure E.



How to Connect using a single Amplifier

Caution: The AC Power Cord should not be connected to the Amplifier until after the Loudspeaker Connections have been made. Failure to observe this could result in Electric Shock.

1. For illumination of the XR100 Loudspeaker McIntosh Name Plate, connect a Power Control Cable from the Power Amplifier (or Integrated Amplifier) Power Control Output 1 to the XR100 POWER CONTROL IN.
2. Connect a second Power Control Cable from the first XR100 Loudspeaker POWER CONTROL OUT to the next XR100 POWER CONTROL IN.

3. Connect any additional McIntosh Loudspeakers with illuminated McIntosh Name Plates in a similar manner, as outlined in steps 1 and 2.

When connecting a XR100 Loudspeaker to an amplifier it is very important to use cables of adequate size, so there is little to no power loss in the cables. The size is specified in Gauge Numbers or AWG (American Wire Gauge). The smaller the Gauge number, the larger the wire size:

Loudspeaker Cable Distance vs Wire Gauge Guide			
Loudspeaker Impedance	25 feet (7.62 meters) or less	50 feet (15.24 meters) or less	100 feet (30.48 meters) or less
2 Ohms	12AWG	10AWG	8AWG
4 Ohms	14AWG	12AWG	10AWG
8 Ohms	16AWG	14AWG	12AWG

4. Prepare Loudspeaker cables by choosing one of the methods below:

Bare wire cable ends:

Carefully remove sufficient insulation from the cable ends, refer to figures 12, 13 & 14. If the cable is stranded, carefully twist the strands together as tightly as possible.

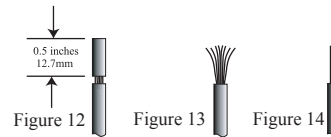

- Notes:*
1. If desired, the twisted ends can be tinned with solder to keep the strands together.
 2. The prepared bare wire cable ends may be inserted into spade lug connectors.
 3. Banana plugs are for use in the United States and Canada only.

Banana Plugs are for use in the United States and Canada only:

5. Attach the previously prepared bare wire cable ends into the banana plugs and secure the connections. Refer to figure F.
6. Rotate the top of the Output Terminal Post clockwise until it is finger tight. Refer to figure G. Then using the McIntosh Wrench, rotate the top of the Output Terminal one quarter of a turn (90°). **Do not over tighten.** Refer to figure E.
7. Referring to figure H and the illustration on the next page, connect the Loudspeaker hookup cables with banana plugs into the hole at the end of the terminal to the XR100 Negative (-) LOW Input Terminal and Positive (+) LOW Input Terminal.

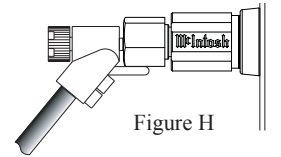
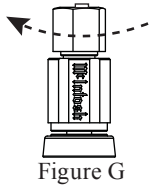
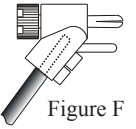

Note: It is important to maintain the correct polarity at both ends of the Loudspeaker cables.

8. Connect the other end of the Loudspeaker cables coming from the XR100 Negative (-) and Positive (+) LOW Input Terminals to the Left Channel Negative (-) and Positive (+) 8 Ω Output Terminal of the Amplifier.
9. Refer to steps 7 thru 8 to connect the second XR100 Loudspeaker in a similar manner to the Amplifiers.

Spade Lug or Wire Connections:

10. Referring to the illustration connect the Loudspeaker hookup cables to the XR100 Negative (-) Input Terminal and Positive (+) Input Terminal. Insert the spade lug connector or prepared section of the cable end into the Input Terminal side access hole, and tighten the Input Terminal cap until the cable is firmly clamped into the terminals so the lugs or wire cannot slip out. Refer to figures 15 and 16.

Note: It is important to maintain the correct polarity at both ends of the Loudspeaker cables.

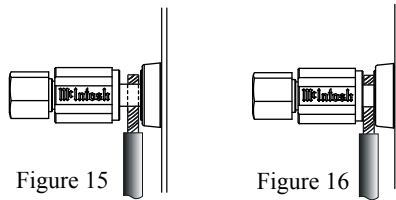
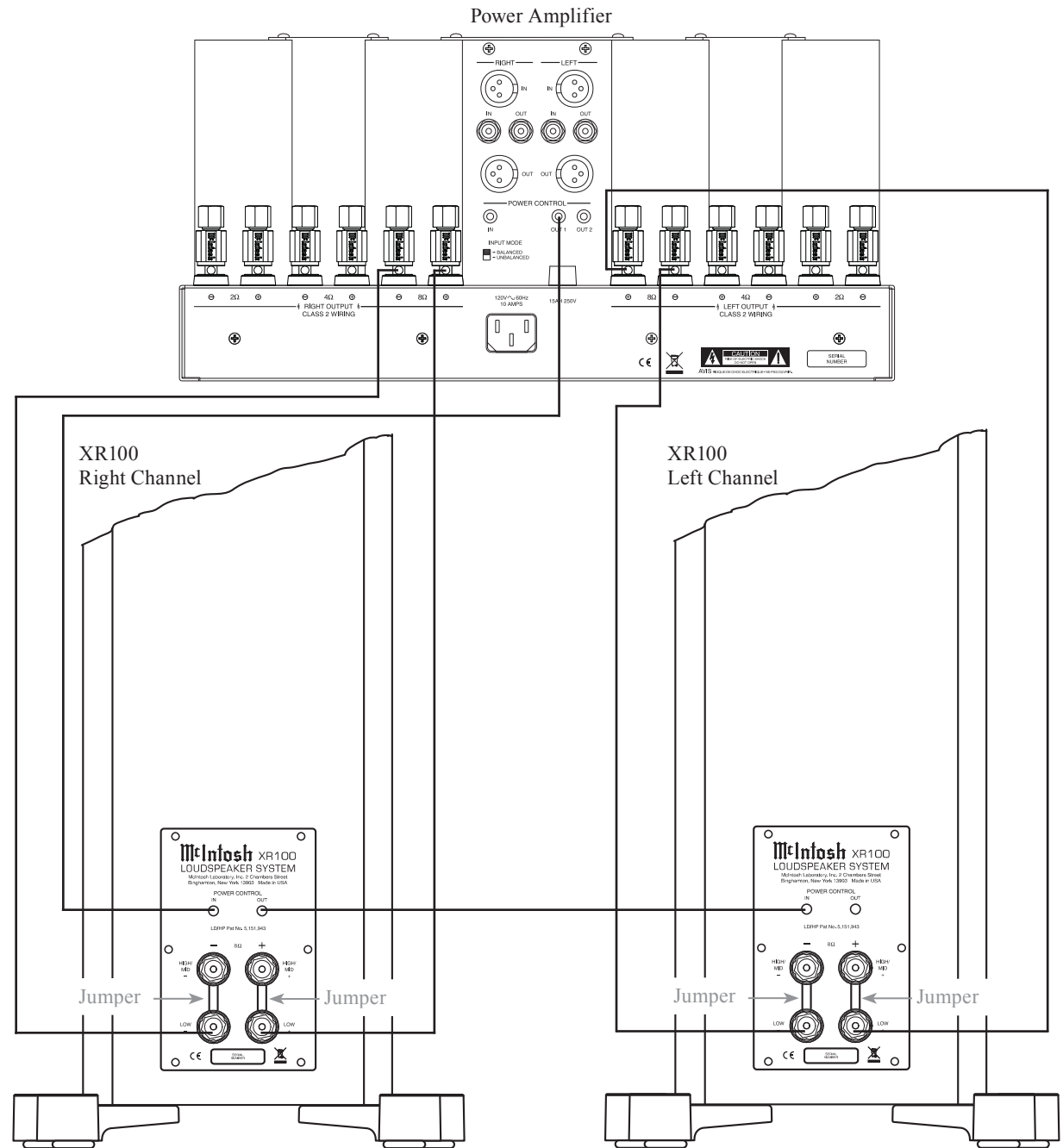

Figure 15

Figure 16

11. Connect the other end of Loudspeaker cables coming from the XR100 Negative (-) LOW Input Terminal to the Left Channel COM (-) 8 Ω Output Terminal of the Amplifier.
12. In a similar manner, connect the Loudspeaker cables coming from the second XR100 Positive (+) LOW Input Terminal to the Left Channel 8 Ω (+) Output Terminal of the Amplifier.
13. Connect the second XR100 Loudspeaker in a similar manner to the Amplifiers Right Channel Terminals.



Input Terminals

When connecting the Loudspeaker Hookup Cables to the XR100 Loudspeaker Input Terminals please follow the steps below:

1. Rotate the end of the Input Terminal Post counterclockwise until an opening appears. Refer to figures A and B.
2. Insert the Loudspeaker hookup cable into the Input Terminal Post opening or the cable spade lug around the center post of the Input Terminal. Refer to figure C.
3. Rotate the end of the Input Terminal Post clockwise until it is finger tight. Refer to figure D.
4. Place the supplied McIntosh Wrench over the end of the Input Terminal and rotate it one quarter of a turn (90°) to secure the Loudspeaker Cable Connection. **Do not over tighten.** Refer to figure E.

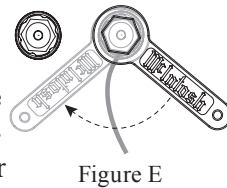
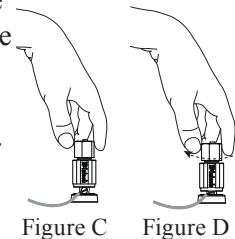
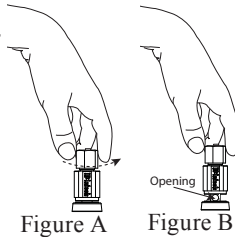

How to Connect using two Amplifiers

Caution: The AC Power Cord should not be connected to the Amplifier until after the Loudspeaker Connections have been made. Failure to observe this could result in Electric Shock.

For illumination of the XR100 Loudspeaker McIntosh Name Plate follow the steps below:

1. Connect a Power Control Cable from Power Amplifier One, Power Control Output 1 to Power Amplifier Two Power Control IN.
2. Connect a Power Control Cable from Power Amplifier Two, Power Control Output 1 to the XR100 POWER CONTROL IN.

3. Connect a second Power Control Cable from the first XR100 Loudspeaker POWER CONTROL OUT to the next XR100 POWER CONTROL IN.
4. Connect any additional McIntosh Loudspeakers with illuminated McIntosh Name Plates in a similar manner, as outlined in steps 1 and 2.

Note: When the XR100 Loudspeaker System is driven by two amplifiers, the output levels of different model amplifiers connected to the Loudspeaker System must be adjusted to achieve a proper balance between the low and midrange/high frequencies reproduced. This adjustment is best achieved through the use of audio test equipment operated by a qualified installer.

When connecting a XR100 Loudspeaker to an amplifier it is very important to use cables of adequate size, so there is little to no power loss in the cables. The size is specified in Gauge Numbers or AWG (American Wire Gauge). The smaller the Gauge number, the larger the wire size:

Loudspeaker Cable Distance vs Wire Gauge Guide			
Loudspeaker Impedance	25 feet (7.62 meters) or less	50 feet (15.24 meters) or less	100 feet (30.48 meters) or less
2 Ohms	12AWG	10AWG	8AWG
4 Ohms	14AWG	12AWG	10AWG
8 Ohms	16AWG	14AWG	12AWG

5. Prepare Loudspeaker cables by choosing one of the methods below:

Bare wire cable ends:

Carefully remove sufficient insulation from the cable ends, refer to figures 12, 13 & 14. If the cable is stranded, carefully twist the strands together as tightly as possible.

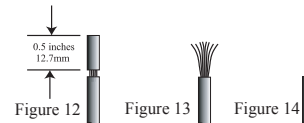

- Notes:*
1. If desired, the twisted ends can be tinned with solder to keep the strands together.
 2. The prepared bare wire cable ends may be inserted into spade lug connectors.
 3. Banana plugs are for use in the United States and Canada only.

Banana Plugs are for use in the United States and Canada only:

6. Remove the XR100 metal jumpers between the Negative (-) LOW and HIGH/MID Terminals and between the Positive (+) LOW and HIGH/MID terminals. Retain them for possible future use.
7. Attach the previously prepared bare wire cable ends into the banana plugs and secure the connections. Refer to figure F.
8. Rotate the top of the Output Terminal Post clockwise until it is finger tight. Refer to figure G. Then using the McIntosh Wrench, rotate the top of the Output Terminal one quarter of a turn (90°). **Do not over tighten.** Refer to figure E.
9. Referring to figure H and the illustration on the next page, connect the Loudspeaker hookup cables with banana plugs into the hole at the end of the XR100 LOW Negative (-) and Positive (+) Input Terminals. Then connect cables to the XR100 HIGH/MID Negative (-) and Positive (+) Input Terminals.

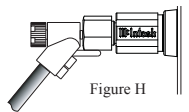
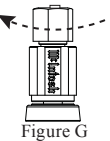
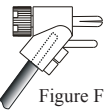

Note: It is important to maintain the correct polarity at both ends of the Loudspeaker cables.

10. Connect cables from the XR100 LOW Terminals to the Left Channel Negative (-) and Positive (+) 8 Ω Output Terminals of Power Amplifier Two. Then connect cables from the XR100 HIGH/MID

Terminals to the Left Channel Negative (-) and Positive (+) 8 Ω Output Terminals of Power Amplifier One.

11. Connect the other Loudspeaker in a similar manner to the Right Channel Output Terminals of the Power Amplifiers.

Spade Lug or Wire Connections:

12. Remove the XR100 metal jumpers between the Negative (-) LOW and HIGH/MID Terminals and between the Positive (+) LOW and HIGH/MID terminals. Retain them for possible future use.
13. Referring to the illustration connect the Loudspeaker hookup cables to the XR100 Negative (-) Input Terminal and Positive (+) Input Terminal. Insert the spade lug connector or prepared section of the cable end into the Input Terminal side access hole, and tighten the Input Terminal cap until the cable is firmly clamped into the terminals so the lugs or wire cannot slip out. Refer to figures 15 and 16. Then connect cables to the XR100 HIGH/MID Negative (-) and Positive (+) Input Terminals.

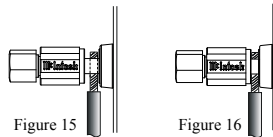

Note: It is important to maintain the correct polarity at both ends of the Loudspeaker cables.

14. Connect cables from the XR100 LOW Terminals to the Left Channel Negative (-) and Positive (+) 8 Ω Output Terminals of Power Amplifier Two. Then connect cables from the XR100 HIGH/MID Terminals to the Left Channel Negative (-) and Positive (+) 8 Ω Output Terminals of Power Amplifier One.
15. Connect the other Loudspeaker in a similar manner to the Right Channel Output Terminals of the Power Amplifiers.

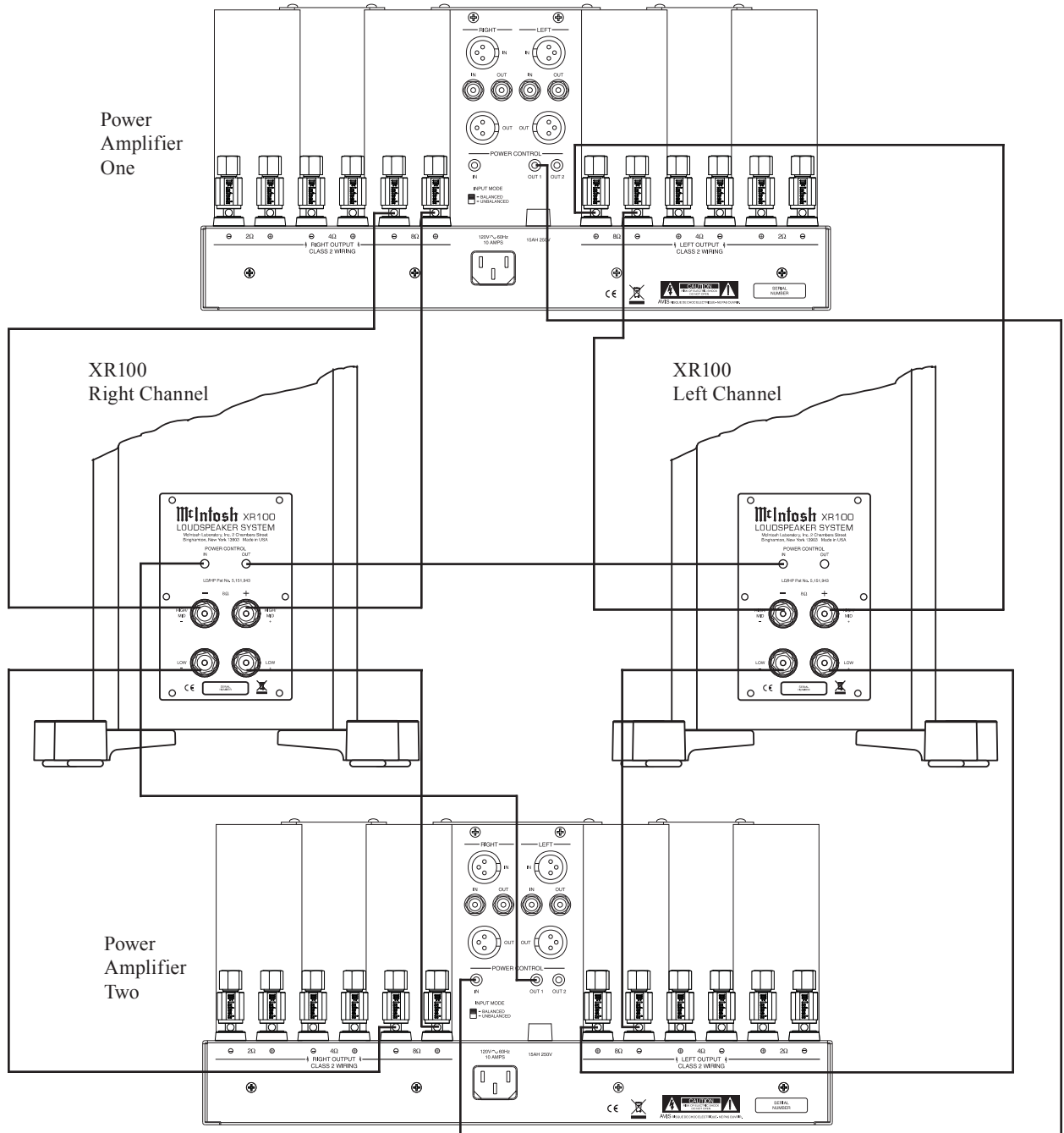



Specifications

System Driver Complement

Four 6 inch Woofers (incorporating LD/HP¹)
Ten 2 inch Titanium Inverted Dome Midranges
One 3/4 inch Titanium Dome Tweeter

Impedance

8 ohms Nominal

Frequency Response

30Hz - 45,000Hz

Sensitivity

87 dB (2.83V/1m equivalent)

Crossover Frequencies

300Hz
2,000Hz
8,000Hz

Recommended Power Range

75 Watts to 600 Watts

Maximum Power Handling

600 Watts

McIntosh Logo Power Requirement

5VDC to 12VDC at 1mA

General Specifications

Enclosure Finish

Available in various real wood veneers with
a high gloss polyester finish

Grille Finish

Black Knit Cloth

Overall Dimensions

Height is 51 inches (129.5cm)
Width is 8 inches (20.3cm)
Depth is 18-1/2 inches (46.9cm) including cables and
connectors

Weight

68.5 pounds (31.1 kg) net
83 pounds (37.6 kg) in shipping carton

Shipping Carton Dimensions

Height is 55-3/4 inches (141.6cm)
Width is 14-5/8 inches (37.1cm)
Depth is 21-5/8 inches (54.9cm)

¹LD/HP Pat. No 5,151,943

Packing Instructions

In the event it is necessary to repack the equipment for shipment, the equipment must be packed exactly as shown below. To protect the finish of the Loudspeaker it is advisable to wrap the Loudspeaker Cabinet with a durable plastic film. Then place wrapped Loudspeaker into the protective fiber cover, before inserting it into the shipping carton.

Use the original shipping carton and interior parts only if they are all in good serviceable condition. If a shipping carton or any of the interior part(s) are needed, please call or write Customer Service Department of McIntosh Laboratory. Please see the Part List for the correct part numbers.

Quantity	Part Number	Description
1	03451500	Shipping carton
1	034520SP	Top foam pad
1	034519SP	Center foam pad
1	034518SP	Bottom foam pad
1	320426SP	Accessory carton
1	03453500	Corrugated filler
1	034524SP	Protective fiber cover

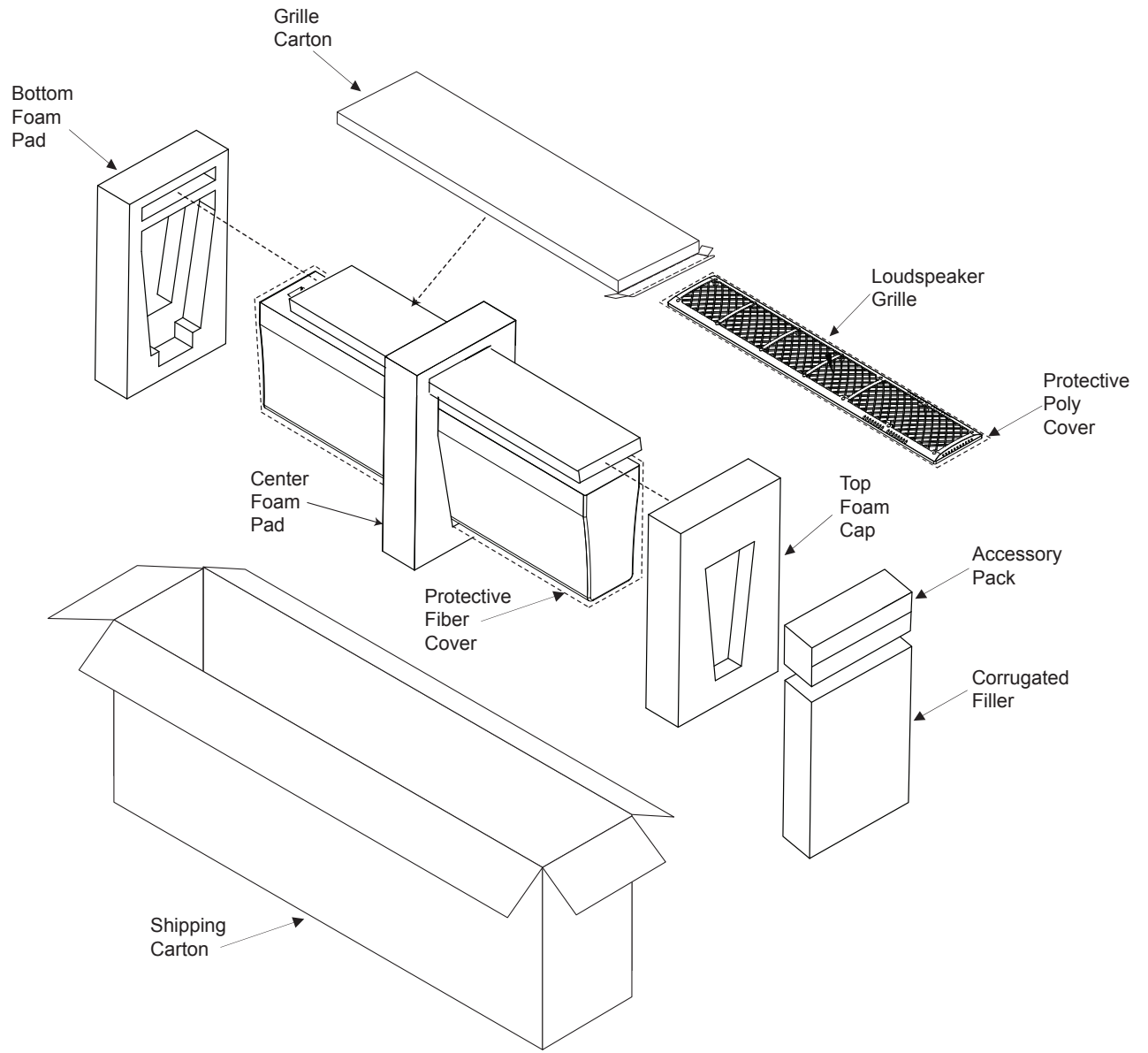



McIntosh Laboratory, Inc.
2 Chambers Street
Binghamton, NY 13903
www.mcintoshlabs.com

The continuous improvement of its products is the policy of McIntosh Laboratory Incorporated who reserve the right to improve design without notice.
Printed in the U.S.A.