

DIGITAL PIANO

Owner's Manual

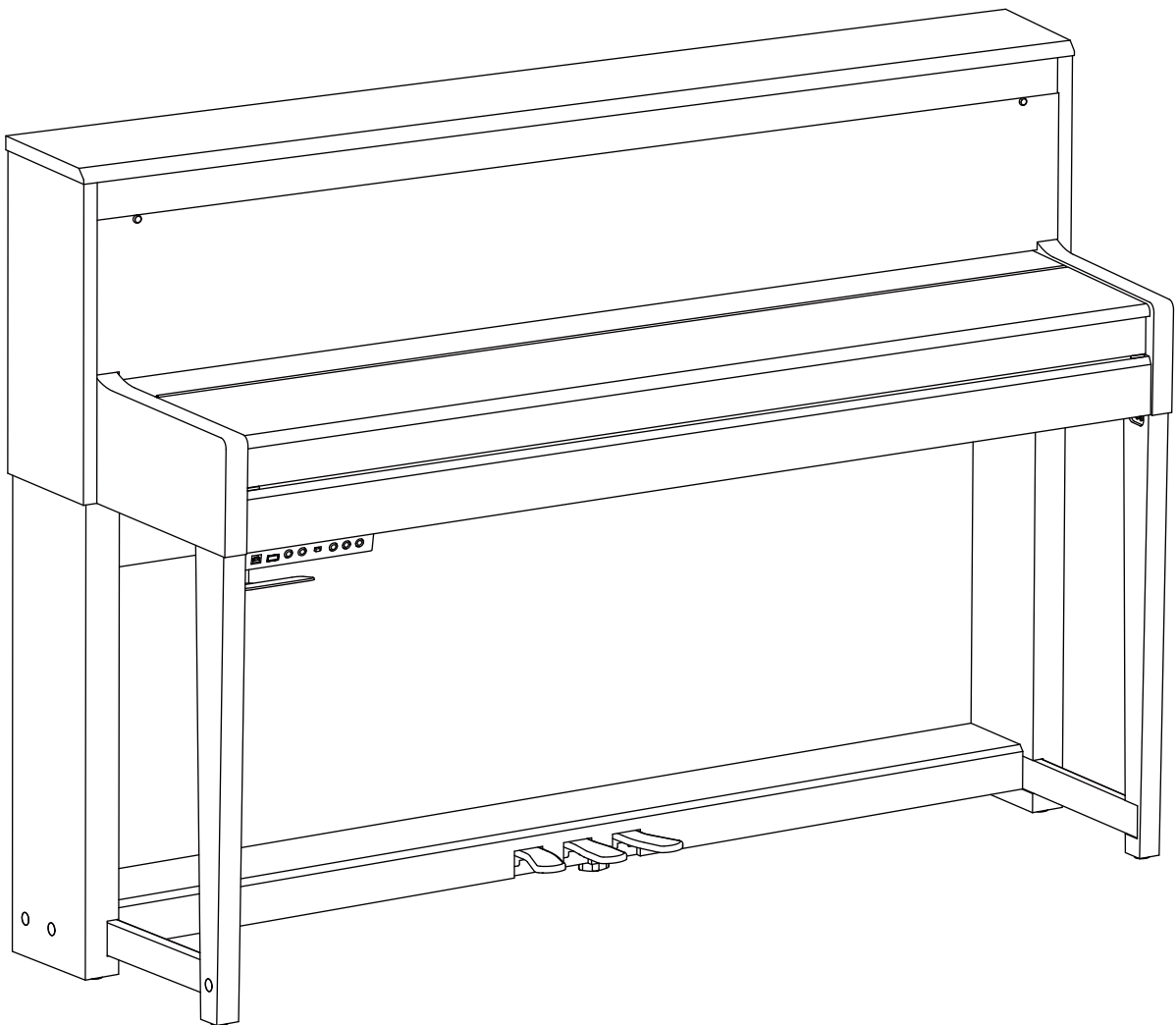

INFORMATION FOR YOUR SAFETY!

THE FCC REGULATION WARNING (for USA)

This equipment has been tested and found to comply with the limits for a Class B digital device, pursuant to Part 15 of the FCC Rules.

These limits are designed to provide reasonable protection against harmful interference in a residential installation. This equipment generates, uses, and can radiate radio frequency energy and, if not installed and used in accordance with the instructions, may cause harmful interference to radio communications. However, there is no guarantee that interference will not occur in a particular installation. If this equipment does cause harmful interference to radio or television reception, which can be determined by turning the equipment off and on, the user is encouraged to try to correct the interference by one or more of the following measures:

- Reorient or relocate the receiving antenna.
- Increase the separation between the equipment and receiver.
- Connect the equipment into an outlet on a circuit different from that to which the receiver is connected.
- Consult the dealer or an experienced radio/TV technician for help.

Unauthorized changes or modification to this system can void the user's authority to operate this equipment.

CAUTION

The normal function of the product may be disturbed by Strong Electro Magnetic Interference. If so, simply reset the product to resume normal operation by following the owner's manual. In case the function could not resume, please use the product in other location.

PRECAUTIONS

PLEASE READ CAREFULLY BEFORE PROCEEDING

Please keep this manual in a safe place for future reference.

Power Supply

Please connect the designated AC adaptor to an AC outlet of the correct voltage.

Do not connect it to an AC outlet of voltage other than that for which your instrument is intended.

Unplug the AC power adaptor when not using the instrument, or during electrical storms.

Connections

Before connecting the instrument to other devices, turn off the power to all units. This will help prevent malfunction and / or damage to other devices.

Location

Do not expose the instrument to the following conditions to avoid deformation, discoloration, or more serious damage:

Direct sunlight
Extreme temperature or humidity
Excessive dusty or dirty location
Strong vibrations or shocks
Close to magnetic fields

Interference with other electrical devices

Radios and televisions placed nearby may experience reception interference. Operate this unit at a suitable distance from radios and televisions.

Cleaning

Clean only with a soft, dry cloth.
Do not use paint thinners, solvents, cleaning fluids, or chemical-impregnated wiping cloths.

Handling

Do not apply excessive force to the switches or controls.

Do not let paper, metallic, or other objects into the instrument. If this happens, remove the electric plug from the outlet. Then have the instrument inspected by qualified service personnel.

Disconnect all cables before moving the instrument.

Panel & Display Description	
Front Panel.....	4
IO Panel.....	5
Pedal.....	5
Display.....	5
Setup	
Component Guide.....	6
Setup Guide.....	7
Power Supply and Power Switch.....	8
Adjusting the Master Volume.....	8
Connections	
Connecting a pair of Headphones.....	9
Connecting a Microphone.....	9
Connecting a Mixer or an Audio Equipment.....	9
Connecting an MP3/CD Player.....	9
Using a USB Flash Drive.....	9
Playing Voices	
Playing Voices.....	10
Playing Two Voices Simultaneously.....	10
Playing Different Voices with Both Hands.....	11
Adjusting the Brilliance of Voice.....	11
Piano Mode.....	11
Play the Piano with a Friend.....	11
Metronome.....	11
Play Back Songs	
Play Back Preset Songs.....	13
Play Back Songs from a USB Flash Drive.....	13
Record Your Performance	
Record Your Performance with a USB Flash Drive...14	
Record Only the Keyboard Notes.....	14
Record with Accompaniment of a Preset Song.....	15
Function Menu	
Common Settings.....	16
Play Different Keys at the Same Position.....	17
Shift the Pitch of Keyboard by Octave.....	17
Set the Touch Sensitivity of the Keyboard.....	17
Set the Balance of Voice Layers and Song.....	17
Set the Time Signature for the Metronome.....	18
Select Different Speaker EQ.....	18
String Resonance.....	18
Add Reverb Effect to Your Performance.....	18
Add Chorus Effect to Your Performance.....	19
Add Vocal Effect to Microphone.....	19
Select the Song Loop mode for Song Playback.....	19
Other Settings.....	20
Set MIDI OUT Channel.....	20
Set the Auto Power Off Time.....	20
Set the System Date and Time.....	21
Reset to System Preset	21
Work with Computer or Smart Device	
Connect with a Computer.....	22
Connect with a Smart Device.....	22
Troubleshooting	23
Specifications	23
Appendix	
Voice List.....	24
Song List.....	25

Panel Description

Front Panel

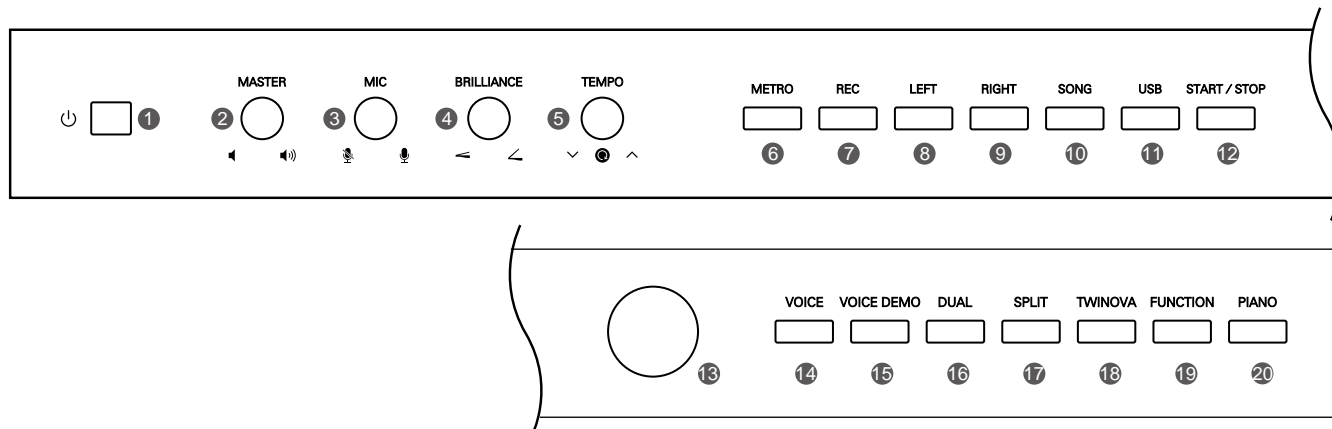

1. POWER SWITCH

Turn the power on or off. *Page 8*

2. [MASTER VOLUME] knob

Adjust the master volume. *Page 8*

3. [MIC VOLUME] knob

Adjust the microphone volume. *Page 9*

4. [BRILLIANCE] knob

Adjust the brilliance of the piano. *Page 11*

5. [TEMPO] knob

Spin to adjust the tempo, press to reset the tempo. *Page 12*

6. [METRO] button

Turn the metronome on/off. *Page 12*

7. [REC] button

Enter/Exit record mode. *Page 14*

8. [LEFT] button

Turn on or off the left-hand part when playing back a preset song. *Page 13*

9. [RIGHT] button

Turn on or off the right-hand part when playing back a preset song. *Page 13*

10. [SONG] button

Enter song mode. *Page 13*

11. [USB] button

Open the inserted USB flash drive. *Page 13*

12. [START/STOP] button

Start/stop playing a song. *P13*
Start recording a song. *P14*

13. DATA DIAL

Change the selected parameter value. *Page 10*

14. [VOICE] button

Enter the voice mode. If the "SPLIT" or "DUAL" function is on, press to switch between Voice L, Voice R1 and Voice R2. *Page 10*

15. [VOICE DEMO] button

Play back the VOICE DEMO of the current selected Voice. *Page 10*

16. [DUAL] button

Turn Voice R2 on. *Page 10*

17. [SPLIT] button

Turn Voice L on and split the keyboard into left and right voice areas. *Page 11*

18. [TWINOVA] button

Enter TWINOVA mode, which will enable two players to play the piano. *Page 12*

19. [FUNCTION] button

Press to open the Function menu. Or press and hold to open the system setting menu.
Press repeatedly to select a menu item to edit. *Page 16*

20. [PIANO] button

Enter the PIANO mode. *Page 11*

IO Panel

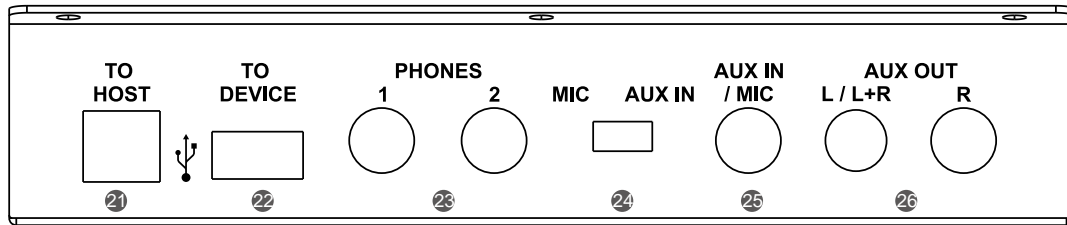

21. [USB TO HOST] terminal

Connect to a computer, smart device or other USB host device. *Page 22*

22. [USB TO DEVICE] port

Insert a USB flash drive. *Page 13*

23. [PHONE 1]/[PHONE 2] jacks

Connect to headphones. *Page 9*

24. [MIC]/[AUX IN] switch

MIC: Connect a microphone to [AUX IN]/[MIC] jack.

AUX IN: Connect an external audio player output to [AUX IN]/[MIC] jack. *Page 9*

25. [AUX IN]/[MIC] jack

Connect a microphone or the output of an audio device to this instrument. *Page 9*

26. [AUX OUT] jacks

Connect to the input of an external audio device, like an external mixer. *Page 9*

Pedal

27. Soft Pedal

Press this pedal to reduce the volume of the notes while you are playing.

28. Sostenuto Pedal

If you play a note or chord on the keyboard and press the pedal while holding the note(s), the notes will sustain as long as the pedal is held. However, all subsequent notes will not sustain.

29. Sustain Pedal

When you press and hold the pedal, all notes played on the keyboard have a longer and natural sustain.

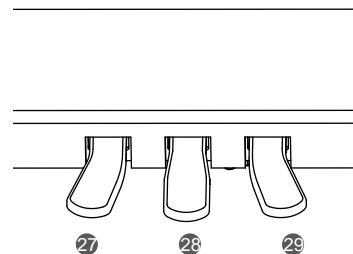

Display

1. Voice layer & voice number

2. Octave value

3. Transpose value

4. Tempo value

5. Voice name

6. Measure and beat length

7. Represent recording standby mode

8. Time signature

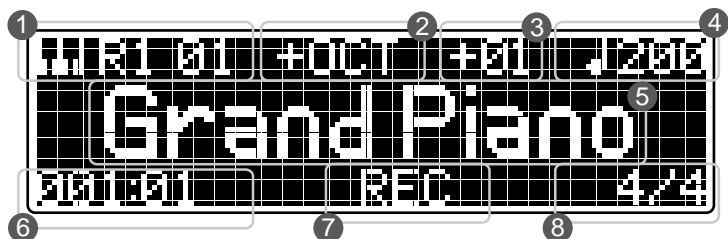

Setup

In this section, we are going to introduce information about setting up your instrument and preparing to play. Please go through this section carefully before turning the power on.

Component Guide

Before proceeding to assemble the stand, you may need to prepare a tool, such as a Philip's screwdriver (not supplied).

Check carefully that all parts (have been indicated with numbers) are included before following the instructions below.

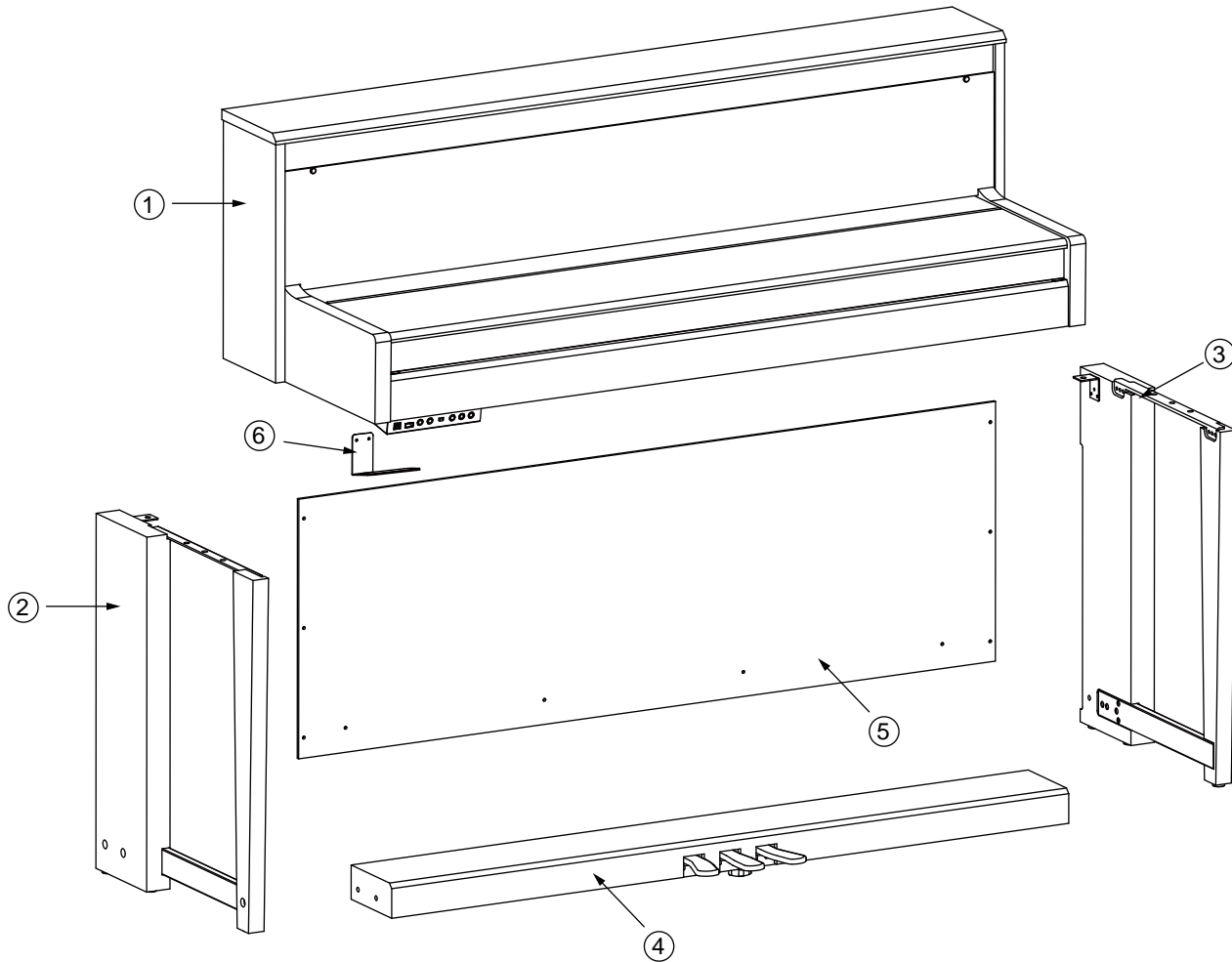

1	Piano body
2	Left stand board
3	Right stand board
4	Pedal box
5	Big back board
6	Earphone bracket
7	Hand Screw (2 pcs)
8	6x40CM "+"Screw
9	Screw cap (6 pcs)
10	Ø3x8BM "+"Screw (2 pcs)
11	Ø4x15PA "+"Screw (10 pcs)
12	Ø6x18BM "+"Screw
13	Earphone bracket
14	AC power adaptor



7



8



9



10



11



12



13

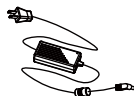

14

Setup Guide

Step 1: Using 4 PCS $\varnothing 6 \times 40 \text{CM}$ "+" Screw connect Left/Right stand board to Pedal box, finally cover 4 PCS screw cap on the screw hole.

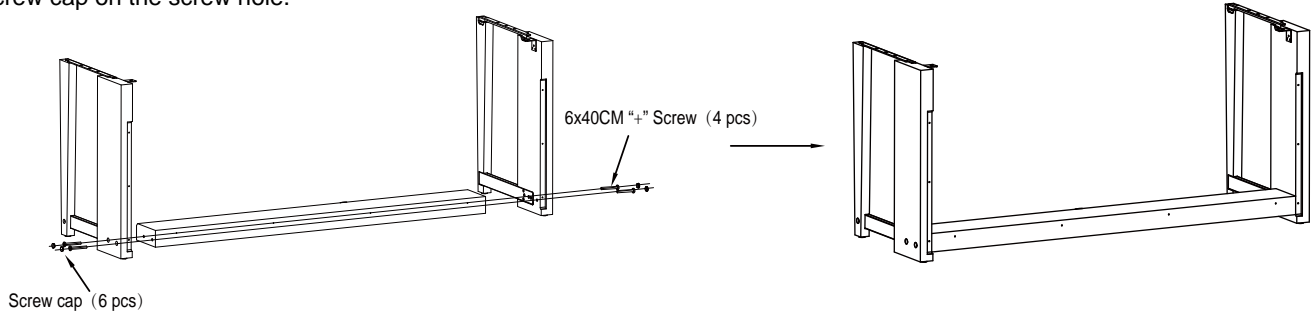

Step 2: As shown below, use 10 pcs 4x15 screws to fix big board with stand left/right board and pedal box.

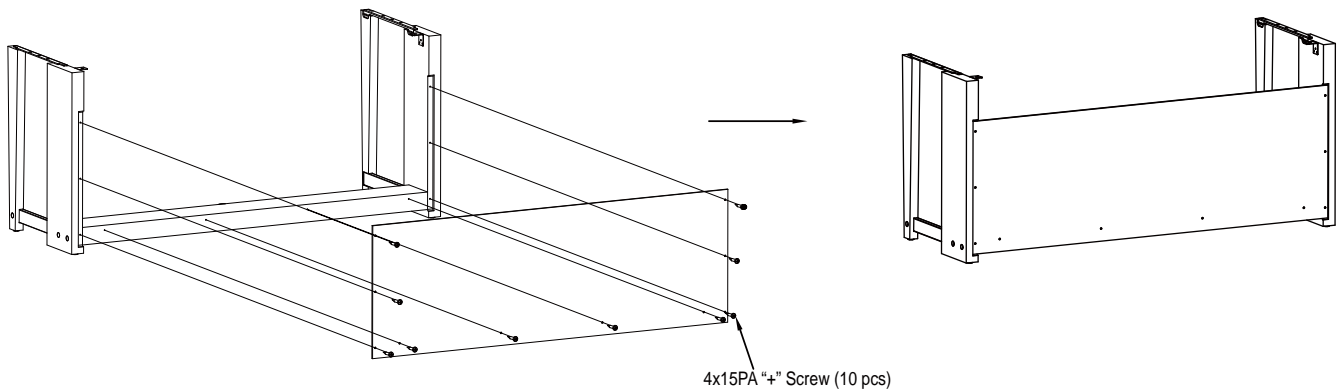

Step 3: Use 2 PCS Hand screw and 6 PCS $\varnothing 6 \times 18 \text{BM}$ "+" screw to connect Piano body to Piano feet as shown.

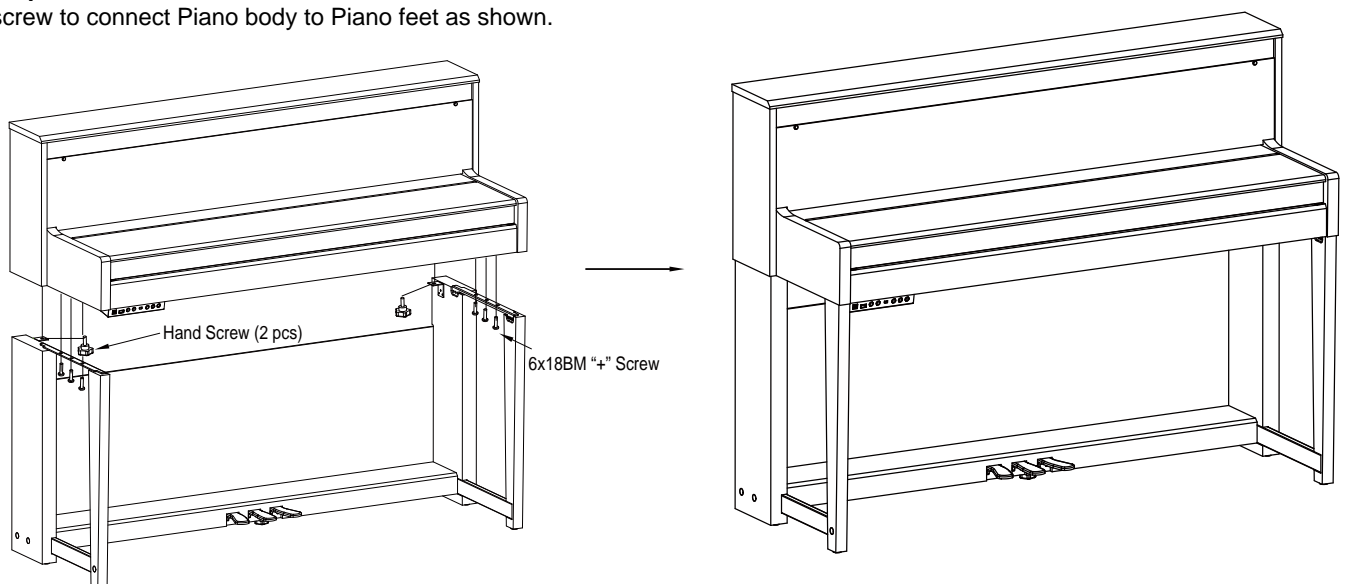

Setup

Step 4: Using 2 PCS Ø3x8 BM screw to connect earphone bracket to IO functionbox , then insert the Pedal line into the Pedal line socket under the Piano bottom, assembly completed.

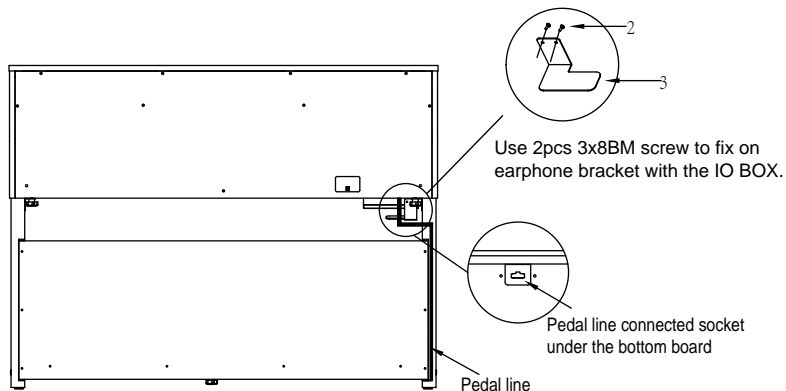

Step 5: Connect the power cord to the DC IN jack at the rear of the piano, and then plug it to an AC outlet. The installation is completed now. Turn on the power and enjoy the perfect performance.

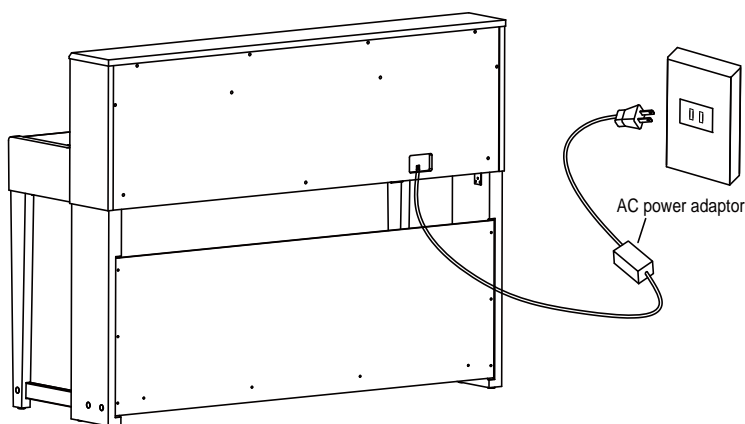

Power Supply and Power Switch

Before power on, make sure that the volumes of piano and all connected audio equipments are turned to the minimum value.

1. Plug the AC/DC adaptor into an AC outlet.
2. Press the [POWER SWITCH].
The LCD will display welcome interface which indicates the piano has powered on.
3. If you want to turn off the piano, press the [POWER SWITCH] again.

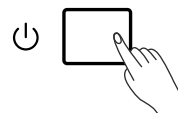

Note:

1. In order to save energy, we have designed the Auto Power Off function to this instrument. With this function, the instrument will be automatically powered off in 30 minutes if you do not take any operation on the instrument. For more details, please refer to **Function** chapter.
2. When the keyboard is not in use or in the time of thunderstorm, please disconnect the power for safety purpose.

Adjusting the Master Volume

Turn the [MASTER VOLUME] knob in a clockwise direction to increase the volume, and decrease it in an anti-clockwise direction.

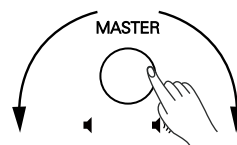

Connecting a pair of Headphones

We have designed two PHONES jacks for this instrument. Two standard pairs of stereo headphones can be plugged in here for private practice, monitoring or late-night playing.

PHONES Jack: when headphones are plugged into the jacks, you can only hear the sound from the headphones, as the internal stereo speaker system is automatically muted.

Note:

Do not listen with the headphones at high volume for long periods of time, considering that it may cause hearing loss.

Connecting a Microphone

You are the superstar! With this microphone function, enjoy singing with your keyboard performance. Or create a magic voice show with the preprogrammed voice effects.

1. To protect the speakers of the piano and your headphones, please turn the [MIC VOLUME] knob to the minimum level.
2. Set the [MIC/AUX IN] switch to "MIC" position.
3. Plug the microphone to [MIC/AUX IN] jack.
4. Gradually tuning the [MIC VOLUME] knob while singing with microphone till an appropriate level. You can also add voice effects to microphone. For details, please refer to **Function** chapter.

Connecting a Mixer or an Audio Equipment

Through an audio cord connect your piano to a keyboard amplifier, stereo sound system, a mixer, or recorder or other devices. Plug audio cord into the [AUX OUT] jack located at the bottom-left of keyboard then plug the other end of the cord into AUX IN of the amplifier.

Note:

To avoid damaging the speakers, please ensure that the volume has been set to the minimum level before connecting the power and other devices.

Connecting an MP3/CD Player

Connect the audio output of an MP3/CD player or other audio source to the stereo [MIC/AUX IN] jack located at the bottom-left of the keyboard. The input signal is mixed with the audio from the piano, which allows you to play along with the input music.

1. Turn the [MIC/AUX IN] switch to "AUX IN" position.
2. Plug one side of audio cord into [MIC/AUX IN] jack and the other end to MP3/CD player.

Using a USB Flash Drive

A USB flash drive can be used to save the real-time recorded song (MP3) and play back songs from a USB flash drive.

The instrument is compatible with 2GB to 128GB, FAT32 format USB flash drive, but do not support USB flash drive partition.

The instrument can play back MP3 and SMF MIDI files under the root directory of USB flash drive. Your recorded song will be saved under the root directory too.

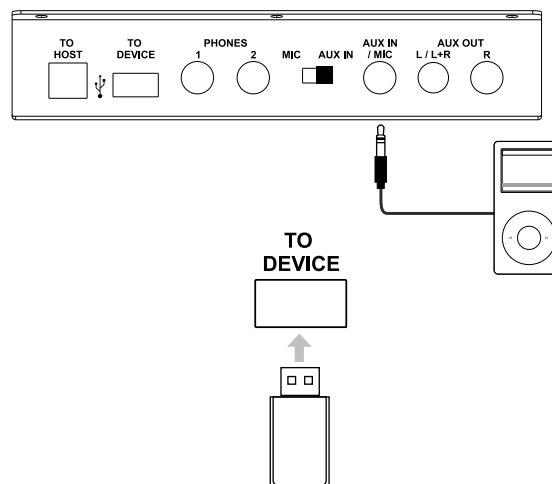
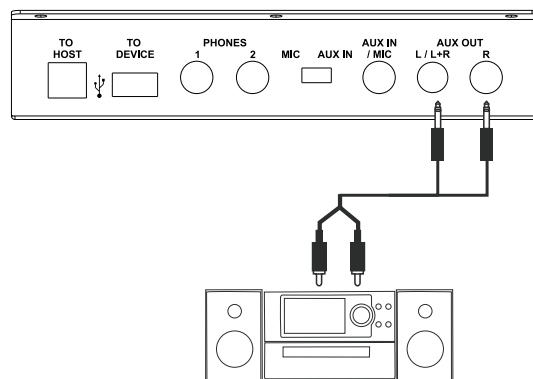
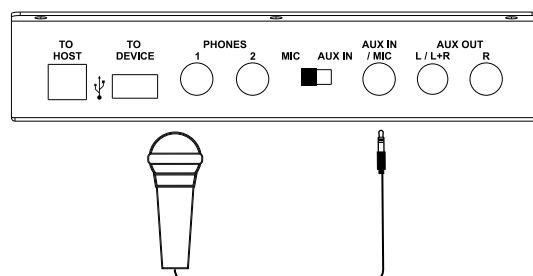
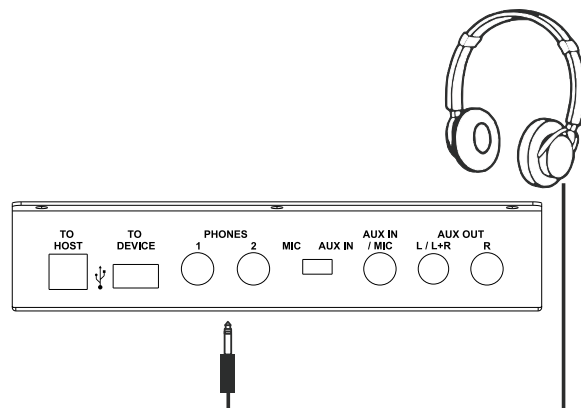

Playing Voices

The piano features 40 realistic preset voices (Please refer to the **Voice List**). You may also try the voice related functions like Reverb, Chorus in the **Function** menu to enrich your performance.

Playing Voices

1. Press the [VOICE] button.
The LCD displays currently selected voice name and number.
2. Use the data dial to select a voice.
3. Play the keyboard, the selected voice will be used.

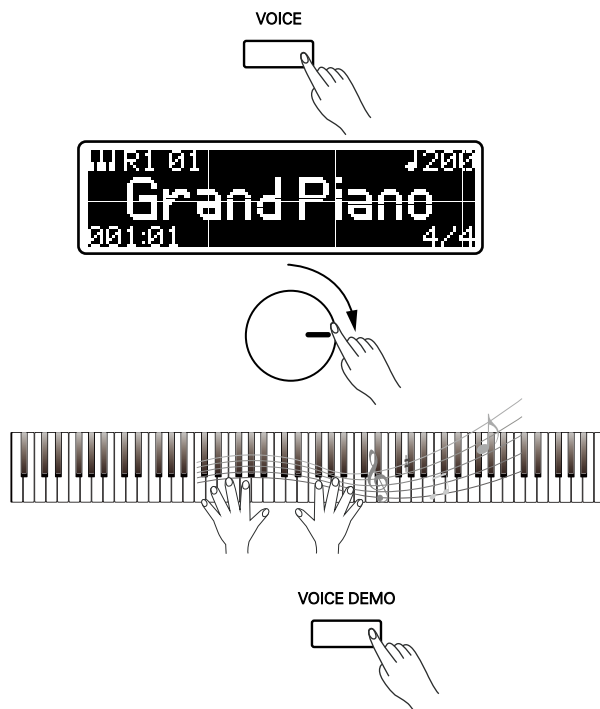

4. You may use the [VOICE DEMO] button to hear the demo of the selected voice.

Note:

When DUAL or LOWER is turned on, you can use the [VOICE] button to switch to Voice R2 or Voice L display to change the voice selections.

Playing Two Voices Simultaneously

Dual function allows you to play two different voices simultaneously to create a new sound. This will enrich your performance, as two different instruments are playing at the same time.

1. Press the [DUAL] button to turn Voice R2 on.
Play the keyboard; you can hear two different voices being played at the same time.
2. To change the voice combination, you can repeatedly press the [VOICE] button to switch between Voice R1 and Voice R2, and then use data dial to select the voice you need.
3. To turn Voice R2 off, please press the [DUAL] button again.

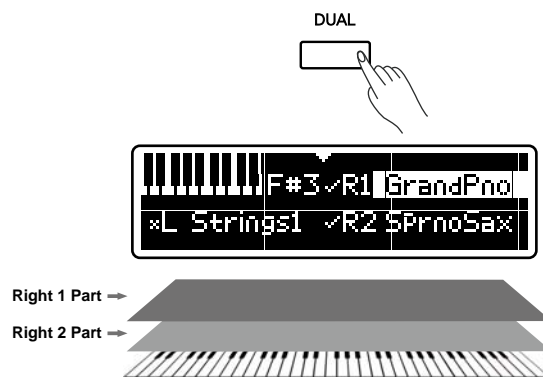

Playing Different Voices with Both Hands

The lower function splits the keyboard into right and left areas to create two different voices. The left area voice is lower voice, and you can allocate an appropriate split point on the keyboard.

1. Press [SPLIT] button to turn the lower function on.
Play the keyboard, you will find the keyboard has been split into two areas at F#3, each has its own voice selection.
2. To change the voice combination, you can press the [VOICE] button repeatedly to switch between Voice R1 and Voice L, then use the data dial to choose a different voice.
3. To turn the Voice L off, please press the [SPLIT] button again.

Split Point

Split point is the key which splits the keyboard into left hand and right hand areas. The default split point is F#3, you can set it to any key you want.

To change the split point, press and hold the [SPLIT] button, then play a key. The key you played will be used as the new split point.

Adjusting the Brilliance of Voice

If you need a brighter or warmer voice, you can try to change the brilliance.

Slowly turn the panel [BRILLIANCE] knob to an appropriate level, and play the keyboard to test the change.

Piano Mode

Just a single press on the [PIANO] button, the instrument will be turned into concert grand voice. All parameters will be optimized for piano performance.

To exit piano mode, you can press [VOICE] button to return to the voice display.

Note:

Dual, Split, and some other buttons will not be available in piano mode.

SPLIT

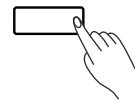

Split Point

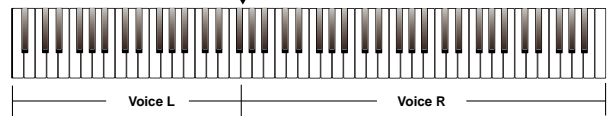

SPLIT

Hold

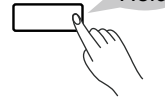

Split Point

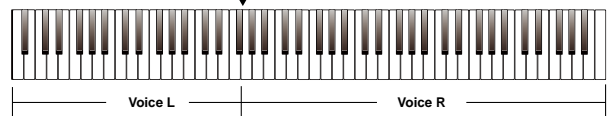

BRILLIANCE

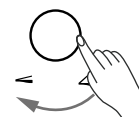

PIANO

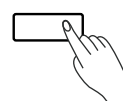

Playing Voices

Play the Piano with a Friend

If you want to play a song together with a friend, you can try the Twinova mode. The Twinova mode can split the keyboard into two areas which have the same pitch and voice.

1. Press [TWINOVA] button to enter Twinova mode. The keyboard will be split into two areas, the default split point is "F#4".

The pedal functions of Twinova:

Left Pedal: Notes played on the left part have a longer sustain.

Middle Pedal: Notes played on the left and right parts have a longer sustain.

Right pedal: Notes played on the right part have a longer sustain.

2. Besides the default split point F#4, you can shift the split point to "E3" by pressing the [SPLIT] or [TWINOVA] button. You can try them out and find the appropriate choice for your cooperation with your friend.

3. If you are ready to exit the Twinova mode, press the [VOICE] button to return to the voice mode.

Note:

Dual, Split, and some other buttons will not be available in Twinova mode.

Metronome

The metronome can help you to keep an accurate tempo when practicing and playing.

How to use a metronome?

1. Press the [METRO] button to turn the metronome on.
You will hear the "Ding Da Da Da..." sound plays with current tempo and time signature.
2. Press the [METRO] button again to stop the metronome.
To change the time signature of the metronome, please refer to **Function** menu for metronome beat settings.

Note:

The metronome sound will not be recorded, and it does not output from AUX OUT or USB AUDIO. It can be heard from the internal speakers and the connected headphones.

Change or Reset the Tempo

1. Turn the panel [TEMPO] knob to change the tempo value, range from 30 to 280 BPM.
2. Press down the [TEMPO] knob to reset the default tempo of currently selected song.

Tempo Marking

Press and hold the [TEMPO] knob for a while, release when you see the display changes to Tempo Marking.

You can see the corresponding marking of current tempo setting in this mode, so you can change the tempo to a certain marking defined in the sheet music.

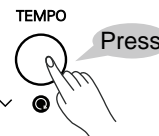
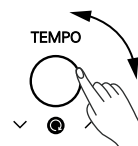
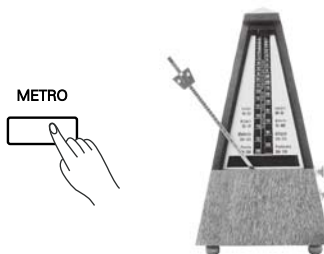
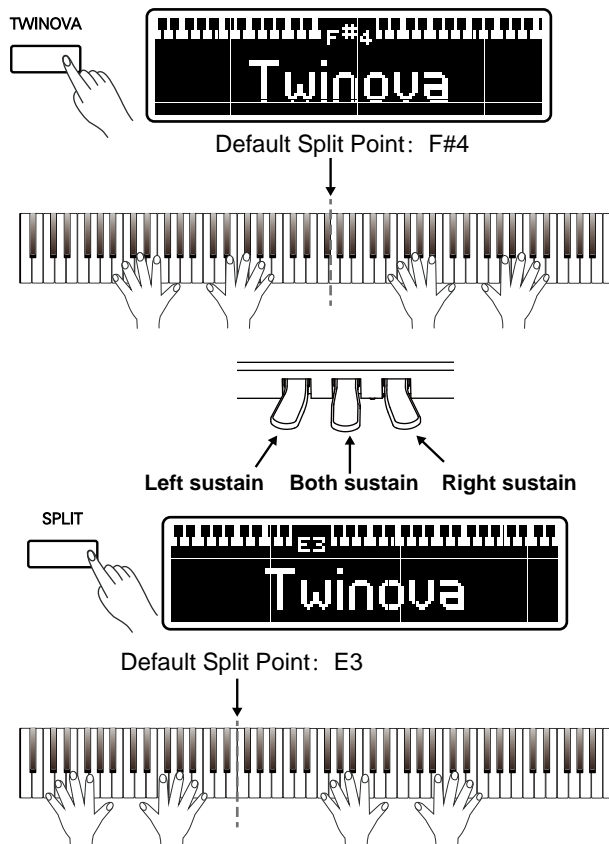

Play Back Songs

The piano has 90 preset classical songs of various genres. You can record and save the user song inside the piano. If a USB flash drive is connected, the piano can play back the MP3 and MIDI files from it.

Play Back Preset Songs

1. Press the [SONG] button, the LCD displays the selected song.
2. Use the data dial to select a song you want to play. If a user song is recorded, you will find it behind the preset songs.
3. Press the [START/STOP] button to start the playback.
4. Press the [LEFT] button to mute the left-hand track, then you can listen to the right-hand track and try to play the left-hand notes.

Or you can press the [RIGHT] button to mute the right-hand track; you may listen to the left-hand track and try to play the right-hand notes.

Pressing the muted part button again will cancel the mute.

5. Press the [START/STOP] button to stop the playback.

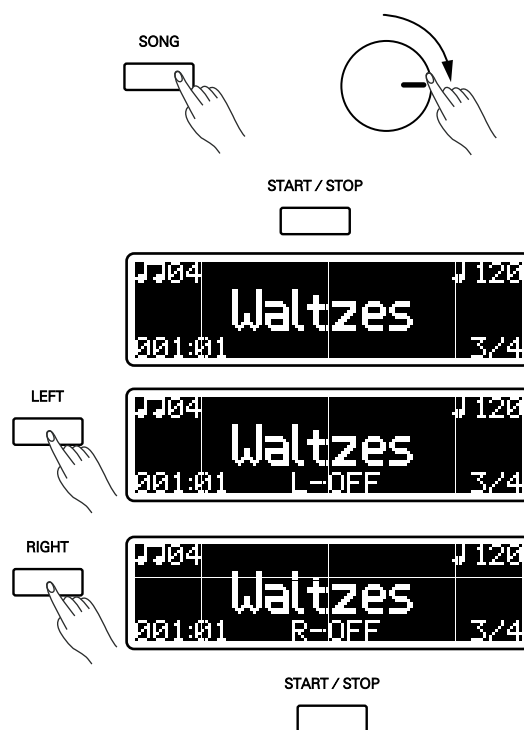

Play Back Songs from a USB Flash Drive

This piano can support USB flash drives from 2G to 128GB of FAT32 format. You can copy your favorite songs of MIDI or MP3 format to the root directory of the USB flash drive and play along with them.

1. Insert the USB flash drive into the [USB TO DEVICE] port which located at the bottom-left of the keyboard.
2. Press the [USB] button, the LCD will display the MIDI and MP3 files in the root directory
3. Use the data dial to select a song you want to play.
4. Press the [START/STOP] button to start playing the selected file.
5. Pressing the [START/STOP] button again will stop the playback.

Note:

You can loop all files in the root directory or loop the single song for the playback. Please refer to the **Function** menu, select a "Song Loop" mode as you want.

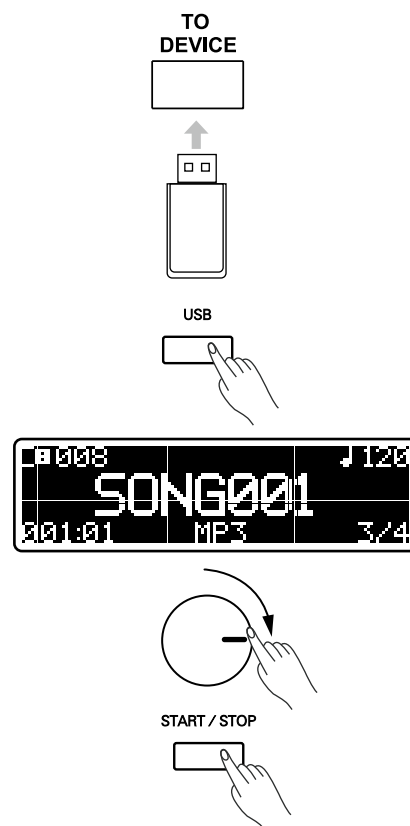

Record Your Performance

All notes you played on this keyboard can be recorded, you can play back the recorded user song anytime you need. You can turn the metronome on while recording; the metronome sound will not be recorded.

Record Your Performance with a USB Flash Drive

You may connect a USB flash drive to the piano before recording. Your performance will be recorded as a MP3 file and saved in the root directory of the USB flash drive.

The piano can support FAT32 USB flash drive. If your drive is not, you may receive a question from the display, asking for your permission to format the drive to FAT32. Please note that all data saved in the drive will be erased if you choose to format it.

If you don't use the USB flash drive for recording, your performance will be recorded to the internal memory of the piano as the user song. You will find it in the Song display.

Record Only the Keyboard Notes

1. Press the panel [REC] button, enter the standby mode.

If you choose not to use the USB flash drive, you may receive a question from the display, asking if you want to overwrite the existing internal user song or not.

If you press [RIGHT] button as "YES", the existing user song will be replaced by your new record. Press [LEFT] for "NO", this record operation will be canceled.

2. The "REC" icon starts flashing in the LCD indicating that the piano is ready to record. Press the [REC] button at this time will cancel recording.

3. Press the panel [START/STOP] button or play any note on the keyboard to start recording.

4. Press the panel [START/STOP] button or press the [REC] button again to stop recording.

The piano will automatically switch to the SONG or USB mode after your recorded performance is saved. Press the [START/STOP] button to listen to it.

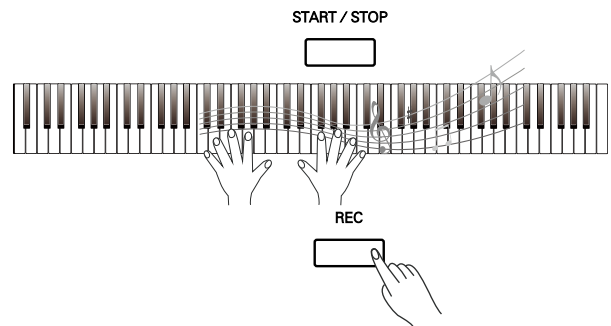
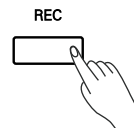

Record with Accompaniment of a Preset Song

If you want to record with accompaniment, do as the following procedures:

1. Press the panel [REC] and [METRO] buttons simultaneously, enter the standby mode.

If you choose not to use the USB flash drive, you may receive a question from the display, asking you if you want to overwrite the existing internal user song or not.

If you press [RIGHT] button as "YES", the existing user song will be replaced by your new record], Press [LEFT] for "NO", this record operation will be canceled.

2. Press the panel [START/STOP] button or play any note on the keyboard to start recording.

While recording, you can try to press the panel [LEFT] or [RIGHT] button to mute the corresponding part performance, and then you can play the muted part.

3. Press the panel [START/STOP] button or press the [REC] button again to stop recording.

The piano will automatically switch to SONG or USB mode after your recorded performance is saved. Press the [START/STOP] button to listen to it.

Note:

The recording procedure will automatically stop when the storage memory is full.

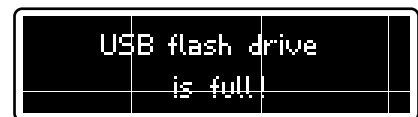
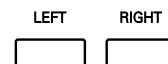
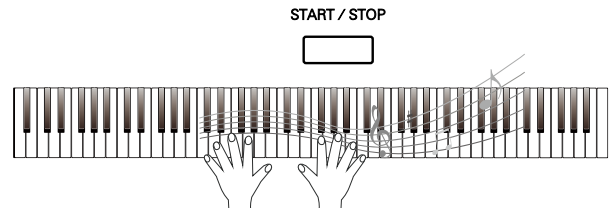
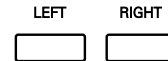
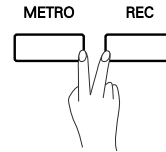

Function Menu

The function menu is a collection of the parameters of your piano. You can easily customize your configuration here.

Common Settings

1. Enter the common settings.
In the VOICE interface, press the [FUNCTION] button.
2. Select a parameter item.
Repeatedly press the [FUNCTION] button to select a parameter item.
Or you can use the data dial when keep holding the [FUNCTION] button pressed to quickly select a parameter item.
3. Change parameter value.
Use the data dial to change the selected parameter value.

FUNCTION

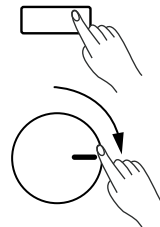

Detailed parameter items and their value range are shown below:

NO.	Parameter Item	Display	Range
1	Transpose	Transpose	-12~+12
2	VOICE R1 Octave	OctaveR1	-1~+1
3	VOICE R2 Octave	OctaveR2	-1~+1
4	VOICE L Octave	Octave L	-1~+1
5	Touch Response	Touch	Hard 2, Hard 1, Normal, Soft 1, Soft 2, Flat
6	VOICE R1 Volume	Volume R1	0~32
7	VOICE R2 Volume	Volume R2	0~32
8	VOICE L Volume	Volume L	0~32
9	MUSIC Volume	Volume Music	0~32
10	Time Signature	Metronome	2/2, 0/4, 2/4, 3/4, 4/4, 5/4, 6/4, 7/4, 8/4, 9/4, 3/8, 6/8, 9/8, 12/8
11	Speaker EQ	Speaker EQ	Piano, Classical Jazz, Pop, Rock, R&B
12	String Resonance	String Res.	0~32
13	Reverb Type	Reverb Type	Room 1, Room 2, Room 3, Hall 1, Hall 2, Hall 3, Hall 4, Church, My Garage, Piano Hall
14	Reverb Level	Reverb Level	0~32
15	Chorus Type	Chorus Type	Chorus 1, Chorus 2, Chorus 3, Chorus 4, GM Cho.1, GM Cho.2, Celeste 1, Celete 2, Symphonic 1, Symphonic 2, Delay 1, Delay 2
16	Chorus Level	Chorus Level	0~32
17	Mic FX Type	Mic FX Type	Echo, Pan, Stereo, Doubler, Distortion, Lo-Fi, Enhancer, Pitch Up, Pitch Down
18	Mic FX Level	Mic FX Level	0~32
19	Song Loop	Song Loop	Single, All, Off

Play Different Keys at the Same Position

The transpose function allows the overall pitch of the piano to be shifted up or down by a maximum of one octave in semitone increments.

1. Select the "Transpose" item.
2. Use the data dial to set transpose parameter value, which changes in semitone.
For example, set transpose parameter value as "+1", you will hear "C#" pitch when playing the "C" key.

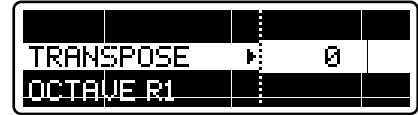

Shift the Pitch of Keyboard by Octave

The Octave function can shift the pitch of a specified voice layer up or down by octave.

1. Select the "Octave R1"/ "Octave R2"/ "Octave L" item.
2. Use the data dial to set octave parameter value, which changes in octave.
For example, set octave parameter value as "+1", you will hear "C4" pitch when play the original "C3" pitch.



Note:

To different preset voices, they have its default octave settings.

Set the Touch Sensitivity of the Keyboard

In order to simulate the acoustic piano touch sensitivity, we have preprogrammed several touch response curves. You can choose the most suitable one for your playing.

1. Select the "Touch" item.
2. Use the data dial to select "Touch Response" type.
You can play the keyboard and try which is the best for you.

Note:

The touch response setting will be automatically saved when you press the power button to power off the piano.



Set the Balance of Voice Layers and Music Volume

You can individually set the volume of Voice R1, Voice R2, Voice R3 and the background music. The background music includes the SONG, MP3 and MIDI files from a USB flash drive, and the USB audio input.

1. Select the "Volume R1", "Volume R2", "Volume L" or "Volume Music" item.
2. Use the data dial to adjust volume level, "0" stands for mute, "32" for the maximum level.

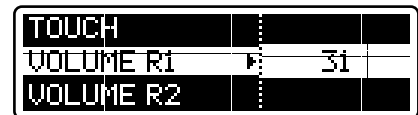

Function Menu

Set the Time Signature for the Metronome

1. Select the "Metronome" item.
2. Use the data dial to set the time signature type.

Note:

If the time signature of a preset song or a MIDI file is different from your setting, the Metronome will work according to the selected or played song.

VOLUME SONG	3/4
METRONOME	4/4
SPEAKER EQ	5/4

Select Different Speaker EQ

According to your favor of the speaker effect, you can select different speaker EQ settings. The selected speaker EQ setting only takes effect on the speakers of the piano; it will not affect the headphones, AUX OUT, USB Audio output or recording.

1. Select the "Speaker EQ" item.
2. Use the data dial to select different speaker EQ settings, you can play back MP3 files at the same time and preview changes.

Note:

The Speaker EQ setting will be automatically saved when you press the power button to power off the piano.

METRONOME	
SPEAKER EQ	Piano
STRING RES.	Classical

String Resonance

When a piano voice is selected, pressing the sustain pedal will activate the String Resonance effect to the notes you played. The String Resonance effect faithfully recreates the resonance from the strings and soundboard of an acoustic grand piano.

1. Select the "String Resonance" item.
2. Use the data dial to adjust the string resonance level.

Note:

The String Resonance setting will be automatically saved when you press the power button to power off the piano.

SPEAKER EQ	
STRING RES.	19
REVERB TYPE	

Add Reverb Effect to Your Performance

The reverb effect creates a realistic environment for your performance, like playing in a concert hall or live in a club.

1. Select the "Reverb Type" item.
2. Use the data dial to select different reverb type, you can play the keyboard at any time to preview changes.

You can also further adjust the reverb level:

1. Select the "Reverb Level" item.
2. Use the data dial to select a suitable reverb level.

Note:

The Reverb Type and Level settings will be automatically saved when you press the power button to power off the piano.

STRING RES.	Hall 2
REVERB TYPE	Hall 3
REVERB LEVEL	Hall 4

REVERB TYPE	
REVERB LEVEL	6
CHORUS TYPE	

Add Chorus Effect to Your Performance

The chorus effect creates a rich ensemble sound, as if one keyboard part was played by several instruments at the same time.

1. Select the "Chorus Type" item.
2. Use the data dial to select different chorus type, you can play the keyboard at any time to preview changes.

You can also further adjust the harmony level:

1. Select the "Chorus Level" item.
2. Use the data dial to select a suitable chorus level.

Note:

The Chorus Type and Level settings will be automatically saved when you press the power button to power off the piano.

Add Vocal Effect to Microphone

Connect a microphone through MIC/AUX IN terminal, switch the MIC/AUX IN to "MIC". Now you can enjoy singing your favorite song! If you want to add some rich and cool effects to your voice, try the Mic FX settings.

1. Select the "Mic FX Type" item.
2. Use the data dial to select different effect type.

You can also further adjust the microphone FX level:

1. Select the "Mic FX Level" item.
2. Use the data dial to select a suitable FX level.

Note:

The Microphone FX Type and Level settings will be automatically saved when you press the power button to power off the piano.

Select the Song Loop mode for Song Playback

You can choose how to loop the songs when playing back internal songs or songs from a USB flash drive.

1. Select the "Song Loop" item.
2. Use the data dial to switch between "Single"-loop single selected song or "All"-loop all internal songs or all songs in the root directory of the USB flash drive.

Note:

The Song Loop setting will be automatically saved when you press the power button to power off the piano.

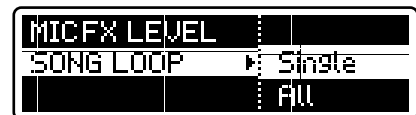
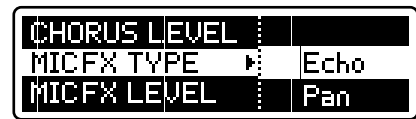
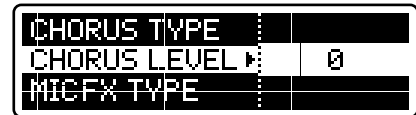
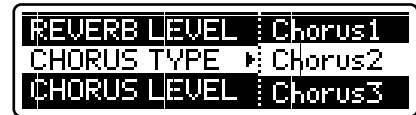

Function Menu

Other Settings

Some global parameters can be found in the Other Settings menu. You can configure these settings as below if necessary.

1. Enter the "Other Settings" menu.
In the VOICE interface, press and hold the [FUNCTION] button about 2 seconds to open the "Other Settings" menu.
2. Select a parameter item.
Repeatedly press the [FUNCTION] button to select a desired parameter item. Or you can use the data dial when keep holding the [FUNCTION] button pressed to quickly select a parameter item.
3. Change parameter value.
Use the data dial to change the selected parameter value.

Detailed parameter items and their value range are shown below:

NO.	Parameter Item	Display	Range
1	MIDI OUT CHANNEL	MIDI OUT CH	1~16
2	AUTO POWER OFF	Power OFF	Never 30min 1 hour
3	SYSTEM DATE--YEAR	Year	2015~2100
4	SYSTEM DATE--MONTH	Month	Jan.-Dec.
5	SYSTEM DATE--DAY	Day	1~31
6	SYSTEM TIME--HOUR	Hour	0~23
7	SYSTEM TIME--MINUTE	Minute	0~59
8	SYSTEM RESET	System Reset	No, Execute

Set MIDI OUT Channel

You may need to change the MIDI OUT channel of VOICE R1 to match your application.

1. Select the "MIDI OUT CH" item.
2. Use the data dial to set the MIDI OUT channel of VOICE R1.

Note:

The MIDI OUT channel setting will be automatically saved when you press the power button to power off the piano.

Set the Auto Power Off Time

In order to save energy, we have designed the Auto Power Off function in this piano. When this function is enabled, the piano will be automatically powered off in 30 minutes (default time) if you do not take any operation on the piano, like playing the keyboard, using the microphone or recording. You can set the time period to decide the auto power off time.

1. Select the "Power OFF" item.
2. Use the data dial to set the Auto Power Off time.
When the Auto Power Off time is set to "Never", the piano will not automatically power off.

Note:

The Auto Power Off setting will be automatically saved when you press the power button to power off the piano.

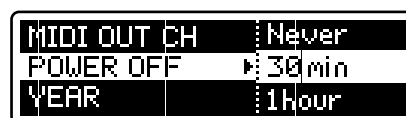
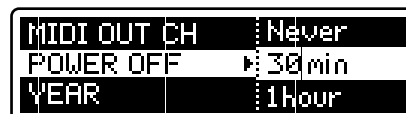
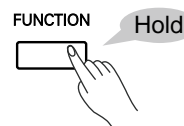

Set the System Date and Time

You may need to set the correct system date and time, as it may be applied to the files saved to USB flash drive and some other functions.

1. You can select the "Year", "Month", "Day", "Hour", or "Minute" item as necessary.
2. Use the data dial to select the date and time parameters.

Note:

The System Data and Time settings will be automatically saved when you press the power button to power off the piano.

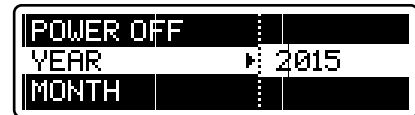

Reset to System Preset

Refer to the following procedures to restore the factory settings:

1. Select the "System Reset" item.
2. Use the data dial to select "Execute".

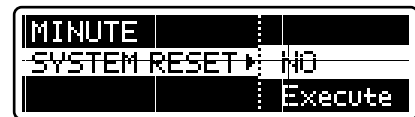

3. The LCD displays "Reset all settings?" for you to confirm. Press the [RIGHT] button to confirm "YES", or press the [LEFT] button to select "NO".

Caution:

If you select "YES", all personal settings will be erased and cannot be recovered.

4. The LCD continually displays "Delete User song?" for you to confirm. Press the [RIGHT] button to confirm "YES", or press the [LEFT] button to select "NO".

Caution:

If you select "YES", the user song will be deleted and cannot be recovered.

5. If you choose to reset the settings or the user song, it will take a period of time to reset the data. Please wait with patience.

Caution:

DO NOT disconnect the power of the piano when the reset operation is in progress! Or internal data could be damaged and your piano may not work!

6. When above steps are finished, the settings and user song of your piano is reset according to your selection.

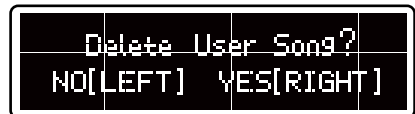
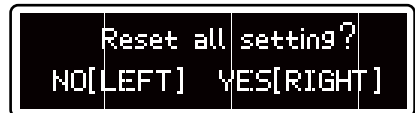
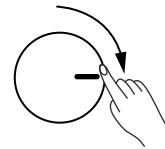

Work with Computer or Smart Device

Your piano is a powerful instrument with USB digital audio as well as USB MIDI IN/OUT.

With this exciting new feature, now you can use the digital music coming from a computer or your smart phone as accompaniment, or use your piano as an excellent USB speaker. What's more, you can even use your smart device or laptop to record lossless digital audio of your performance and share with your friend.

Connect with a Computer

1. Use a USB type A to B cable; connect your piano to a computer through the [USB TO HOST] terminal.
2. The computer will automatically identify your piano and install driver automatically.
After the driver is successfully installed, you may need to manually select your piano as the audio and MIDI IN/OUT devices of your computer.
3. Try playing some music from your computer, your piano is an excellent speaker system.
You can also record the sound from the piano to your computer with audio recorder software.
The audio is transmitted in lossless digital signal.
4. Working with MIDI sequencer software, your piano works as a MIDI sound module or a MIDI keyboard for your creation.

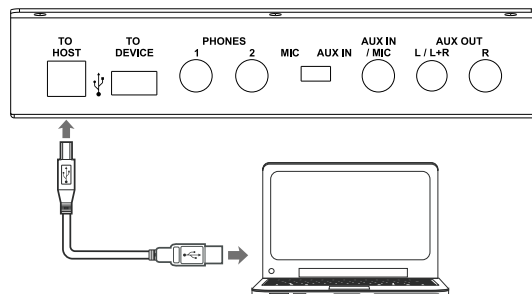

Host Requirements:

- WINDOWS XP SP3 or later WINDOWS operating system.
- OSX 10.8 or later OSX operating system.

Connect with a Smart Device

1. Use an appropriate USB data cable to connect your piano's [USB TO HOST] terminal to a smart device, such as a smart phone or a tablet computer.
2. Try playing back music on your smart device, your piano has an excellent speaker system.
You can also record video as well as audio, the sound track will be recorded directly from the the piano without any noise from the surroundings.
The audio is transmitted in lossless digital signal.
3. Working with a MIDI sequencer APP, your piano can be used as a MIDI sound module or a MIDI keyboard for your creation.

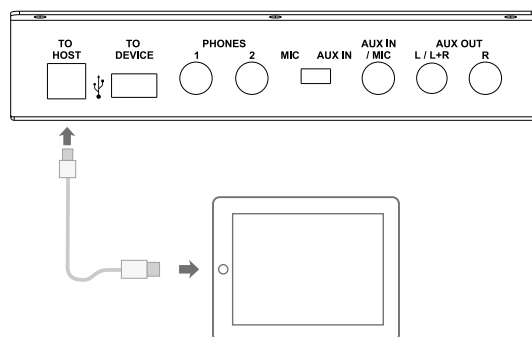

Host Requirements:

- Android 4.0 or later. Some Android devices don't have necessary driver, they may not be able to work with your piano.
- iOS6.0 or later. Connection with iOS device requires apple camera connection kit.

Troubleshooting

The speakers produce a slight pop sound when the power is turned ON or OFF.	This is normal and will not cause any damage to the instrument.
No sound when the keyboard is played.	The R1/R2/L voice volume (Mixer) settings could be set too low. Make sure the voice volumes are set at appropriate levels.
When using a mobile phone, noise is produced.	Using a mobile phone in close proximity to the instrument may produce interference. To prevent this, turn off the mobile phone or keep it away from the instrument when using.
Certain notes sound at wrong pitch.	Make sure that the transpose or octave is set to "0".

Specifications

LCD Display

2.08" Dot-matrix OLED

Keys

88 Graded Hammer-Action Keys with triple switches

Polyphony

256

Preset Voices

40 panel voices

128GM voices

8 GM drum kits

Preset Songs

90 classical songs

Voice Demos

40

Effect

Reverb: 10 types

Chorus: 12 types

Microphone effect: 9 types

Control button

Power Switch, Metronome, Record, Left, Right, Song, USB, Start/Stop, Voice, Voice Demo, Dual, Split, Twinova, Function, Piano

Other Controls

Master Volume Knob, Mic Volume Knob, Brilliance Knob, Tempo Knob with button

Record

SMF 1 MIDI

44.1KHz 16bit Stereo 320Kbps CBR MPEG-1 layer 3 audio

USB to Device

Mass Storage Class USB flash drive, 2GB~128GB, FAT 32

Support SMF 0 and 1 MIDI file, MPEG-1 layer 3 audio file

USB to Host

USB MIDI and USB Audio

Connectors

USB to HOST, USB to DEVICE, 2 Headphones,

AUX IN / MIC, AUX OUT, Pedals (Sustain, Soft, Sostenuto)

Power Supply

DC 15V

Speakers

Woofer: 30W x 2

Tweeter: 25W x 2

Dimensions

1368x517x835mm

Weight

52 kg

* All specifications and appearances are subject to change without notice.

Voice List

No.	Voice Name
1	Grand Piano
2	Grand Piano/Wide
3	Bright Piano
4	Electric Grand
5	Honky Tonk
6	Harpsichord
7	E.Piano 1
8	E.Piano 2
9	Clavi
10	Drawbar Organ
11	Percussive Organ
12	Rock Organ
13	Church Organ
14	Reed Organ
15	Accordion
16	Tango Accordion
17	Guitar & Bass 1
18	Guitar & Bass 2
19	Bass & Vibra
20	Violin
21	Cello
22	Orchestral Harp
23	String Ensembles 1
24	String Ensembles 2
25	Choir Aahs
26	Trumpet
27	Trombone
28	Tuba
29	French Horn
30	Soprano Sax
31	Alto Sax
32	Tenor Sax
33	Baritone Sax
34	Flute
35	Pan Flute
36	Sitar
37	Banjo
38	Shamisen
39	Koto
40	Bag Pipe

Song List

No.	Song Name
1	The entertainer
2	Rialto Ripples (Rag)
3	Neapolitan Song
4	Waltzes
5	Turkish March
6	Schos Doll's Dance No. 2
7	Minuet In D Major
8	Inquietude
9	Italian Polka
10	Moment Musical
11	Prelude In C-Sharp Major
12	The Happy Farmer
13	The Rag-Time Dance
14	Piano Sonata In C Major, K.330. III
15	Mazurka
16	Prelude In E Major
17	Piano Sonata In A Major, K.331. I
18	Waltz For Piano In G-Sharp Minor
19	Gavotte
20	L' Arabesque
21	Austria Variation
22	Schos Doll's Dance No. 7
23	To A Wild Rose
24	Gavotte I
25	Waltz
26	Minuet In G Major (BWV Anh. 116)
27	Innocence
28	Tchaikovsky Waltz
29	Salut d' Amour
30	Barcarolle
31	Robot Doll
32	Consolation
33	2-Part Invention #13 In A Minor.B.W. Iii
34	Minuet In G Major (BWV Anh. 114)
35	Barcarolle
36	Norwegian Dance No.2
37	Moseta Dance
38	The Small Gathering
39	The Return
40	The Wagtail
41	Bulie Dance
42	Tender Blossom
43	Grace
44	Cherish The Memories
45	Chopsticks

No.	Song Name
46	Four Little Swans
47	Progress
48	Eclogue
49	The Limpid Stream
50	Brave Cavalier
51	The Chatterbox
52	Tarantella
53	Frankness
54	Tender Grieving
55	The Farewell
56	The Chase
57	Habanera
58	Prelude In C Major
59	Piano Sonata In C Major, K.545.
60	Piano Sonate op.49-2
61	serenade
62	Prelude D-Dur/D major BWV936
63	Prelude C-Dur/C major BWV924
64	Toys Ragtime
65	Maple leaves Ragtime
66	Chicken pecking Ragtime
67	Pretty girl Ragtime
68	Menuett G dur 3
69	Perpetuum mobile
70	The Nightingale was singing
71	Gipsy Rondo
72	Fountain
73	Fur Elise
74	Prelude F-Dur/F major BWV927
75	Prelude d-Moll/D minor BWV935
76	Prelude e-Moll/E minor BWV938
77	Prelude G-Dur/G major BWV936
78	Dove
79	Knight
80	Ave Maria
81	Prelude G-Dur/G major BWV902a
82	Menuett G dur 4
83	The two part inventions 1
84	The two part inventions 2
85	Gavotte
86	The angels singing
87	Minuet
88	Lyrical Rondo
89	Swallow
90	Minute Waltz

MIDI Implementation Chart

Function		Transmitted	Recognized	Remarks
Basic	Default	1ch	ALL	
Channel	Changed	1-16ch	1-16ch	
Mode	Default	x	3	
	Messages	x	3	
	Altered	*****	x	
Note	Note	0—127	0—127	
Number	:True voice	*****	0—127	
Velocity	Note on	o 9nH,V=1-127	o 9nH,V=1-127	
	Note off	x (9nH,V=0)	o(9nH,V=0; 8nH,V=0-127)	
After	key's	x	x	
Touch	Ch's	x	x	
Pitch Bend		x	o	
Control	0	o	o	Bank Select
Change	1	x	o	Modulation
	5	x	o	Portamento Time
	6	o	o	Data Entry
	7	o	o	Volume
	10	x	o	Pan
	11	x	o	Expression
	64	o	o	Sustain Pedal
	65	x	o	Portamento ON/OFF
	66	o	o	Sostenuto Pedal
	67	o	o	Soft Pedal
	80	x	x	Reverb Program
	81	x	x	Chorus Program
	91	o	o	Reverb Level
	93	o	o	Chorus Level
	120	x	o	All Sound Off
	121	x	x	Reset All Controllers
	123	o	o	All Notes Off
Program		o	o	
Change	:true	*****	0—127	
System Exclusive		x	o	
System	:SongPosition	x	x	
Common	:Song Select	x	x	
	:Tune	x	x	
System	:Clock	o	x	
Real Time	:Commands	x	x	
Aux	:LOCAL ON/OFF	x	x	
Messages	:Active sense	o	o	
	:Reset	x	o	
Notes:				

- Mode 1: OMNI ON, POLY
- Mode 2: OMNI ON, MONO

- Mode 3: OMNI OFF, POLY
- Mode 4: OMNI OFF, MONO

- o: YES
- x: NO

