

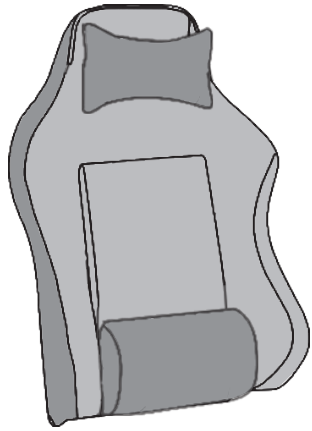

A x1

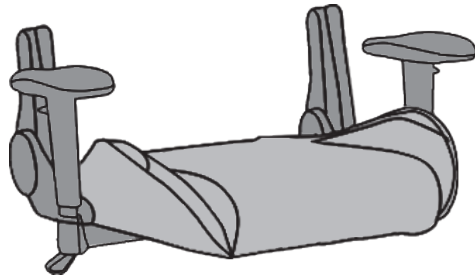

B x1



C x1

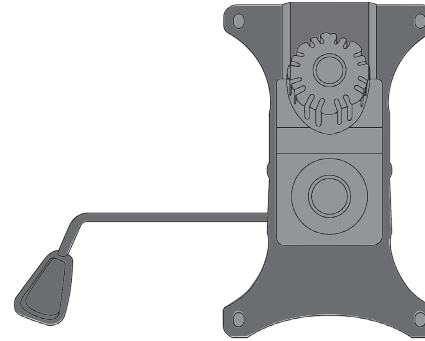

D x1

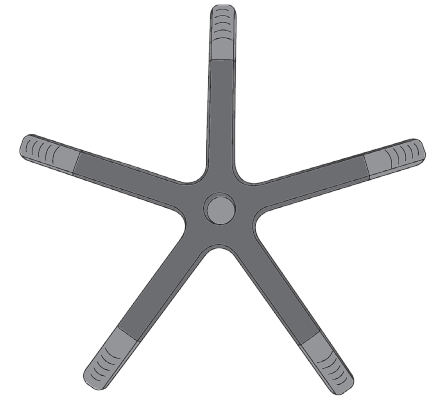

E x5

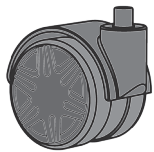

F x1



G

- G-1 X 8
- G-2 X 8
- G-3 X 2

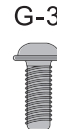
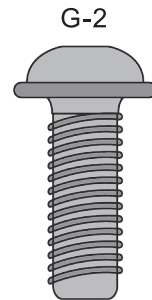
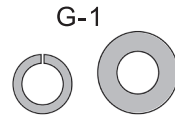

H x1



I x2

