

## WPA Series

### PANELS AND CONTROLS

#### *Wall-mounted Analogue Remote Controls*



## USER MANUAL

# INDEX

<b>1. IMPORTANT REMARK.....</b>	<b>3</b>
<b>2. IMPORTANT SAFETY INSTRUCTIONS .....</b>	<b>3</b>
<b>3. IMPORTANT NOTE.....</b>	<b>5</b>
<b>4. INTRODUCTION.....</b>	<b>5</b>
<b>5. VOLUME CONTROLS / SOURCE SELECTION.....</b>	<b>5</b>
5.1 WPaVOL.....	5
5.2 WPaVOL-J.....	6
5.3 WPaVOL-SR .....	6
5.4 WPaVOL-SR-J.....	7
5.5 Connection tables and diagrams.....	7
<b>6. REMOTE ATTENUATORS .....</b>	<b>8</b>
6.1 WPaH-AT6.....	8
6.2 WPaH-AT100.....	9
6.3 WPaH-SL4.....	10
<b>7. WPaMIX-T.....</b>	<b>11</b>
7.1. Function diagram .....	11
7.2. Configuration diagram.....	12
7.3. Connection terminal block diagram .....	13
<b>8. REMOTE CONNECTORS.....</b>	<b>14</b>
8.1. WPaCNX-CBO .....	14
8.2. WPaCNX-JRCA .....	15
<b>9. TECHNICAL SPECIFICATIONS .....</b>	<b>15</b>
<b>10. MOUNTING DRAWINGS .....</b>	<b>16</b>
WPaVOL, WPaVOL-J, WPaVOL-SR, WPaVOL-SR-J WPaMIX-T WPaCNX-CBO WPaCNX- JRCA.....	16
WPaHAT6, WPa-SL4.....	17
WPaH-AT100.....	18

## 1. IMPORTANT REMARK



WARNING: SHOCK HAZARD - DO NOT OPEN  
AVIS: RISQUE DE CHOC ÉLECTRIQUE - NE PAS OUVRIR



The lightning flash with arrowhead symbol, within an equilateral triangle, is intended to alert the user to the presence of uninsulated “dangerous voltage” within the product’s enclosure that may be of sufficient magnitude to constitute a risk of electric shock to persons.



The exclamation point within an equilateral triangle is intended to alert the user to the presence of important operating and maintenance (servicing) instructions in the literature accompanying the appliance.

**WARNING (If applicable):** The terminals marked with symbol of “” may be of sufficient magnitude to constitute a risk of electric shock. The external wiring connected to the terminals requires installation by an instructed person or the use of ready-made leads or cords.

**WARNING:** To prevent fire or shock hazard, do not expose this equipment to rain or moisture.

**WARNING:** An apparatus with Class I construction shall be connected to a mains socket-outlet with a protective earthing connection.

## 2. IMPORTANT SAFETY INSTRUCTIONS

1. Read these instructions.
2. Keep these instructions.
3. Heed all warnings.
4. Follow all instructions.
5. Do not use this apparatus near water.
6. Clean only with dry cloth.
7. Do not block any ventilation openings. Install in accordance with the manufacturer’s instructions.

8. Do not install near any heat sources such as radiators, heat registers, stoves, or other apparatus (including amplifiers) that produce heat.
9. Do not defeat the safety purpose of the polarized or grounding type plug. A polarized plug has two blades with one wider than the other. A grounding type plug has two blades and a third grounding prong. The wide blade or the third prong are provided for your safety. If the provided plug does not fit into your outlet, consult an electrician for replacement of the obsolete outlet.
10. Protect the power cord from being walked on or pinched particularly at the plugs, convenience receptacles, and at the point where they exit from the apparatus.
11. Only use attachments/accessories specified by the manufacturer.
12. Unplug the apparatus during lightening sorts or when unused for long periods of time.
13. Refer all servicing to qualified personnel. Servicing is required when the apparatus has been damaged in any way, such as power supply cord or plug is damaged, liquid has been spilled or objects have fallen into the apparatus, the apparatus has been exposed to rain or moisture, does not operate normally, or has been dropped.
14. Disconnecting from mains: Switching off the POWER switch all the functions and light indicators of the amplifier will be stopped, but fully disconnecting the device from mains is done unplugging the power cord from the mains input socket. For this reason, it always shall remain readily operable.
15. Equipment is connected to a socket-outlet with earthing connection by means of a power cord.
16. The marking information is located at the bottom of apparatus.
17. The apparatus shall not be exposed to dripping or splashing and that no objects filled with liquids, such as vases, shall be placed on apparatus.

**NOTE:** *This equipment has been tested and found to comply with the limits for a Class A digital device, pursuant to part 15 of the FCC Rules. These limits are designed to provide reasonable protection against harmful interference when the equipment is operated in a commercial environment. This equipment generates, uses, and can radiate radio frequency energy and, if not installed and used in accordance with the instruction manual, may cause harmful interference to radio communications. Operation of this equipment in a residential area is likely to cause harmful interference in which case the user will be required to correct the interference at his own expense.*



**WARNING:** This product must not be discarded, under any circumstance, as unsorted urban waste. Take to the nearest electrical and electronic waste treatment centre.

**NEEC AUDIO BARCELONA, S.L.** accepts no liability for any damage that may be caused to people, animal or objects due to failure to comply with the warnings above.

### 3. IMPORTANT NOTE

Congratulations. You now possess the result of careful design and meticulous manufacturing. We are very grateful for your trust in purchasing our WPa series of Analogue Wall Panel Controls.

In order to obtain maximum effectiveness and performance, it is VERY IMPORTANT, prior to connection, to carefully read and to take into account the instructions given in this manual. To guarantee optimum operation, we recommend that all maintenance be carried out by our authorised Technical Services.

The WPa series comes with a 3-year warranty.

### 4. INTRODUCTION

WPa is a series of wall-mounted remote-control panels for equipment, together with audio signal interconnection. It is a development of its predecessor, the WPm series, with an up-to-date aesthetics, elegant and discrete and designed in collaboration with Italdesign Giugiaro. Surface-mounted installation box is included in the full WPa series.

### 5. VOLUME CONTROLS / SOURCE SELECTION

#### 5.1 WPaVOL

WPaVOL is a wall-mounted remote control for volume management. It is compatible with all devices with 0-10VDC ports.

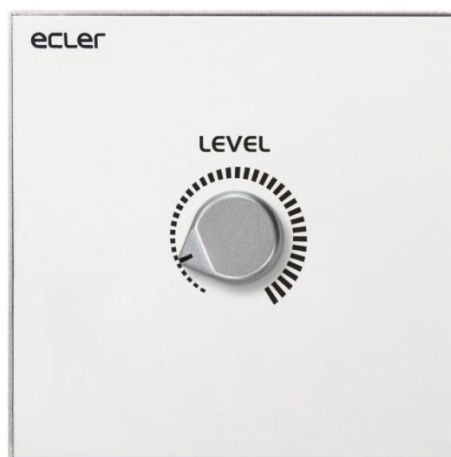

Figure 1: WPaVOL

## 5.2 WPaVOL-J

WPaVOL-J has the same specifications as the WPaVOL, plus a stereo 1/8" jack on the front panel.



Figure 2: WPaVOL-J

## 5.3 WPaVOL-SR

WPaVOL-SR is a wall-mounted remote control for volume management and source/pre-adjust selection. It is compatible with all devices with 0-10VDC ports.



Figure 3: WPaVOL-SR

## 5.4 WPaVOL-SR-J

WPaVOL-SR-J has the same specifications as the WPaVOL-SR, plus a stereo mini-jack on the front panel.



Figure 4: WPaVOL-SR-J

## 5.5 Connection tables and diagrams

RJ-45 Diagram		
Pin 1	White Orange	GND (earth)
Pin 2	Orange	REMOTE VOL (10V-0V → MIN-MAX)
Pin 3	White Green	GND (earth)
Pin 4	Blue	NC
Pin 5	White Blue	NC
Pin 6	Green	VDC (+12V/+10V)
Pin 7	White Brown	GND (earth)
Pin 8	Brown	REMOTE ZONE (0, 3, 5, 7, 10V → OFF, Z1, Z2, Z3, Z4)

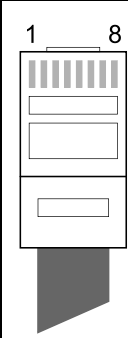

Table 1: RJ-45 connection diagram

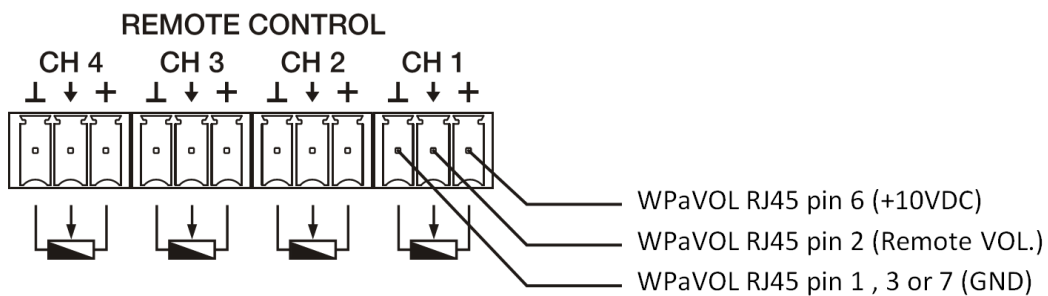

Figure 5: Connection of WPaVOL / WPaVOL-SR to remote-control ports

Terminal Block Diagram (mini-Jack)		
Pin 1	SLEEVE	
Pin 2	RING	
Pin 3	TIP	

Table 2: Mini-jack connection diagram

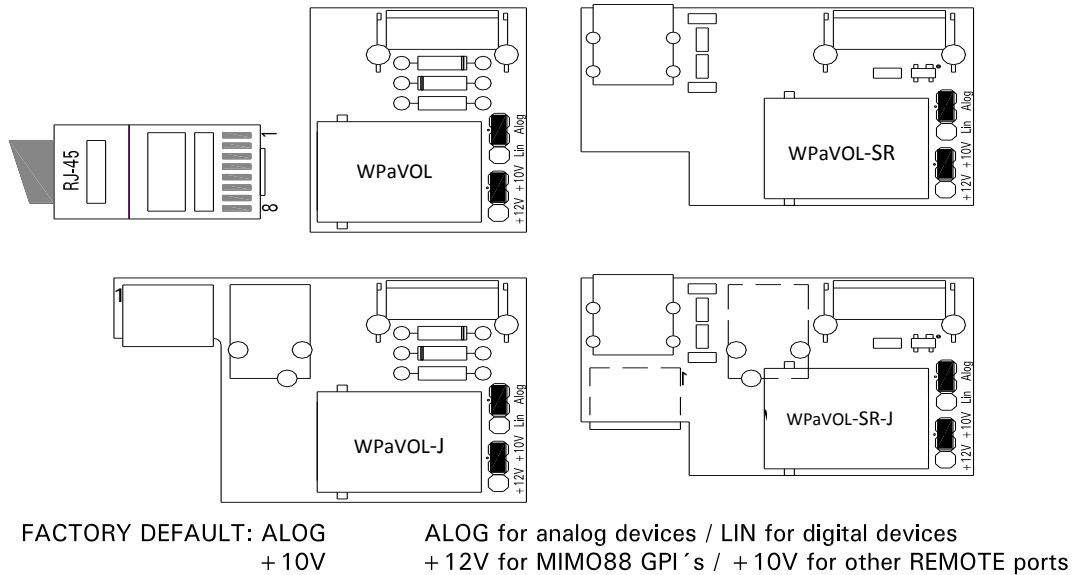

Figure 6: Internal jumpers

## 6. REMOTE ATTENUATORS

### 6.1 WPaH-AT6

The WPaH-AT6 is a 70/100 V line attenuator, with an integrated 24 VDC priority relay. Maximum output power: 6 W



Figure 7: WPaH-AT6  
(see Figure 8 for WPaH-AT6 connection diagram)



## 6.2 WPaH-AT100

The WPaH-AT100 is a 70/100V line attenuator, with an integrated 24 VDC priority relay. Maximum output power: 100 W



Figure 9: WPaH-AT100

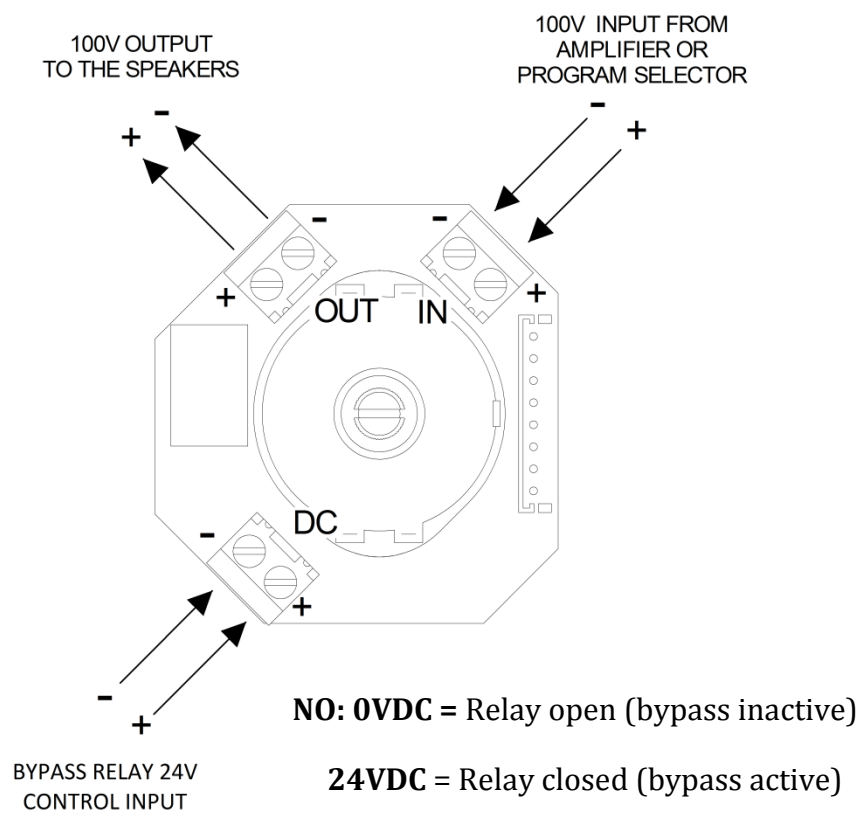

Figure 10: WPaH-AT6 and WPaH-AT100 connection diagram

### 6.3 WPaH-SL4

The WPaH-SL4 is a 70/100V line selector (it selects one of the four music programmes).



Figure 11: WPaH-SL4

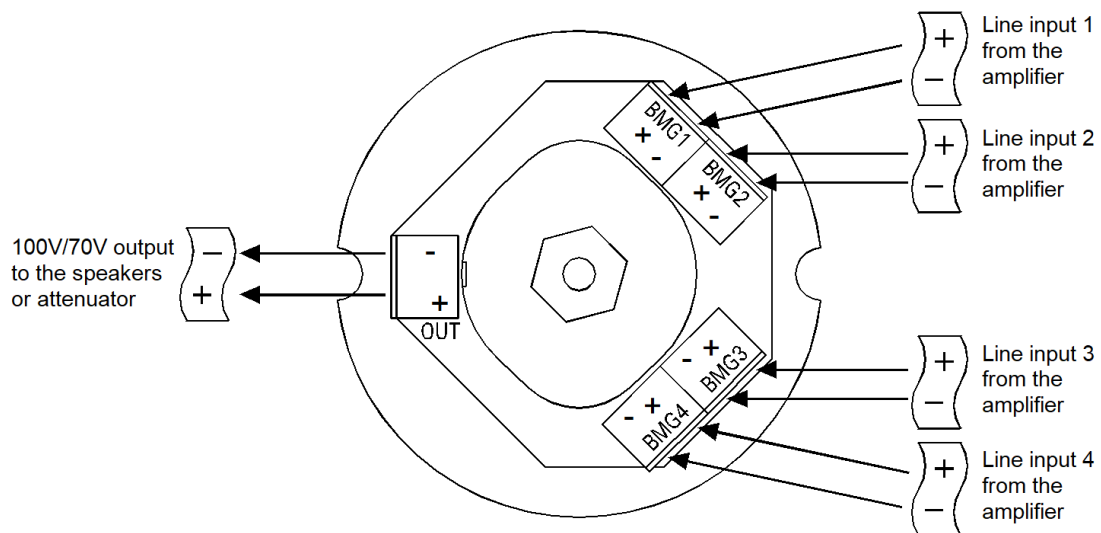

Figure 12: WPaH-SL4 connection diagram

## 7. WPaMIX-T

The WPaMIX-T is a two-channel micro-mixer with the standard WPa series wall panel format. It allows an unbalanced stereo signal (RCA) to be mixed with a microphone signal (XLR) to produce a balanced mono signal output.

The microphone input includes a two-band equaliser (Bass/Treble) and can operate with priority on the line signal when the microphone exceeds the preset detection threshold.



Figure 13: WPaMIX-T

### 7.1. Function diagram

1. Volume control at the microphone input
2. Bass (100 Hz) and treble (10kHz) tone controls at the microphone input ( $\pm 10$  dB).
3. Volume control at the line input
4. XLR connector at the microphone input (balanced signal)
  - Sensitivity: -20 to -40 dBV
5. RCA line input connectors (unbalanced signal)
  - Sensitivity: -10 dBV.

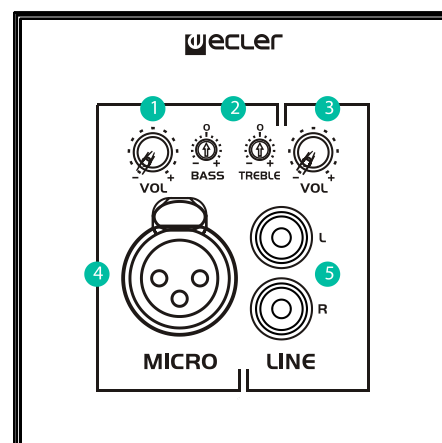

Figure 14: WPaMIX-T functions diagram

The Line and Microphone signals are mixed with relative levels depending on their respective VOL volume controls. This mixing is available at the Euroblock connector output terminals of the unit (unbalanced signal, line level is 0 dBV). Furthermore, the microphone signal may use the Talkover function in order to automatically attenuate the line signal when the microphone signal reaches the Talkover detection threshold (see 06.2 for details of Talkover activation)

## 7.2. Configuration diagram

1. MIC sensitivity selection -20 dBV (jumper removed) or -40 dBV (jumper installed - default position)
2. Talkover function (\*): ON (jumper installed - default position) / OFF (jumper removed).
3. Phantom power supply for the MICRO input: ON (jumper installed) / OFF (jumper removed- default position).

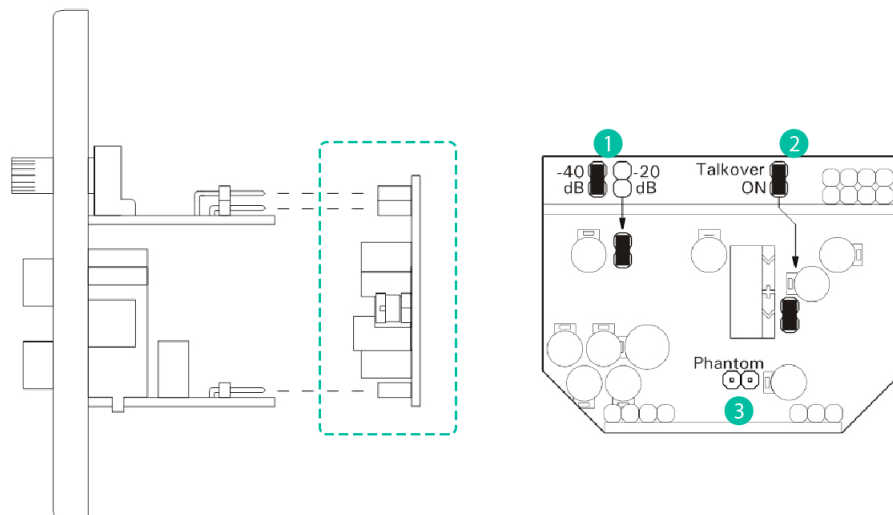

Figure 15: WPaMIX-T configuration

In order to access the configuration jumpers, the circuit must be removed from the rear of the unit by simply pulling on it to unplug it from its connectors and then reinsert it after making the required changes. This operation must be performed with the unit power supply switched off.

(\* ) Talkover attenuation over the line input: 30 dB

Talkover maintenance time three seconds

### 7.3. Connection terminal block diagram

1. Balanced audio output + terminal
2. Balanced audio output earth terminal
3. Balanced audio output - terminal
4. Power supply input - terminal (\*\*)
5. Power supply input + terminal (\*\*)
6. Unused

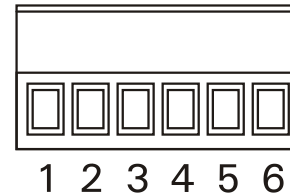

(\*\*) The WPaMIX-T requires an external power supply that can provide 12 to 17 VDC at 430 mA for each WPaMIX-T unit. We suggest using the Ecler WP-PSU, which can power up to twenty WPaMIX-T units (depending on voltage losses caused by cable lengths and sections).

**Recommendation:** Since the WPaMIX-T does not incorporate any electromagnetic shielding, we strongly recommend that it is installed well away from power sources and high-voltage cables.

## 8. REMOTE CONNECTORS

### 8.1. WPaCNX-CBO

WPaCNX-CBO is a wall-mounted remote control, with an XLR female, 3-pin + stereo jack (combo connector) .This connector can be screwed at the rear (does not require any soldering).



Figure 16: WPaCNX-CBO

Terminal Block Diagram (combo connector)		
Pin 1	SLEEVE/GND	
Pin 2	RING/COLD	
Pin 3	TIP/HOT	

Table 3: Combo connector connection

## 8.2. WPaCNX-JRCA

WPaCNX-JRCA is a wall-mounted remote control, with a stereo 1/8" plug connector + two RCA connectors. This connector can be screwed at the rear (does not require any soldering).

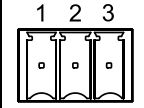
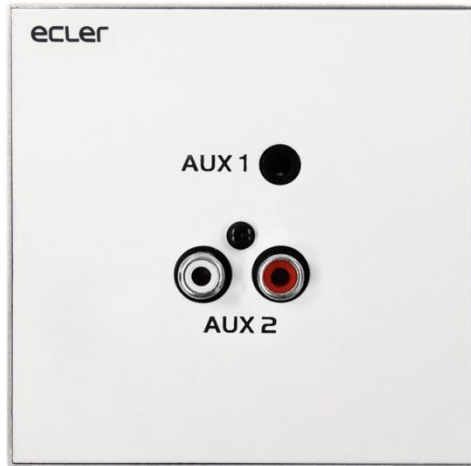

Figure 17: WPaCNX-JRCA

Table 4: Mini-jack connection

Terminal Block Diagram (mini-jack / AUX1)		
Pin 1	SLEEVE	
Pin 2	RING	
Pin 3	TIP	

Table 5: RCA connection

Terminal Block Diagram (RCA / AUX2)		
Pin 1	GND (earth)	
Pin 2	RIGHT CHANNEL	
Pin 3	LEFT CHANNEL	

## 9. TECHNICAL SPECIFICATIONS

<b>Dimensions with surface-mount box (W x D x H)</b>	WPa series: 86 x 38 x 86mm
	WPaH-AT100: 172 x 38 x 86mm

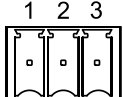
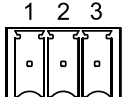
## 10. MOUNTING DRAWINGS

WPaVOL, WPaVOL-J, WPaVOL-SR, WPaVOL-SR-J WPaMIX-T  
 WPaCNX-CBO WPaCNX-JRCA



### ATTENTION

The **C** frame magnets exert considerable force.

The assembly of parts **A** and **B** must be done with caution in order to avoid damaging the **C** frame lining.

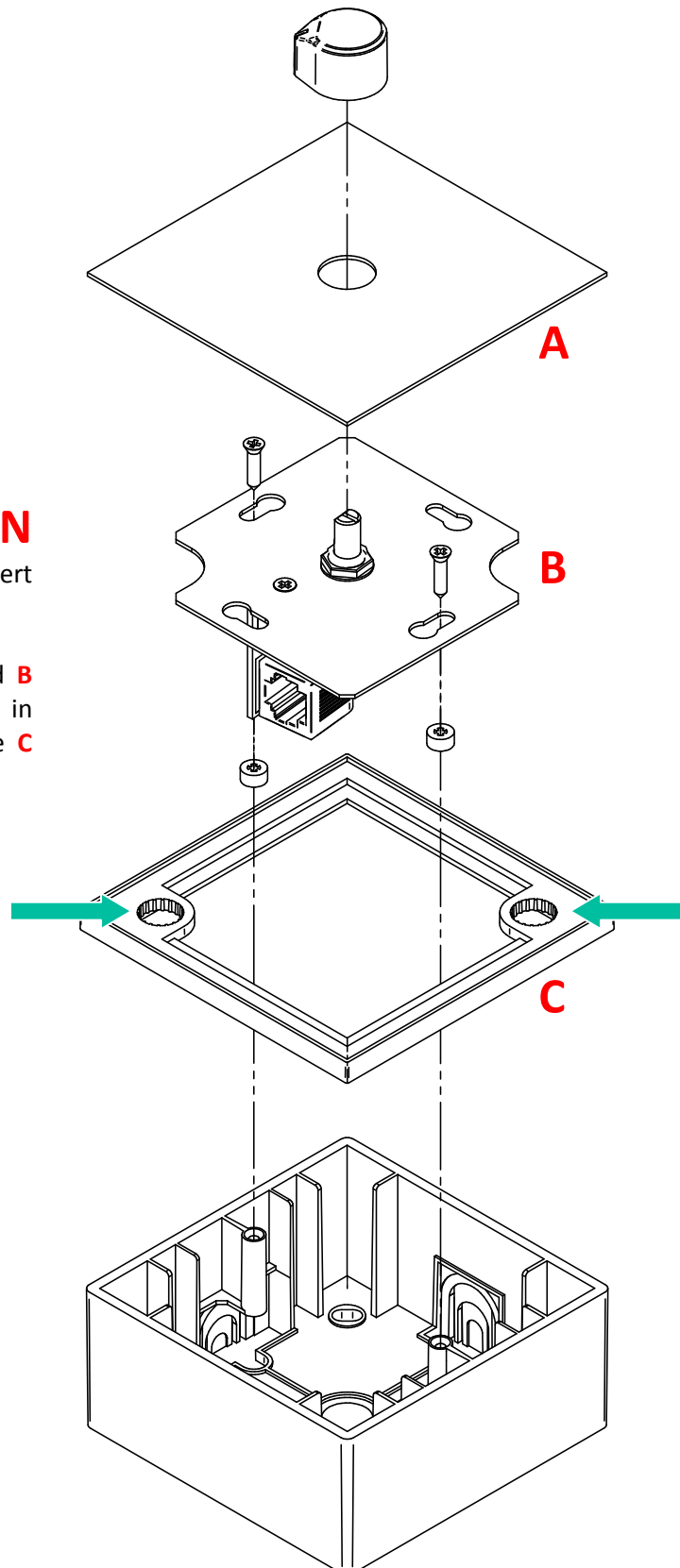



WPaHAT6, WPa-SL4

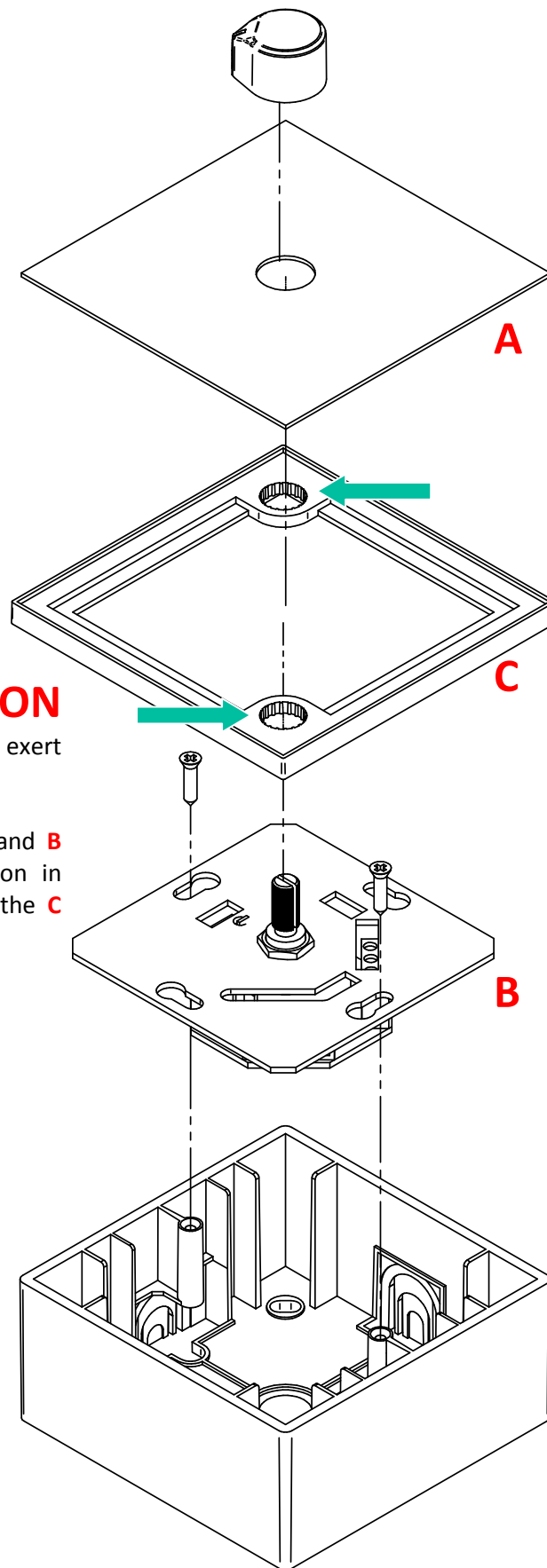

## ATTENTION

The **C** frame magnets exert considerable force.

The assembly of parts **A** and **B** must be done with caution in order to avoid damaging the **C** frame lining.

WPaH-AT100

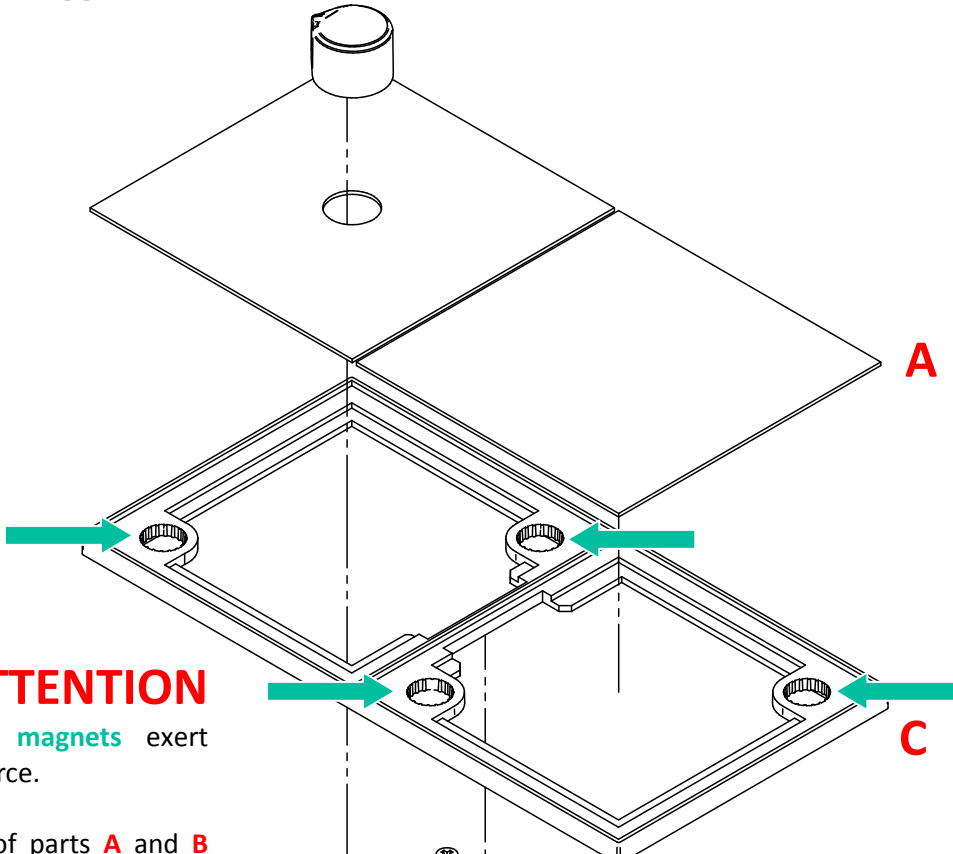

## ATTENTION

The **C** frame magnets exert considerable force.

The assembly of parts **A** and **B** must be done with caution in order to avoid damaging the **C** frame lining.

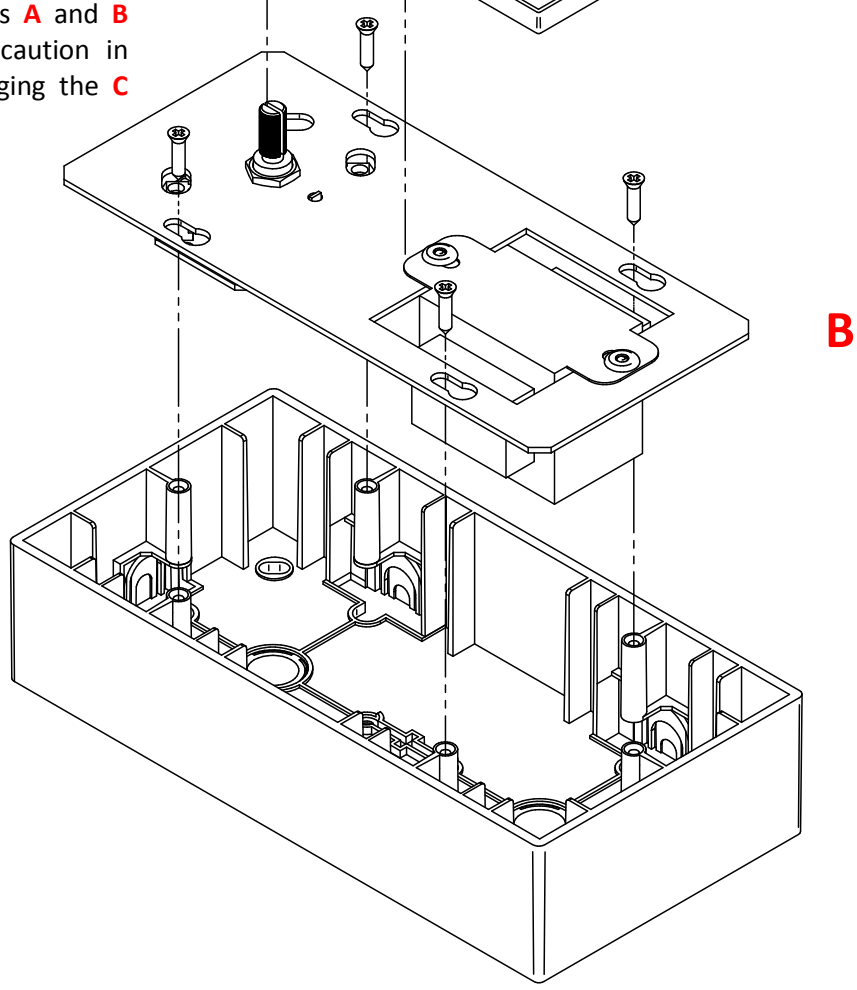

All product characteristics are subject to variation due to production tolerances. **NEEC AUDIO BARCELONA S.L.** reserves the right to make changes or improvements in the design or manufacturing that may affect these product specifications.

Motors, 166-168 08038 Barcelona - Spain - (+34) 932238403 [information@ecler.es](mailto:information@ecler.es) [www.ecler.com](http://www.ecler.com)