

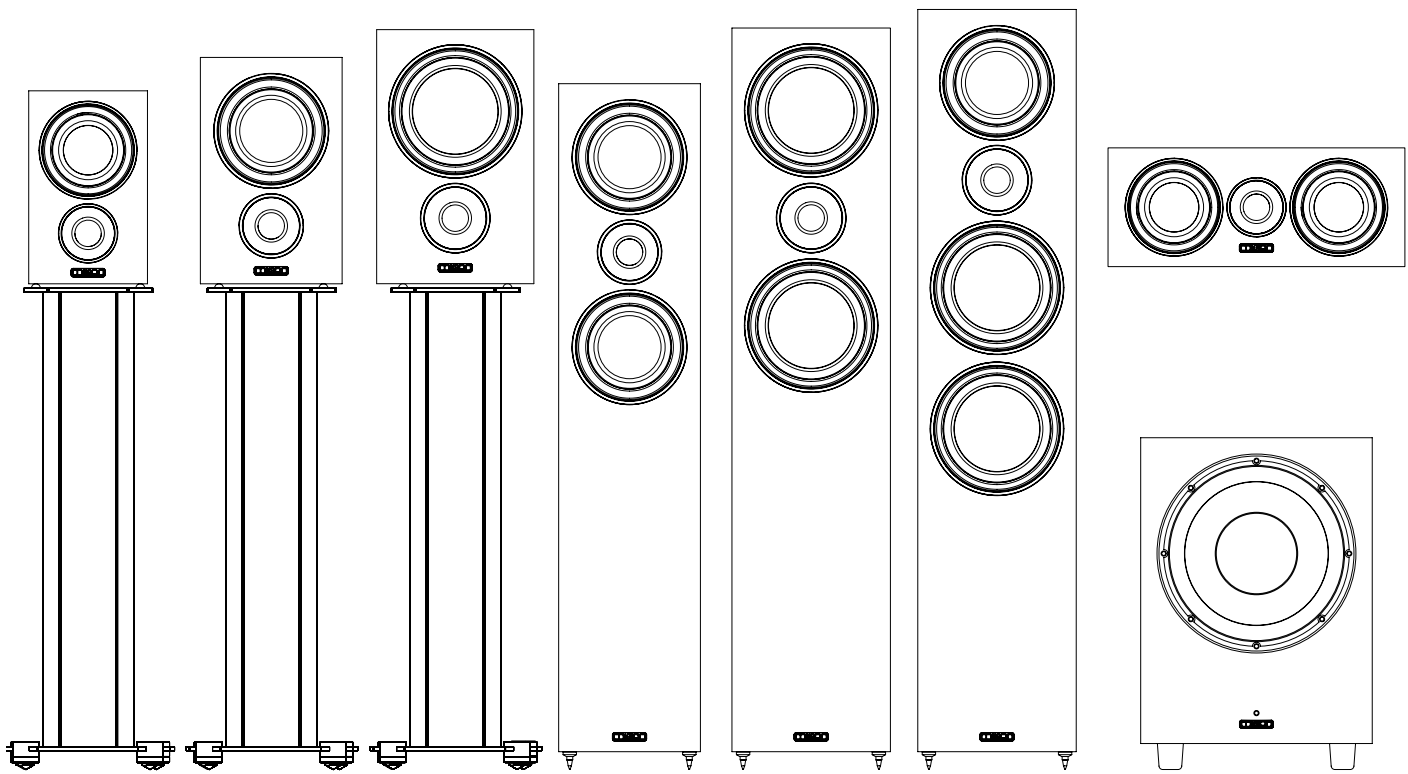

LX-1  
LX-2  
LX-2 +  
LX-3  
LX-4  
LX-5  
LX-C  
LX-10SUB



User's Manual

MISSION



# IMPORTANT SAFETY INSTRUCTIONS



This symbol indicates that there are important operating and maintenance instructions in the literature accompanying this unit.



This symbol indicates that dangerous that dangerous voltage constituting a risk of electric shock is present within this unit.

**WARNING: TO REDUCE THE RISK OF FIRE OR ELECTRIC SHOCK, DO NOT EXPOSE THIS APPARATUS TO RAIN OR MOISTURE.**

Read these instructions.

Keep these instructions.

Heed all warnings.

Follow all instructions.

DO NOT use this apparatus near water.

Clean only with a dry cloth.

DO NOT install near any heat sources such as radiators, heat registers, stoves, or other apparatus (including amplifiers) that produce heat.

Protect the power cord from being walked on or pinched particularly at plugs, convenience receptacles, and the point where they exit from the apparatus.

Unplug this apparatus during lightning storms or when unused for long periods of time.

Refer all servicing to qualified service personnel. Servicing is required when the apparatus has been damaged in any way, such as the power-supply cord or plug is damaged, liquid has been spilled or objects have fallen into the apparatus, the apparatus has been exposed to rain or moisture, does not operate normally, or has been dropped.

Install in accordance with the manufacturer's instructions.

**WARNING:** If using spikes make sure that they do not pierce mains cables etc under / above the carpet.

When making any connections, switch the amplifier off.

When you switch on your system or change sources, set the volume control at minimum and turn the level up gradually.

DO NOT use your amplifier at full volume.

Avoid extreme settings of tone controls or graphic equalisers.

DO NOT place heavy objects on top of loudspeaker cabinets.

Ensure that all loudspeakers in the system are correctly wired and are in phase.

Do not connect your loudspeakers to the mains supply, except for subwoofers.

DO NOT attempt to dismantle the loudspeaker. There are no user serviceable parts inside and you will render the warranty void.

Site hi-fi electronics away from the loudspeakers on a rigid stand or cabinet.

Loudspeakers should not be placed directly facing other hi-fi units, or share the same shelf or cabinet.

Site unscreened speakers and subwoofers at least 0.5m away from TV sets, computers etc. Some manufacturers forbid the placing of objects ontop of their TV sets. Check your TV handbook before installing the centre speaker directly on your TV sets. Consult your TV dealer if you are in any doubt.

Use only attachments / accessories specified by the manufacturer.

DO NOT subject loudspeakers to excessive cold, heat, humidity or sunlight.

DO NOT block any ventilation openings.

DO NOT defeat the safety purpose of the polarized or grounding-type plug. A polarized plug has two blades with one wider than the other. A grounding type plug has two blades and a third grounding prong. The wide blade or the third prong are provided for your safety. If the provided plug does not fit into your outlet, consult an electrician for replacement of the obsolete outlet.

The apparatus must not be exposed to dripping or splashing objects filled with liquids, such as vases, should be placed on the apparatus.



Use only with a card, stand, tripod, bracket or table specified by the manufacturer, or sold with the apparatus. When a card is used, use caution when moving the cart / apparatus combination to avoid injury from tip-over.

**CAUTION:** The mains power switch for electronic equipment should be located in an open area without any obstructions. The mains power plug must remain freely operable at all times.

**CAUTION:** Changes or modifications not expressly approved by the manufacturer could void the user's authority to operate this device.

	<b>CAUTION!</b> RISK OF ELECTRIC SHOCK DO NOT OPEN	
<b>TO REDUCE THE RISK OF ELECTRIC SHOCK DO NOT REMOVE COVER (OR BACK) NO USER-REMOVEABLE PARTS INSIDE REFER SERVICING TO QUALIFIED PERSONNEL</b>		
<b>AVERTISSEMENT: RISQUE DE CHOC ELECTRIQUE- NE PAS OUVRIR</b>		

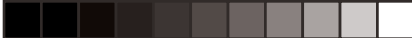

**WARNING:** When an amplifier is driven beyond its power output capabilities it will produce output capabilities it will produce distorted results which will quickly damage your speakers by overheating. Make sure that your amplifier is not left unattended when playing, for example at parties, and turn the volume control down at the first sign of audible distortion,

## Warranty Conditions

The warranty card enclosed should be completed and returned to Mission or its Distributor within 8 days of purchase.

No dealer or distributor may vary the terms of this warranty which is personal to the original purchaser and is not transferable.

Please retain the sales receipt as proof of purchase.

Warranty claims must wherever possible be made through the Dealer from whom the equipment was purchased.

### This warranty excludes:

Damage caused through neglect, accident, misuse, wear and tear, or through incorrect installation, adjustment or repair by unauthorised personnel. Any unauthorised servicing will result in loss of warranty.

Liability for damage or loss occurring in the transit to or from the purchaser.

Consequent damage, loss or injury, arising from or in conjunction with this equipment.

Equipment for attention under warranty should be considered return carriage paid. If equipment is found to comply with the published specification, Mission reserves the right to raise a charge.

The above conditions do not affect your statutory rights as a consumer.



# Welcome to Mission!

The LX Series is the latest in a long line of distinguished Mission loudspeakers. These technologically advanced loudspeakers will complement the finest electronics and décor. This series incorporates purpose – designed bass driver cones, precision engineered motor systems and advanced tweeters. All our loudspeaker drive units are manufactured in our factory using the latest precision tooling. High quality binding posts feature on all models. Your Mission LX speakers will bring you great pleasure for many years.

## General Information

Please read these instructions carefully before installing your loudspeakers. A few minutes studying this manual will ensure a superb performance from your loudspeaker for many years. Please attention to all cautions printed on the pages marked with this symbol



## Preparing Your Loudspeakers

The Mission LX-3, LX-4 and LX-5 floorstanding models require fitting with the included plinth and spikes before use. Use the screw provided to secure the plinths to the base of the speakers. Make sure that the screws are fully tightened.

After unpacking, the other loudspeakers need no further preparation.

Preparing the Floorstanding Loudspeakers (LX-3, LX-4, LX-5)

### Fitting the spikes



**Warning:** Be careful. Loudspeaker spikes are very sharp. When positioning the speakers avoid piercing any electrical cables.

- Invert the loudspeaker and place the top on a soft surface.
- Screw a nut on each spike.
- Screw the spikes into the bushes fitted in the base of the cabinet. Use the sharp end on carpet, or the domed end on hard floors.
- Carefully return the loudspeaker to its normal position.
- Ensure that the spikes do not pierce cables etc. under the carpet.
- Adjust the height by screwing in or out one or more of the spikes until the loudspeaker is stable and level

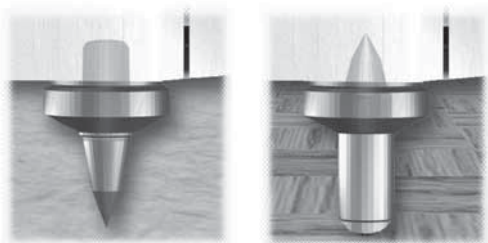

# Connecting your loudspeakers

## Conventional Loudspeaker Connections

Loudspeaker cable is polarity coded along one edge. Split the cable to a depth of about 25mm and strip 8mm of insulation from each wire. If the cable is stranded, twist the strand together.



## Terminal Panels & Connecting The Loudspeakers

Mission LX loudspeakers use a twin terminal connection panel. Only LX-2+ use a four terminal panel which can be bi-wired for improved performance. The HF terminals connect to the treble section of the speaker and the LF terminals to the bass. As supplied, the treble and bass terminal pairs are connected via removable metal straps. These should be removed for bi-wiring installations.

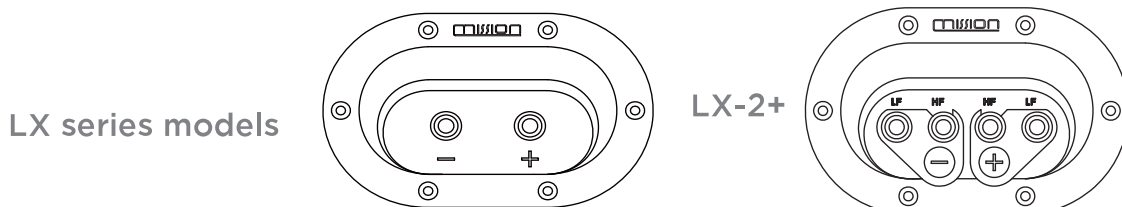

Unscrew the terminal and thread the bare end of the cable through the cross hole ensuring there are no loose strands. Tighten securely.

Connect the red, positive (+) terminal of the left loudspeaker to the corresponding red, positive (+) amplifier terminal. Connect the black, negative (-) terminals similarly. Repeat for all channels accordingly.

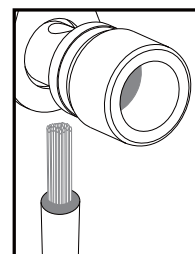

## Positioning Your Loudspeakers

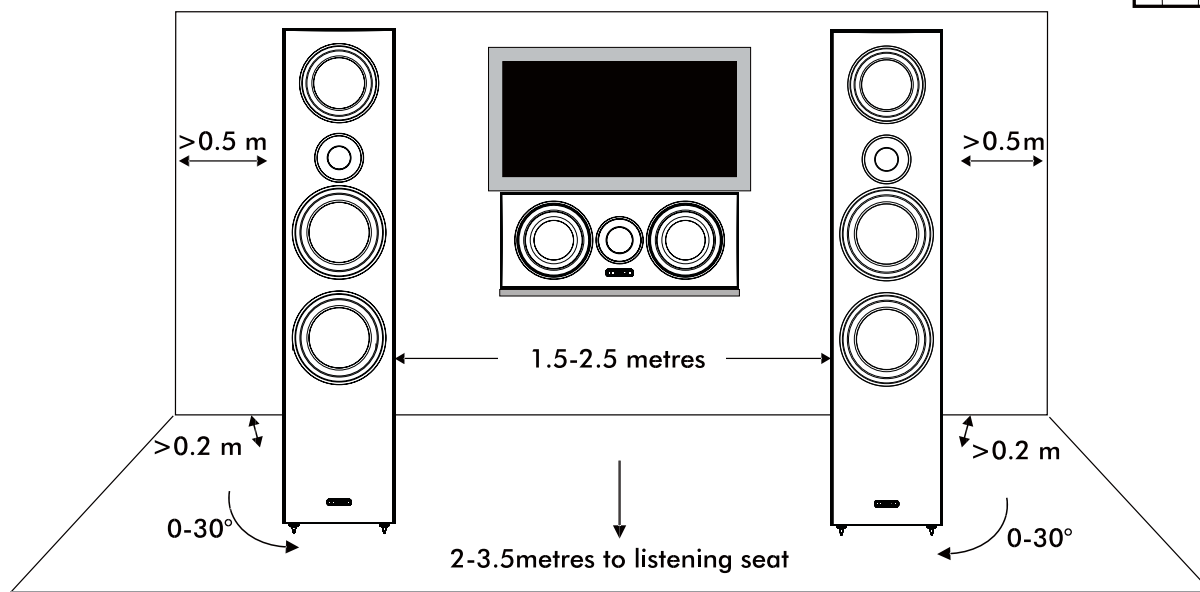

## Floor Standing and Bookshelf Loudspeakers

Mission LX-3, LX-4 and LX-5 loudspeakers should be placed on the floor (ideally on spikes). Mission LX-1 and LX-2 LX-2+ should be mounted on rigid stands, ideally spike coupled to the floor.

Height is important: A stand should place the top of a speaker at ear level to a seated listener. Shelf or bracket mounting is second best. The distance from the wall can profoundly affect loudspeakers' sonic performance. If your speakers are too close to the wall the bass will boom and sound will be coloured. Moving them into the room may increase clarity but tends to reduce the bass output. When positioned correctly, the high frequency response is smooth with well-defined, powerful bass. Start with the speakers about 300mm from the wall and 1.8m apart. The distance from each loudspeaker to the side wall should be at least 500mm. Vary the distance between the two loudspeakers and the distance from the wall until you get a perfect stereo stage. If your loudspeakers are wired correctly, the sound should be full with a clean treble and a deep, rich bass.

## Centre and surround speaker

Your LX-C centre loudspeakers should be positioned ontop of the TV monitor or on a shelf in a console below the TV set. If you place the unit directly on top of the TV, ensure that the cabinet can stand the weight and the assembly is stable. Place the stand on a stable surface and place the LX-C on the stand. Ensure the stand is central to the speaker cabinet. Check your TV handbook or consult your TV dealer if you are in any doubt.

The surround speakers should be placed above head height and behind the listening seat. They may be stand or bracket mounted on the side walls or on the rear walls but always behind the listener. Do not operate them within 450mm of a TV screen.

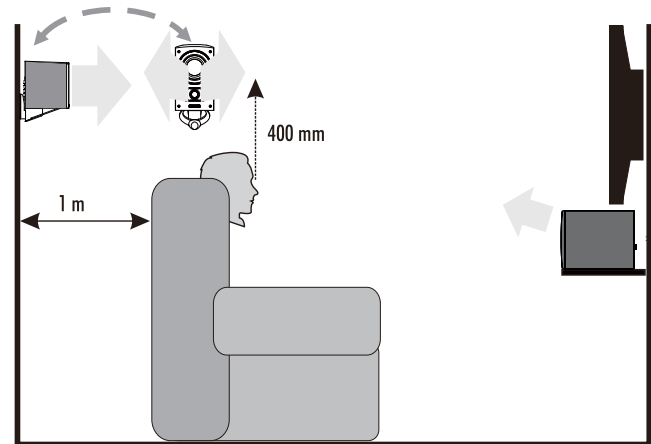

## Tuning and Phase

**Phase:** To check the loudspeaker phase, check the polarity of your speaker wire at the terminals of the loudspeakers and at the loudspeaker terminals of the amplifier. The conductor colour should always be connected the same way round. If your loudspeakers are connected correctly, you will hear a full sound with clean midrange and a deep, powerful bass.

**Fine Tuning:** All the loudspeakers except the LX-C are reflex enclosures. Although these will not normally be needed, foam port bungs are provided which may be used to alter the bass parameters and damp resonances, especially when operating the loudspeakers next to walls etc.

Place a bung in each speaker port and adjust them in and out as needed.

## Tuning and Phase

**Phase:** To check the loudspeaker phase, check the polarity of your speaker wire at the terminals of the loudspeakers and at the loudspeaker terminals of the amplifier. The conductor colour should always be connected the same way round. If your loudspeakers are connected correctly, you will hear a full sound with clean midrange and a deep, powerful bass.

**Fine Tuning:** All the loudspeakers except the LX-C are reflex enclosures. Although these will not normally be needed, foam port bungs are provided which may be used to alter the bass parameters and damp resonances, especially when operating the loudspeakers next to walls etc.

Place a bung in each speaker port and adjust them in and out as needed.

## 5.1 System connections

The front left and front right channels are bi-wired to provide the best fidelity.

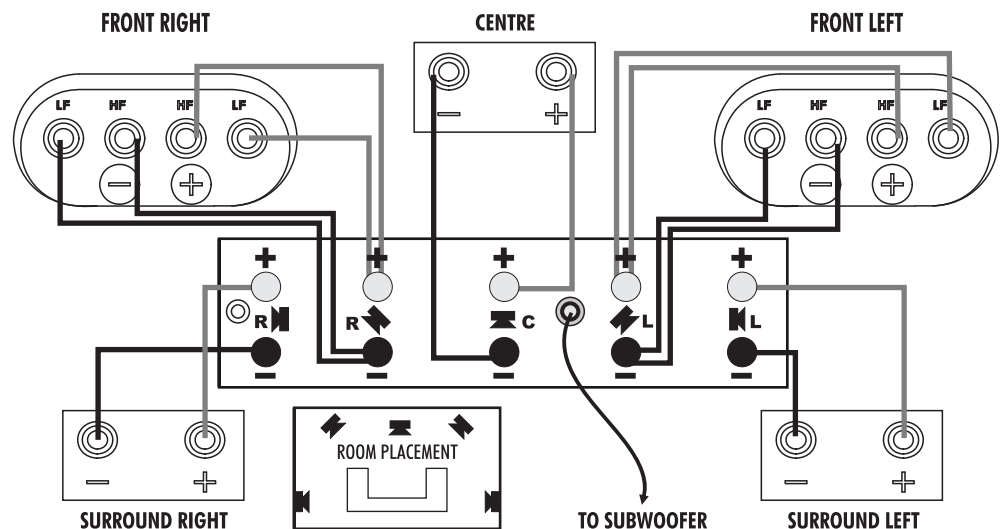

### Setting Speaker Sizes

When used with a subwoofer, digital AV processors usually require you to set the size of the loudspeakers for good bass management. This is usually 'Large' or 'Small'. With the exception of the LX-1 and LX-2, LX-2+ all the loudspeakers should be set to 'Small'. Depending on the performance of your subwoofer you may set the LX-3 to 'Large' or 'Small'.

## Home Theatre Topics

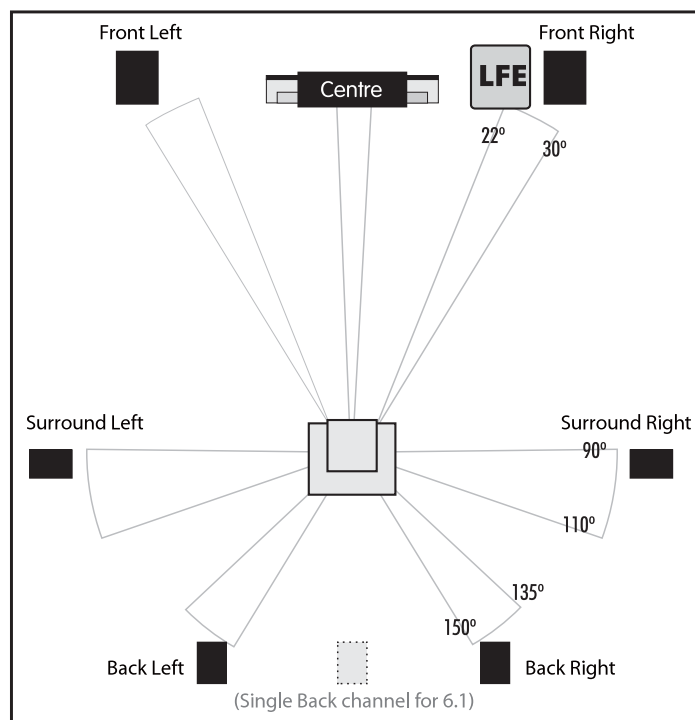

### Loudspeaker Positioning

**Front Loudspeakers:** The front loudspeakers are placed on either side of the TV monitor, 2 to 3 metres apart. The speakers should be angled slightly so they are aimed towards the listeners.

### Rear Surround Channels

We recommend placing the surround speaker in a high position, behind the listeners head. If the rear wall is more than 1 metre behind the listening seat, an alternative position is on the side walls. If the walls are a long way from the listening seat, consider stand mounting the loudspeakers.

### Centre Channel

Most of the dialogue comes from the centre loudspeaker. Speech should appear to originate from the actors mouths. Operating height is important. Ideally the front and centre channel speakers should be at the same height. The front of the cabinet should be level with the TV screen.

## CONNECTING THE SUBWOOFER TO THE SYSTEM

### Control Panel of the LX-10SUB Subwoofer

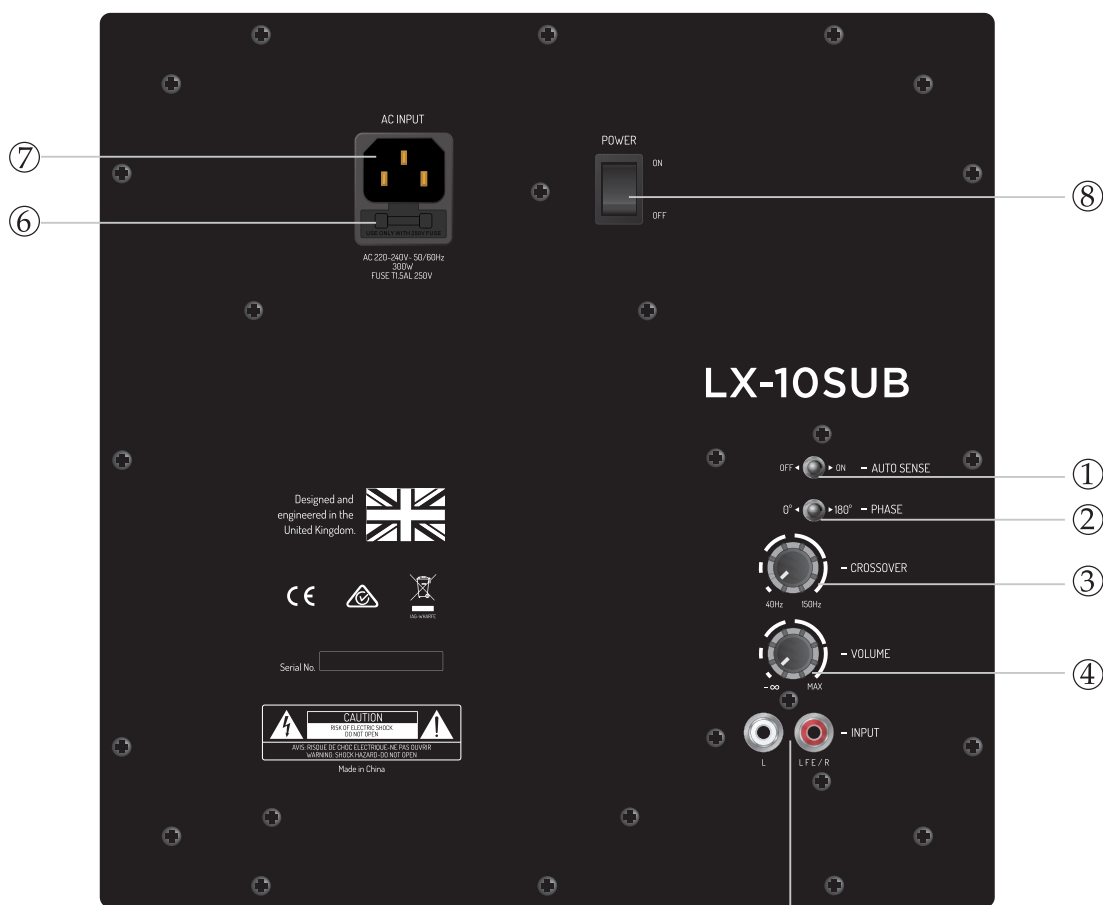

1 Auto Sense Switch

2 Phase Switch

3 Crossover Frequency Control

4 Volume Control

5 Line Level Input/LFE Input

6 Mains Power Fuse

7 IEC Mains Input Socket

8 Mains Power Switch

## A/V Processor Connections

Your subwoofer has been designed for optimum performance with a digital processor. If your A/V processor has a line level or LFE subwoofer output you should use this connection. You will need to purchase a single screened RCA phono lead from your dealer. Connect this lead to the LFE input of the subwoofer as shown.

Alternatively, you may use a split mono lead from the processor to Line Inputs of the subwoofer. In this case the input level at the subwoofer will be slightly higher.

## Stereo Line Output Connections

If your amplifier has a spare preamplifier output or a stereo subwoofer output, connect the subwoofer as shown. You will need a stereo screened RCA phono cable.

## Pre Out - Main in Connections

If you use a stereo pre and power amplifier, or an amplifier where the pre and main amplifier can be separated, connect the subwoofer as shown. There are two alternative methods.

You will need two screened RCA 'Y' adaptors and two single RCA phono cables.

Remove the Pre-Main links on your amplifier. Connect the socket (common) of an RCA 'Y' adaptor to the Left Channel Pre Out socket on the amplifier and the other leg to the Left Channel Main In socket. Connect the remaining plug on this combination to the Left Channel Line Level input on the subwoofer. Repeat this for the Right Channel.

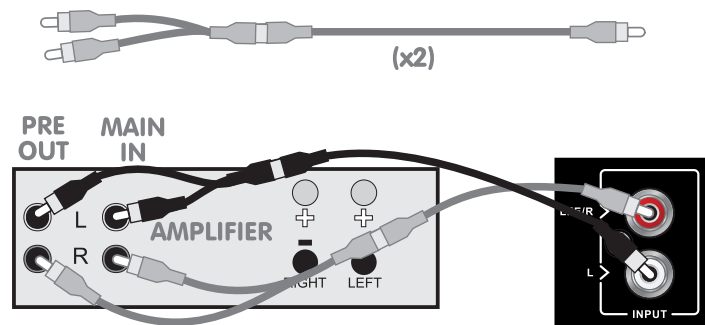
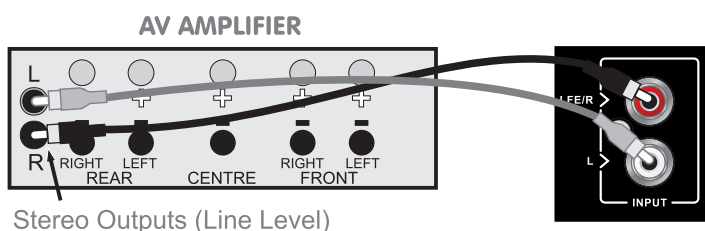
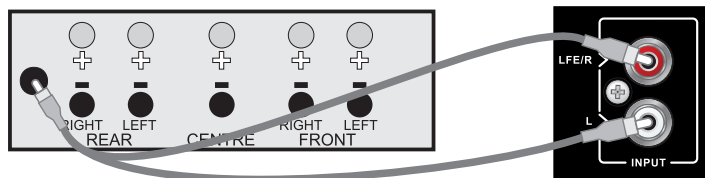
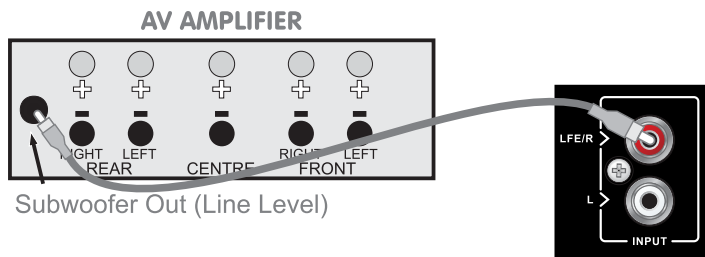

# OPERATING YOUR SUBWOOFER

Check that all connections to the subwoofer have been properly made and that the main volume control is at minimum. Plug the supplied power cord into the mains socket on the rear panel.

## Initial Settings

**Volume Control:** Set the subwoofer volume control to the minimum before proceeding.

**Crossover Control:** Adjust frequency to integrate LX-10SUB subwoofer with your system requirement.

**Phase Switch:** The Phase switch should be initially set to 0°.

## Switching On

Plug in the mains plug and switch the power on. Now switch the subwoofer on with the rest of your system.

When switched on, the power indicator light will glow and the subwoofer will be operational.

## Basic Tuning

**Volume Setting:** Play a programme with extended bass and set the system volume to a resonal level. Adjust the subwoofer volume control to produce the desired level of bass. The bass should be even and an extension of the main loudspeakers. Do not set the control too high or you will swamp the sound with too much bass and clarity and definition will suffer.





## OPERATING YOUR SUBWOOFER

**Phase Switch:** If the bass is indistinct or lacks depth, the Phase switch may need adjustment. Set the switch to 0° and listen carefully to some music with extended bass. If there is insufficient bass output from the subwoofer set the Phase switch to 180°. Select the position which produces the most natural, extended bass.

**Crossover Adjustment:** This adjusts the blend between the subwoofer and the main speakers and enables the system to be set up for optimum bass performance. The higher settings are for use with small bookshelf loudspeakers, the lower setting for large floorstanding models. If you choose too low a setting with small speakers, there will be a 'hole' in the bass response; too high a setting with large speakers will result in the upper bass becoming bloated. Again the subwoofer should be an extension of the main loudspeakers.

**Auto-Sense Switch:** This feature reduces the power consumption when there is no music signal. When the Auto-Sense Switch is on, the amplifier will be activated immediately once an audio signal is detected at the inputs, and it will turn into the mute status when no signal is detected for about 20 minutes, which lowers the power consumption. This feature can be made invalid by setting this switch to off.

### Mains Operation

When the system is not in use for extended periods, we suggest you switch off the subwoofer to protect it from switching noises caused by domestic appliances, etc. The best practice is to switch the complete system on and off from a central point. Bear in mind that if you play the system with the subwoofer switched off you will get no bass!

Always turn the main volume control to minimum when you switch the system on or off.

## Loudspeaker Maintenance

Use a cloth to clean your cabinets and very occasionally, a slightly dampened cloth to remove finger marks etc. Although the grilles may be removed, these speakers have been voiced to sound at their best with the grilles on. We do not advocate removal of the grilles: if necessary clean grilles carefully in place with a soft brush.

## Service Centre

Should a fault occur with your loudspeakers, please pack it correctly, using the original packing, so you can ship it safely. Product for service should be returned to the appointed dealer from whom you purchased the product. If you experience difficulties or there is no mission dealer in your area, contact the Mission distributor or the office below.

### UK

IAG Service Dept, 13/14 Glebe Road, Huntingdon, Cambridgeshire PE29 7DL, UK

Tel: +44 0 1480 452 561

Fax: +44 0 1480 413 403



# Specifications

Model	Mission LX-1	Mission LX-2	Mission LX-2+
General description	Bookshelf	Bookshelf	Bookshelf
Enclosure type	Ported	Ported	Ported
Transducer complement	2-way	2-way	2-way
Midrange driver			
Bass driver	100mm advanced fibre	130mm advanced fibre	165mm advanced fibre
Treble driver	25mm microfibre dome	25mm microfibre dome	25mm silk dome
AV magnetically shielded	No	No	No
Sensitivity (1W @ 1m)	85db	86,5db	88db
Recommended amplifier power	20-80w	20- 100w	20-120w
Nominal impedance	6 Ohms	6 Ohms	6 Ohms
Minimum impedance	4,1 Ohms	4,4 Ohms	3,5 Ohms
Frequency response (+/-3dB)	65-20kHz	60- 30kHz	45-30kHz
Crossover frequency	2.2kHz	2.8kHz	2.0kHz
Cabinet Volume (in litres)	5.5L	8.5L	13,2L
Dimensions (mm)			
Height (on plinth & spikes)	260mm	305mm	345mm
Width	160mm	191mm	214mm
Depth (with grille)	(225+10)mm	(250+10)mm	(300+10)mm
Carton size	450*325*365mm	525*370*415mm	570*410*470mm
Net weight	4.3 kg	6,3kg	8,3kg/pcs
Gross weight	10,1kg/carton	14,4kg/carton	18,6kg/carton
Finish	Black wood /Walnut /White	Black wood /Walnut /White	Black wood /Walnut /White

Model	Mission LX-3	Mission LX-4	Mission LX-5
General description	Floor-standing	Floor-standing	Floor-standing
Enclosure type	Ported	Ported	Ported
Transducer complement	2-way	2-way	3-way
Midrange driver			130mm advanced fibre
Bass driver	2 x 130mm advanced fibre	2*165mm advanced fibre	2*165mm advanced fibre
Treble driver	25mm microfibre dome	25mm microfibre dome	25mm microfibre dome
AV magnetically shielded	No	No	No
Sensitivity (1W @ 1m)	89,5db	90db	90db
Recommended amplifier power	30- 120w	15-150w	15-200w
Nominal impedance	6 Ohms	6 Ohms	6 Ohms
Minimum impedance	3,6 Ohms	3,7 Ohms	3,0 Ohms
Frequency response (+/-3dB)	42-20kHz	40- 30kHz	38-30kHz
Crossover frequency	2.2kHz	2.2kHz	580Hz/ 2.8kHz
Cabinet Volume (in litres)	29L	42L	3,2L&72,5
Dimensions (mm)			
Height (on plinth & spikes)	(900+ 20)mm	(975+20)mm	(1000+ 20)mm
Width	191mm	214mm	214mm
Depth (with grille)	(265+10)mm	(300+10)mm	(325+10)mm
Carton size	410*315*1035mm	435*340*1110mm	460*340*1135mm
Net weight	14,8kg	18 kg	21kg
Gross weight	17kg/carton	20,6 kg/carton	24kg/carton
Finish	Black wood /Walnut /White	Black wood /Walnut /White	Black wood /Walnut /White

# Specification

<b>Model</b>	<b>Mission LX-C</b>
General description	Centre channel
Enclosure type	Closed box
Transducer complement	2-way
Midrange driver	
Bass driver	2*100mm advanced fibre
Treble driver	25mm microfibre dome
AV magnetically shielded	Yes
Sensitivity (1W @ 1m)	87,5db
Recommended amplifier power	20- 100w
Nominal impedance	6 Ohms
Minimum impedance	5,0 Ohms
Frequency response (+/-3dB)	80- 30kHz
Crossover frequency	2.1kHz
Cabinet Volume (in litres)	7.6L
Dimensions (mm)	
Height (on plinth & spikes)	160mm
Width	400mm
Depth (with grille)	(200+10)mm
Carton size	500*315*275mm
Net weight	6.3kg
Gross weight	7.7kg/carton
Finish	Black wood /Walnut /White

## Mission LX-10SUB

<b>Description/Format</b>	<b>Active Dynamic-Drive IB subwoofer system</b>
<b>Drive Units</b>	<b>1 x (10")250mm cone long-throw</b>
<b>Frequency Response</b>	<b>40- 200Hz ±3dB</b>
<b>Amplifier Power Output</b>	<b>200W</b>
<b>Peak Power Output</b>	<b>350W</b>
<b>Line Input Sensitivity</b>	<b>200mv for maximum output</b>
<b>Crossover Range</b>	<b>30 - 150Hz</b>
<b>Inputs</b>	<b>Stereo Line In (2 x RCA Phono)</b>
	<b>Mono (LFE) Line In (RCA Phono)</b>
<b>Input Impedance</b>	<b>Line Input 10kΩ</b>
	<b>LFE 5kΩ</b>
<b>Signal-to-noise ratio (S/N)</b>	<b>≥85dB</b>
<b>Avg. Max Output @1m</b>	<b>110dB</b>
<b>Features</b>	<b>Phase inversion, Auto on-off</b>
<b>Dimensions</b>	<b>Height: (412+35)mm(with feet)</b>
	<b>Width: 312mm</b>
	<b>Depth: (392+15)mm</b>
<b>Net weight</b>	<b>16kg</b>
<b>Gross weight</b>	<b>18,5kg/carton</b>
<b>Finishes</b>	<b>Cabinet: Rosewood /Walnut Pearl/White sandex/Blackwood Vinyl</b>

**Warning:** When an amplifier is driven beyond its power output capabilities it will produce distorted results which will quickly damage your speakers by overheating. Make sure that your amplifier is not left unattended when playing, for example at parties, and turn the volume control down at the first sign of audible distortion. Playing music at extremely high volumes for extended periods can permanently damage your hearing.

Mission reserve the right to alter specifications where necessary - E&OE.



IAG House, 13/14 Glebe Road, Huntingdon, Cambridgeshire, PE29 7DL, UK  
Tel: +44(0)1480 452561 Fax: +44(0)1480 413403 [www.mission.co.uk](http://www.mission.co.uk)  
IAG reserves the right to alter the design and specifications without notice. All rights reserved © IAG Group Ltd.  
Mission is a member of the International Audio Group. CODE: MH14-MNL005a

