

PLUTO 350

USER MANUAL

 [®] PLUTO 350
SS659

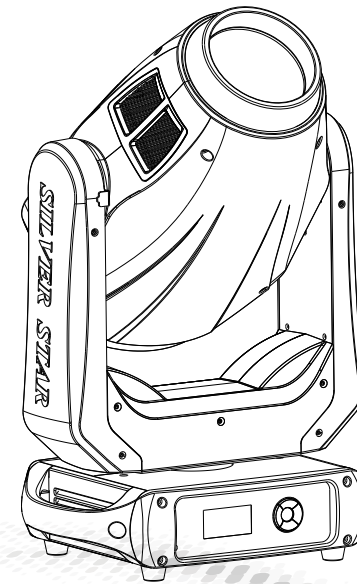

MODEL:SS659SC



广州市雅江光电设备有限公司

Guangzhou Yajiang Photoelectric Equipment Ltd.

电话/Tel : 020-86947788 邮箱/E-mail : sales@yajiang.cn

传真/Fax : 020-86943773 网址/Website : www.yajiang.cn

— Since 1985 —

RD-SS659-SM-00(SS-I)

1 Product specifications

1.1 Technical specifications

LED Module:

- ◆ Voltage: AC100V~240V, 50/60Hz
- ◆ Power: 450W
- ◆ Dimension: 359x249x596mm
- ◆ Weight: 18.5Kg

1.2 Dimensions

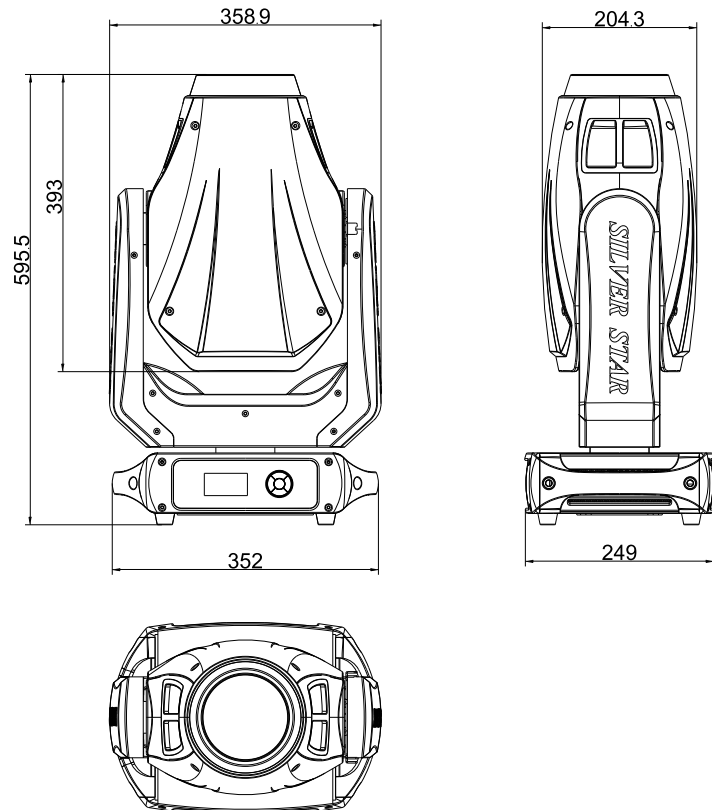

CHANNEL	VALUE	FUNCTION
CH.21	STORBE	
	0 ↔ 9	NO FUNCTION
	10 ↔ 99	STROBE FROM (SLOW TO FAST, 0-25Hz)
	100 ↔ 109	NO FUNCTION
	110 ↔ 179	LIGHTNING STROBE
	180 ↔ 189	NO FUNCTION
	190 ↔ 255	RANDOM STROBE
CH.22	CONTROL	
	000 ↔ 010	NO FUNCTION
	011 ↔ 020	PAN/TILT BLACK ACTIVATED
	021 ↔ 030	PAN/TILT BLACK DEACTIVATED
	031 ↔ 040	PAN INVERT
	041 ↔ 050	TILT INVERT
	051 ↔ 060	PAN/TILT INVERT OFF
	061 ↔ 070	FAN SLOW
	071 ↔ 080	FAN NORMAL
	081 ↔ 090	FAN FAST
	091 ↔ 100	FAN AUTO
	101 ↔ 110	DIM4
	111 ↔ 120	DIM3
	121 ↔ 130	DIM2
	131 ↔ 140	DIM1
	141 ↔ 150	DIM0
	151 ↔ 160	1200Hz
	161 ↔ 170	2400Hz
	171 ↔ 180	4000Hz
	181 ↔ 190	6000Hz
	191 ↔ 200	25000Hz
	201 ↔ 210	ALL RESET
	211 ↔ 220	XY RESET
	221 ↔ 230	COLOR SYSTEM RESET
	231 ↔ 240	GOBO RESET
241 ↔ 250	FOCUS\ZOOM\FROST\PRISM RESET	
251 ↔ 255	NO FUNCTION	

	107 ↔ 114	GOBO7 SHAKE (SPEED 1 → 100%)
	115 ↔ 122	GOBO8 SHAKE (SPEED 1 → 100%)
	123 ↔ 127	WHITE
	128 ↔ 190	ROTATING GOBO FLOWING WATER EFFECT (SPEED 100% → 1)
	191 ↔ 192	STOP
	193 ↔ 255	ROTATING GOBO FLOWING WATER EFFECT (SPEED 1 → 100%)
GOBO ROTATING		
CH.13	0 ↔ 127	0-360°
	128 ↔ 190	ROTATING GOBO POSITIVE ROTATION (SPEED 100% → 1)
	191 ↔ 192	STOP
	193 ↔ 255	ROTATING GOBO REVERSE ROTATION (SPEED 1 → 100%)
PRISM		
CH.14	0 ↔ 10	WHITE
	11 ↔ 145	PRISM 0-360°
	146 ↔ 150	STOP
	151 ↔ 200	PRISM INSERT AND POSITIVE ROTATION (SPEED 100% → 1)
	201 ↔ 205	STOP
	206 ↔ 255	PRISM INSERT AND REVERSE ROTATION (SPEED 1 → 100%)
FROST		
CH.15	000 ↔ 010	WHITE
	011 ↔ 255	FROST → 100%
IRIS		
CH.16	0 ↔ 127	IRIS 100%-0%
	128 ↔ 130	IRIS → OFF
	131 ↔ 171	IRIS FADE IN AND FAST OUT
	172 ↔ 211	IRIS FAST IN AND FADE OUT (SPEED 1 → 100%)
	212 ↔ 251	IRIS FADE IN AND FAST OUT RANDOMLY (SPEED 1 → 100%)
	252 ↔ 255	IRIS → OFF
CH.17	0 ↔ 255	ZOOM
AUTO FOCUS		
CH.18	0 ↔ 15	NO FUNCTION
	16 ↔ 63	5M
	64 ↔ 111	10M
	112 ↔ 159	15M
	160 ↔ 207	20M
	208 ↔ 255	25M
CH.19	0 ↔ 255	MANUAL FOCUS
CH.20	0 ↔ 255	DIMMER

1.3 Safety warning

IMPORTANT

[ALWAYS READ THE USER MANUAL BEFORE OPERATION.]
[PLEASE CONFIRM THAT THE POWER SUPPLY STATED ON THE PRODUCT IS THE SAME AS THE MAINS POWER SUPPLY IN YOUR AREA.]

- This product must be installed by a qualified professional.
- Always operate the equipment as described in the user manual.
- A minimum distance of 0.5m must be maintained between the equipment and combustible surface.
- The product must always be placed in a well ventilated area.
- Always make sure that the equipment is installed securely.
- Do not stand close to the equipment and stare directly into the LED light source.
- Always disconnect the power supply before attempting and maintenance.
- Always make sure that the supporting structure is solid and can support the combined weight of the products.
- The earth wire must always be connected to the ground.
- Do not touch the power cables if your hands are wet.

ATTENTION



- This product left the place of manufacture in perfect condition. In order to maintain this condition and for safe operation, the user must always follow the instructions and safety warnings described in this user manual.
- Avoid shaking or strong impacts to any part of the equipment.
- Make sure that all parts of the equipment are kept clean and free of dust.
- Always make sure that the power connections are connected correct and secure.
- If there is any malfunction of the equipment, contact your distributor immediately.
- When transferring the product, it is advisable to use the original packaging in which the product left the factory.
- Shields, lenses or ultraviolet screens shall be changed if they have become damaged to such an extent that their effectiveness is impaired.
- The lamp (LED) shall be changed if it has become damaged or thermally deformed.



Caution, risk of electric shock
The light source contained in this luminaire shall only be replaced by the manufacturer or his service agent or a similar qualified person.

2 Installation

2.1 Mounting

- The fixture can be mounted in any position.
- Always ensure that mounting surface can withstand 10 times the weight of the fixture.
- Always use a safety cable when mounting the fixture in any elevated position.

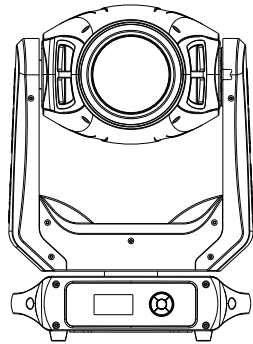

UPRIGHT

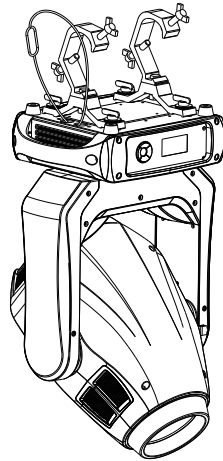

HANGING

IMPORTANT SAFETY NOTE!!

Always use a safety cable when installing this unit!!
Be sure that the safety cable is connected to a solid load-bearing structure.

035↔038	GOBO7
039↔042	GOBO8
043↔046	GOBO9
047↔050	GOBO10
051↔054	GOBO11
055↔058	GOBO12
059↔063	GOBO1 SHAKE (SPEED 1 → 100%)
064↔068	GOBO2 SHAKE (SPEED 1 → 100%)
069↔073	GOBO3 SHAKE (SPEED 1 → 100%)
074↔078	GOBO4 SHAKE (SPEED 1 → 100%)
079↔083	GOBO5 SHAKE (SPEED 1 → 100%)
084↔088	GOBO6 SHAKE (SPEED 1 → 100%)
089↔093	GOBO7 SHAKE (SPEED 1 → 100%)
094↔098	GOBO8 SHAKE (SPEED 1 → 100%)
099↔103	GOBO9 SHAKE (SPEED 1 → 100%)
104↔108	GOBO10SHAKE (SPEED 1 → 100%)
109↔113	GOBO11SHAKE (SPEED 1 → 100%)
114↔118	GOBO12SHAKE (SPEED 1 → 100%)
119↔127	WHITE
128↔190	STATIC GOBO FLOWING WATER EFFECT (SPEED 100%→1)
191↔192	STOP
193↔255	STATIC GOBO FLOWING WATER EFFECT (SPEED 1→100%)

ROTATING GOBO 8+1	
000↔010	WHITE
011↔016	GOBO1
017↔022	GOBO2
023↔028	GOBO3
029↔034	GOBO4
035↔040	GOBO5
041↔046	GOBO6
047↔052	GOBO7
053↔058	GOBO8
059↔066	GOBO1 SHAKE (SPEED 1 → 100%)
067↔074	GOBO2 SHAKE (SPEED 1 → 100%)
075↔082	GOBO3 SHAKE (SPEED 1 → 100%)
083↔090	GOBO4 SHAKE (SPEED 1 → 100%)
091↔098	GOBO5 SHAKE (SPEED 1 → 100%)
099↔106	GOBO6 SHAKE (SPEED 1 → 100%)

CH.12

	036 ↔ 037	6000K
	038 ↔ 039	6500K
	040 ↔ 041	6800K
	042 ↔ 043	L101
	044 ↔ 045	L194
	046 ↔ 047	L019
	048 ↔ 049	R08
	050 ↔ 051	L213
	052 ↔ 053	R80
	054 ↔ 055	L202
	056 ↔ 057	L328
	058 ↔ 059	R3314
	060 ↔ 061	L106
	062 ↔ 063	L768
	064 ↔ 255	MACRO EFFECT R->G->B->R
	COLOR WHEEL 8+1	
	000 ↔ 127	COLOR WHEEL 0-360°
	128 ↔ 134	COLOR01
	135 ↔ 141	COLOR02
	142 ↔ 148	COLOR03
	149 ↔ 155	COLOR04
CH.9	156 ↔ 162	COLOR05
	163 ↔ 169	COLOR06
	170 ↔ 176	COLOR07
	177 ↔ 183	COLOR08
	184 ↔ 191	WHITE
	192 ↔ 222	COLOR WHEEL RAINBOW EFFECT (SPEED 100%->1)
	223 ↔ 224	STOP
	225 ↔ 255	COLOR WHEEL RAINBOW EFFECT (SPEED 1-> 100%)
CH.10	000 ↔ 255	COLOR WHEEL FINE ADJUSTMENT. AVAILABLE WHEN THE VALUE IS UNDER 128 ON CHANNELS 10.
	STATIC GOBO 12+1	
	000 ↔ 010	WHITE
	011 ↔ 014	GOBO1
	015 ↔ 018	GOBO2
	019 ↔ 022	GOBO3
	023 ↔ 026	GOBO4
	027 ↔ 030	GOBO5
CH.11	031 ↔ 034	GOBO6

2.2 Fuse replacement

- Remove the safety cap by a screwdriver.
- Fetch the old fuse from safety cap.
- Install a new fuse.
- Install the safety cap.

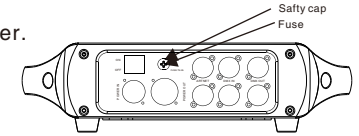

2.3 Power connections

This product uses input and output power cable is 1.5 square mm copper wire
Note:

If the signal cable is over 60m between the DMX512 controller and fixture or between two fixtures, then a DMX signal amplifier is needed as well.

This product provides for the use of input power and signal cables are three-core, the connection diagram is as follows

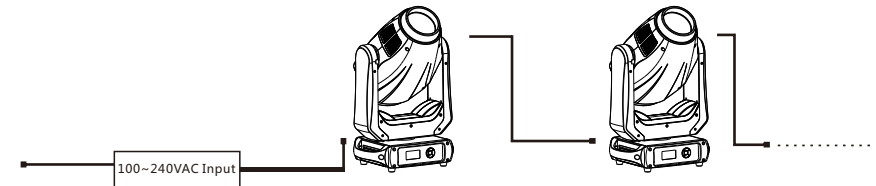

- When using this product to connect 220V AC, the number of tandem fixtures must not exceed six.
- When using this product to connect 110V AC, the number of tandem fixtures must not exceed two.

3 Display panel operation

3.1 Display operation

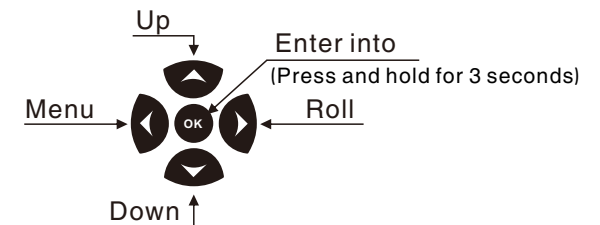

3.2 Menu

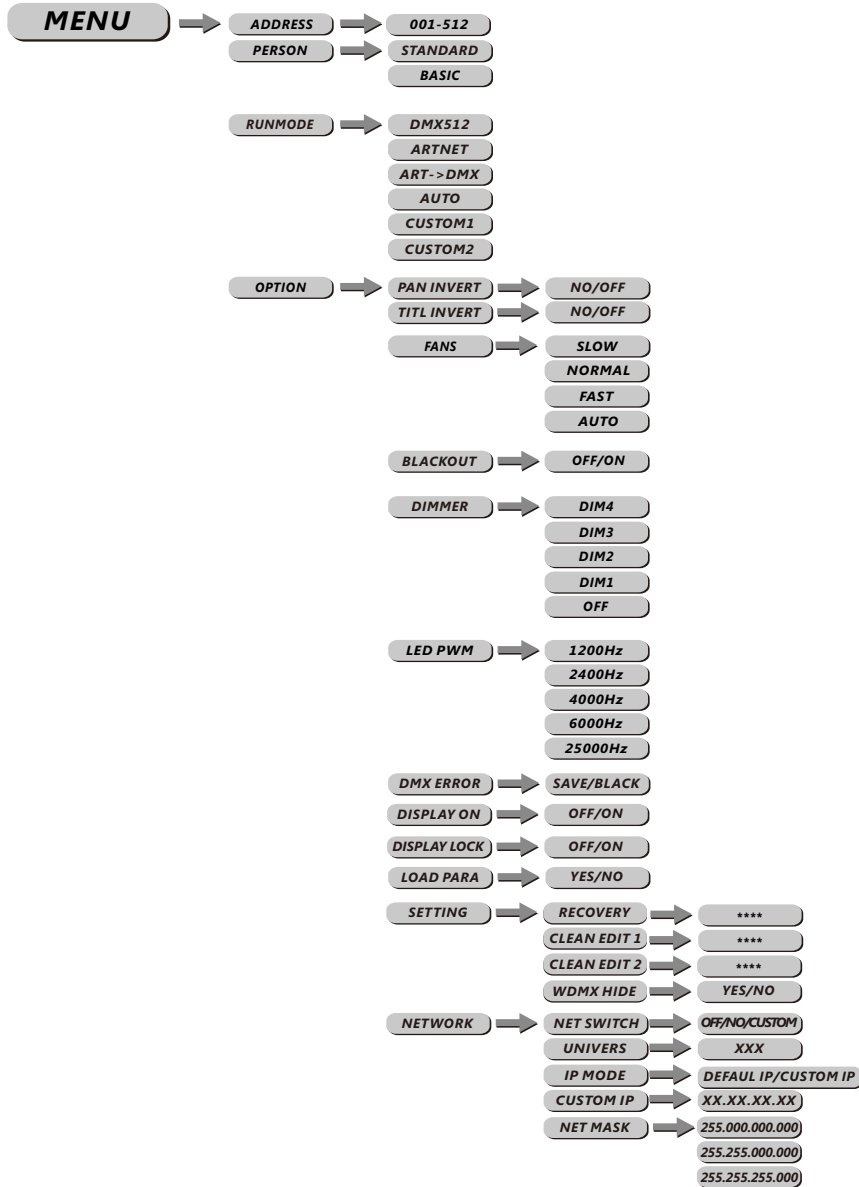

091 ↔ 100	FAN AUTO
101 ↔ 110	DIM4
111 ↔ 120	DIM3
121 ↔ 130	DIM2
131 ↔ 140	DIM1
141 ↔ 150	DIM0
151 ↔ 160	1200Hz
161 ↔ 170	2400Hz
171 ↔ 180	4000Hz
181 ↔ 190	6000Hz
191 ↔ 200	25000Hz
201 ↔ 210	ALL RESET
211 ↔ 220	XY RESET
221 ↔ 230	COLOR SYSTEM RESET
231 ↔ 240	GOBO RESET
241 ↔ 250	FOCUS\ZOOM\FROST\PRISM RESET
251 ↔ 255	NO FUNCTION

BASIC

CHANNEL	VALUE	FUNCTION
CH.1	000 ↔ 255	PAN 0-540°
CH.2	000 ↔ 255	TILT 0-270°
CH.3	000 ↔ 255	PT SPEED
CH.4	000 ↔ 255	CYAN
CH.5	000 ↔ 255	MAGENTA
CH.6	000 ↔ 255	YELLOW
CH.7	000 ↔ 255	CTO 8000K - 3000K
CMY MACRO		
	000 ↔ 019	No Function
	020 ↔ 021	3000K
	022 ↔ 023	3200K
	024 ↔ 025	3500K
	026 ↔ 027	4000K
	028 ↔ 029	4500K
	030 ↔ 031	5000K
	032 ↔ 033	5400K
CH.8	034 ↔ 035	5600K

CHANNEL	VALUE	FUNCTION
CH.17	FROST	
	000 ↔ 010	WHITE
	011 ↔ 255	FROST → 100%
CH.18	IRIS	
	0 ↔ 127	IRIS 100%-0%
	128 ↔ 130	IRIS → OFF
	131 ↔ 171	IRIS FADE IN AND FAST OUT
	172 ↔ 211	IRIS FAST IN AND FADE OUT (SPEED 1 → 100%)
	212 ↔ 251	IRIS FADE IN AND FAST OUT RANDOMLY (SPEED 1 → 100%)
252 ↔ 255	IRIS → OFF	
CH.19	0 ↔ 255	ZOOM
CH.20	AUTO FOCUS	
	0 ↔ 15	NO FUNCTION
	16 ↔ 63	5M
	64 ↔ 111	10M
	112 ↔ 159	15M
	160 ↔ 207	20M
208 ↔ 255	25M	
CH.21	0 ↔ 255	MANUAL FOCUS
CH.22	0 ↔ 255	DIMMER
CH.23	0 ↔ 255	16B DIMMER FINE
CH.24	STORBE	
	0 ↔ 9	NO FUNCTION
	10 ↔ 99	STROBE FROM (SLOW TO FAST ,0-25Hz)
	100 ↔ 109	NO FUNCTION
	110 ↔ 179	LIGHTNING STROBE
	180 ↔ 189	NO FUNCTION
190 ↔ 255	RANDOM STROBE	
CH.25	CONTROL	
	000 ↔ 010	NO FUNCTION
	011 ↔ 020	PAN/TILT BLACK ACTIVATED
	021 ↔ 030	PAN/TILT BLACK DEACTIVATED
	031 ↔ 040	PAN INVERT
	041 ↔ 050	TILT INVERT
	051 ↔ 060	PAN/TILT INVERT OFF
	061 ↔ 070	FAN SLOW
	071 ↔ 080	FAN NORMAL
	081 ↔ 090	FAN FAST

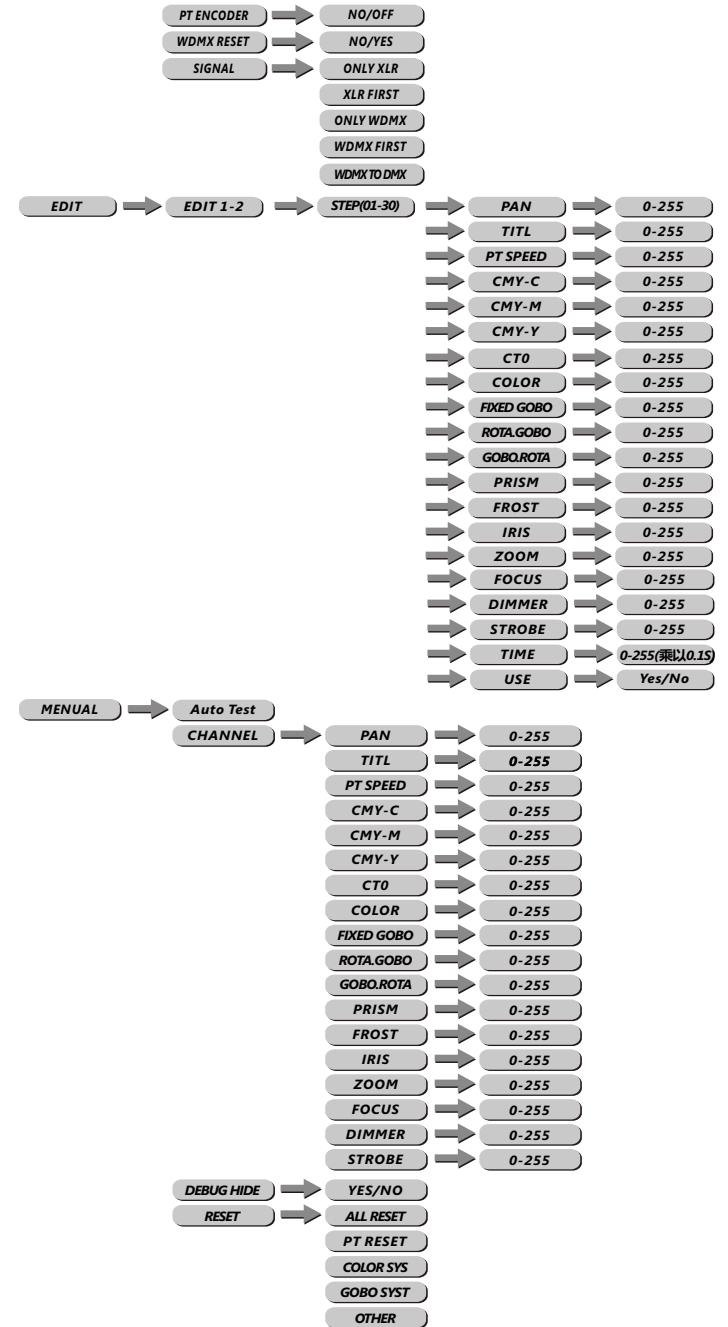

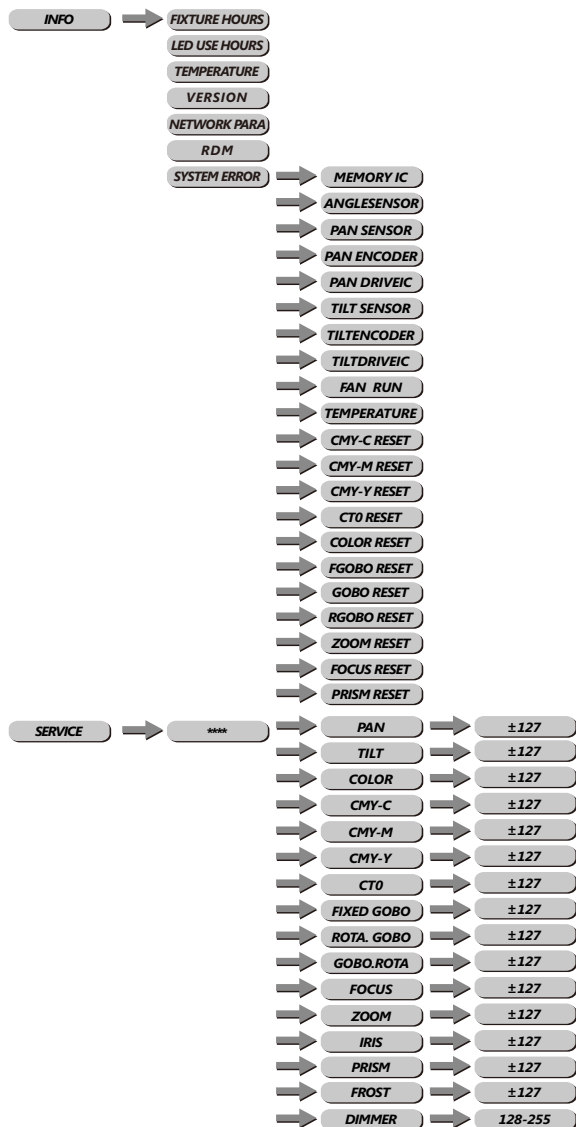

104↔108	GOBO10SHAKE (SPEED 1 → 100%)
109↔113	GOBO11SHAKE (SPEED 1 → 100%)
114↔118	GOBO12SHAKE (SPEED 1 → 100%)
119↔127	WHITE
128↔190	STATIC GOBO FLOWING WATER EFFECT (SPEED 100%→1)
191↔192	STOP
193↔255	STATIC GOBO FLOWING WATER EFFECT (SPEED 1→100%)
ROTATING GOBO 8+1	
000↔010	WHITE
011↔016	GOBO1
017↔022	GOBO2
023↔028	GOBO3
029↔034	GOBO4
035↔040	GOBO5
041↔046	GOBO6
047↔052	GOBO7
053↔058	GOBO8
CH.14 059↔066	GOBO1 SHAKE (SPEED 1 → 100%)
067↔074	GOBO2 SHAKE (SPEED 1 → 100%)
075↔082	GOBO3 SHAKE (SPEED 1 → 100%)
083↔090	GOBO4 SHAKE (SPEED 1 → 100%)
091↔098	GOBO5 SHAKE (SPEED 1 → 100%)
099↔106	GOBO6 SHAKE (SPEED 1 → 100%)
107↔114	GOBO7 SHAKE (SPEED 1 → 100%)
115↔122	GOBO8 SHAKE (SPEED 1 → 100%)
123↔127	WHITE
128↔190	ROTATING GOBO FLOWING WATER EFFECT (SPEED 100%→1)
191↔192	STOP
193↔255	ROTATING GOBO FLOWING WATER EFFECT (SPEED 1→100%)
GOBO ROTATING	
0 ↔127	0-360°
CH.15 128↔190	ROTATING GOBO POSITIVE ROTATION (SPEED 100%→1)
191↔192	STOP
193↔255	ROTATING GOBO REVERSE ROTATION (SPEED 1→100%)
PRISM	
0 ↔10	WHITE
11 ↔145	PRISM 0-360°
146↔150	STOP
CH.16 151↔200	PRISM INSERT AND POSITIVE ROTATION (SPEED 100%→1)
201↔205	STOP
206↔255	PRISM INSERT AND REVERSE ROTATION (SPEED 1→100%)

CHANNEL	VALUE	FUNCTION
CH.11	COLOR WHEEL 8+1	
	000↔127	COLOR WHEEL 0-360°
	128↔134	COLOR01
	135↔141	COLOR02
	142↔148	COLOR03
	149↔155	COLOR04
	156↔162	COLOR05
	163↔169	COLOR06
	170↔176	COLOR07
	177↔183	COLOR08
	184↔191	WHITE
	192↔222	COLOR WHEEL RAINBOW EFFECT (SPEED 100%->1)
	223↔224	STOP
	225↔255	COLOR WHEEL RAINBOW EFFECT (SPEED 1->100%)
CH.12	000↔255	COLOR WHEEL FINE ADJUSTMENT. AVAILABLE WHEN THE VALUE IS UNDER 128 ON CHANNELS 10.
CH.13	STATIC GOBO 12+1	
	000↔010	WHITE
	011↔014	GOBO1
	015↔018	GOBO2
	019↔022	GOBO3
	023↔026	GOBO4
	027↔030	GOBO5
	031↔034	GOBO6
	035↔038	GOBO7
	039↔042	GOBO8
	043↔046	GOBO9
	047↔050	GOBO10
	051↔054	GOBO11
	055↔058	GOBO12
	059↔063	GOBO1 SHAKE (SPEED 1 → 100%)
	064↔068	GOBO2 SHAKE (SPEED 1 → 100%)
	069↔073	GOBO3 SHAKE (SPEED 1 → 100%)
	074↔078	GOBO4 SHAKE (SPEED 1 → 100%)
	079↔083	GOBO5 SHAKE (SPEED 1 → 100%)
	084↔088	GOBO6 SHAKE (SPEED 1 → 100%)
089↔093	GOBO7 SHAKE (SPEED 1 → 100%)	
094↔098	GOBO8 SHAKE (SPEED 1 → 100%)	
099↔103	GOBO9 SHAKE (SPEED 1 → 100%)	

3.3 DMX Address



- ◆ Enter the **【DMX】** mode to set the DMX address.
- ◆ Enter UP/DOWN select **【1-512】** address.
- ◆ Enter **【MENU】** return.

3.4 Personality(Person)



- ◆ Enter the **【PERSON】** mode to select DMX mode: **【STANDRAD】**, **【BASIC】**.

3.5 Runmode

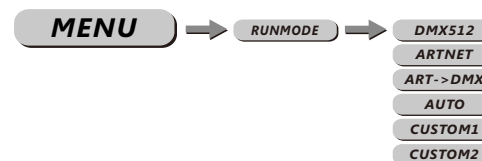

- ◆ **【RUNMODE】** menu, select required run mode, There are six modes inside: **【DMX512】** DMX512 Mode, **【ARTNET】** Artnet Mode, **【ARTNET->DMX】** ARTNET to DMX Mode, **【AUTO】** Auto run Mode, **【CUSTOM1】** Customer self-editing scene mode1, **【CUSTOM2】** Customer self-editing scene mode2 Press **【DOWN】** / **【UP】** select mode, Press **【ENTER】** accept, Press **【MENU】** return.

3.6 Performance(Option)

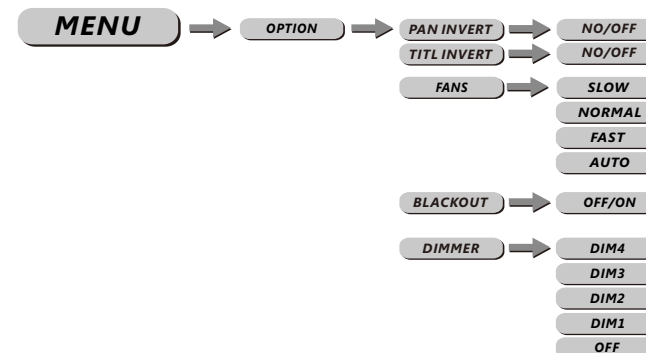

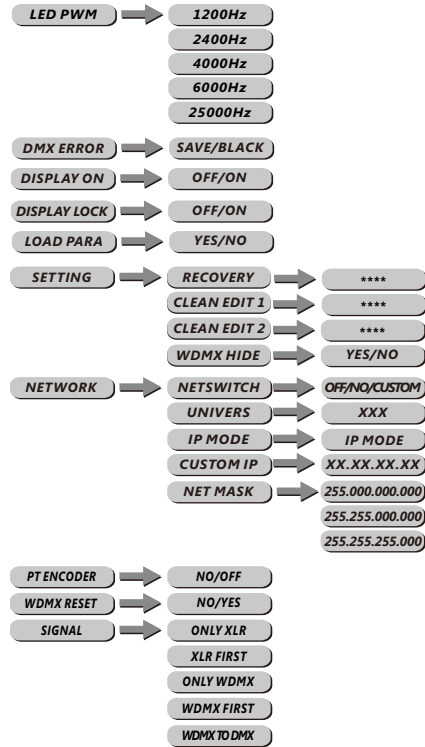

- ◆ Enter **【OPTION】** into the machine set.
- ◆ **【PAN INVERT】** menu, select **【NORMAL】** for normal direction, select **【INVERT】** for inverted of the PAN direction.
- ◆ **【FANS】** menu, select **【Slow/Norm/Fast/Auto】** as required fan speed.
- ◆ Choose **【OFF】** and **【ON】** to close and open the **【BLACKOUT】** mode.
- ◆ **【DIMMER】** menu for selection of **【DIM1/DIM2/DIM3/DIM4/OFF】** special dimming curves.
- ◆ **【LED PWM】** is PWM refresh rate bottom, press UP/DOWN to choose <1200Hz> , <2000Hz>、<2400Hz>、<6000Hz>、<25000Hz>;
Attention: The gray level of dimming will be reduced as the refresh rate increases.
- ◆ **【DMXerror】** menu, select **【SAVE】** to maintain last command in case of DMX error or **【BLACK】** for blackout.
- ◆ Choose **【OFF】** and **【ON】** to close and open the display open & close mode in menu **【DISPLAY】**
- ◆ Choose **【OFF】** and **【ON】** to close and open the screen lock mode in menu **【DISPLAY LOCK】**
- ◆ **【LOAD PARA】** is Parameter upload Settings, enter **【NO】** do not upload, enter **【YES】** upload.

STANDARD

CHANNEL	VALUE	FUNCTION
CH.1	000 ↔ 255	PAN 0-540°
CH.2	000 ↔ 255	PAN FINE
CH.3	000 ↔ 255	TITL 0-270°
CH.4	000 ↔ 255	TITL FINE
CH.5	000 ↔ 255	PT SPEED
CH.6	000 ↔ 255	CYAN
CH.7	000 ↔ 255	MAGENTA
CH.8	000 ↔ 255	YELLOW
CH.9	000 ↔ 255	CT0 8000K - 3000K
CMY MACRO		
	000 ↔ 019	No Function
	020 ↔ 021	3000K
	022 ↔ 023	3200K
	024 ↔ 025	3500K
	026 ↔ 027	4000K
	028 ↔ 029	4500K
	030 ↔ 031	5000K
	032 ↔ 033	5400K
	034 ↔ 035	5600K
	036 ↔ 037	6000K
	038 ↔ 039	6500K
CH.10	040 ↔ 041	6800K
	042 ↔ 043	L101
	044 ↔ 045	L194
	046 ↔ 047	L019
	048 ↔ 049	R08
	050 ↔ 051	L213
	052 ↔ 053	R80
	054 ↔ 055	L202
	056 ↔ 057	L328
	058 ↔ 059	R3314
	060 ↔ 061	L106
	062 ↔ 063	L768
	064 ↔ 255	MACRO EFFECT R->G->B->R

3.10 Service

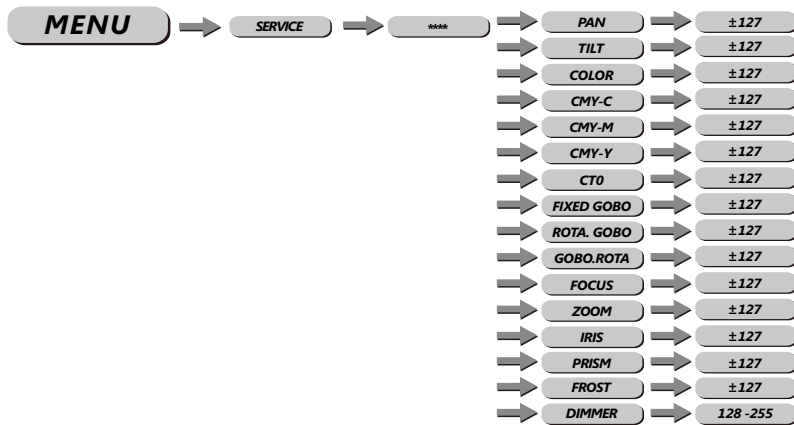

◆ Press **【ENTER】** into **【SERVICE】** Enter password to enter the options page.

- 【PAN】** Pan position fine adjustment, Push up and down buttons adjust ± 127 value.
- 【TILT】** Tilt position fine adjustment, Push up and down buttons adjust ± 127 value.
- 【COLOR】** Color position fine adjustment, Push up and down buttons adjust ± 127 value.
- 【CMY-C】** CMY-C position fine adjustment, Push up and down buttons adjust ± 127 value.
- 【CMY-M】** CMY-M position fine adjustment, Push up and down buttons adjust ± 127 value.
- 【CMY-Y】** CMY-Y position fine adjustment, Push up and down buttons adjust ± 127 value.
- 【CT0】** CMY-Y position fine adjustment, Push up and down buttons adjust ± 127 value.
- 【FIXED GOBO】** Fix gobo position fine adjustment, Push up and down buttons adjust ± 127 value.
- 【ROTA.GOBO】** Rotation gobo position fine adjustment, Push up and down buttons adjust ± 127 value.
- 【GOBO.ROTA】** Gobo self-rotation position fine adjustment, Push up and down buttons adjust ± 127 value.
- 【FOCUS】** Focus position fine adjustment, Push up and down buttons adjust ± 127 value.
- 【ZOOM】** Zoom position fine adjustment, Push up and down buttons adjust ± 127 value.
- 【IRIS】** Iris position fine adjustment, Push up and down buttons adjust ± 127 value.
- 【PRISM】** Prism position fine adjustment, Push up and down buttons adjust ± 127 value.

4 Using a DMX512 Controller

4.1 Channel Assignment

- ◆ Note: This product have two DMX512 channel configuration: **【STANDARD】** , **【BASIC】** .

- ◆ **【SETTING】** Maintain Settings, select **【RECOVERY】** is restore default factory Settings. Press **【ENTER】** Enter password then press **【ENTER】** ,if your password correct there will display **【OK】** .
【CLEAN EDIT1】 clean Customer self-editing scene 1, press **【ENTER】** confirm.
【CLEAN EDIT2】 clean Customer self-editing scene 2, press **【ENTER】** confirm.
【WDMX HIDE】 hide wireless mode, WDMX RESET and SIGNAL hide and the default is wired mode only.
- ◆ **【NETWORK】** network setting, press **【ENTER】** in, Depending on the mode, you can hide unwanted features. For example Net Switch=Off IP Mode=Default.
【UNIVERS】 Packet group Settings , output grouping 0~255.
【IP MODE】 IP mode setting, **【DEFAULTIP】** is default IP, **【CUSTOM IP】** is customer's IP.
【CUSTOM IP EDIT】 is customer's IP setting.
【NET MASK】 Subnet Mask Settings.
- ◆ **【PT ENCODER】** XY Encoder switch, **【OFF】** is close, **【ON】** is open.
- ◆ **【WDMX RESET】** wireless resetting, use for patch wireless signal, **【YES】** is Clear the receiver's message, press again patch wireless signal, **【No】** do not clear the receiver's message.

3.7 Edit

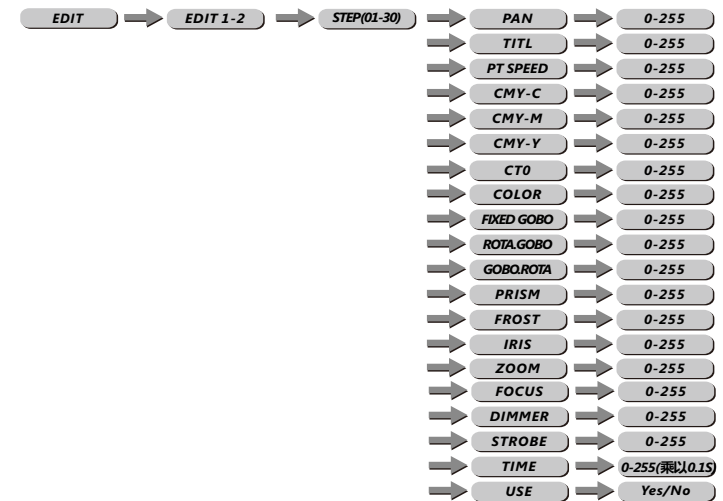

- ◆ Enter the **【Edit】** mode to edit the custom programs by adjusting the value of **【PAN】** , **【TILT】** , **【PT SPEED】** , **【CMY-C】** , **【CMY-M】** , **【CMY-Y】** , **【CT0】** , **【COLOR】** , **【FIXED GOBO】** , **【ROTA.GOBO】** , **【GOBO.ROTA】** , **【PRISM】** , **【FROST】** , **【IRIS】** , **【ZOOM】** , **【FOCUS】** , **【DIMMER】** , **【STROBE】** , **【TIME】** .
- ◆ Enter **【Use】** and select **【Yes】** to run the steps user need.

3.8 Manual control mode

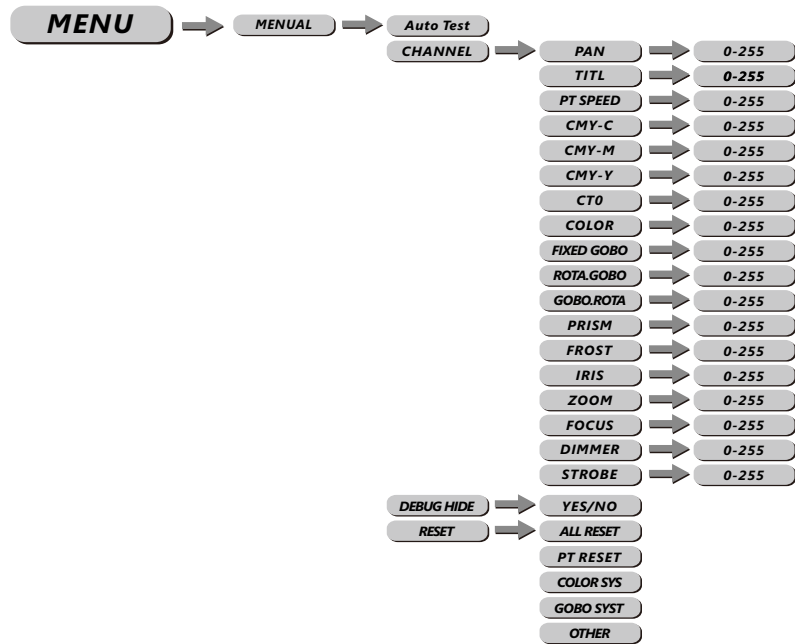

- ◆ **【PAN】** pan set, **【TILT】** tilt set, **【PT SPEED】** set the pan & tilt speed, **【CMY-C】** CMY red, **【CMY-M】** CMY blue , **【CMY-Y】** CMY yellow , **【CT0】** Color wheel set, **【COLOR】** color temperature, **【FIXED GOBO】** set the static gobo wheel, **【ROTA.GOBO】** set the rotating gobo wheel, **【GOBO.ROTA】** set the autogiration of gobo wheel, **【PRISM】** set the prism, **【FROST】** set thefrost lens, **【IRIS】** set the iris, **【ZOOM】** set the zoom of fixture, **【FOCUS】** set the focusing, **【DIMMER】** set the dimmer, **【STROBE】** set the strobe, push theUP/DOWN to set the value **【000~255】** .
- ◆ **【DEBUG HIDE】** is the factory testing mode.All stepper motors are not controlled by signal , It only works again after the reset. enter **【NO】** out、 enter **【YES】** in.
- ◆ **【RESET】** set the reset:
【ALL RESET】 menu, select **【YES/NO】** to carry out all reset.
【COLOR SYS】 color wheel、 CMY resetting, press **【NO】** do not resetting, press **【YES】** resetting.
【PT RESET】 menu, select **【YES/NO】** to carry out PAN/TILT reset.
【OTHER】 focus、 zoom、 prism、 frost、 iris, press **【NO】** do not resetting, press **【YES】** resetting.
【GOBO SYST】 fix gobo resetting. press **【NO】** do not resetting, press **【YES】** resetting.

3.9 Info

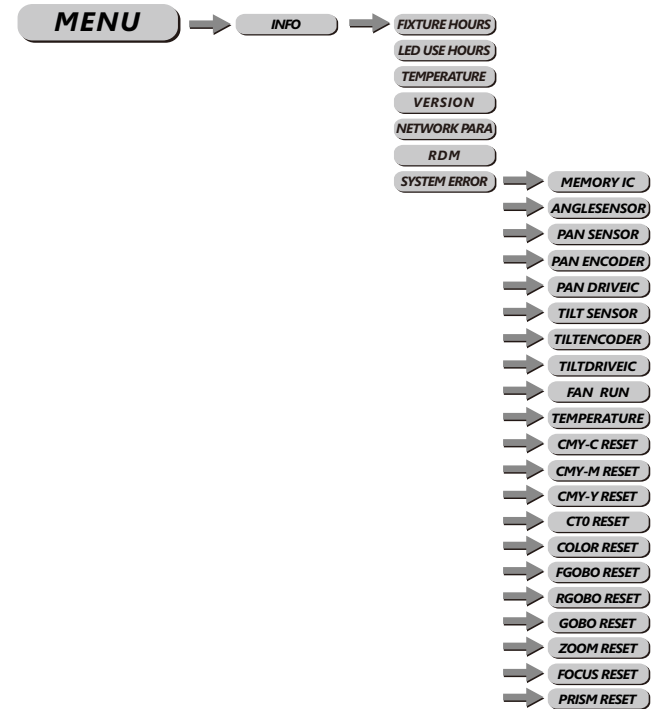

- ◆ Press **【ENTER】** into **【INFO】** check information, press up and down
【FIXTURE HOURS】 is hours of fixture use;
【LED USE HOURS】 is LED use time;
【TEMPERATURE】 is led temperature.
【VERSION】 is software versions;
【NETWORK PARA】 check network parameter;
【RDM】 check fixture's ID;
【SYSTEM ERROR】 System information error: Memory IC, Angle Sensor, Pan Sensor, Pan Encoder, Pan Drive IC, Tilt Sensor, TiltEncoder, TiltDriveIC, FAN RUN, Temperature, CMY-C Reset, CMY-M Reset, CMY-Y Reset, CT0 Reset,Color Reset, FGobo Reset, Gobo Reset, RGobo Reset, Zoom Reset, Focus Reset, Prism Reset.