

oppo®

USER MANUAL

READ CAREFULLY BEFORE OPERATION

ULTRA HD Blu-ray Disc Player

UDP-205

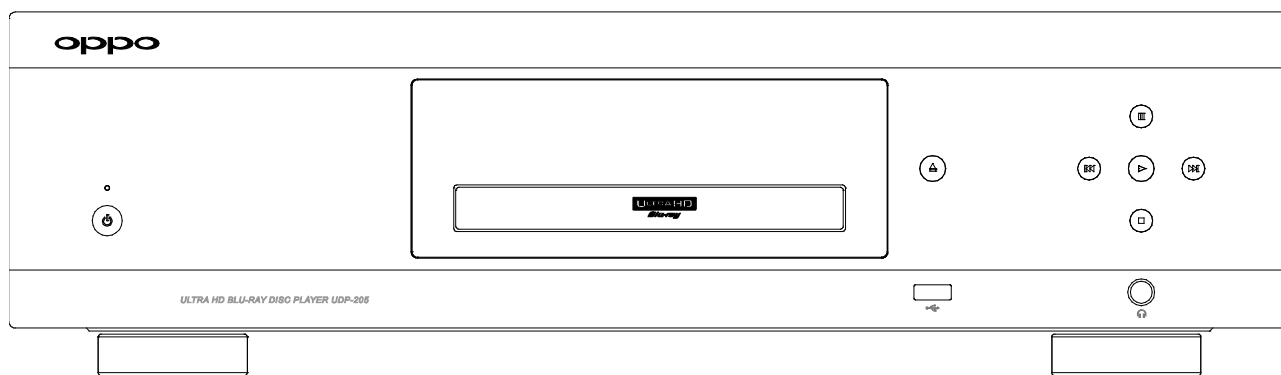



Table of Contents

IMPORTANT INFORMATION	1
Important Safety Instructions	1
Precautions.....	2
FCC Statement	2
Trademarks.....	3
Compatible Disc Types	3
Discs that cannot be played.....	4
Notes about BD-ROM compatibility	4
Disc care and handling	4
Cinavia Notice	4
Region management information	4
Accessories	5
INTRODUCTION	6
Front Panel Controls	6
Front Panel Display Window	6
Rear Panel Connectors	7
Remote Control	8
Remote Control Buttons	8
Back Side.....	9
Battery Installation.....	9
Using the Remote Control	9
Changing the Remote Code	10
Motion Sensitive Backlight.....	10
Common Connection Methods	12
Connecting to an A/V Receiver via HDMI	12
Connecting to a TV via HDMI.....	13
Connecting to a TV and A/V Receiver via Dual HDMI	14
Connecting to a Stereo Audio System through RCA-style Cable	15
Connecting to a Stereo Audio System through XLR Balanced Cable.....	16
Connecting to an A/V Receiver or Amplifier via Analog Outputs.....	17
Connecting to an A/V Receiver or Amplifier via S/PDIF (Coaxial / Optical)	18
HDMI INPUT to UDP-205	19
Digital Audio Input (Optical, Coaxial, USB) to UDP-205	20
Connecting to the Internet	21
Internet Connection via Ethernet Cable	21
Internet Connection via Wi-Fi	22
RS232 Control.....	23

BASIC OPERATIONS	24
Disc Playback	24
OPTION Menu	24
Fast Forward and Reverse	25
Pause and Frame-by-Frame	26
Slow Playback	26
Blu-ray Disc Menu Navigation	26
DVD Menu Navigation	27
On-Screen Display	27
Volume Control	28
Mute	28
Audio Language/Track Selection	28
Subtitle Selection	29
HDMI INPUT Selection	29
Digital Audio Input Selection	29
Audio Return Channel (ARC) Selection	29
BD-Live	30
ADVANCED OPERATIONS	31
Zooming and Aspect Ratio Control	31
Zoom Levels for HDMI Output	31
Subtitle Shift	33
Repeat Playback	33
Repeat a Selected Section	34
Shuffle and Random Playback	34
Playback by Chapter or Track Number	34
Playback from a Specific Location	35
DVD and Blu-ray Discs	35
CD and SACD discs	36
Memory and Automatic Resume	37
Viewing Pictures on DVD-Audio Discs	37
Pure Audio Mode	38
MEDIA FILE PLAYBACK	39
Playback from a USB Flash Drive	39
Playback from a Home Network	40
HOME Menu	41
Playing Music Files	41
Playing Movie Files	43
Viewing Photo Files	44
Adding Background Music	45
SETUP MENU OPTIONS	46

Using the Setup Menu System.....	46
Playback Setup.....	49
Video Output Setup	52
Picture Adjustment	56
Select the Best Output Resolution	57
Determine the Display Aspect Ratio	58
Audio Output Setup	59
Audio Signal Reference Chart	62
Recommended Audio Format Options.....	63
Audio Processing Setup	65
Speaker Configuration.....	68
Device Setup	72
Network Setup.....	76
Useful Notes.....	80
Troubleshooting	80
Specifications.....	82
User Manual Updates Online.....	83
Language Code List.....	84
RS-232 Control Protocol	85
LIMITED WARRANTY	95
OPPO Digital, Inc. Limited Two Years Warranty.....	95

IMPORTANT INFORMATION



CAUTION
RISK OF ELECTRIC SHOCK
DO NOT OPEN.



CAUTION: TO REDUCE THE RISK OF ELECTRIC SHOCK, DO NOT REMOVE COVER (OR BACK). NO USER-SERVICEABLE PARTS INSIDE. REFER SERVICING TO QUALIFIED SERVICE PERSONNEL.



The lightning flash with arrowhead symbol, within an equilateral triangle, is intended to alert the user to the presence of uninsulated "dangerous voltage" within the product's enclosure that may be of sufficient magnitude to constitute a risk of electric shock to persons.



The exclamation point within an equilateral triangle is intended to alert the user to the presence of important operation and maintenance (servicing) instruction in the literature accompanying the appliance.

WARNING:

TO REDUCE THE RISK OF FIRE OR ELECTRIC SHOCK, DO NOT EXPOSE THIS APPLIANCE TO RAIN OR MOISTURE. DANGEROUS HIGH VOLTAGES ARE PRESENT INSIDE THE ENCLOSURE. DO NOT OPEN THE CABINET. REFER SERVICING TO QUALIFIED PERSONNEL ONLY.

THE APPARATUS SHALL NOT BE EXPOSED TO DRIPPING OR SPLASHING AND THAT NO OBJECTS FILLED WITH LIQUIDS, SUCH AS VASES SHALL BE PLACED ON THE APPARATUS.

Important Safety Instructions

- 1) Read these instructions.
- 2) Keep these instructions.
- 3) Heed all warnings.
- 4) Follow all instructions.
- 5) Do not use this apparatus near water.
- 6) Clean only with dry cloth.
- 7) Do not block any ventilation openings. Install in accordance with the manufacturer's instructions.
- 8) Do not install near any heat sources such as radiators, heat registers, stoves, or other apparatus (including amplifiers) that produce heat.
- 9) Do not defeat the safety purpose of the polarized or grounding-type plug. A polarized plug has two blades with one wider than the other. A grounding type plug has two blades and a third grounding prong. The wide blade or the third prong is provided for your safety. If the provided plug does not fit into your outlet, consult an electrician for replacement of the obsolete outlet.
- 10) Protect the power cord from being walked on or pinched, particularly at plug, receptacle, and the point

CAUTION:

DANGER OF EXPLOSION IF BATTERY IS INCORRECTLY REPLACED. REPLACE ONLY WITH THE SAME OR EQUIVALENT TYPE.

THIS PRODUCT UTILIZES A LASER. USE OF CONTROLS OR ADJUSTMENTS OR PERFORMANCE OF PROCEDURES OTHER THAN THOSE SPECIFIED HEREIN MAY RESULT IN HAZARDOUS RADIATION EXPOSURE. DO NOT OPEN COVERS AND DO NOT REPAIR YOURSELF. REFER SERVICING TO QUALIFIED PERSONNEL.

**CLASS I LASER
PRODUCT**

CAUTION CLASS 3R VISIBLE AND INVISIBLE LASER RADIATION WHEN OPEN. AVOID DIRECT EYE EXPOSURE.

VORSICHT KLASSE 3R SICHTBARE UND UNSICHTBARE LASERSTRAHLUNG WENN GEÖFFNET. UNMITTELBAREN AUGENKONTAKT VERMEIDEN.

ADVARSEL SYNLIG OG USYNLIG LASERSTRÅLING AF KLASSE 3R VED ÅBNING. UNDGÅ AT SE DIREKTE PÅ STRÅLEN.

ADVARSEL SYNLIG OG USYNLIG LASERSTRÅLING I KLASSE 3R NÅR DEKSEL ÅPNES. UNNGÅ DIREKTE EKSPONERING AV ØYENENE.

VARNING KLASSE 3R SYNLIG OCH OSYNLIG LASERSTRÅLNING NÅR DENNA DEL ÄR ÖPPNAD. UNDVIK ATT DIREKT EXPONERA ÖGONEN FÖR STRÅLNINGEN.

VARO! AVATTUNA LUOKAN 3R NÄKYVÄÄ JA NÄKYMÄTÖNTÄ LASERSÄTEILYÄ. VÄLTÄ KATSEEN SUORAA ALTISTAMISTA.

警告 打开时有3R类可见和不可见激光辐射, 避免眼睛受到直射的照射

This label is located on the laser protective housing inside the product.

where it exits from the apparatus.

- 11) Only use attachments/accessories specified by the manufacturer.
- 12) Use only with the cart, stand, tripod, bracket, or table specified by the manufacturer, or sold with the apparatus. When a cart is used, use caution when moving the cart/apparatus combination to avoid injury from tip-over.
- 13) Unplug this apparatus during lightning storms or when unused for long periods of time.
- 14) Refer all servicing to qualified service personnel. Servicing is required when the apparatus has been damaged in any way, such as power-supply cord or plug is damaged, liquid has been spilled or objects have fallen into the apparatus, the apparatus has been exposed to rain or moisture, does not operate normally, or has been dropped.
- 15) Batteries (battery pack or batteries installed) shall not be exposed to excessive heat such as sunshine, fire or the like.



Precautions

- Before connecting the AC power cord to the appliance, make sure the voltage designation of the appliance corresponds to the local electrical supply. If you are unsure of your power supply, contact your local power company. The acceptable power input range is AC 110V–120V~ / 220V–240V~, 50/60Hz.
- The apparatus with CLASS I construction shall be connected to a MAINS socket outlet with a protective earthing connection.
- The player is still receiving power from the AC power source as long as it is connected to the wall outlet, even if the player itself has been turned off.
- Unplug the power cord if you are not going to use the product for an extended period of time. Hold the power plug when unplugging. Do not pull on the cord.
- The main plug is used as the mechanism for cutting off power, therefore make sure it is easy to unplug.
- To ensure proper ventilation around this product, do not place this product on a sofa, bed or rug. When installing this product on a wall or bookshelf, you need to provide appropriate space: we recommend leaving 4 inches (10 cm) of free space at the top, the sides and the rear.
- High temperature will lead to abnormal operation of this unit. Do not expose this unit or batteries to direct sunlight or near other heating objects.
- When moving the player from a cold location to a warm one, or vice versa, moisture may condense on the laser pickup unit inside the player. Should this occur, the player may not operate properly. In such a case please turn the unit on for 1-2 hours (without a disc) to facilitate moisture evaporation.

FCC Statement

This equipment has been tested and found to comply with the limits for a Class B digital device, pursuant to Part 15 of the FCC Rules. These limits are designed to provide reasonable protection against harmful interference in a residential installation. This equipment generates, uses, and can radiate radio frequency energy and, if not installed and used in accordance with the instructions, may cause harmful interference to radio communications. However, there is no guarantee that interference will not occur in a particular installation. If this equipment does cause harmful interference to radio or television reception, which can be determined by turning the equipment off and on, the user is encouraged to try to correct the interference by one or more of the following measures:

- Reorient or relocate the receiving antenna.

- Increase the separation between the equipment and receiver.
- Connect the equipment into an outlet on a circuit different from that to which the receiver is connected.
- Consult the dealer or an experienced radio/TV technician for help.

Any unauthorized changes or modifications to this equipment would void the user's authority to operate this device.

This device complies with Part 15 of the FCC Rules. Operation is subject to the following two conditions: (1) This device may not cause harmful interference, and (2) this device must accept any interference received, including interference that may cause undesired operation.

Trademarks

- “ULTRA HD Blu-ray”, “Blu-ray Disc”, “Blu-ray 3D”, “BONUSVIEW” and “BD-Live” are trademarks of Blu-ray Disc Association.
- Java and all Java-based trademarks and logos are trademarks or registered trademarks of Sun Microsystems, Inc. in the United States and other countries.
- DVD Logo is a trademark of DVD Format/Logo Licensing Corp., registered in the U.S., Japan and other countries.
- Super Audio CD, SACD and the SACD logo are joint trademarks of Sony Corporation and Philips Electronics N.V. Direct Stream Digital (DSD) is a trademark of Sony Corporation.
- “AVCHD” and the “AVCHD” logo are trademarks of Panasonic Corporation and Sony Corporation.
- “480i/480p/720p/1080i/1080p” up-converting arrow logo, “Source Direct” and “True 24p” logos are trademarks of OPPO Digital, Inc.



- For DTS patents, see <http://patents.dts.com>. Manufactured under license from DTS Licensing Limited. DTS, the Symbol, DTS in combination with the Symbol, the DTS-HD logo, and DTS-HD Master Audio are registered trademarks or trademarks of DTS, Inc. in the United States and/or other countries. © DTS, Inc. All Rights Reserved.



- Manufactured under license from Dolby Laboratories. Dolby, Dolby Audio and the double-D symbol are trademarks of Dolby Laboratories.
- HDMI, the HDMI logo and High-Definition Multimedia Interface are trademarks or registered trademarks of HDMI Licensing LLC.
- “Cinavia” is trademark of Verance Corporation.
- All other trademarks are the properties of their respective owners.

Compatible Disc Types

Logo	Features	Manual Icon
 	BD: Supports 4K Ultra HD Blu-ray and Blu-ray with Bonus View and BD-Live content, including Blu-ray 3D discs. A 3D-capable display with compatible glasses is required for 3D playback. BD-R/RE, both single- and dual-layer are also supported.	
	DVD: Plays commercially-released DVDs, as well as finalized DVD±R/RW.	
	DVD-A: High-resolution stereo or multi-channel audio. Some DVD-Audio discs also contain a DVD-Video portion.	
	SACD: High-resolution stereo or multi-channel audio. Note: some SACDs use a hybrid format with both a CD and a high resolution DSD layer.	
	CD: Supports standard Red Book CDs, as well as CD-R/RW.	
	AVCHD: High-definition digital video camera format, often in the form of a DVD±R or flash memory.	

Discs that cannot be played

- BDs with cartridge
- DVD-RAMs
- HD-DVDs
- Data portion of CD-Extras
- DVDs / Blu-Rays with a region code not matching the player's region code
- Some Dual-Discs: A Dual-Disc is a two-sided disc with DVD-video on one side and digital audio on the other side. The digital audio side does not meet the technical specifications of the Red Book CD format so playback is not guaranteed.
- Audio discs with copy-protection may not be playable.

Notes about BD-ROM compatibility

Since the Blu-ray Disc specifications are new and evolving, some discs may not play properly depending on the disc type, version and encoding. It is possible that a Blu-ray Disc manufactured after the player uses new features of the Blu-ray Disc specifications. To ensure the best possible viewing experience, the player may need a firmware or software update from time to time. Please visit OPPO Digital's web site www.oppodigital.com to check if updates are available.

Disc care and handling

- To keep the disc clean from scratches or fingerprints, handle the disc by its edge. Do not touch the recorded surface.
- Blu-ray Discs record data in very high density and the recorded layer is very close to the disc surface. For this reason, Blu-ray Discs are more sensitive to dust and fingerprints than DVD. Should you encounter playback problems and see dirty spots on the disc surface, clean the disc with a cleaning cloth. Wipe the disc from the center out along the radial direction. Do not wipe the disc in a circular motion.
- Do not use record cleaning sprays or solvents such as benzene, thinner and anti-static spray.
- Do not attach labels or stickers to discs as this may cause the disc to warp or become too thick, resulting in playback issues and a potentially stuck disc.
- Avoid exposing the discs to direct sunlight or heat sources.
- Do not use the following discs:
 - Discs with exposed adhesive from removed stickers or labels. The disc may get stuck inside the player.
 - Warped or cracked discs.
 - Irregularly shaped discs, such as heart or business card shapes.

Cinavia Notice

This product uses Cinavia technology to limit the use of unauthorized copies of some commercially-produced film and videos and their soundtracks. When a prohibited use of an unauthorized copy is detected, a message will be displayed and playback or copying will be interrupted.

This product incorporates proprietary technology under license from Verance Corporation and is protected by U.S. Patent 7,369,677 and other U.S. and worldwide patents issued and pending as well as copyright and trade secret protection for certain aspects of such technology. Cinavia is a trademark of Verance Corporation. Copyright 2004-2013 Verance Corporation. All rights reserved by Verance. Reverse engineering or disassembly is prohibited.

This update includes Cinavia® content protection technology. Information about Cinavia technology is provided at the Cinavia Online Consumer Information Center at <http://www.cinavia.com>.

More information about Cinavia technology is provided at the Cinavia Online Consumer Information Center at <http://www.cinavia.com>. To request additional information about Cinavia by mail, send a postcard with your mailing address to: Cinavia Consumer Information Center, P.O. Box 86851, San Diego, CA, 92138, USA.

Region management information

This player is designed and manufactured to respond to the region management information. If the region number of a BD-Video or DVD disc does not correspond to the region number of this player, this player cannot play the disc.

IMPORTANT INFORMATION

BD-Video: Blu-Ray Discs with marks containing the region code A.

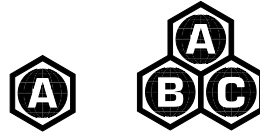

DVD-Video: DVDs with marks containing the region code 1 and ALL.



Accessories

Please check that the following parts are included in your UDP-205 package:



User Manual



Premium High Speed HDMI Cable, about 6 feet



Power Cable, about 4.5 feet



Remote Control with AA Batteries

INTRODUCTION

Front Panel Controls

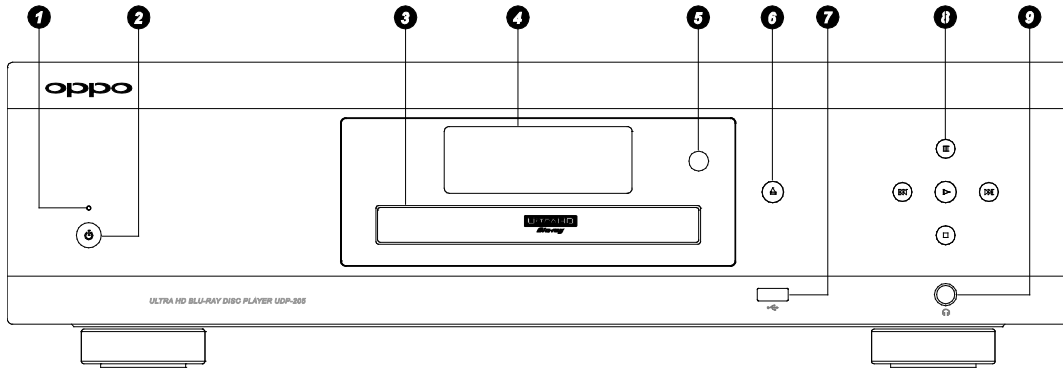

- | | | |
|-------------------------------|---------------------------|---|
| 1. POWER Status Indicator | 5. IR Sensor Window | 8. Playback Controls and Navigation Buttons |
| 2. POWER Button | 6. OPEN/CLOSE Tray Button | 9. 1/4-inch Stereo Headphone Jack (6.3mm) |
| 3. Disc Tray | 7. USB 2.0 Input | |
| 4. Front Panel Display Window | | |

Front Panel Display Window

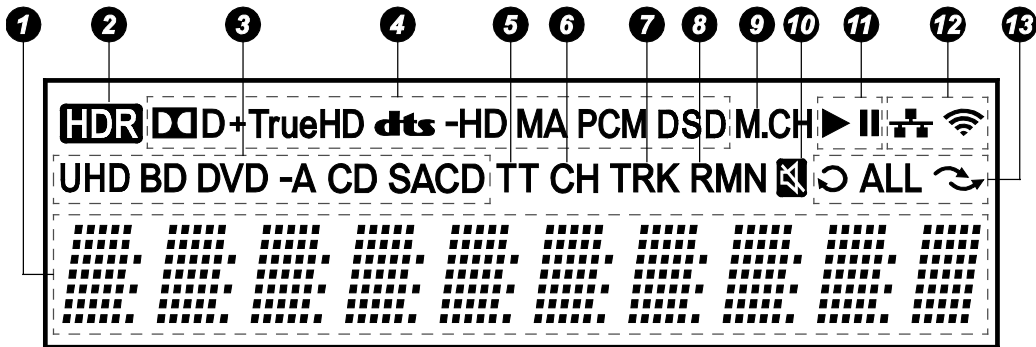

- | | |
|--|---|
| 1. Main Display – Text messages and numeric display | 8. Remaining – When illuminated, the displayed time is the remaining play time |
| 2. HDR Icon – Indicates the current playing content is High-Dynamic Range | 9. Multi-channel Indication – Indicates the audio being played is multi-channel surround |
| 3. Disc Type Indication – Indicates the currently playing disc type | 10. Mute Icon – Indicates that the audio is muted |
| 4. Audio Type Indication – Indicates the type of audio tracks being played | 11. Playback Status – Indicates playback status such as Play, Pause |
| 5. Title – When illuminated, the displayed time applies to a title | 12. Network Status – Indicates that the player is connected to a wired / wireless network |
| 6. Chapter – When illuminated, the displayed time applies to a chapter | 13. Playback Modes – Indicates playback modes such as Repeat, Repeat All, and Random Mode |
| 7. Track – When illuminated, the displayed time applies to a track | |

Rear Panel Connectors

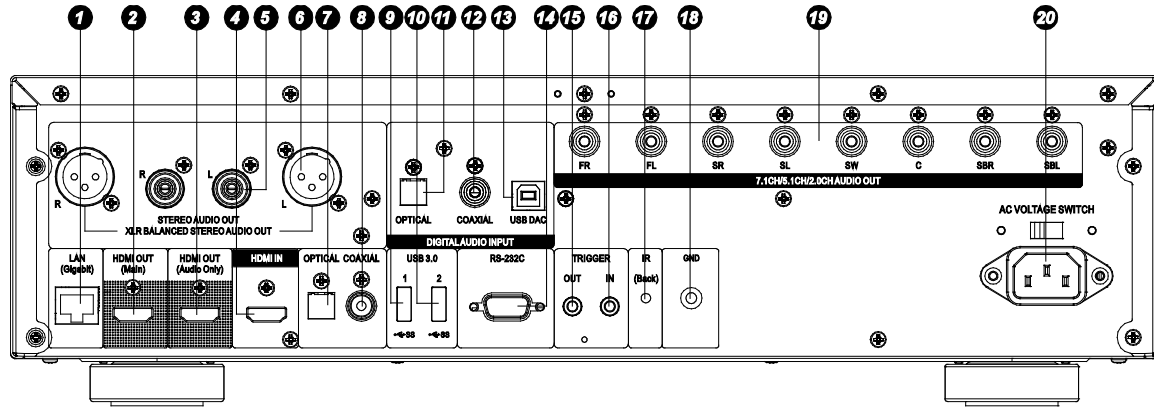

- | | | |
|---------------------------------|---------------------------------|--|
| 1. Gigabit Ethernet LAN Port | 8. Coaxial Digital Audio Output | 15. Trigger Output |
| 2. HDMI Output (Main) | 9. USB 3.0 Input | 16. Trigger Input |
| 3. HDMI Output (Audio Only) | 10. USB 3.0 Input | 17. IR (Infrared) Sensor |
| 4. HDMI Input | 11. Optical Digital Audio Input | 18. Ground |
| 5. Stereo Audio Output | 12. Coaxial Digital Audio Input | 19. 7.1CH / 5.1CH / Stereo Analog Audio Output |
| 6. Balanced Stereo Audio Output | 13. USB (Type B) Audio Input | 20. AC Power Inlet |
| 7. Optical Digital Audio Output | 14. RS-232C Serial Control Port | |

The AC power inlet is the IEC60-320 C14 type. Only the included AC power cord or an approved power cord with an IEC60-320 C14 type plug should be used.

Remote Control

Remote Control Buttons

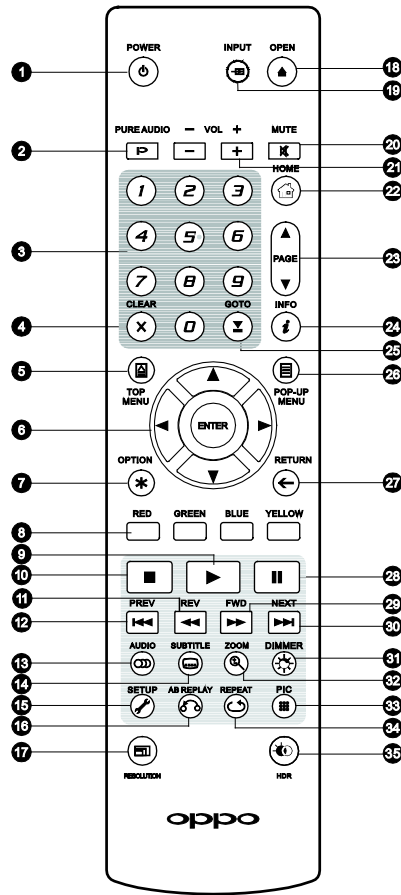

1. **POWER:** Toggle power STANDBY and ON
2. **PURE AUDIO:** Turn off/on video
3. **NUMBER Buttons:** Enter numeric values
4. **CLEAR:** Clear numeric input
5. **TOP MENU:** Show BD top menu or DVD title menu
6. **ARROW and ENTER Buttons:** Navigate menu selection
7. **OPTION:** Brings up the context-related menu
8. **COLOR Buttons:** Function varies by content
9. **PLAY:** Start playback
10. **STOP:** Stop playback
11. **REV:** Fast reverse play
12. **PREV:** Skip to previous
13. **AUDIO:** Change audio language or channel
14. **SUBTITLE:** Change subtitle language
15. **SETUP:** Enter the player Setup Menu
16. **A-B REPLAY:** Repeat play the selected section
17. **RESOLUTION:** Switch output resolution
18. **OPEN:** Open/close the disc tray
19. **INPUT:** Switch input source
20. **MUTE:** Mute audio
21. **VOLUME +/-:** Increase/Decrease volume
22. **HOME:** Go to Home Menu to select media source
23. **PAGE UP/DOWN:** Show the previous/next page
24. **INFO:** Show/hide the On-Screen Display
25. **GOTO:** Play from a specified location
26. **POP-UP MENU:** Show BD pop-up menu or DVD menu
27. **RETURN:** Return to the previous menu or mode
28. **PAUSE:** Pause playback
29. **FWD:** Fast forward play
30. **NEXT:** Skip to the next
31. **DIMMER:** Dim the front panel display
32. **ZOOM:** Zoom in/out and adjust aspect ratio
33. **PIC:** Quick access to the picture adjustment menu
34. **REPEAT:** Repeat play
35. **HDR:** Choose the output mode for High-Dynamic Range content

NOTE

- When a button is pressed but its function is invalid or unavailable at the moment, the TV screen displays a circle with a diagonal line:



Back Side

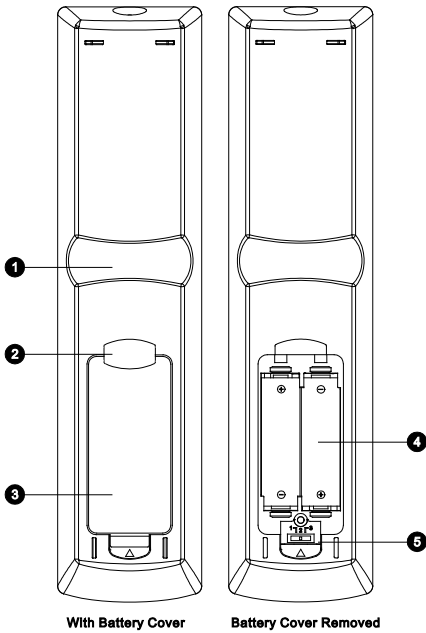

1. **Index Finger Notch 1:** When your index finger is placed at this notch while holding the remote control, your thumb is within easy reach of the navigation buttons (ARROW, ENTER, TOP MENU and POP-UP MENU).
2. **Index Finger Notch 2:** When your index finger is placed at this notch while holding the remote control, your thumb is within easy reach of the playback control buttons (STOP, PLAY, PAUSE, PREV, NEXT, REV, FWD).
3. **Battery Cover:** Remove to replace batteries or set remote code.
4. **Batteries:** Use 2 AA or LR6 batteries.
5. **Remote Code Switch:** Adjust the position of the switch to set the remote control to use the indicated remote code (see details on page 10).

Battery Installation

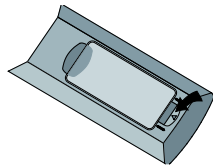

1. Remove the battery compartment cover

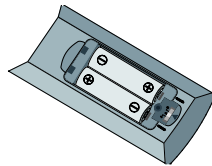

2. Insert batteries

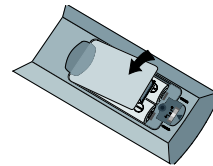

3. Replace the battery compartment cover

Using the Remote Control

When using the remote control, the front window of the remote control should be pointed to the infrared sensor on the front panel within an angle of $\pm 30^\circ$ and a range of about 26 ft.

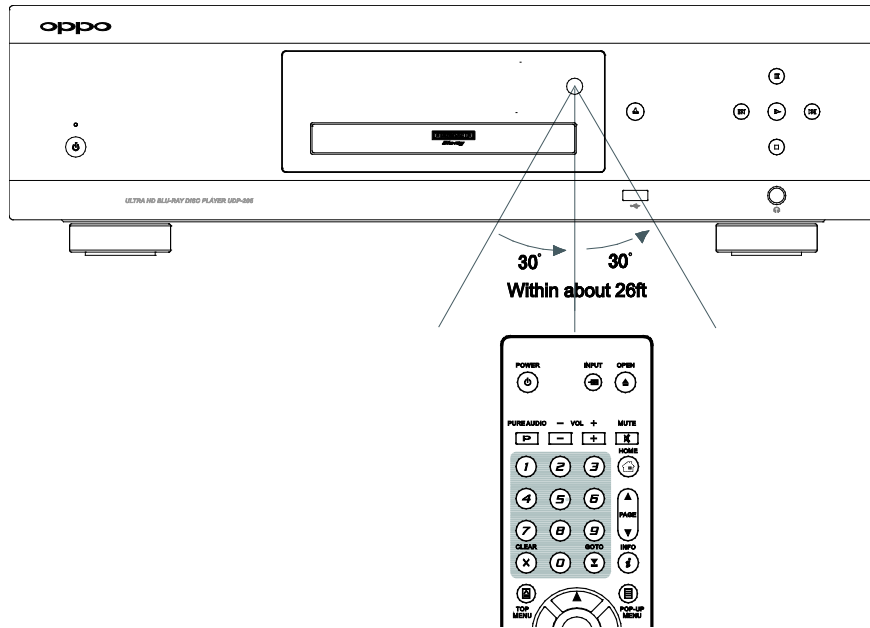

Changing the Remote Code

The remote control contains three OPPO remote codes. The default is Code 1. If you have other OPPO products placed close to the UDP-205, they may inadvertently respond to the UDP-205 remote control. To prevent this, you can select a different remote code.

To select a new remote code, open the battery compartment cover of the remote control, and then use a ball point pen to flip the switch to one of the positions marked as 1, 2, or 3. Close the battery compartment cover. Make sure that the UDP-205 player is turned on and that the disc tray is ejected. Aim the remote control at the player. Press and hold the **ENTER** button for 5 seconds. The player will start using the new remote code.

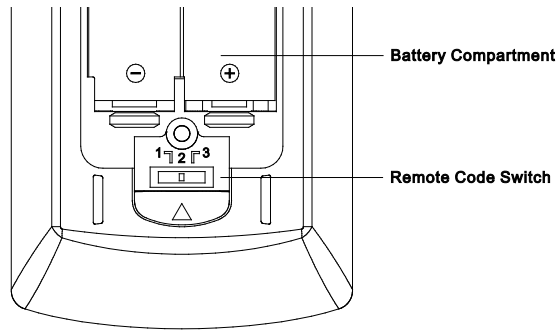

Motion Sensitive Backlight

The remote control features a motion sensor to activate the backlight for five seconds when you pick up the remote or press a button on the remote.

To disable or enable the backlight, press the **DIMMER** and **0** buttons at the same time on your remote.

CAUTION

- Never drop the remote control or expose it to moisture.
- Never expose the infrared remote sensor on the front panel to direct sunlight or other strong light sources.
- Remote may not operate consistently when batteries become low. Replace them if operation deteriorates.
- If the remote control will not be used for a long time, please remove the batteries.
- Use the batteries correctly to avoid possible leakage and corrosion. Do not leave the batteries exposed to direct sunlight or in a high temperature environment for a long period of time. Do not heat or expose to flame. Do not mix old and new batteries. Do not use batteries of different types at the same time. Do not attempt to recharge the batteries.
- If battery leakage occurs, do not touch the liquid with bare hands. Wipe out any liquid inside the battery compartment, and insert new batteries.

Common Connection Methods

Connecting to an AV Receiver via HDMI

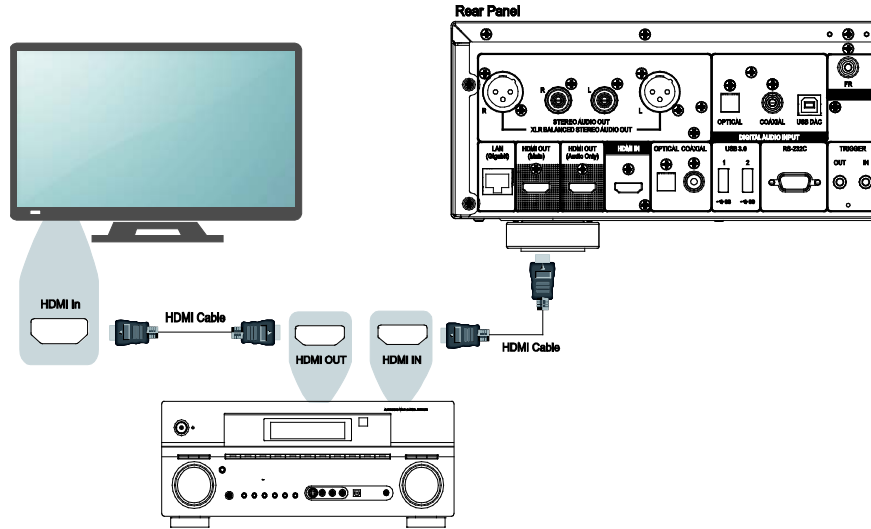

- If you have an HDMI-capable receiver that supports 4K HDR video pass-through, you can simply run an HDMI cable from the player's HDMI OUT (Main) output into your receiver and enable HDMI video pass-through on the receiver (see your receiver's owner's manual for more information). The receiver usually has an HDMI output that you can connect to your TV to pass the video signal.
- Some receivers contain a mixture of HDMI 2.0 and HDMI 1.4 ports. In order to view 4K UHD content, ensure that you are connecting the UDP-205's HDMI OUT (Main) output into an HDMI 2.0 and HDCP 2.2 compliant input of the receiver.

NOTE

- HDMI (High-Definition Multimedia Interface) is a single cable that can transport both audio and video from your player to your display. Be aware, however, that HDMI is an evolving standard, and there may be compatibility issues. A receiver that supports audio input over HDMI is required. Some receivers offer HDMI ports solely for video switching. If your receiver does not have audio input capability, please read the following sections regarding other connection methods.
- For Blu-ray Discs, a receiver that supports HDMI 1.4 or later with decoding capability for Dolby TrueHD and DTS-HD Master Audio is preferred.
- For 4K UHD Blu-ray discs, a receiver that supports HDMI 2.0 and HDCP 2.2 or later is required. It is recommended to use an 18 Gbps Premium High-Speed HDMI Cable to watch 4K UHD movies.
- The UDP-205 supports bitstreaming the latest object-based surround audio formats, such as Dolby Atmos and DTS:X to a receiver that can decode these formats.
- Please check the specifications of your receiver to ensure that it meets these requirements.

Connecting to a TV via HDMI

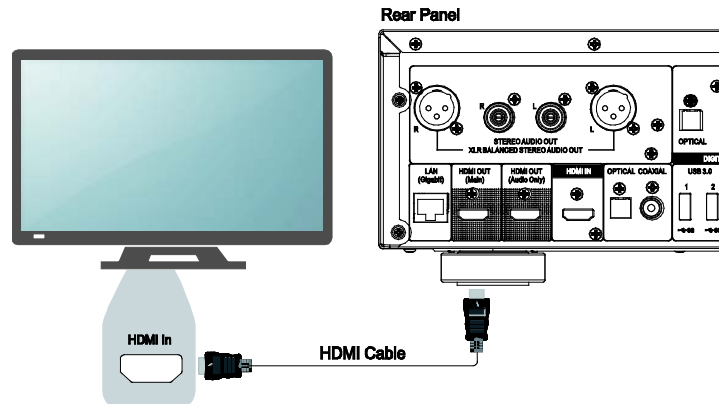

- Use an HDMI cable to connect the player's HDMI OUT (Main) output directly into your TV. This connection method delivers both audio and video in a pure digital format via a single cable.
- In order to play 4K UHD content, you must connect the UDP-205's HDMI OUT (Main) output into an HDMI 2.0 and HDCP 2.2 compliant input of the 4K UHD TV.

NOTE

- This connection method will output sound via the TV's speakers. For optimal sound quality, it is recommended that audio be transferred from the UDP-205 to an A/V receiver with connected speakers.
- You will need a UHD TV that supports HDMI 2.0 and HDCP 2.2 in order to watch UHD Blu-Ray and other UHD content in 4K resolution.
- You will need an HDR-capable TV to watch HDR content.
- You will need an 18 Gbps High-Speed HDMI Cable to watch UHD movies at 4K@60.
- Do not connect the HDMI OUT (Audio Only) output to your TV.

Connecting to a TV and A/V Receiver via Dual HDMI

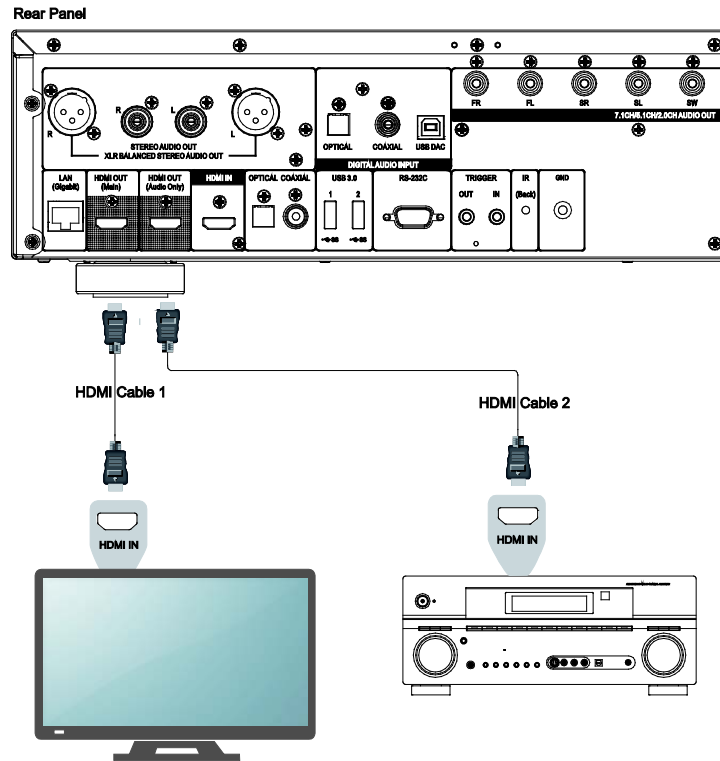

- The UDP-205's Dual HDMI connection mode ensures that you can enjoy the highest possible video quality and resolution, in addition to high bit rate audio content. Use an HDMI cable to connect the HDMI OUT (Main) output to your TV, and another HDMI cable to connect the HDMI OUT (Audio Only) output to your receiver.
- This configuration is recommended when you have a 3D or UHD compatible display, but your receiver is not 3D or UHD compatible. This configuration will allow you to send the video signal (3D or UHD in this case) directly to the TV and send the audio signal to the receiver.

NOTE

- Please refer to the notes on HDMI connections available on page 12.
- If your receiver does not have HDMI audio input capability, please try the alternate connection methods discussed on pages 15 through 18.

Connecting to a Stereo Audio System through RCA-style Cables

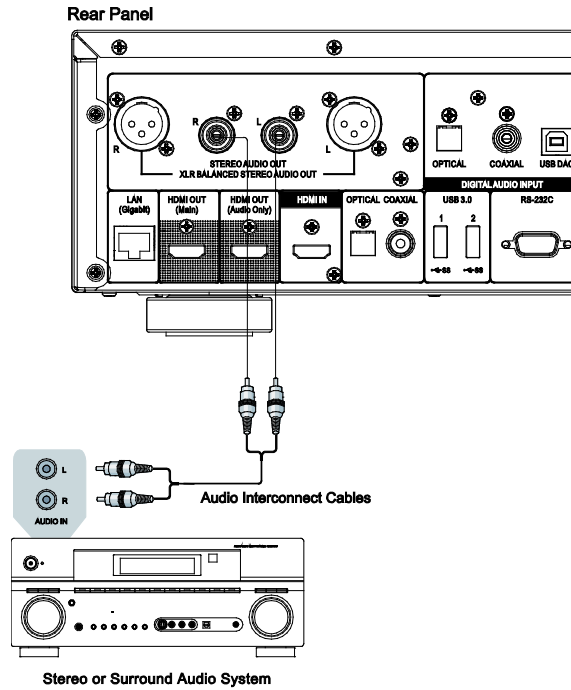

- If your audio system offers only stereo audio inputs, or if you would like to connect a dedicated stereo audio system in addition to the surround audio system which is already connected to the HDMI, coaxial or optical outputs, you can connect the dedicated stereo audio system to the STEREO AUDIO OUT terminals of the player.
- Two sets of dedicated stereo audio outputs are available on the UDP-205: the **RCA-style** connectors and the **XLR balanced** connectors (shown in the next page). Preference should be given to the XLR connectors since they may provide better noise rejection and signal integrity (refer to page 17 for more information).

NOTE

- The STEREO AUDIO OUT terminals automatically down-mix the multi-channel audio source into the stereo signals. However, STEREO AUDIO OUT will NOT be affected by the “Down Mix” modes and other speaker settings in the **Audio Processing** section of the **Setup Menu** (described on page 65).

Connecting to a Stereo Audio System through XLR Balanced Cables

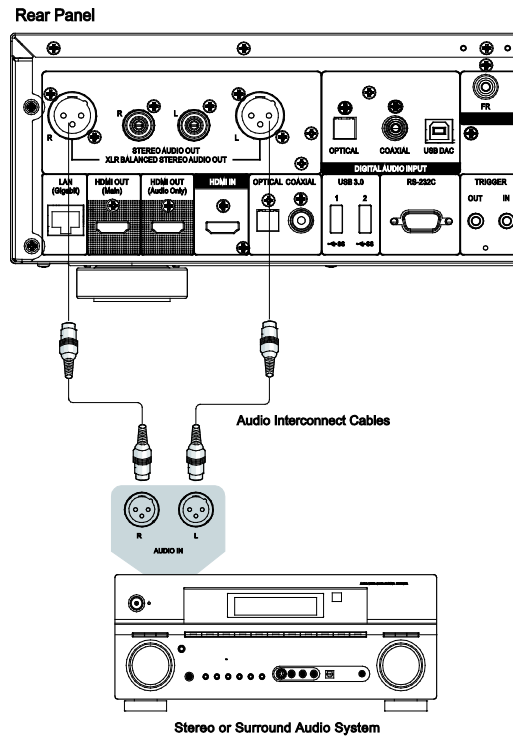

- You can also connect the BALANCED STEREO AUDIO OUT to your stereo audio system. Three-pin (XLR3) cables are needed, and the XLR terminals on the player are male type.

NOTE

- Balanced audio connectors are used mostly in professional audio electronics, such as high quality microphones and inter-equipment connections. The UDP-205 utilizes the 3-pin XLR connector (shown below), which transmits a pair of differential signals (positive /negative). The amplifier extracts the voltage difference between differential signals, thus the common noise can be rejected and the signal integrity is improved.
- In some audio systems the positions of "hot" (positive) and "cold" (negative) pins are switched. In this case please set "**XLR Terminal Polarity**" to "**Inversion**" in the **Audio Processing** of **Setup Menu**.

XLR Terminal (male) Pins on UDP-205

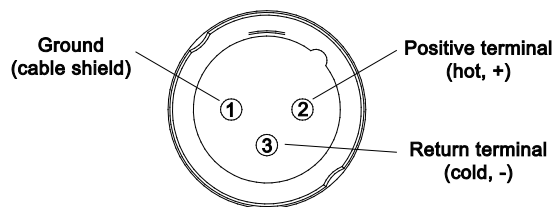

Connecting to an AV Receiver or Amplifier via Analog Outputs

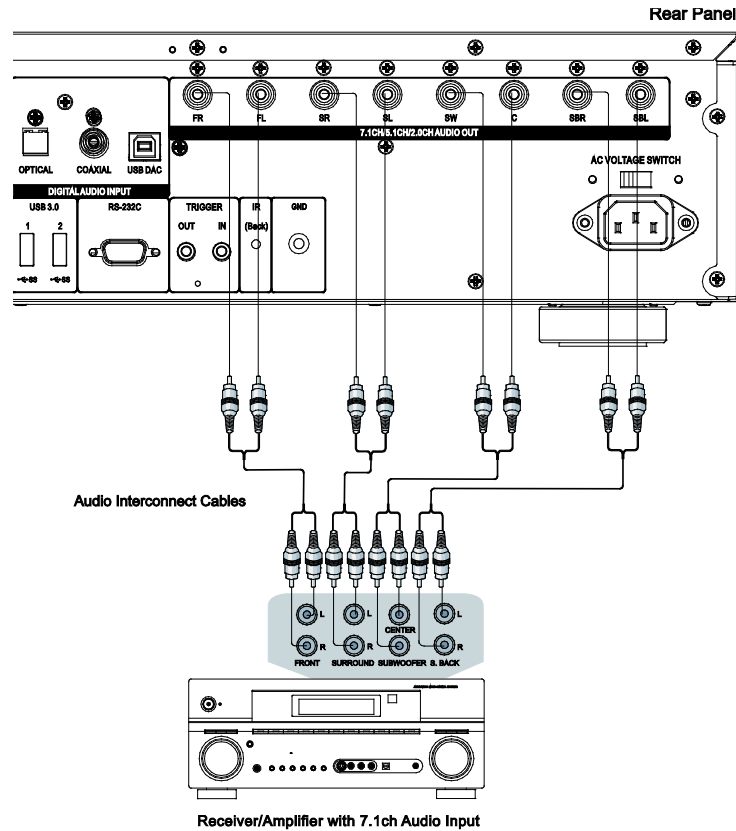

- The UDP-205 is equipped with a 7.1ch analog audio output section that can be connected to the 7.1ch analog input section of an A/V receiver or amplifier for audio output. This method is required if the A/V receiver does not have HDMI inputs. It is also a preferred connection method for taking advantage of the UDP-205's advanced digital-to-analog converter (DAC).
- Please use up to 8 RCA-style audio interconnect cables to connect the FL (Front Left), FR (Front Right), SL (Surround Left), SR (Surround Right), C (Center), SW (Subwoofer), SBL (Surround Back Left) and SBR (Surround Back Right) analog output terminals of the UDP-205 to the corresponding multi-channel analog audio input jacks of your A/V receiver or amplifier.
- If the A/V receiver or amplifier only has 5.1ch audio inputs, you can omit the SBL (Surround Back Left) and SBR (Surround Back Right) outputs. In the **Setup Menu**, set the **Down Mix Mode** to **5.1ch** in the **Speaker Configuration** section (refer to **Down Mix Mode** on page 68).
- If your audio system offers only stereo audio inputs, or if you would like to connect a dedicated stereo audio system in addition to the surround audio system which is already connected to the HDMI or S/PDIF outputs, you can connect the dedicated stereo audio system to the FL (Front Left) and FR (Front Right) outputs of the player. In the **Setup Menu**, set the **Down Mix Mode** to **Stereo** in the **Speaker Configuration** section (refer to **Down Mix Mode** on page 68).

Connecting to an AV Receiver or Amplifier via S/PDIF (Coaxial / Optical)

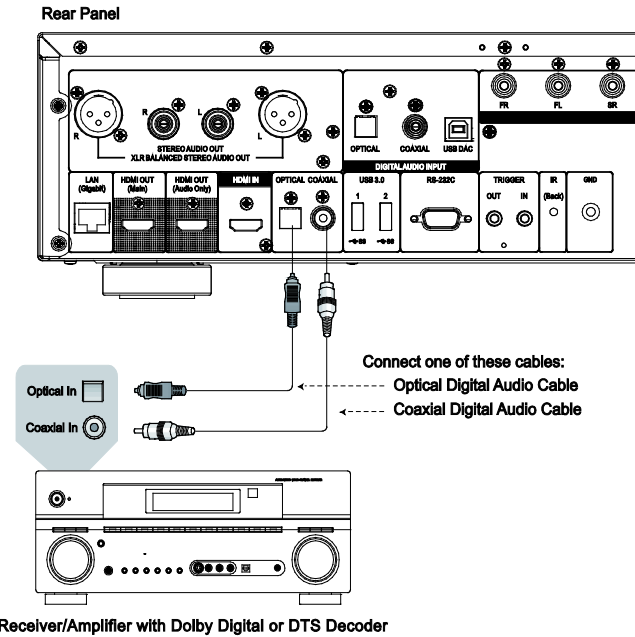

- Please use either a 75-Ohm coaxial digital audio cable with RCA-style connectors or an S/PDIF optical digital audio cable to connect one of the digital audio outputs to the corresponding input terminal on your A/V receiver. For detailed setup of coaxial/optical signals, refer to page 60.

NOTE

- Due to bandwidth limitations, high resolution audio formats such as Dolby Digital Plus, Dolby TrueHD, DTS-HD High Resolution and DTS-HD Master Audio cannot be sent through the coaxial or optical digital audio output. A reduced resolution version of the same audio track will be output instead. To listen to high resolution audio formats in their best quality, please use the HDMI connection if you have a receiver that handles HDMI audio (see page 12) or use the multi-channel analog outputs if you do not (see page 15).
- Due to copyright restrictions, SACD audio cannot be sent through the coaxial or optical digital audio output. To listen to SACDs, please use the HDMI or analog audio connections.
- Due to copyright restrictions and bandwidth limitations, full resolution audio from DVD-Audio discs cannot be sent through the coaxial or optical digital audio output. To listen to DVD-Audio in full resolution, please use the HDMI or analog audio connections.

HDMI INPUT to UDP-205

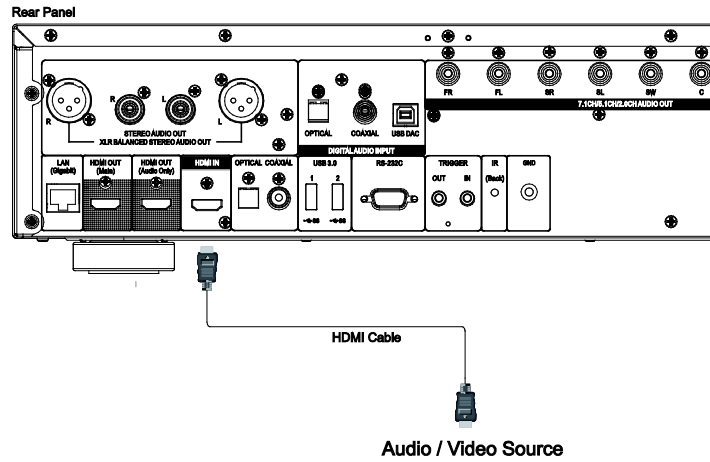

- The HDMI IN port on the rear of the player allows for the connection of native 4K content from external sources such as a streaming set-top box, cable/satellite boxes, game consoles, computers and even other Blu-ray and UHD players. The incoming signal is processed by the player and output to your connected devices, allowing you to take advantage of the player's built-in audio and video processing capabilities.
- Use the **INPUT** button on the OPPO remote to select **HDMI IN** from the input menu.

Digital Audio Input (Optical, Coaxial, USB) to UDP-205

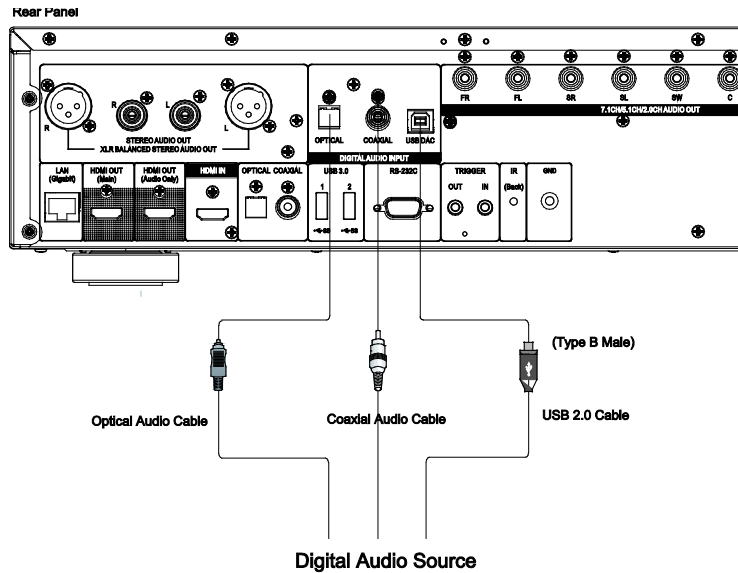

- The UDP-205 can function as a dedicated Digital-to-Analog Converter (DAC) and process external digital audio signals with its internal SABRE³² Reference audio processors. Three digital audio input ports are available: OPTICAL, COAXIAL and USB DAC, all located on the back panel. The processed analog audio is available from the dedicated stereo (RCA and XLR) and multi-channel terminals.
- A digital audio source device (such as a DVD/CD player, digital TV box, and PC or Mac) can be connected directly to the input port through an Optical, Coaxial or USB cable (not included). Some configuration may be required on the source device to make sure the audio signal is sent out from the correct output terminal. You can then use the **INPUT** button on the OPPO remote to open the **Input Source Menu** and select the desired input port.

NOTE

- The UDP-205 supports up to 2ch/768kHz PCM and DSD512 signals through its USB audio input, and up to 2ch/96kHz PCM, Dolby Digital, DTS and AAC signal through its Optical and Coaxial audio inputs.
- To utilize the USB DAC input from a Windows computer (XP, Vista, Windows 7, 8, 10), a software driver needs to be installed on the computer. The driver is available online at UDP-205 support page on the OPPO Digital website (www.oppodigital.com).
- No software driver is required for Mac computers.
- We recommend using a digital audio cable no longer than 13 feet (4m) to guarantee the optimal bus performance and the correct interface operations.

Connecting to the Internet

The UDP-205 can play audio, video and photos via your home network. This feature supports DLNA, SMB/CIFS and NFS protocols.

The UDP-205 also supports the BD-Live feature offered on some Blu-ray Disc titles. BD-Live offers extra downloadable content and additional online interactive programs. Content available on BD-Live varies by disc and studio, and may include additional subtitles, commentaries, movie trailers, games, and online chat.

Connecting the player to the Internet will also allow the player to obtain firmware updates. (See page 72 for more information regarding firmware updates.)

In order to utilize the BD-Live feature or to update the firmware via the Internet, the player needs to be connected to a broadband Internet connection. It is not necessary to connect to the Internet if you do not intend to use BD-Live or online firmware update features.

The UDP-205 provides two network connection methods: through Ethernet cable or through the built-in wireless module. For the fastest and most stable network connection, we recommend using an Ethernet cable whenever possible.

Internet Connection via Ethernet Cable

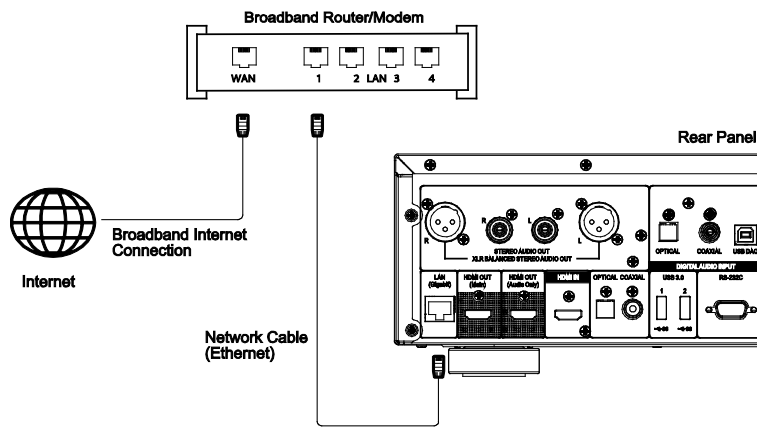

- Plug one end of a network cable (Category 5/5E straight Ethernet cable) into the LAN port on the back of the UDP-205.
- Plug the other end of the network cable into a LAN port on the broadband router or modem.
- After physically connecting the player to a broadband Internet connection, some network configuration may be required. Refer to the **Network Setup** section on page 76 for details.
- Refer to the operating instructions supplied with the broadband router or modem, or contact the Internet service provider for questions related to setting up the router or modem.

NOTE

- Only connect the LAN port of the player to an Ethernet port that supports 1000BASE-T or 100BASE-TX or 10BASE-T. Connecting to any other ports or jacks, such as a phone jack, can damage the player.

Internet Connection via Wi-Fi

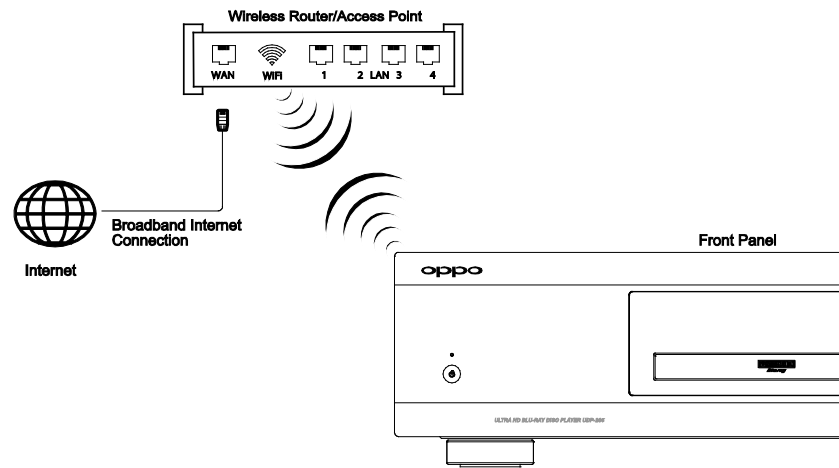

- A built-in wireless module is installed in the UDP-205. The wireless module is compatible with 802.11A, B, G, N (2.4GHz and 5GHz) and 802.11 AC (5GHz) wireless networks.
- Make sure that a broadband Internet connection is available and the Wi-Fi function on your wireless router or access point has been turned on.
- Refer to the **Network Setup** section on page 76 for details.

RS232 Control

The UDP-205 has an RS232 control port and can be integrated into most custom home theater control systems. Details of the RS232 control protocol are listed in the **RS-232 Control Protocol** section on page 85 of this manual.

BASIC OPERATIONS

Disc Playback

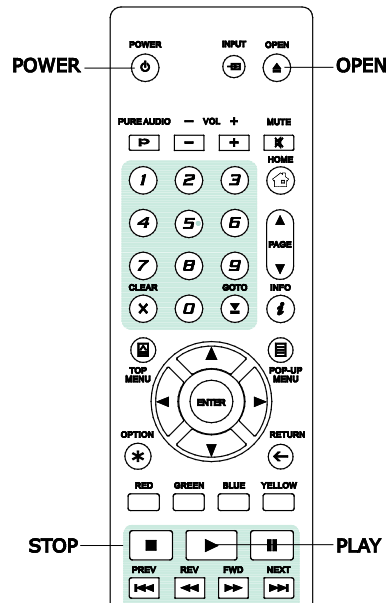

1. Press the **POWER** button to turn on the player.
2. Press the **OPEN/CLOSE** button to eject the disc tray.
3. Place the disc with the label side facing up and the recorded side facing down.

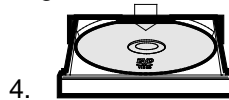

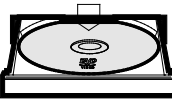
4. 
5. Press the **OPEN/CLOSE** button again to retract the tray.
6. The player will read the disc information and begin playback.
7. Depending on the content of the disc, a menu or navigation screen may appear. Use the navigation **ARROW** and **SELECT** buttons to select the content to play.
8. To stop playback, press the **STOP** button.
9. To turn off the player, press the **POWER** button.

OPTION Menu

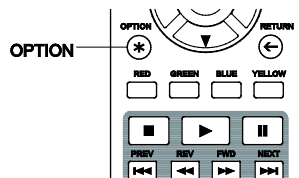

1. During media file navigation and playback, press the **OPTION** button on the remote to open the **OPTION MENU**, which allows you to conveniently access various settings and playback features.
2. When the **OPTION MENU** is displayed, press the **UP/DOWN ARROW** buttons on the remote to highlight a particular item, then press the **ENTER** button to confirm.

The **OPTION MENU** selections may vary depending on the content being played. A summary of the selections and their functionality is described as follows:

During Music File and Music Disc (CD, SACD) Playback:

- Now Playing: Go to the Now Playing interface for the track being played.
- Shuffle/Random: Activate Shuffle or Random playback mode. See details on page 34.
- Repeat: Repeat the current track or all tracks. See details on page 33.
- Add to Favorites: Add the track to the first position in **Favorites**.
- Add to Playlist: Add the track to a Playlist.
- Add All to Playlist: Add all the tracks in the current folder to a Playlist.
- Goto Playlist: View the playlist that the track is playing from.
- Locate: Return to the MUSIC interface and highlight the track that is now playing.
- Program Play: Play the tracks in the preferred sequence (only available with CD playback).
- Gapless Play: Enable Gapless Playback mode. This feature supports APE, WAV, and FLAC files stored on an external USB drive.
- CUE Tracklist: Show the tracklist of the selected CUE file.

During Video Discs (DVD, BD) and Video File Playback:

- Subtitle Adjustment: Set the subtitle display options.
 - Color: Set subtitle text color (only available on external subtitle files).
 - Outline color: Set the outline color for subtitle text (only available on external subtitle files).
 - Size: Set subtitle text size (only available on external subtitle file).
 - Position: Set subtitle display position.
 - Sync: Adjust the timing of the subtitles (only available on external subtitle files).
 - Defaults: Reset all subtitle options to their default values.
- Subtitle Setting: Choose the desired subtitle language from all available subtitles.
- Audio Setting: Choose the desired audio track from all available audio tracks.
- Picture Adjustment: Show the **Picture Adjustment** menu. See details on page 56.
- 3D: Enable 2D->3D conversion or open the **3D adjustment** menu.
- Zoom: Open the image **Zoom Level** menu. See details on page 31.
- Angle: Change the viewing angle. This function is only available when the DVD/BD is recorded with multiple angles.
- Repeat: Repeat a particular Chapter, Title or Disc. See details on page 33.
- Add to Favorites: Add the video file to the first position in **Favorites**.
- A/V Sync: Configure the time offset for audio / video synchronization. See details on page 61.
- PIP (Picture in Picture): Change the display mode to picture in picture mode.
- SAP (Secondary Audio Program): Set the Secondary Audio Program mixing option to mix the Secondary Audio Program and menu sounds into the primary audio. See details on page 59.

During Photo File Playback:

- Zoom: Display the image at different zoom levels.
- Transition: Change slideshow transition effect.
- Rotate – Left / Right / Mirror / Flip: Rotate the image on the screen.
- 3D: Enable 2D->3D conversion or open the 3D adjustment menu.
- Shuffle/Random: Activate Shuffle or Random playback mode.
- Repeat: Repeat the photo or all photos.
- Add to Favorites: Add the photo to the first position in **Favorites**.

Fast Forward and Reverse



You may fast forward or reverse during playback.

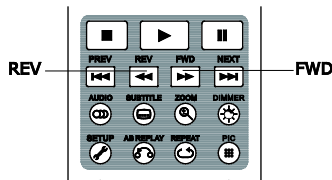

1. Pressing the **FWD** button on the remote control to start fast forwarding playback. Each press of the **FWD** button increases the playback speed in the following increments:



2. Pressing the **REV** button on the remote control starts fast reverse playback. Each press of the **REV** button reverses the playback speed in the following increments:



NOTE

- Certain Blu-ray Discs utilizing BD-Java technology may have their own fast forwarding and reversing control. The actual speed varies by disc, and a progress scale may be displayed by the disc.

Pause and Frame-by-Frame

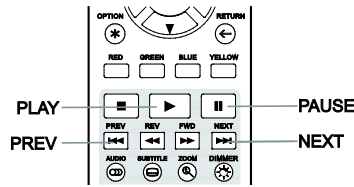

1. During playback, pressing the **PAUSE** button temporarily pauses the program. In this mode, a **PAUSE** icon will appear on the TV screen.
2. While a DVD or Blu-ray Disc is paused, pressing the **PREV** or **NEXT** button reverses or advances the video frame-by-frame.
3. Pressing the **PLAY** button resumes normal playback.

Slow Playback

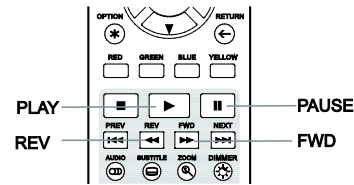

To play the video in slow-motion, follow these steps:

1. Press the **PAUSE** button on the remote control to pause playback.
2. Press the **FWD** button to select a forward slow playback speed. Each press of the **FWD** button increases the playback speed in the following increments:



3. Press the **REV** button to select a reverse slow playback speed. Each press of the **REV** button reverses the playback speed in the following increments:



4. To exit the slow playback mode, press the **PLAY** button.

NOTE

- Certain Blu-ray Discs utilizing BD-Java technology may not support slow playback.
- The player doesn't support reverse video frame-by-frame or slow playback while a 4K UHD Blu-ray Disc is paused.

Blu-ray Disc Menu Navigation

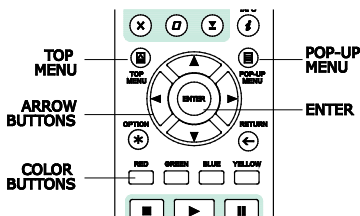

1. Blu-ray Discs usually contain a **Top Menu** and a **Pop-up Menu**. The **Top Menu** normally appears at the beginning of playback, after the previews and copyright messages. The **Pop-up Menu** can be accessed during the movie without interrupting playback.
2. During playback, press the **POP-UP MENU** button to access the **Pop-up Menu**. Press the **TOP MENU** button to access the **Top Menu**.
3. Navigate the menu using the **ARROW** buttons, and then press the **ENTER** button to make a selection.
4. Some menus make use of the **COLOR** buttons. You can select menu functions by pressing the corresponding **COLOR** button on the remote control.

DVD Menu Navigation

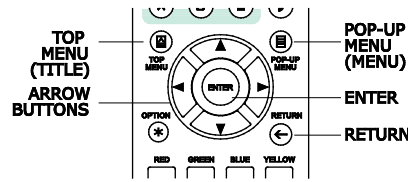

1. Some DVDs contain title menu or chapter menu functions.
2. During playback, press the **TOP MENU** button to return to the disc title menu. Press the **POP-UP MENU** button to display the chapter menu. Depending on the disc, one or both menus may not exist.
3. Navigate the menu using the **ARROW** buttons, and then press the **ENTER** button to make the selection.
4. Press the **RETURN** button to return to the previous menu. The return location varies by disc.

On-Screen Display

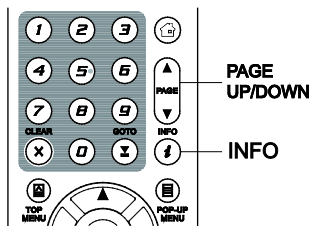

1. During the playback of a DVD or Blu-ray Disc, press the **INFO** button on the remote control to show its media information and HDMI output format. For CDs and SACDs, the status information is shown automatically.
 2. When the status information is shown, press the **PAGE UP/DOWN** buttons to scroll through several different display formats. The playback time information displayed on the front panel changes together with the on-screen display.
3. Press and hold the **INFO** button for 3 seconds to show more detailed Media Playback, Media Information, and HDMI Output information.
 4. Press the **INFO** button again to hide the on-screen display. The playback time information display on the front panel will remain in the selected format.

The following display formats are available:

DVD and Blu-ray Disc:

- | | |
|---------------------------|-----------------------------|
| - Title elapsed time | - Chapter elapsed time |
| - - Title remaining time | - - Chapter remaining time |

CD and SACD:

- | | |
|---------------------------|--------------------------|
| - Track elapsed time | - Disc elapsed time |
| - - Track remaining time | - - Disc remaining time |

In addition to the playback time, the on-screen display may also contain the following information about the content currently playing:

- Playback status: an icon indicating play, pause, and fast forward/reverse status.
- Bit rate meter: an indication of the bit rate of the audio and video stream.
- Current and total title numbers. (DVD and Blu-ray Discs)
- Current and total chapter numbers of the current title. (DVD and Blu-ray Discs)
- Current and total tracks. (CDs and SACDs)
- Video format information: resolution, frame rate, HDR format, color space, codec, original aspect ratio, peak brightness.
- Subtitle information: current and total available number of subtitle tracks and language.
- Audio information: current and total available number of audio tracks, language, format, and channels.
- HDMI output information: video output resolution, frame rate, HDR format, color space, aspect ratio, audio output format, sample rate, bit depth and channels.

Volume Control

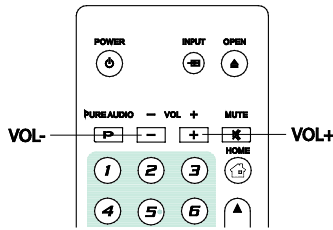

1. On the UDP-205, the volume control only affects the analog audio output. It does not apply to digital audio output (HDMI, Coaxial and Optical) either in raw bitstream format or in LPCM format.
2. The **VOL +/-** buttons on the player's remote control are provided as an alternative way of controlling the audio volume. It is recommended that you use this control to make the audio volume from the player the same as from other sources, such as TV programs or a VCR.
 - Press the **VOL -** button to decrease the volume.
 - Press the **VOL +** button to increase the volume.

Mute

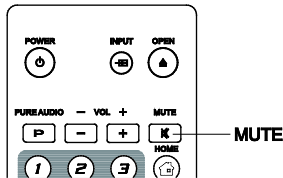

1. Press the **MUTE** button on the remote control during content playback to turn off audio output. The TV screen will display a mute icon. The front panel MUTE indicator will also light up.
2. Press the **MUTE** button again to resume audio output.

NOTE

- Check the MUTE status on the front panel display of the player when there is no audio output. You may also press the **MUTE** button to verify the MUTE status.

Audio Language/Track Selection

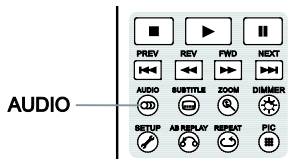
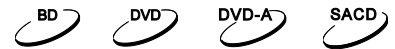

1. To select the audio language or track, press the **AUDIO** button on the remote control during playback.
2. Repeatedly press the **AUDIO** button or use the **UP/DOWN ARROW** buttons to choose from all available language or audio tracks.

NOTE

- Availability of languages and audio channels varies by disc. Some DVD-Audio discs allow audio track selection with the **AUDIO** button, while others require the user to choose from the audio setup menu of the disc. When playing an SACD with both multi-channel and stereo content, the **AUDIO** button can be used to switch between the two formats.

Subtitle Selection

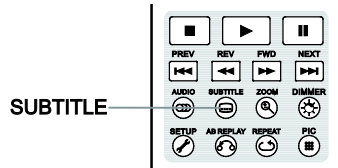

1. When playing a DVD, Blu-ray Disc or other video programs recorded with subtitles, press the **SUBTITLE** button on the remote control to select the desired subtitle.
2. Repeatedly press the **SUBTITLE** button or use the **UP/DOWN ARROW** buttons to choose from all available subtitles.
3. To turn off subtitles, select **Off** from the list.

HDMI INPUT Selection

Input
1. BLU-RAY PLAYER
• 2. HDMI IN
3. ARC: HDMI OUT

1. When sending external media sources to the UDP-205 through the HDMI IN port, press the **INPUT** button on the remote to open the **Input Source** menu.
2. Use the **UP/DOWN ARROW** buttons to choose the HDMI IN port.
3. You can always select the **BLU-RAY PLAYER** to return to OPPO HOME Menu.

Digital Audio Input Selection

Input
1. BLU-RAY PLAYER
• 2. HDMI IN
3. ARC: HDMI OUT
4. OPTICAL IN
5. COAXIAL IN
6. USB AUDIO IN

1. When sending external digital audio sources to the UDP-205 through the OPTICAL, COAXIAL and USB DAC ports, press the **INPUT** button on the remote to bring the "Input Source" menu.
2. Use the **UP/DOWN ARROW** buttons to choose the required HDMI input port.
3. You can always select the **BLU-RAY PLAYER** to return to OPPO HOME menu.

Audio Return Channel (ARC) Selection

Input
1. BLU-RAY PLAYER
2. HDMI IN
• 3. ARC: HDMI OUT

1. When sending a digital audio signal from the TV back to the UDP-205 through an HDMI connection, press the **INPUT** button on the remote to bring the **Input Source** menu.
2. Use the **UP/DOWN ARROW** buttons to choose the ARC channel.
3. You can always select **BLU-RAY PLAYER** to return to OPPO HOME Menu.

NOTE

- Audio Return Channel (ARC) is a feature introduced in HDMI v1.4, which allows you to send digital audio signals from the television back to the player or receiver. Instead of listening through TV speakers, ARC allows the sound to be processed and produced by the home theater audio system.
- An HDMI 1.4 cable is required and you need to make sure the HDMI input port on the TV is ARC capable. Usually, ARC has to be enabled in the TV's settings.

BD-Live



 Some Blu-ray Disc titles are released with the BD-Live feature. BD-Live offers extra downloadable content and additional online interactive programs. BD-Live content varies by disc and studio, and may include additional subtitles, commentaries, preview trailers, games, and online chat. A Broadband internet connection is required to enjoy BD-Live content.

Depending on how the studios organize their BD-Live content, some Blu-ray Discs may start downloading BD-Live content when playback starts, have a BD-Live selection on the main menu, show a prompt asking whether you would like to start downloading, or ask you to sign up for a membership or account. Please follow the instructions that come with the disc to enjoy BD-Live contents.

Your Internet connection speed and the capacity of the BD-Live content servers can all affect how fast BD-Live content is downloaded. If you encounter slow downloading or intermittent playback, please play the disc without accessing the BD-Live features, or try again at a different time.

When you use the BD-Live feature, the player or disc ID and your IP (Internet Protocol) address may be sent to the content provider via the Internet. Generally, no personally identifiable information is sent. However technologies exist to match your IP address to a certain geographical area or service provider. Your Internet service provider also has the knowledge of who is using a particular IP address. If the BD-Live content provider requires you to log in using a membership or account, the content provider will have access to your membership or account information. Check with your Internet service provider and the BD-Live content providers for their privacy policy.

You can choose to restrict BD-Live Network Access in the Setup Menu (details on page 79).

ADVANCED OPERATIONS

Zooming and Aspect Ratio Control

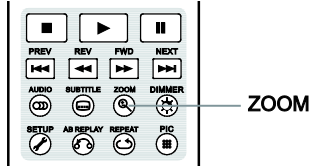

This feature zooms in and out of the displayed frame and also changes the aspect ratio (image width vs. height).

To change the zoom level, press the **ZOOM** button on the remote control. Each press of the **ZOOM** button will switch the zoom level in sequence.

Zoom Levels for HDMI Output

The available zoom levels depend on the **TV Aspect Ratio** setting in the **Setup Menu** and the encoded aspect ratio on the BD/DVD Disc:

1:1 (No zoom), Stretch/Compress, Full Screen, Under Scan, 1.2X, 1.3X, 1.5X, 2X, 1/2X

The zoom level is reset to 1:1 when the disc is ejected, or when the player is turned off.

The following zoom levels may be useful for specific applications:

- 1) Playing 16:9 BD or DVD when **TV Aspect Ratio** is set to **16:9 Wide** or **16:9 Wide/Auto**
 - **Stretch** – The image is vertically stretched 1.33 times. For movies with 2.35:1 aspect ratio, this zoom level cuts off the black borders at the top and bottom of the image. Users of a projector with an anamorphic lens may find this mode helpful.

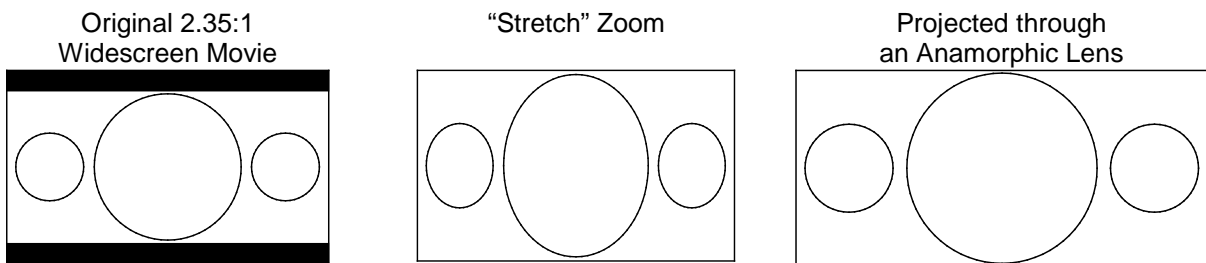

- **Full Screen** – The image is stretched by 1.33 times for both vertical and horizontal directions. For movies with 2.35:1 aspect ratio, this zoom level cuts off the black borders at the top and bottom of the image while maintaining the correct aspect ratio. The left/right sides of the image are slightly cropped.

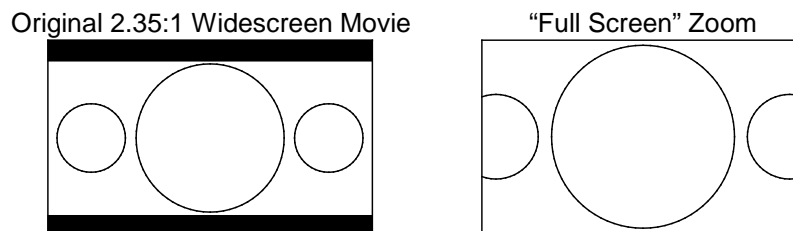

2) Playing 4:3 BD or DVD when **TV Aspect Ratio** is set to **16:9 Wide**

- **1:1** – The image fills up the entire 16:9 screen but is horizontally stretched. Figures may look shorter and wider than they should be.
- **Compress** – The player maintains the correct 4:3 aspect ratio and adds borders to the left and right sides of the image.
- **Full Screen** – This zoom level maintains the correct aspect ratio but crops the top and bottom slightly in order to fit the 4:3 image to the 16:9 screen.

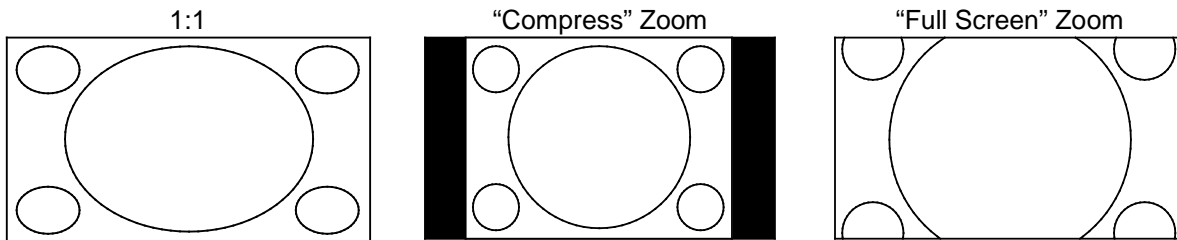

3) Playing 4:3 BD or DVD when **TV Aspect Ratio** is set to **16:9 Wide/Auto**

- **1:1** – The player maintains the correct 4:3 aspect ratio and adds borders to the left and right sides of the image.
- **Stretch** – The image is horizontally stretched 1.33 times. This zoom level fills up the 16:9 screen, but figures may look shorter and wider than they should be.
- **Full Screen** – This zoom level maintains the correct aspect ratio but crops the top and bottom slightly in order to fit the 4:3 image to the 16:9 screen.

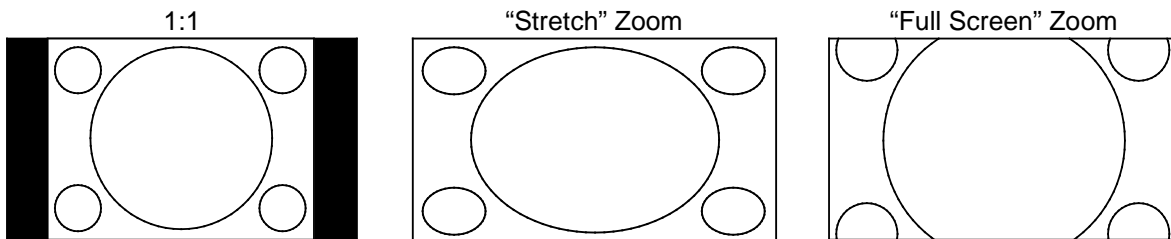

The “Under Scan” zoom level shrinks the image by 5%. This zoom level may be used to compensate for TVs that over scan, so the viewer can see the entire image area with no cropping. All other zoom levels are indicated by their respective zoom ratio.

NOTE

- Some early DVD titles (released from 1997 until early 2000’s) use a 4:3 non-anamorphic widescreen aspect ratio. When played on a 16:9 display, the content is shown in a small window with black borders on all four sides. The top and bottom borders are encoded into the video. The left and right borders are added by the player to maintain the correct aspect ratio. For these types of discs, the **Full Screen** zoom mode can be used to eliminate the borders.
- The ZOOM feature may not be available when certain DVD or Blu-ray Discs are played if the disc’s author has chosen to disable ZOOM.

Subtitle Shift

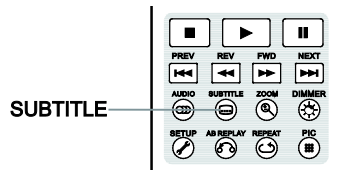

For customers using a 2.35:1 “Constant Image Height” video projection system, subtitles may get cut off because they are positioned outside of the active video area.

The Subtitle Shift feature can be used to shift subtitles up or down so they are displayed within the active video area.

To shift the display position of subtitles, please follow these steps:

1. When playing a DVD, Blu-ray Disc or other video programs recorded with subtitles, select the desired subtitle from the disc menu or by using the remote. (Refer to page 29 for more information.)
2. Press and hold the **SUBTITLE** button on the remote control until the **Shift Subtitle Position** prompt appears on the screen.
3. Wait until subtitle text is shown on the screen, and then use the **UP/DOWN ARROW** buttons to move the subtitle text to the desired position.
4. Press the **ENTER** button to set the subtitle display position.

Once the **Subtitle Shift** position is set, it is saved by the player in the **Playback Setup > Subtitle Shift** setup menu option. The setting will be applied to subtitles of all future DVD and Blu-ray Discs. You can also change the setup menu item directly.

Repeat Playback

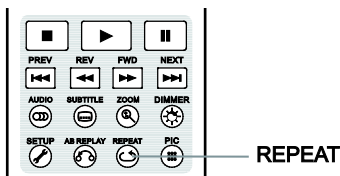

To repeat a certain chapter, title, track or disc, press the **REPEAT** button on the remote control.

Each press of the **REPEAT** button changes the repeat mode using the following sequence:

DVD and DVD-Audio:



Blu-ray Disc:



CD and SACD:



NOTE

- Certain Blu-ray Discs may not allow for repeating.

Repeat a Selected Section

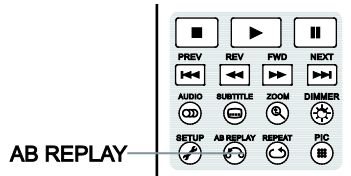

To repeatedly play a specific section, please follow these steps:

1. During normal playback, press the **AB REPLAY** button on the remote at the desired beginning point (Point A) for the repeat play. The TV screen displays "A-".
2. When playback reaches the desired ending point (Point B) for the repeat play, press the **AB REPLAY** button again. The player now repeatedly plays back the specified section (A-B). The TV screen displays "A-B".
3. Press the **AB REPLAY** button for the third time to resume normal playback.

NOTE

- Not available for all disc formats or content. Certain Blu-ray Discs may not allow for repeating.
- If pressing the AB REPLAY button twice within 1 second, video playback will be automatically rewind 10 seconds.

Shuffle and Random Playback

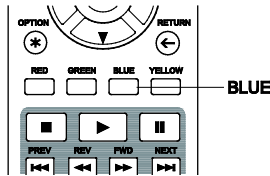

When playing a CD or SACD, press the **BLUE** button on the remote control to activate the **Shuffle** and **Random** modes. Each press of the **BLUE** button switches the playback mode in the following sequence:



In normal playback mode, each track is played back in sequential order. As the name implies, the **Random** playback mode randomly selects a track to play. The **Shuffle** mode also plays back the tracks in random order, but it ensures that each track is played only once.

Selecting the **Shuffle** or **Random** mode cancels any **Repeat** mode you may be using. Similarly, selecting a **Repeat** mode cancels any **Shuffle** or **Random** mode.

Playback by Chapter or Track Number

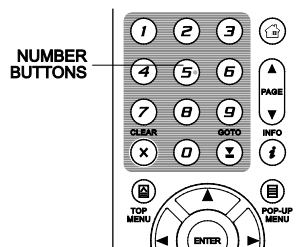

During the playback of a disc, you can use the **NUMBER** buttons on the remote control to directly jump to a specified chapter or track number. For example:

- To select the seventh track, press the **[7]** button.



- To select the 16th track, press **[1]** followed by **[6]** in quick succession:

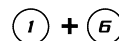

NOTE

- Certain DVD-Audio and Blu-ray Discs may not allow for direct chapter selection.

Playback from a Specific Location



DVD and Blu-ray Discs

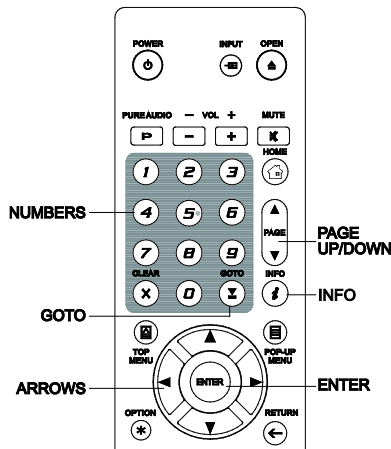

During the playback of a DVD or Blu-ray Disc, you may specify a location to start playback by entering the title, chapter or time directly. Press the **GOTO** button to bring up the on-screen display.

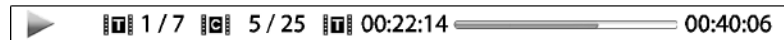

On top of the video screen, the on-screen display information has the following components (from left to right): Playing Status, Title, Chapter, Time Counter, Progress Indicator, and Total Time. After pressing the **GOTO** button for the first time, the cursor will be positioned at the Time Counter. This is the **Time Search** mode. Each subsequent press of the **GOTO** button will switch the search mode in the following sequence:



1. **Title time search.** Searches for a specific time within the currently playing title.

- Press the **GOTO** button to bring up the on-screen display. The cursor will be positioned at the Time Counter. Use the **NUMBER** or **ARROW** buttons to enter the hours, minutes and seconds for your specific search and press the **ENTER** button.

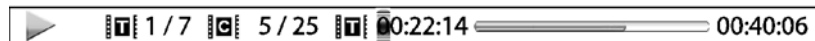

2. **Chapter time search.** Searches for a specific time within the currently playing chapter.

- Press the **INFO** button to bring up the on-screen display. Use the **PAGE UP** or **PAGE DOWN** button to switch the display to Chapter Time mode (note the icon placed on the left of the Time Counter changes from the Title icon to the Chapter icon). Press the **GOTO** button to position the cursor at the Time Counter, then use the **NUMBER** or **ARROW** buttons to enter the hours, minutes and seconds for your specified search and press the **ENTER** button.



3. **Chapter search.** Allows you to search for a particular chapter.

- Repeatedly press the **GOTO** button until the cursor is positioned at the Chapter location. Use the **NUMBER** or **ARROW** buttons to enter or select the chapter number and press the **ENTER** button.

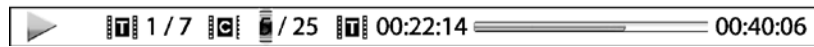

4. **Title search.** Allows you to search for a particular title.

- Repeatedly press the **GOTO** button until the cursor is positioned at the Title location. Use the **NUMBER** or **ARROW** buttons to enter or select the title number and press the **ENTER** button.

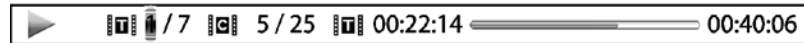

NOTE

- Some discs may prohibit the search operation. You will not be able to select a search location, or you may get an “invalid operation” icon after specifying a search location.
- Some Blu-ray Discs feature their own search function. Follow the on-screen instructions to use the search function provided by such discs.

CD and SACD discs

You may specify a point to start playback by entering the disc elapsed time, track elapsed time or track number directly. When playing CDs and SACDs, the on-screen display automatically shows on the TV screen:

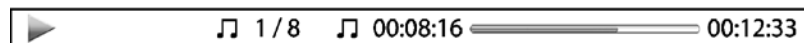

The on-screen display has the following components (from left to right): Playing Status, Track Number, Time Counter, Progress Indicator, and Total Time.

To specify a playback location using one of the following search modes, press the **GOTO** button. Each press of the **GOTO** button switches the search mode in the following sequence:



1. **Track time search.** Searches for a specific time within the currently playing track.

- Press the **GOTO** button to place the cursor on the track Time Counter. Use the **NUMBER** or **ARROW** buttons to enter the hours, minutes and seconds for your specified search and press the **ENTER** button.

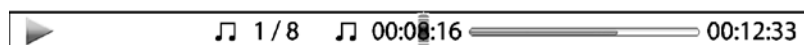

2. **Disc time search.** Navigates you to a particular timestamp.

- While the on-screen display is shown, press the **PAGE UP** or **PAGE DOWN** button to switch the Time Counter to Disc Time mode. Press the **GOTO** button to place the cursor at the Disc Time Counter. Use the **NUMBER** or **ARROW** buttons to enter the hours, minutes and seconds for your specified search and press the **ENTER** button.

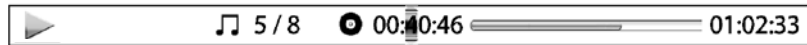

3. **Select a track.** To navigate to a particular track:

- Repeatedly press the **GOTO** button until the cursor is placed on the Track Number position. Use the **NUMBER** or **ARROW** buttons to enter or select the track number and press the **ENTER** button.

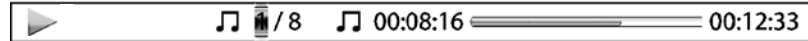

Memory and Automatic Resume

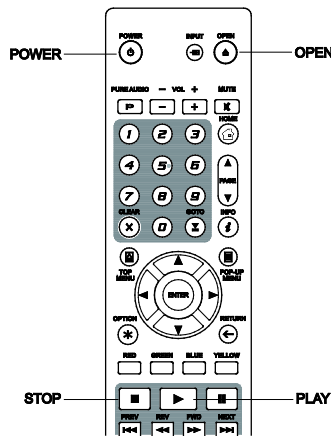

1. The player automatically saves the current position when playback is interrupted. Operations such as **STOP**, **OPEN**, and **POWER** cause the player to save the current playing position.
2. This position is saved even after turning off the unit or changing the disc.
3. The next time a disc with a saved playing position is inserted, the player will resume playback from that point. If you wish to cancel the automatic resume and start playback from the beginning, you must press the **STOP** button when prompted.
4. The player can save the playback position for up to 5 discs. When the position from the sixth disc is saved, the oldest saved position is replaced.

NOTE

- Some Blu-ray Discs do not support resuming and will always play from the beginning.

Viewing Pictures on DVD-Audio Discs

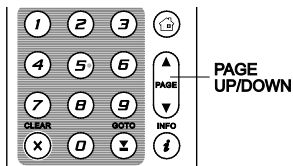

Some DVD-Audio discs contain static pictures, such as photos of the band as well as album narration. When a DVD-Audio track is playing, you may use the **PAGE UP** button to select the previous picture or the **PAGE DOWN** button to select the next picture.

NOTE

- Availability of static pictures depends on the DVD-Audio disc.

Pure Audio Mode

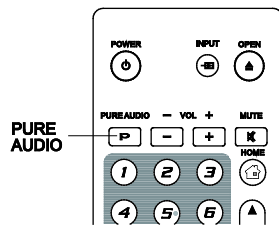

The **Pure Audio** mode reduces any potential interference between the video and audio signals by turning off the player's video processing and output.

1. Press the **PURE AUDIO** button on the remote control to turn off video and enter **Pure Audio** mode. Video output will cease, the power light will dim and the front panel displays will turn off.
2. Press the **PURE AUDIO** button again to resume video and cancel **Pure Audio** mode.

NOTE

- **Pure Audio** mode is automatically canceled when the unit is switched off or when playback is stopped.
- Because HDMI carries audio together with video, the HDMI video signal cannot be completely turned off. A black screen is transmitted instead to minimize any potential interference.

MEDIA FILE PLAYBACK

In addition to playing standard disc-based formats such as Blu-ray, DVD, CD and SACD, the UDP-205 can play digital media files. You can enjoy digital music, movies and photos stored on a data disc (recordable CD, DVD or Blu-ray), an external USB drive, or via network storage. Due to the variation of media, encoding software and techniques used, compatibility cannot be guaranteed for all user-created or downloaded content. Support for such content is on a best effort basis.

Playback from a USB Flash Drive

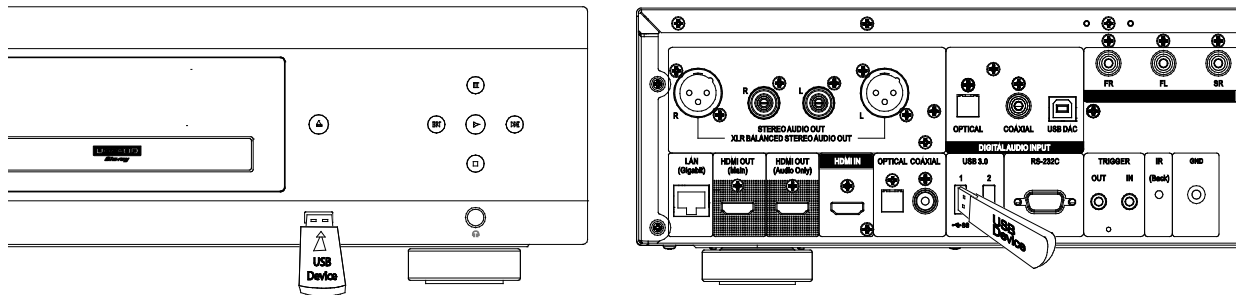

The UDP-205 is equipped with three USB ports: two USB 3.0 ports in the back and one USB 2.0 port in the front. You may use any of the available USB ports to plug in a USB drive.

The USB ports are rated to provide a maximum of 5V, 1000mA power to the USB drive. It is sufficient for USB thumb drives and flash memory card readers, but may not be sufficient for USB hard disks. It is recommended to check with your drive manufacturer for power requirements, or use an external power supply.

NOTE

- This unit supports “USB Mass Storage Class Bulk-Only Transport” devices only. Most USB thumb drives, portable hard disk drives and card readers conform to this device class. Other USB devices such as MP3 players, digital cameras, and mobile phones may not be compatible.
- Supported USB drives can be formatted with the FAT (File Allocation Table), FAT32, exFAT or NTFS (New Technology File System) file systems.
- In some cases, an incompatible USB device may cause the player to stop responding. If this occurs, simply turn off the power, remove the USB device, and turn the player back on.
- In order to minimize the risk of data corruption, it is recommended that you only unplug the USB device when playback is completely stopped.

Playback from a Home Network

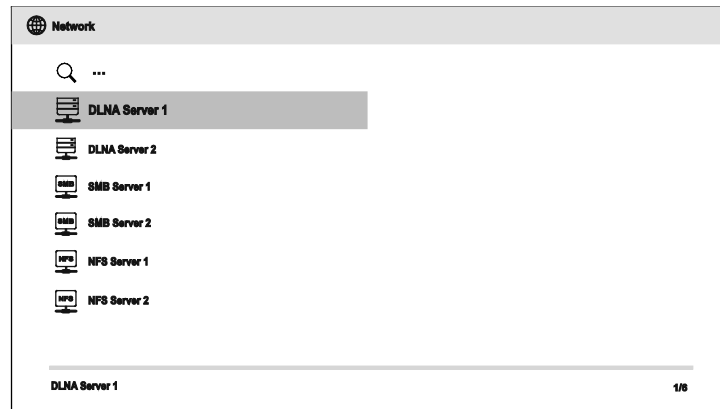

The UDP-205 can remotely play back music, photo, and video files stored on computers or NAS (Network Attached Storage) devices that are connected to the same home network. The computer or NAS need to run server software that supports media sharing protocols such as DLNA, SMB/CIFS or NFS. To play media files shared on your home network, press the **HOME** button on the remote to bring the **Home Menu**, select the **Network** icon and press the **ENTER** button to show the list of available servers.

The UDP-205 player can play media files on the home network in one of the following three ways:

- As a digital media player (DMP): the player can actively search, access and pull content from local media servers which supports DLNA.
- As a digital media renderer (DMR): the player plays content received (“pushed”) from a digital media controller (DMC). A DMC-capable media server is required. Refer to the server’s respective user instructions for correct configuration and operation.
- As a SMB/CIFS/NFS client: the player can directly access files shared through SMB/CIFS/NFS servers over the network, as if accessing an external USB hard drive. Most computers, especially those installed with Windows, already support SMB clients. Please refer to respective OS instructions to set up the SMB/CIFS/NFS shared file/folder.

NOTE

- NAS is a networked appliance that provides file-based data storage services to other devices on the network. Commercial products are available on the market.
- SMB (Server Message Block) or CIFS (Common Internet File System) is mostly known as Microsoft Windows Network. It does not require an extra media server or perform any media format transcoding, which reduces the processing load and keeps the original content quality.

HOME Menu

The UDP-205 presents a **Home Menu** to assist you in navigating and playing media files from an inserted optical disc, USB flash drive, external hard drive, home network sharing. Basically, the **Home Menu** is the starting point for accessing media files.

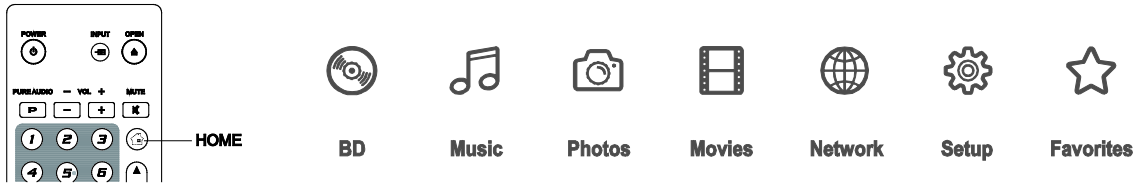

You can bring up the **Home Menu** with the **HOME** button on the remote control. Currently there are seven selections:

- **Disc** enables the player to start playback of an inserted optical disc.
- **Music, Movies** and **Photos** allow you to access corresponding type of media files from a connected USB drive and inserted data disc.
- **Network** enables the player to stream audio, video and photos from media servers on the home network. Compatible hardware and software may be required.
- **Setup** brings the player's **Setup Menu**, just like pressing the **SETUP** button on the remote.
- **Favorites** provides you with a shortcut to access folders or files you love or often access.

Playing Music Files

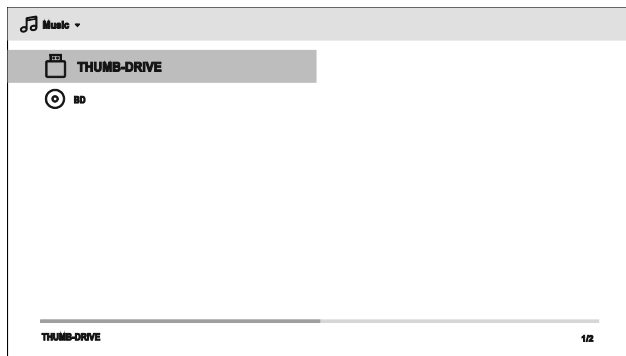

To play digital music files stored on an optical disc or USB drive, select **Music** from the **Home Menu**. A file browser will appear to assist you in navigating the files and folders.

The first step is to select the Data Disc or USB device that contains the music files. The player will take a moment to read the media and list the folders and music files.

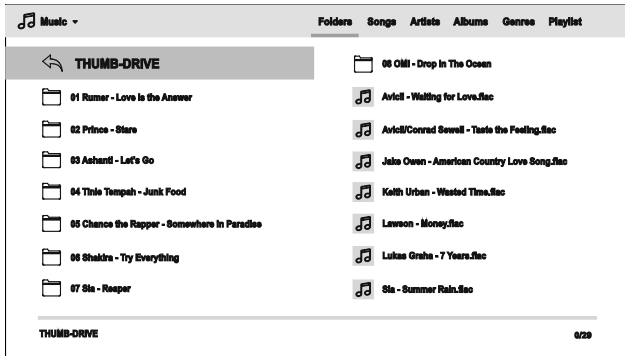

In the music browser, you can perform the following operations:

- Press the **UP/DOWN/LEFT/RIGHT ARROW** or **PAGE UP/DOWN** buttons to move the cursor and select music files.
- Press the **OPTION** button to access features such as adding to a playlist and gapless play. Details can be found on page 24.

- Press the **TOP MENU** button to move the cursor directly to the Category Menu at the top of the screen. The Category Menu contains the following choices:
 - **Media Type Filter**– Allows you to easily access the movie or photo files in the same folder by selecting Movies or Photos in the Media Type Filter at the top left corner of the screen.
 - **Sort** – Sort and display the music files and folders according to the selected category at the top right corner of the screen. The categories include Folders, Songs, Artists, Albums, Genres, and Playlists.
- When a music file is highlighted by the cursor, press the **ENTER** or **PLAY** button to start playback.

NOTE

- When a data disc or USB drive is inserted, the player automatically starts to index files and build a database in the background. Depending on the number and size of files, this process could take up to several minutes. Customers can only access the Category list (Artist, Album and Genre) when the database has been built, otherwise, a warning message will appear.

If a music file starts playing and there is no other user operation, the **Now Playing** screen will appear after a few seconds. You can also get to this screen by pressing the **OPTION** button and then selecting **Now Playing**. This screen provides the following information:

- Shows playback status: Play, Stop, Pause, Track and Time.
- Display and change playback mode: Shuffle/Random, Repeat One/All.
- Music information: Displays information like album art and tags embedded in the music file.



The following operations are available while the **Now Playing** screen is shown:

- Normal playback control: **PLAY**, **STOP**, **PAUSE**, **PREV/NEXT**, **REV**, and **FWD**
- Special playback modes: **REPEAT** and Shuffle/Random (**BLUE** color button)
- Press the **OPTION** button to access the Option menu. (More details on page 24)
- Return to the Browser without stopping the music: **RETURN**
- Stop playback and return to the Browser: Press **STOP**.
- Press the **INFO** button to show detail media information.

Playing Movie Files

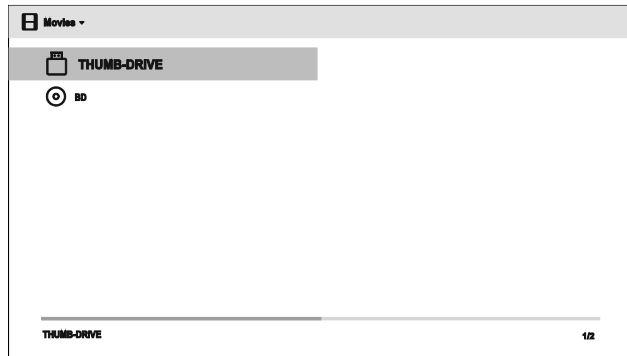

To play movie files stored on an optical disc or USB drive, select **Movies** from the **Home Menu**. A file browser will appear to assist you in navigating through the files and folders.

The first step is to select the Data Disc or USB device that contains the movie files. The player will take a moment to read the media and list the folders and movie files.

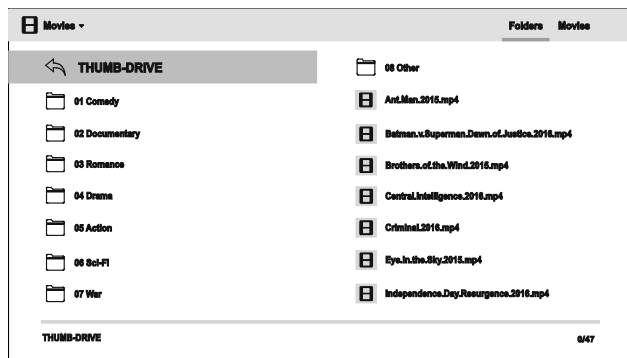

In the movie browser, you can perform the following operations:

- Press the **UP/DOWN/LEFT/RIGHT ARROW** or **PAGE UP/DOWN** buttons to move the cursor and select movie files.
- Press the **TOP MENU** button to move the cursor to the category menu in the top of the screen. This menu functions the same as the one discussed in **Playing Music Files** on page 41.

- When a movie file is highlighted by the cursor, press the **ENTER** or **PLAY** buttons to start playback.

Once a movie file starts playing, the normal playback control functions are available:

- To stop the movie and return to the file browser, press the **STOP** button. You can also press the **HOME** button at any time to stop the playback and return to the Home Menu.
- Press the **OPTION** button to access features such as Subtitle Shift, 3D and Picture Zooming. Details can be found on page 24.

Viewing Photo Files

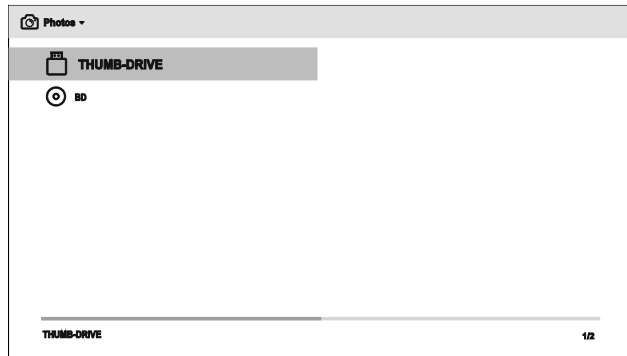

To view digital photo files stored on an optical disc or USB drive, select **Photos** from the **Home Menu**. A file browser will appear to assist you in navigating the files and folders.

The first step is to select the Data Disc or USB device that contains the photo files. The player will take a moment to read the media and list the folders and photo files.

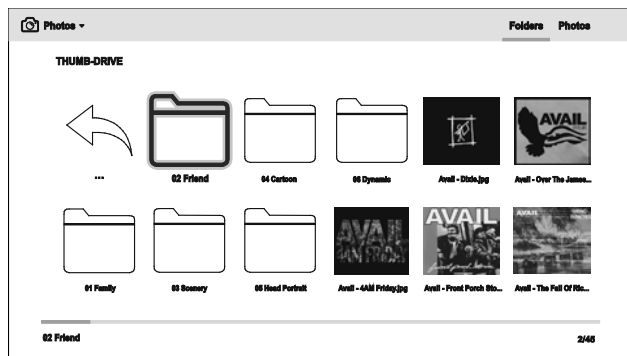

In the photo browser, you can perform the following operations:

- Press the **UP/DOWN/LEFT/RIGHT ARROW** or **PAGE UP/DOWN** buttons to move the cursor and select photo files.
- Press the **TOP MENU** button to move the cursor to the category menu in the top of the screen.

- When a photo file is highlighted by the cursor, press the **ENTER** or **PLAY** button to play back the photos as a full screen slideshow.

The following operations are available during the photo slideshow:

- Show EXIF Information: **GREEN** color button
- Normal playback controls: **PLAY**, **STOP**, **PAUSE**, and **PREV/NEXT**
- Adjust slideshow speed: **REV** and **FWD**
- Zoom: **ZOOM**. Once zoomed in, the **ARROW** buttons can be used to pan around the photo.
- Reflect (flips the photo horizontally to make it upside-down): **UP ARROW**
- Mirror (flips the photo vertically to make it a mirror image): **DOWN ARROW**
- Rotate left (counterclockwise): **LEFT ARROW**
- Rotate right (clockwise): **RIGHT ARROW**
- Repeat: **REPEAT**
- Play in random sequence: **BLUE** color button
- Change slideshow transition effect: **YELLOW** color button.
- Press the **OPTION** button to access to features like Image Zooming and Image Rotation. Details can be found on page 24.

Adding Background Music

You can also add background music to the photo slideshow. To do so, you will need to prepare digital music files. The music files can be stored on the same disk as the photos, or on a different USB drive. Start music playback first by selecting **Music** from the **Home Menu**. Once the music is playing, press the **HOME** button to get back to the **Home Menu**, and start the photo slideshow by selecting **Photo** in the usual manner.

SETUP MENU OPTIONS

The **Setup Menu** of the UDP-205 presents many setup and configuration options. For most users, the default configuration will be sufficient and you will not require any changes to the settings. However, if you need to configure the player to perfectly match your home theater setup and viewing preferences, please refer to the following sections for details about each configuration option.

Using the Setup Menu System

Like many other sections listed in this guide, the player's **Setup Menu** allows you to make adjustments to match your specific audio/video configuration. When performing menu adjustments, we will use the following terminology to indicate the location of the desired function:

Setup Menu Section > Menu Item > Selection

Setup Menu Section is the uppermost **Setup Menu** level. Within the UDP-205, there are six **Setup Menu** sections listed in the left column of the **Setup Menu**: **Playback Setup**, **Video Output Setup**, **Audio Output Setup**, **Audio Processing**, **Device Setup**, and **Network Setup**.

Menu Item is the parameter to be adjusted which appears in the center column of the **Setup Menu**. Once you enter a **Setup Menu Section**, the list of **Menu Items** and their current value are displayed in a box.

Selection is the actual numeric or descriptive element that represents the change being made to the selected parameter. It is the item located to the right of its corresponding **Menu Item**.

A **Scroll Mark** appears at the top or bottom of the menu when there are more **Menu Items** or **Selections** than what can fit in a screen. You may use the **UP** and **DOWN ARROW** buttons to scroll the display in order to access additional items.

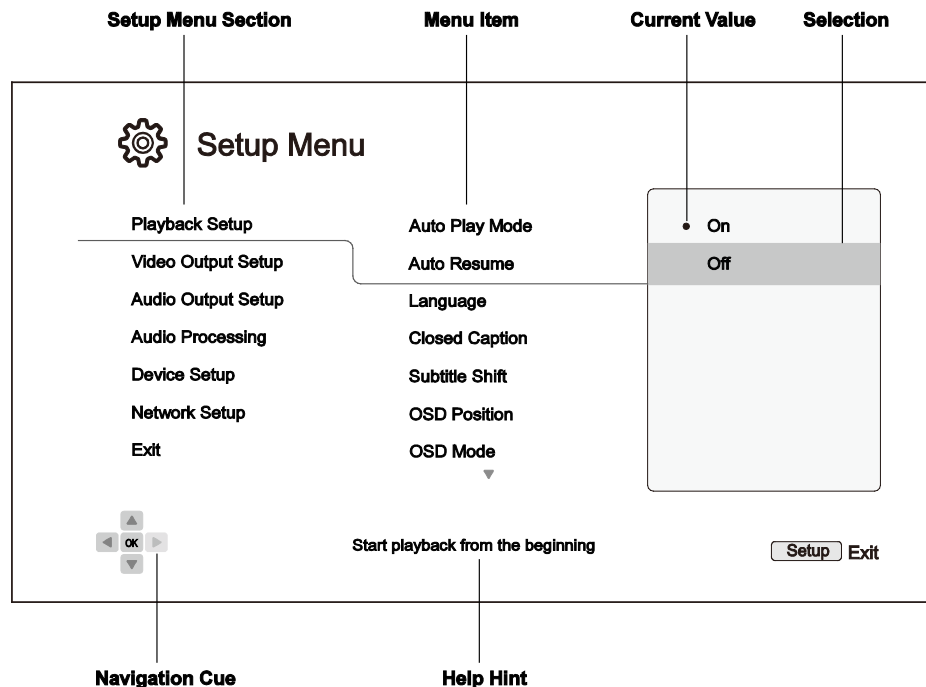

The preceding diagram should give a good description of the various elements and their context. In this screen we could, for example, instruct you to set the **Auto Resume** parameter to **Off** in the **Playback Setup** section. To indicate where we were, you would see the following: **Playback Setup>Auto Resume>Off**.

NOTE

- It is possible that some setup items may be grayed-out and inaccessible. This may be caused by several reasons: playback is ongoing; a disc is in the tray; or a prerequisite setup item excludes some options. Please stop playback and eject the disc before trying to change these setup items. If you still cannot access the setup item, please check for configuration conflicts. For example, if **Network Setup > Internet Connection** is set to **Ethernet**, the **Wireless Setting** menu item will be grayed-out. Setting **Internet Connection** to **Wireless** will enable the **Wireless Setting** menu.

The **Setup Menu** can be accessed by pressing the **SETUP** button on the remote control, or by selecting the “Setup” icon from the Home Menu screen. The following steps are an example of setting **Playback Setup>Auto Resume** to **Off**.

1. Press the **SETUP** button on the remote control, and the TV screen displays the following:

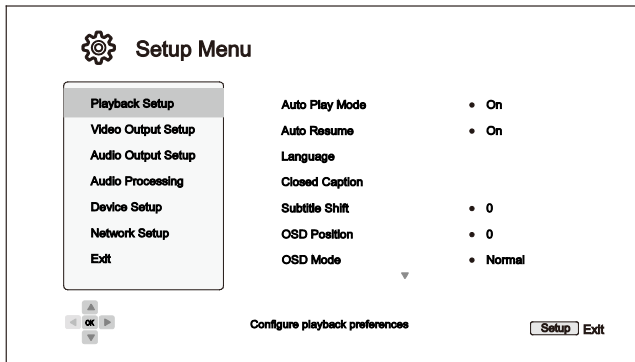

2. Press the **UP/DOWN ARROW** buttons to select the section. Press the **ENTER** button or the **RIGHT ARROW** button to enter the selected section.
3. Press the **UP/DOWN ARROW** buttons to select the setup item to be changed, and press the **ENTER** or **RIGHT ARROW** button to change the setting. When the scroll icon is shown at the top or bottom of the **Setup Menu**, it indicates that there are more menu items that can be accessed by scrolling with the **UP/DOWN ARROW** buttons.

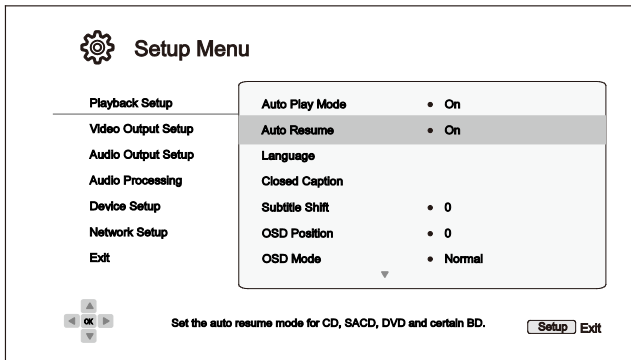

For example, in the **Playback Setup** section, you may use the **UP/DOWN ARROW** buttons to select the **Auto Resume** setup item, and press the **ENTER** button to change the **Auto Resume** setting.

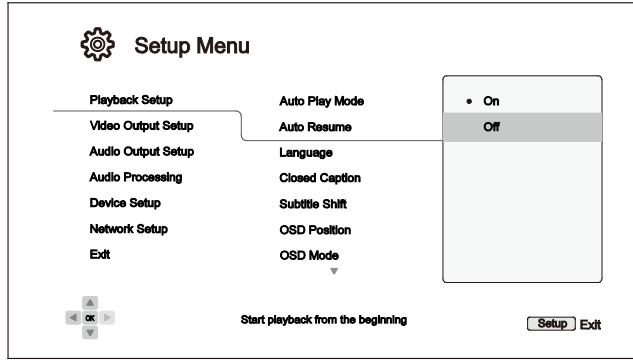

4. To select a value from the list of available settings, press the **UP/DOWN ARROW** buttons and then press the **ENTER** button to confirm.

For example, to select **Off** for **Auto Resume**, use the **UP/DOWN ARROW** buttons to highlight the **Off** selection and press the **ENTER** button.

5. To exit the **Setup Menu** at any time, press the **SETUP** button on the remote control or select **Exit** from the **Setup Menu** sections.

Settings are permanently saved when the player is turned off using either the front panel power button or the remote control. If the AC power is interrupted before the player enters standby, the settings will not be saved. To ensure that the settings are saved, please turn off the player and turn it back on after you make major changes to the **Setup Menu** options.

Playback Setup

The **Playback Setup** section is designed to configure playback preferences. The setup items in this section are:

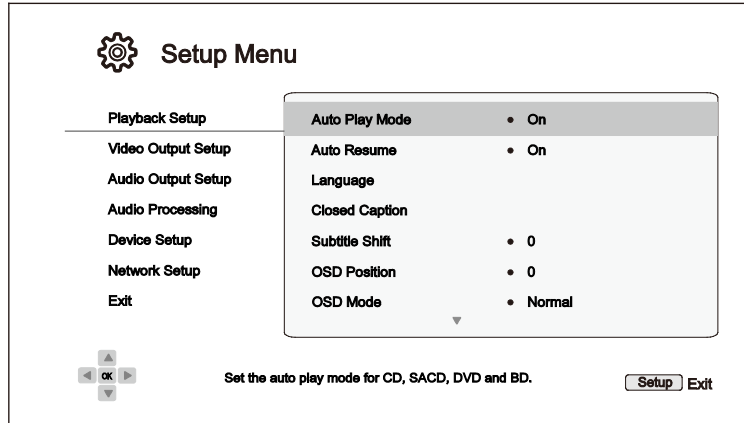

1. **Auto Play Mode:** Select whether the player will start playing a CD, SACD, DVD or Blu-ray disc automatically.
 - **On** (default) – The disc starts playing upon insertion into the player.
 - **Off** – The player waits for the user to start playback by pressing the **PLAY** button.

2. **Auto Resume:** Select whether disc playback will start from the previously saved point or not. This setting applies to CDs, SACDs, DVDs and certain Blu-ray Discs.
 - **On** (default) – Playback automatically starts from the previously saved point.
 - **Off** – Playback starts from the beginning.

3. **Language:** Configures language preferences. This menu contains the following sub-items:
 - **Player Language** – Allows you to choose the language for the player's **Setup Menu** and the on-screen display. Currently the player supports 12 languages.
 - **Disc Menu Language** – Allows you to choose the preferred language for displaying DVD and Blu-ray Disc menus. If a disc menu of the selected language is available, that menu will be shown instead of the default disc menu.
 - **Audio Language** – Allows you to choose the preferred audio language for DVD and Blu-ray Discs. If an audio track of the selected language is available on the disc, the audio track will be played back.
 - **Subtitle Language** – Allows you to choose the preferred subtitle language for DVDs and Blu-ray Discs. If a subtitle of the selected language is available, it will be displayed. When **Auto** is selected, the subtitle display is determined by the disc.

NOTE

- If your preferred language is not listed in the Audio, Subtitle or Disc Menu options, select "Other" and enter the Language Code found on page 84 of this manual.

4. Closed Caption: Configure Closed Caption features.

- **CC Display** – Turn on or off Closed Caption display.
- **CC Select** – Select the data channel for Closed Caption display. Available data channels depend on the content being played.
- **CC Attribute** – Set the Closed Caption attribute. When **CC Attribute** is set to **Custom** you may configure the Closed Caption display attributes listed below.
- **Font Color** – Set the font color for Closed Caption.
- **Font Size** – Set the font size for Closed Caption.
- **Font Style** – Set the font style for Closed Caption.
- **Font Opacity** – Set the font opacity for Closed Caption.
- **Font Edge** – Set the font edge effect for Closed Caption.
- **Font Edge Color** – Set the font edge color for Closed Caption.
- **BG Color** – Set the background color for Closed Caption.
- **BG Opacity** – Set the background opacity for Closed Caption.
- **Window Color** – Set the Closed Caption window color.
- **Window Opacity** – Set the Closed Caption window opacity.

5. Subtitle Shift: Sets the display position for subtitles.

When the **Subtitle Shift** is set at 0 (default), subtitles are displayed at the original position as specified on the disc. When it is set at a value between 1 and 10, subtitles are shifted up. When it is set at a value between -1 and -10, subtitles are shifted down.

This feature is helpful for customers using a 2.35:1 “Constant Image Height” video projection system. Subtitles can be shifted to the active video area so they do not get cut off. You can also press and hold the **SUBTITLE** button for 3 seconds to activate this selection.

6. OSD Position: Allows you to set the display position for the on-screen display (OSD).

When the **OSD Position** is set to 0, the OSD is shown at the top and bottom of the video screen. When it is set at a value between 1 and 5, the OSD is shifted towards the center of the video screen.

Similar to the subtitle shift setting above, the **OSD Position** feature is helpful for customers using a 2.35:1 “Constant Image Height” video projection system.

7. OSD Mode: Allows you to select how long the on-screen display (OSD) information, such as playback operation icons (**PAUSE**, **STOP**, **SKIP**, etc.), stays on the TV screen.

- **Normal** (default) – OSD information stays on the TV screen until the user cancels it.
- **Minimal** – OSD information stays on the TV screen for a few seconds and then disappears. The front panel display still maintains the selected display information.
- **Remaining** – OSD information stays on the TV screen until the user cancels it. By default, displays remaining time instead of elapsed time.
- **Off** – No OSD information shows on the TV screen unless the user presses the **INFO** button. This mode is not recommended for daily use

8. **Angle Mark (On/Off)** – Turns on/off the display of the angle icon when a DVD or Blu-ray Disc with multiple angles is played. Keeping the angle mark off avoids distraction from normal movie watching.

9. **Screen Saver** – Allows you to turn on/off the screen saver function. The screen saver is designed to minimize burn-in concerns for plasma and CRT display devices.
 - **On** (default) – After about 3 minutes of inactivity, the player will show an animated OPPO logo moving on a black background. This allows most areas of the screen time to rest and gives all areas an equal opportunity to refresh.
 - **Off** – The screen saver will not be activated. Only use this option if your TV does not have any burn-in issues.
 - **Energy Saver** – Video output will be turned off after 3 minutes of inactivity. Many projectors and LCD TVs will go into a standby or sleep mode and turn off their projection lamp or LCD backlight lamp, thus saving energy and prolonging the lamp life. When you press any button on the OPPO remote control or the player's front panel, the screen saver will be canceled and video output will be restored. If your TV is already in standby or sleep mode, you may need to wake up the TV by pressing a button on its remote or control panel.

10. **Parental Control:** Sets parental control ratings in order to prevent minors from watching inappropriate content. This function depends on whether the disc has been properly rated and encoded.
 - Press the **ENTER** button to bring up the rating selection menu.
 - Adjust the parental control settings by entering the current parental control password. If you have not yet set a parental control password, default the password is "0000".
 - The **Parental Control Menu** contains the following sub-items:
 - **BD Ratings** – Press the **UP/DOWN ARROW** buttons to select the rating allowed for Blu-ray Discs. **Off** means no ratings control and all discs are allowed to play. Numbers 1 to 21 corresponds to the age limit. Discs encoded with an age limit that is equal to or less than the selected age will be allowed, and any rating above the selected age will be blocked.
 - **DVD Ratings** – Press the **UP/DOWN ARROW** buttons to select the rating to allow for DVDs. The available ratings are Kid, G, PG, PG-13, PGR, R, NC-17, Adult and Off. The selected rating and below will be allowed, and any rating above will be blocked. If **Off** is selected, all discs are allowed to play.
 - **Area Code** – Some Blu-ray Discs may have different parental control ratings for different geographical areas. At this time the player only supports parental control ratings used in the United States.
 - **Change Password** – To change the parental control password, enter a 4-digit number as the new password. Enter the new password again to confirm. If the two entries match, the new password replaces the old parental control password.

Video Output Setup

The **Video Output Setup** section of the **Setup Menu** allows you to configure video output options.

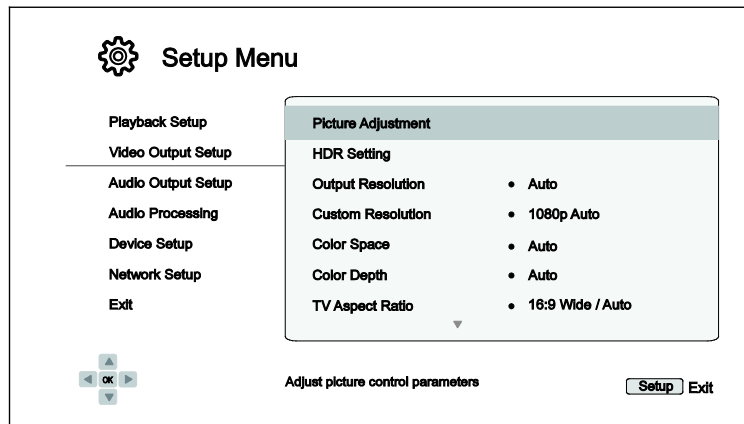

1. **Picture Adjustment:** Adjusts picture control settings. The UDP-205 provides a wide array of picture controls. Please refer to the **Picture Adjustment** section on page 56 for details about each control.
2. **HDR Setting:** Adjust the HDR and HDR to SDR conversion settings.
 - **HDR:** Allows you to choose the output mode for High-Dynamic Range content.
 - **Auto** (default) – Outputs HDR if supported by both the content and the display. The player automatically checks for HDR content and whether the TV or projector is HDR compatible, and if both criteria are met, the player outputs HDR video from its HDMI (Main) output terminal. Otherwise, only SDR video is output.
 - **Forced** – If the video content supports HDR, the player will always output video with HDR enabled regardless of whether or not the TV or projector indicates that HDR is supported. This may result in image abnormalities if the connected display does not support HDR.
 - **Off** – Always outputs video without HDR. HDR content will be converted to SDR.
 - **Strip Metadata** – HDR video will be converted to SDR but preserve the BT2020 color gamut. The player will strip off the HDR metadata from the HDR video.
 - **Target Luminance:** Allows you to adjust the target luminance for better HDR to SDR conversion. The luminance content higher than the target luminance will be mapped into the luminance range lower than the target luminance.
3. **Output Resolution:** Allows you to choose the output resolution that best matches your television's native resolution.
 - **Auto** (default) – Automatically set the optimal output resolution.
 - **Custom** – Set the output resolution according to the desired **Custom Resolution** setting.
 - **Source Direct** – Outputs at the original resolution of the source material.

NOTE

- DO NOT set the Output Resolution to Custom unless you know your TV's native resolution and the selected Custom Resolution is supported by your TV. For a detailed description on how to choose a proper output resolution, please refer to the **Select the Best Output Resolution** section on page 57 of this manual.
- There will be no video output or an "unsupported video signal" message may appear on screen if an unsupported output resolution is selected. To get the video back, you need to press the **RESOLUTION** button on OPPO remote until "**AUTO**" is displayed on the front panel of the UDP-205. Then press the **Enter** button on the OPPO remote or wait for a few seconds to confirm the selection. The player will automatically set its output resolution to a format that is supported by the TV.

4. **Custom Resolution:** Allows you to select a custom output resolution. The **Output Resolution** will be automatically changed to **Custom** if a new custom resolution is selected here. The following resolutions are available for the **Custom Resolution** setting:

- **UHD Auto** – Ultra HD (4K) output resolution with automatic frame rate. The frame rate will be 24Hz if the source content is natively 24Hz. 50/60Hz source content will be output as 4K 50/60Hz if the display device supports it, or as 4K 25/30Hz in the user specified color space.
- **UHD 24Hz** – Ultra HD (4K) output resolution with a 24Hz frame rate whenever possible. If the source content is not suitable for 4K 24Hz output, the output resolution will be 1080p 50/60Hz.
- **UHD 50Hz** – Ultra HD (4K) output resolution with a 50Hz frame rate.
- **UHD 60Hz** – Ultra HD (4K) output resolution with a 60Hz frame rate.
- **1080p Auto** – 1080p output resolution with automatic frame rate. The frame rate will be 24Hz if the source content is natively 24Hz and the display device supports 1080p 24Hz. 50/60Hz source content will be output as 1080p 50/60Hz.
- **1080p 24Hz** – 1080p output resolution with 24Hz frame rate preferred. The frame rate will be 24Hz if the source content is natively 24Hz. 50/60Hz source content will still be output as 1080p 50/60Hz.
- **1080p 50Hz, 1080p 60Hz, 1080i 50Hz, 1080i 60Hz, 720p 50Hz, 720p 60Hz, 576p, 576i, 480p, 480i** – Video will be up-scaled or down-scaled to these specific output resolutions.

NOTE

- **DO NOT** change the **Custom Resolution** unless you know your TV's native resolution.
- There will be no video output or an "unsupported video signal" message may appear on screen if an unsupported custom resolution is selected. To get the video back, you need to press the **RESOLUTION** button on OPPO remote until "**AUTO**" is displayed on the front panel of the UDP-205. Then press the **Enter** button on the OPPO remote or wait for a few seconds to confirm the selection. The player will automatically set its output resolution to a format that is supported by the TV.
- Press and hold the **RESOLUTION** button on the OPPO remote for 3 seconds to reset the player's Output Resolution, HDR, Color Space and Color Depth settings to their factory default settings.

5. Color Space: Allows you to select the color space for the HDMI video output.

- **Auto** (default) – The player checks with the display device to automatically determine what color space to use. If the display device supports YCbCr 4:4:4, then it will be used to avoid extra color space conversion.
- **RGB Video Level** – The HDMI output uses RGB color space and normal signal range suitable for video displays.
- **RGB PC Level** – The HDMI output uses RGB color space and expands the signal range. The expanded signal range is suitable for personal computer (PC) displays. Some TVs are designed to be used as a PC monitor, and expect signal in expanded RGB range when the DVI input is selected. For these displays if the video signal uses the normal RGB range, the black-white contrast will be reduced. You can set the player to use the RGB PC Level output and restore proper contrast.
- **YCbCr 4:4:4** – The HDMI output uses YCbCr 4:4:4 color space.
- **YCbCr 4:2:2** – The HDMI output uses YCbCr 4:2:2 color space. Generally this is the color space that is close to the color space encoded on the discs. (All discs are encoded in YCbCr 4:2:0 color space, and the video decoder decodes it into YCbCr 4:2:2.)
- **YCbCr 4:2:0** – The HDMI output uses YCbCr 4:2:0 color space. This is the color space that is the same as the color space encoded on the discs. (It is an experimental feature and only supports HDMI video output at UHD 60Hz and UHD 50Hz.)

6. Color Depth: Allows you to select the color depth mode for the HDMI video output. For displays that support increased color depth, you should see smoother color transitions and better gradients.

- **Auto** (default) – The player automatically determines the color depth mode based on the capabilities of the display device.
- **12-bit** – Always uses the 12-bit color depth mode.
- **10-bit** – Always uses the 10-bit color depth mode.
- **8-bit** – Always uses the 8-bit color depth mode.

NOTE

- For watching a UHD movie with HDR-10 color, you need to select Auto or 10-bit color depth to enable HDR output.
- The 12-bit and 10-bit color depth mode may not be supported by all TVs. Using the 12-bit or 10-bit color depth mode when connected to a TV that does not support it may result in no video.

7. TV Aspect Ratio: Sets the aspect ratio of the player's output image.

- **16:9 Wide** – 16:9 content will be displayed in its native aspect ratio, and 4:3 contents will be stretched horizontally.
- **16:9 Wide / Auto** (default) – 16:9 content will be displayed in its native aspect ratio, and 4:3 content will be displayed with black borders on both sides in order to maintain the original 4:3 aspect ratio.







For a detailed description on how to choose a proper TV Aspect Ratio, please refer to the **Determine the Display Aspect Ratio** section on page 58 of this manual.

- 8. 3D Setting:** Adjusts the playback settings for better 3D visual quality.
- **3D Output** – Allows you to choose the video output mode for 3D content.
 - **Auto** (default) – Outputs 3D if supported both by both the disc content and the display. The player automatically checks for the existence of 3D content on the disc and the 3D compatibility of the TV or projector. If both criteria are met, the player sends 3D video from its HDMI output terminals; otherwise, only 2D video is sent out. You may need to wear 3D glasses that come with your TV in order to view 3D movies.
 - **Off** – Always output 2D video format, even when 3D video exists on the disc. This guarantees the video quality if your TV is not 3D compatible, or if some necessary components (such as the 3D glasses) are missing.
 - **Forced** – Always output 3D video format for 3D Blu-ray Discs. You may experience a black screen (no video output) if your TV is not 3D compatible.
 - **2D->3D Depth** – Adjusts the 3D depth perception when performing 2D-to-3D conversion (also called “simulated 3D”). The default value is 8.
 - **3D TV Size** – Allows you to enter the diagonal screen size of the 3D HDTV. Use the number buttons on the remote to enter the actual diagonal size of the TV screen, and then press the **ENTER** button to confirm. The default value is 46 inches. This value does not directly affect video quality, but some 3D movies may use this value to decide how to place certain graphics.
- 9. DVD 24p Conversion:** Allows you to enable 24Hz frame rate conversion for DVD. This option is only available when **Output Resolution** is **Auto**, **Output Resolution** is **Custom** and **Custom Resolution** is **UHD Auto/UHD 24Hz/1080p Auto/1080p 24Hz**. Many DVDs that originate from theatrical movies are encoded with a technique called “3:2 telecine” in order to convert the 24 frames per second film to 60Hz video signal. The player can convert the 60Hz video signal back to 24 frames per second film and output as 24Hz. Smoother motion may be achieved by enabling this option, if both the TV and the DVD disc meet the conversion conditions. The available options are:
- **On** – Converts DVD to 24Hz frame rate when possible. Remember that motion errors may be observed if the DVD is not suitable for such conversion.
 - **Off** (default) – Does not convert DVD to 24Hz frame rate.
- 10. De-interlacing Mode:** Allows you to select the appropriate algorithm that the player should use to convert interlaced video on a DVD or Blu-ray Disc to progressive output. A proper de-interlacing mode will ensure the output video matches the original contents and is free of de-interlacing artifacts. The available options are:
- **Auto** (default) – Automatically selects the de-interlacing mode depending on the video type. This is the recommended setting as it sets the player to optimally process a variety of signal types.
 - **Film** – De-interlacing the video originally made in film mode. The mode may improve film mode detection in some cases.
 - **Video** – De-interlacing the video originally shot with a video camera. Use this setting only if you are certain the disc is made from footage originally not shot with a film camera.

Picture Adjustment

Picture Adjustment is a special section of the **Video Output Setup** menu. It allows you to fine tune many picture control parameters in order to achieve optimal picture quality. To enter the **Picture Adjustment** menu, press the **SETUP** button on the remote control to enter the player's **Setup Menu** and choose **Video Output Setup>Picture Adjustment**.

Since the player is equipped with only the HDMI OUT (Main) output port for video output, the **Picture Adjustment** menu will come up directly for HDMI output.

Picture Adjustment		
Picture Mode	Mode 1	
Brightness	0	-16  +16
Contrast	0	-16  +16
Hue	0	-16  +16
Saturation	0	-16  +16
Sharpness	0	0  +16
Noise Reduction	0	0  +3
Exit		

Picture Adjustment Menu

To change a picture adjustment parameter, use the **UP/DOWN ARROW** buttons to highlight the parameter, and use the **LEFT/RIGHT ARROW** buttons to change its value.

To aid in the adjustment of picture control parameters, the picture adjustment menu will be reduced to only show the parameter being adjusted once you press the **LEFT/RIGHT ARROW** buttons (except the **Picture Mode**, which you will directly see the mode name switches between Mode 1, 2 and 3, and all the other parameters are adjusted automatically to the stored value). The reduced menu will be positioned near the bottom of the screen.

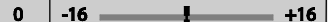
Brightness	0	-16  +16
------------	---	--

You can continue adjusting the current parameter by pressing the **LEFT/RIGHT ARROW** buttons. To select another parameter, press the **UP/DOWN ARROW** buttons. Press the **ENTER** button to return to the main **Picture Adjustment** menu.

To exit the **Picture Adjustment** menu and return to the **Setup Menu**, either select **Exit** in the menu, or press the **RETURN** button.

1. **Picture Mode:** The UDP-205 allows you to save up to three customized modes. Press the **LEFT/RIGHT ARROW** buttons to switch the mode and all parameters will be automatically adjusted to their stored values. Changes to the current parameter values will be stored automatically when you exit the **Picture Adjustment** screen or switch to another **Picture Mode**.
2. **Brightness:** Allows you to adjust the brightness (black level) of the video output.
3. **Contrast:** Allows you to adjust the contrast (white level) of the video output.

NOTE

- Proper brightness and contrast settings are necessary for a quality video output. If you do not have the correct black and white levels, your images can appear washed out or can lose detail in shadows when watching darker scenes. Televisions have brightness (black level) and contrast (white level) controls; however, it may require a combination of

tweaking both the player and your television to get the optimal result. We recommend using a calibration disc such as the *Spears & Munsil™ High Definition Benchmark Blu-ray Edition* or *Digital Video Essentials HD Basics* as aids for adjusting. First adjust the television's picture controls for the best possible picture. Once that is done, try changing the player's settings to further refine the picture to the optimal result.

4. **Hue:** Allows you to adjust the hue (tint) of the video output.
5. **Saturation:** Allows you to adjust the saturation (color intensity level) of the video output.
6. **Sharpness:** Allows you to set the sharpness of video output. Sharpness is a video processing function that can control the image sharpness but at the same time may cause unwanted artifacts. The sharpness level can be set between 0 and +16. The default is level 0. The higher the level, the sharper the video details are. However, too high a sharpness level may cause white lines or halo-like effects to appear around objects.
7. **Noise Reduction:** Allows you to select whether the player will apply video noise reduction processing. The default is level 0, which turns off noise reduction. When this level is increased, the player adjusts the picture quality by applying video noise reduction. The higher the level, the more aggressively noise reduction functions are applied.

Remember that excessive noise reduction may cause a loss of detail. We recommend using the noise reduction function only when you encounter poorly encoded or compressed video that has apparent noise artifacts.

Select the Best Output Resolution

One of the major advantages of the UDP-205 is its ability to play Ultra High-Definition Blu-ray video and also up-convert high-definition video and standard definition video to Ultra High-Definition. The player offers several standard, HD and UHD video output resolutions. For best results, it is important to select an output resolution that best matches your TV or display.

The rule of thumb when selecting an output resolution is to match the native resolution of your TV or display as closely as possible. The native resolution is the resolution of the actual display component in the TV, such as the OLED panel, Plasma panel, LCD panel, or DLP™ chip. The TV may accept input signals with lower or higher resolutions than its native resolution. In such cases, the electronics in the TV will upscale or downscale the video to fit its display component. Unfortunately, many TVs on the market only do an average job of scaling the video and if you set the UDP-205 to output a resolution that matches or is very close to the native resolution of the TV, you are more likely to get a great picture. Most TVs or projectors can communicate their native resolution to the player via the HDMI connection, so setting the **Output Resolution** to **Auto** is generally the best choice for most customers. However in rare cases the TV or projector may not correctly present its native resolution, or the installer may decide a certain resolution works better. The UDP-205 can be set to a fixed **Custom Resolution** if so desired.

For most new displays on the market, the best output resolution will be either UHD or 1080p. A few early model "1080p" displays did not accept a 1080p signal. For these displays, the best output resolution is 1080i. For small screen digital TVs this will likely be 720p. For even earlier CRT tube or rear projection TVs this will likely be 1080i. For EDTV displays (very rare if they have HDMI or DVI) this will be 480p (NTSC) or 576p (PAL). These are general recommendations that work for most users, but there can be exceptions. Advanced users may want to try all supported resolutions and choose the one that provides the best result visually.

The UDP-205 supports a special **Source Direct** mode through its HDMI outputs. This resolution is recommended for use with external video processors or high-end TVs. In **Source Direct** mode, the player

works as a “transport”. It decodes video from the discs and then sends the raw video signal in its native resolution and format, without extra processing, to the external video processor or TV. The actual output resolution varies by content:

Content	Source Direct Output Resolution
NTSC DVD	480i
PAL DVD	576i
Most Blu-ray Movies (film-source)	Ultra HD (4K) 23.976Hz or Ultra HD (4K) 24Hz 1080p 23.976Hz or 1080p 24Hz
Most Blu-ray TV shows or Concerts (video-source)	1080i
SACD and DVD-Audio	1080p

The UDP-205 allows the installer to choose a **Custom Resolution** in the **Setup Menu**. Customer can switch between the **Auto** output resolution and the pre-selected **Custom Resolution** by pressing the **RESOLUTION** button on the remote control.

Determine the Display Aspect Ratio



Standard Definition, or 4:3 TV



Wide Screen, or 16:9 TV

The **TV Aspect Ratio** is the proportional ratio of a TV screen’s width and height. Older television sets generally have a 4:3 aspect ratio – the width is 4/3 (or 1.33) times the height. Newer wide screen television sets have a 16:9 aspect ratio – the width is 16/9 (or 1.78) times the height. Although 4:3 TVs are very rare nowadays, program content originally formatted with a 4:3 aspect ratio is still very common. The **Aspect Ratio** setting decides how this type of 4:3 program content is displayed on a 16:9 TV screen.

The **Aspect Ratio** selections are **16:9 Wide** and **16:9 Wide/Auto**. Depending on your selection and the video format recorded on the discs, image appearance on the TV screen can be one of the following:

Original Content	TV Screen Appearance	
	16:9	
	Wide	Wide/Auto
4:3 		
16:9 		

Audio Output Setup

The **Audio Output Setup** section of the **Setup Menu** allows you to configure audio output options.

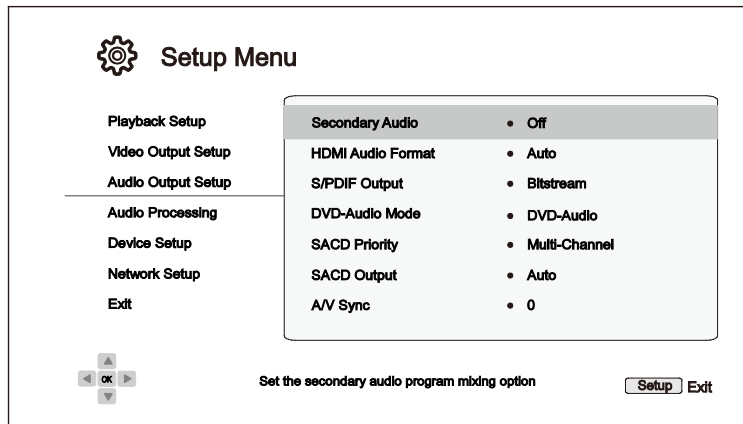

1. **Secondary Audio:** Allows you to set the Secondary Audio Program mixing option. Some Blu-ray Discs contain a secondary audio and video program, such as a director's commentary. Some Blu-ray Discs have a sound effect when you make menu choices. This **Setup Menu** item allows you to decide whether to mix the Secondary Audio Program and menu sounds into the primary audio.
 - **On** – The Secondary Audio Program and menu sounds are mixed into the primary audio. Usually this will cause the primary audio volume to be slightly reduced.
 - **Off** (default) – The Secondary Audio Program and menu sounds are not mixed into the primary audio and you cannot hear the secondary audio or menu sounds. This setting preserves the highest possible audio quality for the primary audio.

2. **HDMI Audio Format:** Allows you to select the digital audio output format from the HDMI port. The options are:
 - **Auto** (default) – The player checks with the device connecting to the HDMI output to automatically determine which audio format to use.
 - **LPCM** – Digital audio output via HDMI will be in the multi-channel Linear PCM format. When this option is selected, compressed audio bit streams will be decoded by the player. This setting is recommended when connecting the HDMI output directly to a TV or to a receiver without advanced audio decoding capabilities.
 - **Bitstream** – Digital audio output via HDMI will be in bitstream format. This option is recommended when connecting the HDMI output to an A/V receiver or processor that supports advanced audio decoding, such as Dolby Atmos, Dolby TrueHD and DTS:X, DTS-HD Master Audio.
 - **Off** – No digital audio output via HDMI.

NOTE

- If you use HDMI to connect audio to an HDMI A/V receiver or audio processor, it is important that you choose 720p or higher HDMI output resolution when playing high resolution audio content (DVD-Audio, SACD, Dolby TrueHD and DTS-HD Master Audio). According to the HDMI specification, the bandwidth available for audio is proportional to the total bandwidth used by video. At 480p/576p resolution, the HDMI specification can

only support 2 channels of audio with high sample rate (up to 192kHz), or 8 channels of audio with standard sample rate (up to 48kHz). If you play high resolution audio content at the 480p/576p resolution, you may get reduced audio resolution, incomplete audio channels, or even no audio/video output at all. Choosing a higher output resolution such as 720p or above allows enough bandwidth for all high sample rate audio channels.

3. **S/PDIF Output:** Allows you to set the audio format and the upper sample rate limit for coaxial/optical (S/PDIF) digital outputs. The upper sample rate limit is used to decide whether the player shall down-sample audio (the player does not up-sample audio to higher sample rates).
 - **48k LPCM** – Forces down-mixed 2-channel, linear PCM (LPCM) digital audio format, and sets the maximum sample rate to 48kHz. This is supported by most receivers/amplifiers.
 - **96k LPCM** – Forces down-mixed 2-channel, linear PCM (LPCM) digital audio format and sets the maximum sample rate to 96kHz. It can result in better audio quality but ensure the receiver/amplifier can support it.
 - **192k LPCM** – Forces down-mixed 2-channel, linear PCM (LPCM) digital audio format and sets the maximum sample rate to 192kHz. It can result in better audio quality but ensure the receiver/amplifier can support it.
 - **Bitstream** (default) – Passes audio as compressed bit-stream format to the receiver/amplifier. Choose this setting if your receiver/amplifier is capable of decoding Dolby Digital and/or DTS.

NOTE

- Due to copyright restrictions and bandwidth limitations, SACD audio cannot be sent through the coaxial/optical audio output, and the high resolution audio on DVD-Audio and Blu-ray discs will be sent out at reduced resolution. Details can be found on page 15.

4. **DVD-Audio Mode:** Select which portion of a DVD-Audio disc to play.
 - **DVD-Audio** (default) – Play the DVD-Audio portion of the disc with high-resolution audio.
 - **DVD-Video** – Play the DVD-Video portion of the disc with Dolby Digital or DTS audio.
5. **SACD Priority:** Select which audio layer to play for SACD (Super Audio CD).
 - **Multi-Channel** (default) – Play the high resolution multi-channel surround audio layer
 - **Stereo** – Play the high resolution 2-channel stereo audio layer
 - **CD Mode** – Play the CD layer of a hybrid SACD disc
6. **SACD Output:** Allows you to select the audio output format for SACD playback.
 - **Auto** (default) – The player checks with the device connected to the HDMI output to automatically determine which audio format (DSD or PCM) to use for SACD playback.
 - **PCM** – SACD data is converted into multi-channel, high-resolution PCM data. The converted PCM data is then output through HDMI or the internal DAC (Digital to Analog Converter) for the analog audio output ports. If you use a receiver that supports HDMI v1.1 to listen to SACD, please select this option. You may also want to select this option if you prefer the sound quality of the DSD-to-PCM conversion.

- **DSD** – SACD Direct Stream Digital (DSD) data is output over HDMI without any conversion. For the analog audio outputs, DSD data is converted into an analog signal directly by the internal DAC. If you use a receiver that supports HDMI v1.2a with DSD over HDMI, or you prefer the sound quality of straight DSD to analog, please select this option.
7. **A/V Sync:** Allows you to add a slight delay to the audio so it is synchronized to the video. You may use the **LEFT/RIGHT ARROW** buttons on the remote to decrease/increase the audio delay. The delay can be adjusted in 10ms steps and within the range of -100ms to +200ms. The delayed time will be applied to all output terminals including HDMI, Coaxial, Optical, Stereo (or 7.1) outputs.

NOTE

- The actual audio delay effect might be different for each of the output terminals due to the different audio process algorithms and signal paths used for each output. Please adjust this setting based on the actual output terminal in use.
- The negative adjustment values are for cancelling out the audio delay that the player automatically applies. Depending on the video source and the time it takes to process the video, the main decoder chip automatically applies an audio delay in order to optimize audio video synchronization. The negative manual settings reduce the automatic audio delay, while the positive manual settings apply additional delay. Any negative value setting beyond the player's automatic delay will be treated as completely cancelling the automatic delay. For example, if the A/V Sync value is manually set to -100ms and for the current video source the player applies a 70ms automatic audio delay, the final result is that the 70ms audio delay gets cancelled and the audio is not delayed at all. It is not possible to put audio ahead of video using this setting.

Audio Signal Reference Chart

Blu-ray Discs may contain many types of audio signal formats, some of which are high resolution types such as Dolby TrueHD and DTS-HD Master Audio. Blu-ray Discs also have many optional audio components such as the Secondary Audio Program and menu clicking sound. The player's **Audio Output Setup** menu allows you to configure the audio output to meet your specific preference. The following chart provides a reference to what type of audio signal can be expected.

When **Secondary Audio** is set to **Off** :

Output Ports Setting Source Format	HDMI Output		Coaxial/Optical Output		Analog Multi- Channel Output
	Bitstream	LPCM	Bitstream	LPCM	
LPCM 2ch	LPCM 2ch	LPCM 2ch	LPCM 2ch	LPCM 2ch	2ch
LPCM 5.1ch	LPCM 5.1ch	LPCM 5.1ch	DTS 5.1ch	LPCM 2ch	5.1ch
LPCM 7.1ch	LPCM 7.1ch	LPCM 7.1ch	DTS 5.1ch	LPCM 2ch	7.1ch
Dolby Digital	Dolby Digital	LPCM 5.1ch	Dolby Digital	LPCM 2ch	5.1ch
Dolby Digital Plus	Dolby Digital Plus	LPCM up to 7.1ch	Dolby Digital	LPCM 2ch	Up to 7.1ch
Dolby TrueHD	Dolby TrueHD	LPCM up to 7.1ch	Dolby Digital	LPCM 2ch	Up to 7.1ch
DTS	DTS	LPCM up to 7.1ch	DTS	LPCM 2ch	Up to 7.1ch
DTS-HD High Resolution	DTS-HD High Resolution	LPCM up to 7.1ch	DTS (core)	LPCM 2ch	Up to 7.1ch
DTS-HD Master Audio	DTS-HD Master Audio	LPCM up to 7.1ch	DTS (core)	LPCM 2ch	Up to 7.1ch

When **Secondary Audio** is set to **On** and the player encounters a disc with a secondary audio track or menu sounds:

Output Ports Setting Source Format	HDMI Output		Coaxial/Optical Output		Analog Multi- Channel Output
	Bitstream	LPCM	Bitstream	LPCM	
LPCM 2ch	LPCM 2ch	LPCM 2ch	LPCM 2ch	LPCM 2ch	2ch
LPCM 5.1ch	LPCM 5.1ch	LPCM 5.1ch	DTS 5.1ch	LPCM 2ch	5.1ch
LPCM 7.1ch	LPCM 7.1ch	LPCM 7.1ch	DTS 5.1ch	LPCM 2ch	7.1ch
Dolby Digital	Dolby Digital*	LPCM up to 5.1ch	Dolby Digital*	LPCM 2ch	5.1ch
Dolby Digital Plus	Dolby Digital*	LPCM up to 7.1ch	Dolby Digital*	LPCM 2ch	Up to 7.1ch
Dolby TrueHD	Dolby Digital*	LPCM up to 7.1ch	Dolby Digital*	LPCM 2ch	Up to 7.1ch
DTS	DTS*	LPCM up to 7.1ch	DTS*	LPCM 2ch	Up to 7.1ch
DTS-HD High Resolution	DTS*	LPCM up to 7.1ch	DTS*	LPCM 2ch	Up to 7.1ch
DTS-HD Master Audio	DTS*	LPCM up to 7.1ch	DTS*	LPCM 2ch	Up to 7.1ch

Note: All audio output signals are mixed with primary, second audio and menu sounds. "Dolby Digital*" and "DTS*" denote mixed audio re-encoded into the original bitstream audio format.

Recommended Audio Format Options

Depending on your specific audio/video connection method, the Audio Output Setup options of the UDP-205 may need to be adjusted to match your configuration. Refer to the video and audio connection methods described previously in this guide and the following audio setup guidelines.

Audio Connection Directly to TV

If the player is connected directly to the TV through HDMI (as described on page 13) or through DVI and analog L/R audio cables, it is recommended that you use the following audio format options:

- **Secondary Audio:** **On**
- **HDMI Audio Format:** **LPCM**
- **SACD Output:** **PCM**
- **S/PDIF Output:** (any – not in use)

Multi-Channel Digital Audio to Receiver through HDMI

If the player is connected to an A/V receiver or processor with HDMI inputs (as described on page 12), you can send all current audio formats to your receiver in pure digital form. To get the best possible audio via HDMI, you may need to set the following options on the player's **Audio Output Setup** menu:

- If your receiver supports HDMI v1.3 with decoding capability for high resolution lossless audio formats such as Dolby TrueHD and DTS-HD Master Audio, please use the following audio output setup options:
 - **Secondary Audio:** **Off** (or **On** if you need secondary audio)
 - **HDMI Audio Format:** **Bitstream**
 - **SACD Output:** **PCM** (or **DSD** if the receiver supports DSD over HDMI)
 - **S/PDIF Output:** (any – not in use)
- If your receiver supports HDMI v1.1/1.2 Multi-Channel PCM audio, but not high resolution lossless audio formats such as Dolby TrueHD and DTS-HD Master Audio, please use the following audio output setup options:
 - **Secondary Audio:** **Off** (or **On** if you need secondary audio)
 - **HDMI Audio Format:** **LPCM**
 - **SACD Output:** **PCM** (or **DSD** if the receiver supports DSD over HDMI)
 - **S/PDIF Output:** (any – not in use)

Multi-Channel Analog Audio to Receiver

If the player is connected to an A/V receiver through the 7.1ch or 5.1ch analog audio jacks using 8 or 6 RCA cables (as described on page 15), you can play all supported audio formats and listen to them with your A/V receiver and surround sound systems. The following audio output setup options are recommended:

- **Secondary Audio:** **Off** (or **On** if you need secondary audio)
- **HDMI Audio Format:** **Off**
- **SACD Output:** **PCM** or **DSD** (depending on your listening preference)
- **S/PDIF Output:** (any – not in use)

Also set the **Speaker Configuration** in the **Audio Processing** menu:

- Set **Down Mix** to **7.1Ch** or **5.1Ch**.

- Set the speaker size and subwoofer according to your actual audio hardware. (see page 69)
- Enable or select the multi-channel analog inputs on your receiver

Stereo Analog Audio to Receiver

If you primarily listen to stereo content or if your receiver only offers stereo audio connections, please use the analog RCA-style cables to connect the FL (Front Left) and FR (Front Right) terminals of the player to your receiver (as described on page 15). The following audio output options are recommended:

- **Secondary Audio:** Off (or On if you need secondary audio)
- **HDMI Audio Format:** Off
- **SACD Output:** PCM or DSD (depending on your listening preference)
- **S/PDIF Output:** (any – set to **192k LPCM** may help to get the best analog audio quality)

Coaxial or Optical Digital Audio to Receiver

If the player is connected to an A/V receiver with Coaxial/Optical inputs (as described on page 15), and the A/V receiver supports Dolby Digital and DTS decoding, the following audio output setup options are recommended:

- **Secondary Audio:** Off (or On if you need secondary audio)
- **HDMI Audio Format:** Off
- **SACD Output:** (any – SACD is not available through S/PDIF out puts)
- **S/PDIF Output:** Bitstream

Audio Processing Setup

The **Audio Processing** section of the **Setup Menu** allows you to configure how the player will process audio signals before sending them to the output. In this section, all of the settings only affect the analog audio outputs, except for Dynamic Range Control (DRC), which also affects HDMI audio.

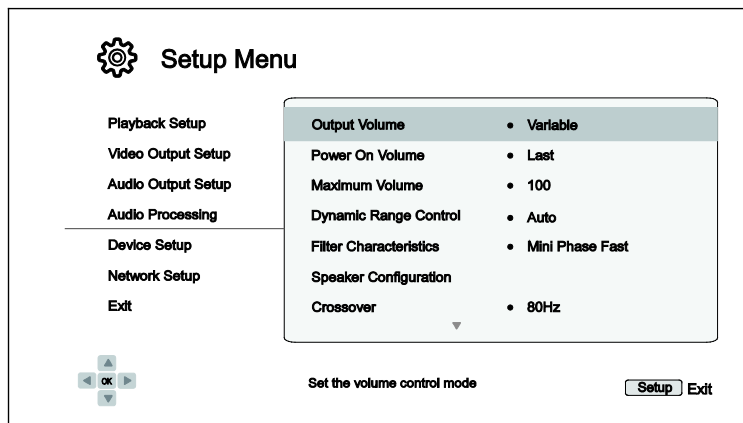

1. **Output Volume:** Allows you to enable or disable the analog volume controls (also known as Variable Audio). The available options are:
 - **Variable** (default) – Enables the analog volume control. Use the **VOL+/-** buttons on the remote to decrease/increase the analog audio output level (the maximum is 100).
 - **Fixed** – Disables the analog volume control. The **VOL+/-** buttons on the remote will no longer affect the analog audio output, and the volume level is fixed to 100.
2. **Power On Volume:** Allows you to set the initial audio volume level after power on. This option will be applied to the stereo and 7.1 audio outputs.
 - **Last** (default) – Power on with the previous volume level before the player was turned off. This choice is recommended for regular use.
 - **40** (custom) – Power on with your preferred volume level. You may use the **LEFT/RIGHT ARROW** buttons on the remote to decrease/increase the volume level. The default level is 40.
3. **Maximum Volume:** Allows you to set the maximum volume level. This option will be applied to the stereo and 7.1 audio outputs. You may use the **LEFT/RIGHT ARROW** buttons on the remote to decrease/increase the volume level. The default value is 100.
4. **Dynamic Range Control:** Allows you to set the Dynamic Range Compression (DRC). DRC can smooth out the sonic peaks and valleys common with wide-range digital audio. Enabling DRC may make low level audio more audible during low-level listening. Turning off DRC restores the sonic energy present in the original recording.
 - **Auto** (default) – Plays at the dynamic range specified by the disc. This option applies to certain Blu-ray Discs only, which have DRC instructions encoded in the Dolby TrueHD audio tracks.
 - **On** – Turn on DRC for all Dolby and DTS audio formats. This option applies to all DVD and Blu-ray Discs.
 - **Off** – Turn off DRC.

NOTE

- Dynamic Range Compression is applied to the analog audio output and digital audio outputs (HDMI, Coaxial and Optical) when the audio format is set to PCM.

5. **Filter Characteristics:** Configure the digital filter for the audio DAC. Some customers may prefer one type of filter over others.
 - **Brick Wall** – Select the Brick Wall filter.
 - **Corrected Mini Phase Fast** – Select the Corrected Minimum Phase Fast filter.
 - **Apodizing Fast** – Select the Apodizing Fast filter.
 - **Mini Phase Slow** – Select the Minimum Phase Slow filter.
 - **Mini Phase Fast** (default) – Select the Minimum Phase Fast filter.
 - **Linear Phase Slow** – Select the Linear Phase Slow filter.
 - **Linear Phase Fast** – Select the Linear Phase Fast filter.
6. **Speaker Configuration:** In the **Speaker Configuration** menu you can configure speaker settings such as down-mix mode, number of speakers, their distance, size and trim level. The **Speaker Configuration** menu shows an illustration of speaker placement to assist you in properly configuring your speakers. Please refer to the **Speaker Configuration** section on page 68 for details of each option.
7. **Crossover:** Allows you to set the Bass Management kick-in frequency for all speakers. When the speaker size is set to **Small** in **Speaker Configuration** (see page 69), bass information below this frequency is not passed to the speakers to reduce possible distortion, and if the subwoofer is available, bass information will be redirected to the subwoofer. When all speaker sizes are set to **Large**, there is no Bass Management.
 - **40Hz / 50Hz / 60Hz / 70Hz / 80Hz / 90Hz / 100Hz / 110Hz / 120Hz / 130Hz / 140Hz / 150Hz / 160Hz / 200Hz / 250Hz** – These are the available crossover frequencies. You can press the **UP/DOWN ARROW** buttons and the **ENTER** buttons to select it. This option applies to all speakers (center front, surround, and surround back speakers). By default the crossover frequency is **80Hz**.
8. **DTS Neo:6 Mode:** Allows you to enable DTS Neo:6 audio processing and select the listening mode. DTS Neo:6 is a digital signal processing that can expand the original stereo source to 7.0 (L, R, C, L_S, R_S, L_R, R_R) or 7.1 (with Bass Management) surround.
 - **Music** – Enables DTS Neo:6 audio processing for stereo music sources.
 - **Cinema** – Enables DTS Neo:6 audio processing for digital TV box or stereo movie sources.
 - **Off** (default) – Turns off the DTS Neo:6 to keep the original audio quality.
9. **Headphone Volume:** Allows you to enter the default volume level for the headphone output. To change the level, press the **ENTER** button to bring the volume setting bar and press the **LEFT/RIGHT ARROW** or **VOL+/-** buttons to adjust the value. By default the volume level is set to 75.
10. **XLR Terminal Polarity:** To set the polarity of the BALANCED STEREO AUDIO OUT terminals on UDP-205. Please compare the positions of “hot” (positive) and “cold” (negative) pins on UDP-205 terminals (show in the page 16) with those on your audio system. The available options are:

- **Normal** (default) – The XLR three-pin positions on your audio system are the same as those on UDP-205 terminals.
 - **Inversion** – The positions of “hot” (positive) and “cold” (negative) pins on your audio system are switched comparing with those on UDP-205 terminals.
11. **Stereo Signal:** To select the audio source that will be processed and sent out through the STEREO and the XLR BALANCED STEREO audio terminals. The available options are:
- **Down-mixed Stereo** (default) – The stereo or down-mixed stereo signals are processed and sent out from the dedicated stereo output terminals.
 - **Front Left/Right** – The original Front Left (FL) and Front Right (FR) signals are sent out from the dedicated stereo output terminals. The purpose is to fully utilize the better DAC hardware originally assigned to the dedicated stereo outputs for customers who prefer multichannel speakers and do not need the dedicated stereo output or zone 2 output. When this option is selected, the dedicated stereo output ports should be used as the Front outputs of the 7.1ch / 5.1ch / Stereo Audio group. The original FL/FR RCA connectors should not be connected.

Speaker Configuration

In the **Speaker Configuration** menu you can configure speaker settings such as down-mix mode, number of speakers, their distance, size and trim level. The **Speaker Configuration** menu shows an illustration of speaker placement to assist you in properly configuring your speakers.

Upon entering this menu, the cursor is positioned on the front left speaker. You may use the **LEFT/RIGHT ARROW** buttons to move the cursor. The **RIGHT ARROW** button moves the cursor clockwise, and the **LEFT ARROW** button moves the cursor counterclockwise. When the cursor is over the **Down Mix**, **Test Tone** or **Exit** options, you can also use the **UP/DOWN ARROW** buttons to highlight these options.

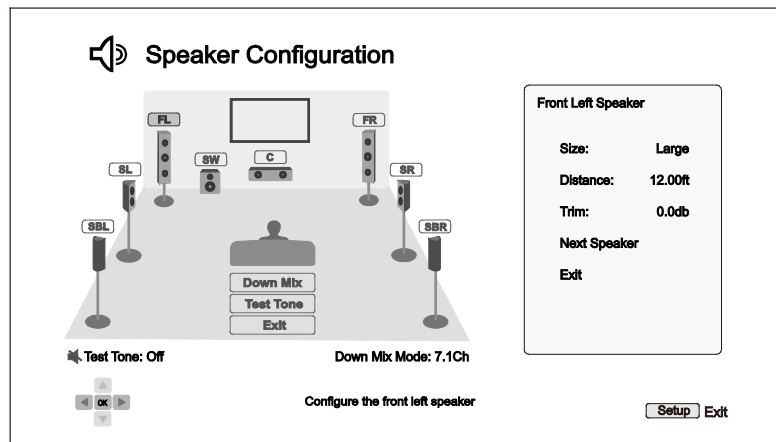

NOTE

- **Dynamic Range Control (DRC)** and **AV Sync** also affect the HDMI, coaxial, and optical outputs.
- **Speaker Configuration** mainly applies to the multi-channel analog audio outputs. However, when **S/PDIF Output** is set to **LPCM** in the **Setup Menu**, its signal becomes a down-mixed stereo version of the multi-channel signal that is sent to the multi-channel analog audio outputs. As a result, the LPCM signal from the coaxial and optical output is affected by the settings in **Speaker Configuration**.
- HDMI is unaffected by the settings in **Speaker Configuration**, and the coaxial and optical outputs are also unaffected by these settings when **S/PDIF Output** is set to **Bitstream**.

Down Mix Mode

Downmixing is the process of converting multi-channel audio to a lesser number of channels. For example, converting a 5.1ch source to stereo or converting a 7.1ch source to 5.1ch. Downmixing allows the audio output from the player to match the exact number of speakers available in your home theater.

The current down mix mode is displayed in the lower right corner of the speaker placement illustration. To change the audio down mix setting, press the **ENTER** button while the cursor is over the **Down Mix** option. The following down mix modes are available:

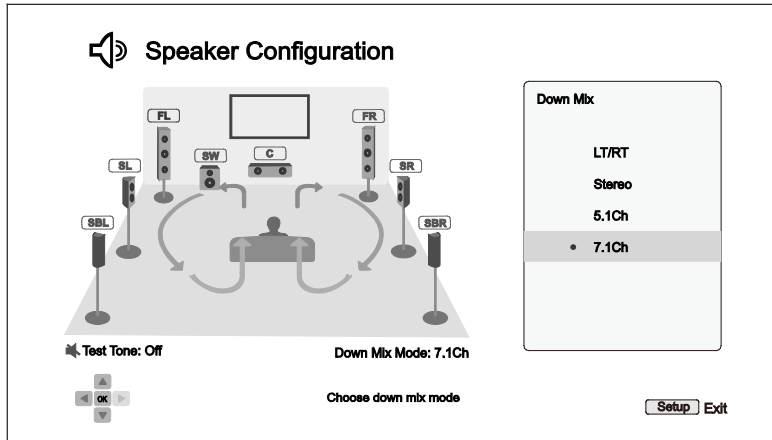

- **LT/RT** – Left Total/Right Total. The center and surround channels are mixed into the two front channels according to the LT/RT matrix. A Dolby Pro Logic receiver will decode the two-channel audio into surround audio.
- **Stereo** – This mode down mixes multi-channel audio to 2-channel stereo output. For original stereo content the output will not change. For original multi-channel content the surround and center channels will be mixed with the left and right front channels. This is recommended for use with TV sets or stereo receiver/amplifiers.
- **5.1Ch** – This mode enables 5.1ch decoded audio output. The number of actual output channels depends on the disc. If the source content has more channels, the surround back channels will be mixed into the surround channels.
- **7.1Ch** (default) – This mode enables 7.1ch decoded audio output. The number of actual output channels depends on the disc. For 6.1ch contents, the left and right surround back speakers will both output the same surround back audio channel.

Test Tone

Test tones are artificially-created sounds that are used to test your audio speaker system and help to identify any wiring faults. By default the **Test Tone** is set to **Off**, with the status displayed in the lower left corner of the screen.

To begin the test, press the **ARROW** buttons to highlight the **Test Tone** option, and press the **Enter** button to change the test tone status to **On**. Press the **ARROW** buttons to select a speaker, and you will hear the test sounds. To stop the test process, press the **ARROW** buttons to highlight the **Test Tone** option and press the **Enter** button to switch the status back to **Off**.

Please note these test tones only work with the multi-channel analog audio outputs and are only suitable for channel identification purposes. For comprehensive speaker configuration, we recommend using the dedicated test tones found on professional audio calibration discs.

Speaker Settings

You can set the size, distance and trim level for each speaker by using the **LEFT/RIGHT ARROW** buttons to move the cursor to highlight the speaker and then press the **ENTER** button. The **Speaker Settings** menu on the right side of the screen will be activated. In **Speaker Settings**, use the **UP/DOWN ARROW** buttons to select a parameter, and then press the **ENTER** button to change it. To exit the **Speaker Settings** menu and return to the Speaker Configuration illustration, press the **LEFT**

ARROW button or select the **Exit** option. You can also move on to configure the next speaker by selecting the **Next Speaker** option.

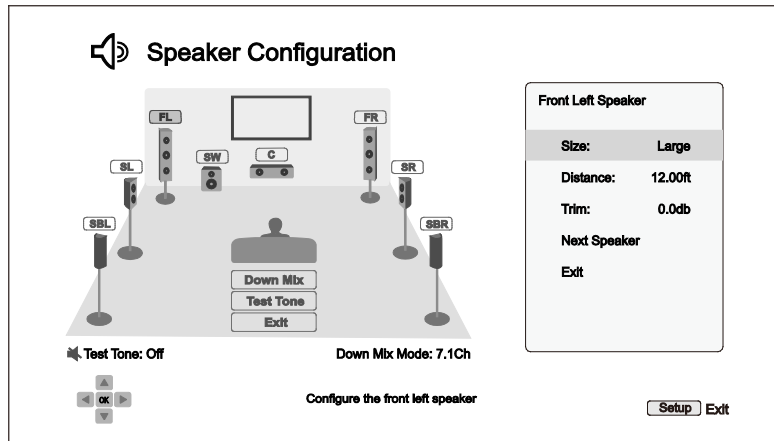

The following speaker parameters can be configured:

1. **Size:** The following speaker size parameters control bass filtering for the speakers.
 - **Large** – All audio content is passed to the appropriate speaker.
 - **Small** – All audio content, except for bass frequencies, is passed to the appropriate speaker. The purpose is to reduce possible distortion. If a subwoofer is available, bass frequencies are re-directed to the subwoofer, otherwise, they are discarded. The bass frequency upper limit is set by the **Crossover Frequency** selection in the **Setup Menu** (see page 66 for details).
 - **Off** – Speaker for the corresponding position does not exist. Audio for the missing speaker is redirected to other speakers or discarded if redirection is not possible.
 - **On** (for Subwoofer only) – Specifies that a subwoofer is available.

NOTE

- The **Size** for Front, Surround and Surround Back speakers is configured in pairs. Changes to the size of one speaker will automatically change the other of the pair.

2. **Distance:** The speaker distance parameters set delay control for the corresponding audio channel. The delay is to compensate for the audio propagation time difference caused by the placement of speakers.

Speaker distance compensation is not required if the A/V receiver has the capability to adjust channel delay and compensate for speaker distance differences. However, if your receiver does not have such functions (most receivers do not offer these functions for their multi-channel analog input), you may adjust them through the player. Speaker distance delay is only applied if the player is decoding multi-channel audio. If you use bitstream audio output to your A/V receiver, the bitstream audio is not adjusted for speaker distance delay.

A typical 7.1-channel speaker layout and their speaker distance measurements are displayed as below:

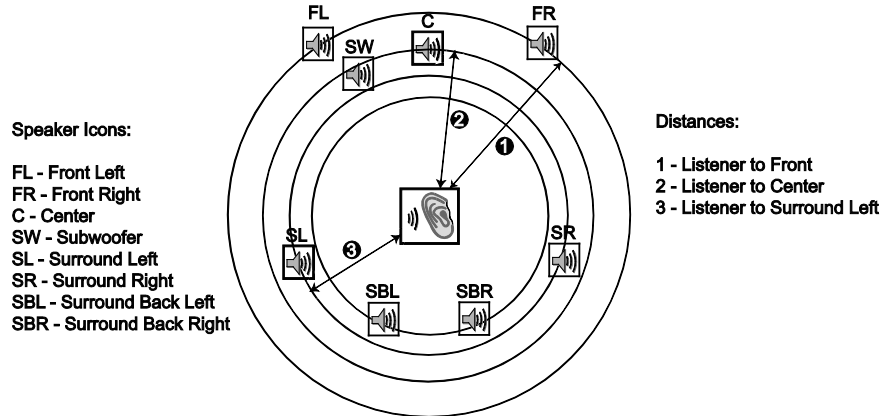

In the above diagram, measure the distance (in feet) from the primary listening position to the Front Left or Front Right Speaker. Enter the distance of the Front Speakers (❶ in the above picture) into the **Speaker Configuration** menu.

Next, measure the distance (in feet) from center speaker (❷) to the listening position. Move the cursor to highlight the Center speaker in the Channel Delay setup page, and enter the distance (as close as possible) in feet. Repeat for each speaker in the system (Center, Surround Left, Surround Right, Surround Back Left, Surround Back Right and Subwoofer) as available. The player will insert appropriate delay to make sure sound waves from different speakers arrive at the listener at the same time.

It is possible to independently set distances for each speaker. Speaker distances can be set to the actual spatial distance of the speakers.

If the channel delay settings cannot match your speaker configuration, please set all distances to the same and use your receiver/amplifier to set the channel delay.

3. **Trim:** The speaker trim level parameters sets the volume of each individual channel. Channel trim is generally not required since most A/V receivers have the capability to adjust channel trim and compensate for speaker sensitivity differences. However, if your receiver does not have such functions (many receivers do not support channel trim for their multi-channel analog inputs), you may adjust channel trim through the player. For most accurate results, it is recommended that you use test tones from a calibration disc, such as *Digital Video Essentials HD Basics*, and a SPL (Sound Pressure Level) meter. The trim level can be set to +/- 10dB in 0.5dB increments.

NOTE

- Increasing the **Trim Level** above 0dB may result in distortion if the original audio level is already high. When this occurs the waveform becomes clipped and audible distortion can be heard. In this situation, it is necessary to reduce the **Trim Level** until the distortion is removed. When using the **Trim Level** for speakers, it is recommended that you set the least sensitive speaker's **Trim Level** to 0dB, and set other speakers' **Trim Level** to negative values.
- Each speaker can be set to independent trim levels and there is no linked pair limitation.

Device Setup

The **Device Setup** section of the **Setup Menu** system allows you to configure additional player options related to the hardware and control functions.

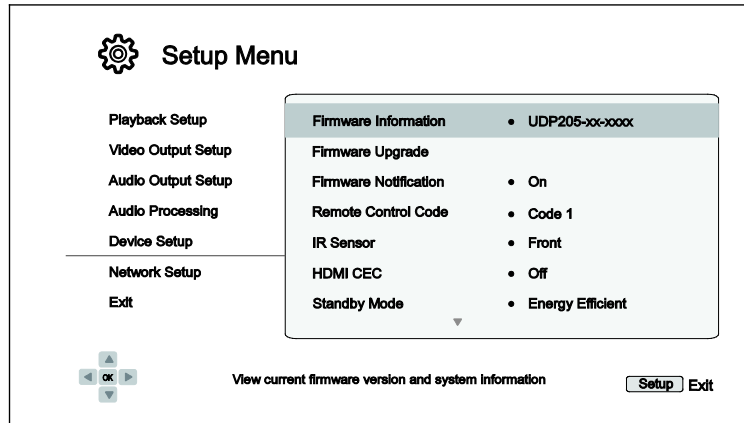

1. **Firmware Information:** Displays the currently installed firmware version.
2. **Firmware Upgrade:** Upgrades the player’s firmware. This operation is only available when the playback is completely stopped or when there is no disc loaded.

The firmware is the system software that controls the features and functions of the player. Since the Blu-ray Disc specifications are new and evolving, it is possible that a Blu-ray Disc manufactured after the player was manufactured uses certain new features of the Blu-ray Disc specifications. To ensure the best possible viewing experience, the player may need a firmware update from time to time. Please visit the OPPO Digital web site www.oppodigital.com to check for firmware updates and instructions on installing the updates.

There are three ways to upgrade the player’s firmware:

- **Via USB** – You may download the firmware files from the OPPO Digital web site to a USB drive and then use the USB drive to upgrade the player. Please follow the instructions on the firmware download web page.
 - **Via Disc** – You may request a firmware upgrade disc from OPPO Digital or download a disc image from the OPPO Digital web site and burn an upgrade disc. Please follow the instructions that come with the upgrade disc.
 - **Via Network** – If the player has a working Internet connection (see pages 19 and 76), you may upgrade the player directly over the Internet. Please follow the instructions on your TV screen.
3. **Firmware Notification:** Allows you to set whether the player should automatically check for new firmware versions on the Internet server and notifies you about new firmware.
 - **On** (default) – Checks for firmware updates automatically and notifies the user about new firmware. Requires a working network connection.
 - **Off** – Does not check for new firmware version automatically.
 4. **Remote Control Code:** The UDP-205 can respond to one of four sets of remote control codes. The default is “Code 1”. If you have other OPPO products in the vicinity of the UDP-205, the other products may respond to the UDP-205 remote control. To prevent this, you can select a different remote code. The available codes are:

- **Code 1** (default) – OPPO disc player remote code is set to 1. This is the default remote code.
- **Code 2** – OPPO disc player remote code is set to 2. Use this code if you have other OPPO products placed close to the UDP-205.
- **Code 3** – OPPO disc player remote code is set to 3. Use this code if you have other OPPO products placed close to the UDP-205.
- **Alt. Code** – Alternative remote code. The alternative remote control code enables users to program their universal remote controls that come with TV, projector or A/V receiver to operate the OPPO player. If the universal remote control has a DVD player control function, please program it with the code for Toshiba, Philips, Magnavox, Marantz or Zenith DVD players. Since each brand of remote control may have several sets of codes, you may need to try several times using different codes to find a working code.

If you have selected a new remote code, you must set the remote control handset to use the same code. If you have selected **Alt. Code**, the supplied handset will not operate the player, and you must use a universal remote control with the properly configured code set.

5. **IR Sensor:** The UDP-205 provides two IR sensors to allow you to set the UDP-205 to receive remote control signals from the front or the back.
 - **Front** (default) – Enables IR sensor on the front for receiving remote control signals.
 - **Back** – Enables IR sensor on the back for receiving remote control signals from an IR distribution system via an IR emitter or blaster.

6. **HDMI CEC:** Allows you to set the HDMI Consumer Electronics Control (CEC) mode. CEC is an optional HDMI feature that enables convenient remote control and automatic setup of consumer electronics over the HDMI connection. The remote control function allows you to use a single remote handset to operate multiple devices connected via HDMI. For example, you may use the TV remote to control playback of the Blu-ray Disc player. The automatic setup function can automatically turn on the TV and change to the proper input when you start playing a disc in the Blu-ray Disc player. It can also turn off the player automatically when you turn off the TV. The implementation and compatibility of this feature varies by device manufacturer. Each may only implement part of the features or add their own proprietary functions. The manufacturer-specific implementation of the HDMI CEC function is often given a proprietary name of "...Link" or "...Sync". The UDP-205 provides three HDMI CEC function modes for its HDMI Output (Main) port:
 - **Off** (default) – HDMI CEC feature is turned off on HDMI output terminal. The player will not respond to HDMI CEC commands from other devices, nor will it setup other devices automatically.
 - **On** – HDMI CEC is enabled on HDMI output. Use this mode if your other devices are compatible with the player.
 - **Limited** – HDMI CEC is enabled on HDMI output, but the UDP-205 will only respond to playback control commands. It will not respond or issue power on/off and input selection commands. Use this mode if you do not want the automatic setup function to turn on/off your devices.

7. **Standby Mode:** Allows you to choose between two standby modes. In **Energy Efficient** mode, the player consumes a minimal amount of power but takes more time to get ready for operation after being turned on. In **Network Standby** mode, the player can be woken up over the network and may start up faster at the expense of additional power consumption during the standby period.
 - **Energy Efficient** (default) – The player will take slightly longer to start up, but will consume less power in standby mode. This mode is recommended for regular use.

- **Network Standby** – This mode allows to wake the player in standby mode over the network. The player takes less time to start up but consumes more power in standby mode.
8. **Auto Power Off:** To allow the player to auto-shutdown after 30 minutes of inactivity. This can help reduce power consumption and prolong the service life of you player.
 - **On** – Enable the Auto Power Off.
 - **Off** (default) – Disable the Auto Power Off.
 9. **Sleep Timer:** Allows you to specify the amount of time before the player automatically turns itself off.
 - **Off** (default) – The player will not turn itself off automatically.
 - **30/45/60/90/120 Min** – After the specified time, the player automatically shuts itself down. You can press the **UP/DOWN ARROW** buttons and the **ENTER** button to select the desired time. Once selected, the remaining minutes will be displayed to the right of the “Sleep Timer” option.
 10. **Power On Input:** Allow you to set the initial input source after power on. It is recommended that you set this option only if you plan to use the player as a dedicated processor or per-amplifier.
 - **Blu-Ray** (default) – Power on with the regular Blu-ray Home Menu. This choice is recommended for regular use.
 - **Last Input** – Power on with the last input source. Depending on the availability of the input device, you may experience a blank screen on the display or “No signal” warning message.
 11. **Front Panel Brightness:** Allows you to control the display intensity of the front panel Vacuum Fluorescent Display (VFD) information window and the **Power** indicator light. If you feel that the display becomes a distraction to your enjoyment of the video, this option allows you to dim it or turn it off.
 - **Standard** (default) – The VFD window and the **Power** indicator light are at full brightness.
 - **Dim** – The VFD window and the **Power** indicator light are at reduced brightness.
 - **Off** – The VFD window is turned off and the **Power** indicator light is at dimmest brightness. In this mode, the display and indicator light will resume momentarily if there is any user operation.
 12. **Persistent Storage:** Allows you to manage the persistent storage for BD-Video content. The persistent storage is a data storage area that holds additional content for *BonusView* and *BD-Live* features. The data will be kept even if you turn off the player. The following persistent storage management options are available:
 - **Storage Device** – Allows you to select which storage device should be used as the persistent storage. There are also three USB ports on the player that can accept a USB drive to be used as the persistent storage. You may choose from the following:
 - **Internal Flash** – Uses the internal flash memory for persistent storage.
 - **USB Drive** – Uses a USB drive for persistent storage. To meet the specification for *BD-Live*, a USB flash drive of 1GB or larger is required. A USB hard drive is not recommended.

NOTE

- The new storage device choice becomes effective only after the player is restarted. Please make sure that you turn off the player and then turn it back on after changing the **Storage Device** option.

- **Space Used** – Displays the used space of the persistent storage. If too much space is used and the available space becomes too low, some Blu-ray Discs may not play properly.
- **Erase Persistent Storage** – Erases the BD-Video data from the persistent storage or initializes a USB drive so it can be used for persistent storage.

13. **Text to Speech:** Allows you to adjust Text to Speech settings.

- **Switch** – Allows you to enable and disable the player reading the text on screen when it is highlighted:
 - **On** – The text on screen will be read out when it is highlighted.
 - **Off** (default) – The text on screen will not be read out when it is highlighted.
- **Language** – Allows you to choose the language for reading the text on screen when it is highlighted. Currently the player supports English and Spanish. The default language is English.
- **Volume** – Allows you to set the volume of the voice for reading text on screen when it is highlighted. The default value is 100.
- **Pitch** – Allows you to set the pitch of the voice for reading text on screen when it is highlighted. The default value is 100.
- **Speed** – Allows you to set the speed of the voice for reading text on screen when it is highlighted:
 - **Very Slow / Slow / Normal / Fast / Very Fast** - These are the available speed of the voice for reading text on screen when it is highlighted. You can press the **UP/DOWN ARROW** buttons and the **ENTER** buttons to select it. The default speed is **Normal**.

14. **Settings Management:** Allows you to backup or restore the player settings. This option affects the settings in **Setup Menu**. It does not export/import private information such as WiFi password or account information.

- **Backup Settings** – Backup the player settings to the first detected USB storage device. The player will create a new configuration file named “[player model].cfg”, such as “UDP205.cfg”, and the settings will be stored in binary format which can only be accessed by OPPO technical support.
- **Restore Settings** – Restore the player’s settings from external USB storage. The player will access the first detected USB storage device for the configuration file. To avoid any confusion, we recommend only connect one USB storage device to the player at this time.

15. **Reset Factory Defaults:** To reset all settings to the factory default value. This operation also sets **BD-Live Network Access** to be **Off** (details on page 79) and performs **Erase Persistent Storage** (details on page 74). However, the remote control code, parental control password and ratings will not be reset. This operation is only available when the playback is completely stopped or when there is no disc loaded.

- **Erase Accounts and Settings** – Resets all settings to their factory default values and removes all account information.
- **Erase Settings** – Resets all settings to their factory default values, but keeps account information.

Network Setup

The **Network Setup** section of the **Setup Menu** system allows you to configure the player's network connection, test the connection, and enable or disable BD-Live access.

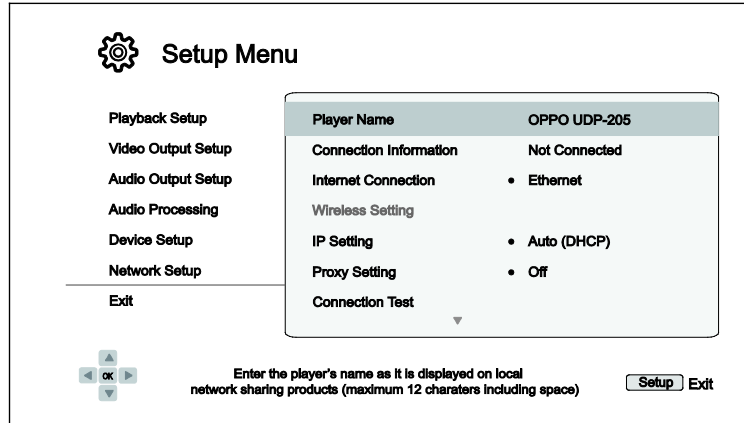

1. **Player Name:** Enter and display the player's identification name as it is displayed on local network sharing devices. To change it, press the **ENTER** button to bring up the virtual keyboard. The name can contain maximum 12 characters including spaces.
2. **Connection Information:** Displays the current internet connection information, such as connection type, IP address, Ethernet MAC, Wireless MAC, etc.
3. **Internet Connection:** Allows you to select the internet connection type.
 - **Ethernet** (default) – Connect to the internet through an Ethernet cable. Please refer to the connection instructions on page 21. Selecting this will disable the built-in wireless module and make the Wireless Setting option un-selectable.
 - **Wireless** – Connect to the internet through the built-in wireless module. Please refer to the connection instructions on page 22. Choosing **Wireless** will start the **Wireless Setup Assistant**, and will also make the **Wireless Setting** option in the next row selectable.
 - **Off** – Internet access is prohibited. This will make disable both the Ethernet and Wireless modules and makes Wireless Setting, IP Setting, Proxy Setting and Connection Test options un-selectable.
4. **Wireless Setting** – Start the **Wireless Setup Assistant**. You can start the **Wireless Setup Assistant** by selecting the **Wireless Setting** option, or by selecting **Wireless** in **Internet Connection** menu. The procedure is described as follows:

The player first searches for the previous wireless settings. If they exist, a message will pop up to remind you.

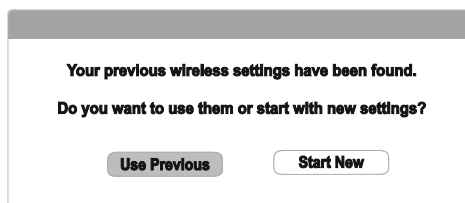

- **Use Previous** – Uses the previous wireless settings. A summary of the previous wireless settings will display, showing information such as the SSID (network name), Security Mode and Password.

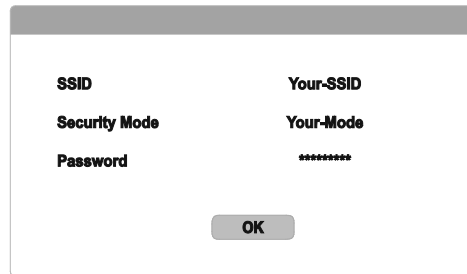

After verifying the previous settings, the player will test the connection and display the results.

- **Start New** – Creates a new wireless configuration. The UDP-205 supports three wireless configuration methods:

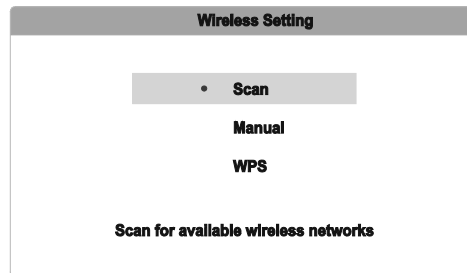

- **Scan** – Scans for an available wireless network. The player automatically scans for any available wireless networks and displays the search results in a window. You can press the **UP/DOWN ARROW** buttons to highlight a network and then press the **ENTER** button to select it. If this network is secured, you will need to input the password using the remote control. The player will then test the connection and display the results.
- **Manual** – Allows you to manually enter the information for a wireless network. You need to use the remote control to input the SSID, select the Security Mode and input the Password. The player will then test the connection and display the results.
- **WPS** – Starts the Wi-Fi Protected Setup. The UDP-205 supports the WPS standard to provide an easy and secure establishment of a wireless home network. Configures the WPS using a PIN (Personal Identification Number). The UDP-205 will generate a PIN code and you will need to input it into the software control panel of your wireless router or access point. Please follow the on-screen instructions.

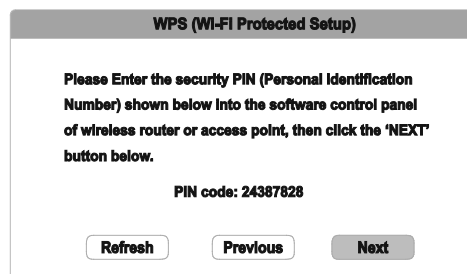

NOTE

- **SSID** is short for Service Set Identifier. It is an identifier for each wireless router or access point, and is also referred to as a **network name**.
- **WPS** is short for Wi-Fi Protected Setup (WPS). It is the latest standard for easy and secure wireless home network configuration. It is also named **Wi-Fi Simple Config**. To use WPS, a WPS compatible router or access point is required.

5. **IP Setting:** Determines how the player obtains its IP address.

- **Auto (DHCP)** – The player automatically obtains its IP address information using DHCP (Dynamic Host Configuration Protocol). This is the default setting. In most cases, automatic IP configuration should be used.
- **Manual** – Allows you to manually enter the numeric IP address. Set the IP configuration manually only when the router has no DHCP server functions or when the router’s DHCP server function is disabled. For more information on how to manually configure the Internet connection and what values to use, please consult your broadband router/modem instruction manuals or call your Internet service provider.
 - **Internet Connection** – Depending on the setting in **Internet Connection**, this can be either “Wireless” or “Ethernet”.
 - **IP Address:** The Internet Protocol address of the player. When **IP Setting** is set to **Auto (DHCP)**, the value displayed here is obtained using DHCP and cannot be changed.
 - **Subnet Mask:** Each IP address has an associated subnet mask. It is used by the player to decide whether to route network traffic through the router or directly to another device on the same network. When **IP Setting** is set to **Auto (DHCP)**, the value displayed here is obtained using DHCP and cannot be changed.
 - **Gateway:** The IP address of the router. It is also called “default gateway” or “default router”. When **IP Setting** is set to **Auto (DHCP)**, the value displayed here is obtained using DHCP and cannot be changed.
 - **DNS 1:** The IP address of the primary DNS (Domain Name System) server. DNS is the mechanism used to translate human-readable addresses (such as www.oppodigital.com) to numeric IP addresses. When **IP Setting** is set to **Auto (DHCP)**, the value displayed here is obtained using DHCP and cannot be changed.
 - **DNS 2:** The IP address of the secondary DNS server. When **IP Setting** is set to **Auto (DHCP)**, the value displayed here is obtained using DHCP and cannot be changed.

6. **Proxy Setting:** Allows you to configure the proxy server settings. The proxy server works as an intermediary for network communication between clients and other servers, which can provide benefits like security, anonymity, or even circumvention of regional restrictions.

- **On** – Accesses the Internet via a proxy server.
 - **Proxy Host:** Input the proxy host name using the remote control.
 - **Proxy Port:** Input the proxy host port number using the remote control.
- **Off (default)** – Disables the use of a proxy server.

We recommend keeping **Proxy Setting** set to **Off**, unless you have a working Proxy Host and Proxy Port, and have to use the proxy server in order to access the internet.

7. **Connection Test:** Allows you to test the Internet connection. It is recommended that you test the connection when you initially connect the player to the Internet, or whenever changes to **Connection Method, Wireless Setting, IP Setting** and other network parameters are made.

8. **BD-Live Network Access:** Used to permit or restrict BD-Live content access.
 - **On** – BD-Live access is permitted.
 - **Limited** – BD-Live access is permitted only for content that has a valid content owner certificate. Internet access is prohibited if the BD-Live content does not have a certificate. This option ensures that you are accessing only authentic content, although it may block your access to smaller independent content providers.
 - **Off** (default) – BD-Live access is prohibited.

9. **My Network:** Configures the My Network (in-home media sharing) client. My Network enables the player to stream audio, video, and photos from media servers within the home network.
 - **On** (default) – Enables local network streaming. A broadband internet connection is required (details on page 19), and special hardware/software configurations are required. The available media servers are listed inside the **Network** option of the **Home Menu**.
 - **Off** – Disables local network streaming. No media servers will be shown in the **Network** menu, and a warning message will pop up once you try to enter the **Network** menu.

10. **IP Control:** Configure IP control functions over the network.
 - **On** (default) – Enable IP control.
 - **Off** – Disable IP control.

Useful Notes

- In order to prolong the life of your player, it is recommended that you wait at least 30 seconds before you power it on after switching it off.
- Remove discs and turn the power off after operation.
- Some functions of the player may not be applicable to certain discs.
- Some discs with special features may not be fully supported by the player. This is not a malfunction of the unit.
- In the case of player malfunction, please turn it off, wait for 30 seconds and turn it back on. If the problem still exists, please follow the troubleshooting instructions or contact an OPPO service center.

Troubleshooting

Use this chart to resolve general operational problems. If there are any problems that you cannot resolve, please contact your OPPO service center.

Symptom	Possible Cause	Solution	Reference Page
No sound	Audio cable is not properly connected	Check audio cable, and then reconnect if necessary.	12–18
	Mute is activated	Press the MUTE button to cancel the mute.	28
	Volume is too low	Press the VOL+ button to increase the volume to 100.	28
	SACD is played and the audio connection is coaxial or optical digital audio	This is not supported due to copyright restrictions of SACD. Please use the analog or HDMI audio output. Alternatively, you may set SACD Priority to CD mode and the player will play the CD layer.	18, 60
	DVD-Audio is played and the audio connection is coaxial or optical digital audio	This is not supported due to copyright restrictions of DVD-Audio. Please use the analog or HDMI audio output. Alternatively, you may switch to the DVD-Video playback mode.	18, 60
No picture	Video cable is not properly connected	Check video cable; reconnect if necessary.	12–14
	TV input is not correctly selected	Select the input to which the player is connected.	
	“Pure Audio” mode engaged	Press the PURE button to cancel this mode.	38
	Video output format is not supported by the TV	Select a proper output resolution that is supported by your TV.	57

No color	Saturation set too low	Check the saturation setting on TV and player.	56
Incorrect color	Incorrect color space setting	If using HDMI for video output, check the color space setting on the TV and player.	54
"No Disc" or "Unknown Disc" error	No disc or incompatible disc loaded in player	Eject disc and check.	24
	Dirty disc recording surface	Eject the disc and clean any dirt or fingerprints.	4
	Disc not properly loaded	Eject disc and make sure the label side is facing up and the record side is facing down.	24
	Condensation on the laser pick-up head	Turn on the player, eject the disc and leave the player on for about an hour.	2
Remote control failure	Remote control is out of range	Use the remote control within the effective range.	9
	Low battery	Replace the batteries	9
	Incorrect remote control code	Open the disc tray. Aim the remote at the player. Press and hold the ENTER button on the remote for 5 seconds to set the remote code.	10
Temporary function failure	Scratched or damaged disc is used	Replace the disc.	24
	Some functions are not available during playback	Stop playback completely, then try again.	24
	Interference from other devices	Identify interference by turning off other devices, and then relocate or replace the offending device	2
Some Setup Menu items are grayed out	Some setup options cannot be changed while a disc is playing. Some setup options may be mutually exclusive with other setup options.	Fully stop playback, eject the disc and try the Setup Menu again.	46
"Connection Test" fails	No internet connection.	Verify that your router has a connection to the internet. Try power cycling the modem and router. Try a direct Ethernet connection if possible.	21, 76
"Network" shows no server	No network connection. Media server not properly configured. Connected to wrong network.	Verify that other network features are functional on the device. If the network issues are isolated to the "Network" feature, consult your media server's documentation to ensure proper configuration.	21, 76

Specifications

Designs and specifications are subject to change without notice.

Disc Types*	UHD Blu-ray, Blu-ray, Blu-ray 3D, DVD-Video, DVD-Audio, AVCHD, SACD, CD, Kodak Picture CD, CD-R/RW, DVD±R/RW, DVD±R DL, BD-R/RE
BD Profile	BD-ROM Version 3.1 Profile 6 (also compatible with BD-ROM Version 2.5 Profile 5)
Output	Analog Audio: 7.1ch, 5.1ch, stereo. Dedicated Stereo Analog Audio: XLR balanced, RCA single-ended. Coaxial/Optical Audio: up to 2ch/192kHz PCM, Dolby Digital, DTS. HDMI Audio: up to 7.1ch/192kHz PCM, up to 5.1ch DSD, Bitstream. HDMI Video: UHD/1080p24/1080p/1080i/720p/576p/576i/480p/480i, 3D frame-packing 1080p24/720p.
Input	HDMI Audio: up to 7.1ch/192kHz PCM, up to 5.1ch DSD, Bitstream. HDMI Video: UHD/1080p24/1080p/1080i/720p/576p/576i/480p/480i, 3D frame-packing 1080p24/720p. USB Audio: up to 2ch/768kHz PCM, up to 2ch/2.8224MHz/5.6448MHz/11.2896MHz DSD. Coaxial/Optical Audio: up to 2ch/192kHz PCM, Dolby Digital, DTS, AAC.
Analogue Audio Characteristics** (Stereo Audio Output)	Frequency Response: 20Hz – 160kHz (-3dB ~ +0.05dB) Signal-to-Noise Ratio: > 120dBr THD+N: < 0.00018% Output Level: (RCA) 2.1±0.2Vrms. (XLR) 4.2±0.4Vrms Dynamic Range: > 120dB Crosstalk: > 118dB
Analogue Audio Characteristics** (Multi-channel Audio Output)	Frequency Response: 20Hz – 160kHz (-3dB ~ +0.05dB) Signal-to-Noise Ratio: > 120dBr THD+N: < 0.00031% Output Level: 2.1±0.2Vrms Dynamic Range: > 120dB Crosstalk: > 118dB
Headphone Audio Characteristics**	Frequency Response: 20Hz – 80kHz (-2dB ~ +0.05dB) into 32ohm Signal-to-Noise Ratio: > 105dBr into 32ohm THD+N: < 0.01% into 32ohm and 50mW Maximum Output Power: 590mW into 32ohm Dynamic Range: > 115dB into 32ohm Output Impedance: < 0.1ohm
General Specification	Power Supply: 110V – 120V ~ / 220V – 240V ~, 50/60Hz AC Power Consumption: 65W (Standby: 0.5W in Energy Efficient Mode) Dimensions: 16.8 x 12.2 x 4.8 inches (430mm x 311mm x 123mm) Mass: 22lbs (10kg)
Operating Temperature	41°F – 95°F 5°C – 35°C
Operating Humidity	15% – 75% No condensation

* Compatibility with user-encoded contents or user-created discs is on a best effort basis with no guarantee due to the variation of media, software and techniques used.

**Nominal specification.

User Manual Updates Online

An updated version of the User Manual may be available online at the OPPO Digital web site www.oppodigital.com. To read or download the latest online User Manual, please visit the product support page for the UDP-205 model.

Occasional updates are needed to reflect new features added to the player since the User Manual was printed. As future firmware updates brings in new features and functions, the online version of the User Manual will be updated accordingly.

Language Code List

Code	Language Name	Code	Language Name	Code	Language Name
6565	Afar	7285	Hungarian	8084	Portuguese
6566	Abkhazian	7289	Armenian	8185	Quechua
6570	Afrikaans	7365	Interlingua	8277	Rhaeto-Romance
6577	Amharic	7378	Indonesian	8279	Romanian
6582	Arabic	7383	Icelandic	8285	Russian
6583	Assamese	7384	Italian	8365	Sanskrit
6588	Aymara	7387	Hebrew	8368	Sindhi
6590	Azerbaijani	7465	Japanese	8372	Serbo-Croatian
6665	Bashkir	7473	Yiddish	8373	Singhalese
6669	Byelorussian	7487	Javanese	8375	Slovak
6671	Bulgarian	7565	Georgian	8376	Slovenian
6672	Bihari	7575	Kazakh	8377	Samoaan
6678	Bengali, Bangla	7576	Greenlandic	8378	Shona
6679	Tibetan	7577	Cambodian	8379	Somali
6682	Breton	7578	Kannada	8381	Albanian
6765	Catalan	7579	Korean	8382	Serbian
6779	Corsican	7583	Kashmiri	8385	Sundanese
6783	Czech	7585	Kurdish	8386	Swedish
6789	Welsh	7589	Kirghiz	8387	Swahili
6865	Danish	7665	Latin	8465	Tamil
6869	German	7678	Lingala	8469	Telugu
6890	Bhutani	7679	Laothian	8471	Tajik
6976	Greek	7684	Lithuanian	8472	Thai
6978	English	7686	Latvian, Lettish	8473	Tigrinya
6979	Esperanto	7771	Malagasy	8475	Turkmen
6983	Spanish	7773	Maori	8476	Tagalog
6984	Estonian	7775	Macedonian	8479	Tonga
6985	Basque	7776	Malayalam	8482	Turkish
7065	Persian	7778	Mongolian	8484	Tatar
7073	Finnish	7779	Moldavian	8487	Twi
7074	Fijian	7782	Marathi	8575	Ukrainian
7079	Faroese	7783	Malay	8582	Urdu
7082	French	7784	Maltese	8590	Uzbek
7089	Frisian	7789	Burmese	8673	Vietnamese
7165	Irish	7865	Nauru	8679	Volapuk
7168	Scots Gaelic	7869	Nepali	8779	Wolof
7176	Galician	7876	Dutch	8872	Xhosa
7178	Guarani	7879	Norwegian	8979	Yoruba
7185	Gujarati	7982	Oriya	9072	Chinese
7265	Hausa	8065	Panjabi	9085	Zulu
7273	Hindi	8076	Polish		
7282	Croatian	8083	Pashto, Pushto		

RS-232 Control Protocol

The OPPO UDP-205 is equipped with an RS-232 port for wired remote control. The RS-232 port is configured as a DCE device using a female 9-pin D-Sub type connector.

RS-232 Pin Configuration:

The pin out of the UDP-205 RS-232C port is as the following:

Pin	2	3	5
Signal	TXD	RXD	GND

This pin configuration allows a PC running a serial terminal program (such as Hyper Terminal) to communicate with the player using a straight-through DB9 9-pin RS-232 serial cable. Do NOT use a "Null-Modem" type cable for PC connection. For connection to a remote control system, please refer to the documentation that comes with the remote control system.

Communication Settings:

Baud Rate	Data Bits	Parity	Stop Bit	Flow Control
9600	8	None	1	None

Command Structure:

Each command starts with a # sign (ASCII 0x23), followed by a 3-character command code. If there are any parameters for the command, the parameters are given in text format, separated by a space (ASCII 0x20) from the command code. The # character (ASCII 0x23) must never appear in the parameters. A carriage return (ASCII 0x0d) indicates the end of the command. A line feed (ASCII 0x0a) can optionally follow the carriage return and will be ignored. Each command generally may not exceed 25 bytes including the start of command and end of command bytes.

The illustration of the command structure is as the followings:

<Command> = <Start of Command><Command Code>[<sp><Parameters>]<End of Command>
<Start of Command> = #, ASCII 0x23
<Command Code> = <byte><byte><byte>
<sp> = space, ASCII 0x20
<Parameters> = command-specific
<End of Command> = CR, ASCII 0x0d[LF, ASCII 0x0a]

Response Structure:

Upon receiving a command, the player shall try to execute the command and send back a response. The response starts with an "@" sign (ASCII 0x23), followed by the original command code and a space (ASCII 0x20), and a result code, either "OK" or "ER". If there are any parameters or additional message, the parameters or message is given in text format, separated by a space (ASCII 0x20) from the result code. The @ character (ASCII 0x40) must never appear in the parameters or message. A carriage return (ASCII 0x0d) indicates the end of response. Each response generally may not exceed 25 bytes including the start of response and the end of response bytes.

The illustration of the response structure is as the followings:

<Response> = <Start of Response><Command Code><sp><Result Code>
 [<sp><Parameters>]<End of Response>
 <Start of Response> = @, ASCII 0x40
 <Command Code> = <byte><byte><byte>
 <Result Code> = OK|ER
 <sp> = space, ASCII 0x20
 <Parameters> = command-specific
 <End of Response> = CR, ASCII 0x0d

Status Update Messages Structure:

If the verbose mode is set to 2 or 3, the player will send status update messages automatically. These messages are not a response to any particular command. Any status change caused by commands from RS232 control, front panel buttons, IR remote control, or playback progress may trigger status update messages.

The status update messages have the following structure:

<Update> = <Start of Update><Status Code>[<sp><Parameters>]<End of Update>
 <Start of Update> = @, ASCII 0x40
 <Status Code> = <byte><byte><byte>
 <sp> = space, ASCII 0x20
 <Parameters> = status-specific
 <End of Response> = CR, ASCII 0x0d

Command Sequence:

Commands are executed in the order they are received. The control client should wait for a response from the player before sending the next command.

If the player receives a new command before executing the previous command, the player may execute the commands in sequence or discard the previous command, depending on the internal processing of the player. The control client should avoid sending multiple commands in sequence without waiting for a response.

If the host does not receive a response from the player 10 seconds after the command is issued, the host may consider the command or response lost during transmission, and can retransmit the command.

Command List:

A. Command that maps to a remote control button

This group of commands maps directly to the infrared remote control keys. No parameters are needed for these commands. The player handles the commands as if it receives the same IR remote commands. For actions that require a multiple-key sequence, such as go to a certain chapter (GOT command followed by multiple numeric key commands and the SEL command), the player responds to each command individually until the last command is received. At that time the player shall respond with either OK or ER depending on the result of the action.

Command Code	Remote Key	Function	Response Example
POW	POWER	Toggle power STANDBY and ON	OK ON OK OFF
SRC	INPUT	Switch input source	OK

EJT	OPEN	Open/close the disc tray	OK OPEN OK CLOSE
PON	ON	Discrete on	OK ON
POF	OFF	Discrete off	OK OFF
DIM	DIMMER	Dim front panel display	OK ON OK DIM OK OFF
PUR	PURE AUDIO	Pure audio mode (no video)	OK ON OK OFF
VUP	VOL +	Increase volume	OK n (n is the volume number, 0 – 100)
VDN	VOL -	Decrease volume	OK n (n is the volume number, 0 – 100)
MUT	MUTE	Mute audio	OK MUTE OK UNMUTE
NU1	1	Numeric key 1	OK
NU2	2	Numeric key 2	OK
NU3	3	Numeric key 3	OK
NU4	4	Numeric key 4	OK
NU5	5	Numeric key 5	OK
NU6	6	Numeric key 6	OK
NU7	7	Numeric key 7	OK
NU8	8	Numeric key 8	OK
NU9	9	Numeric key 9	OK
NU0	0	Numeric key 0	OK
CLR	CLEAR	Clear numeric input	OK
GOT	GOTO	Play from a specified location	OK
HOM	HOME	Go to Home Menu to select media source	OK
PUP	PAGE UP	Show previous page	OK
PDN	PAGE DOWN	Show next page	OK
OSD	DISPLAY	Show/hide on-screen display	OK
TTL	TOP MENU	Show BD top menu or DVD title menu	OK
MNU	POP-UP MENU	Show BD pop-up menu or DVD menu	OK
NUP	Up Arrow	Navigation	OK
NLT	Left Arrow	Navigation	OK
NRT	Right Arrow	Navigation	OK
NDN	Down Arrow	Navigation	OK
SEL	ENTER	Navigation	OK
SET	SETUP	Enter the player setup menu	OK
RET	RETURN	Return to the previous menu or mode	OK
RED	RED	Function varies by content	OK
GRN	GREEN	Function varies by content	OK
BLU	BLUE	Function varies by content	OK
YLW	YELLOW	Function varies by content	OK
STP	STOP	Stop playback	OK
PLA	PLAY	Start playback	OK
PAU	PAUSE	Pause playback	OK
PRE	PREV	Skip to previous	OK
REV	REV	Fast reverse play	OK 1X
FWD	FWD	Fast forward play	OK 1X

NXT	NEXT	Skip to next	OK
AUD	AUDIO	Change audio language or channel	OK
SUB	SUBTITLE	Change subtitle language	OK
ANG	ANGLE	Change camera angle	OK a/b (a: current angle number, b: total available angles)
ZOM	ZOOM	Zoom in/out and adjust aspect ratio	OK (zoom ratio text)
SAP	SAP	Turn on/off Secondary Audio Program	OK (audio track information) OK Off
ATB	AB REPLAY	Repeat play the selected section	OK A- OK A-B OK OFF
RPT	REPEAT	Repeat play	OK Repeat Chapter OK Repeat Title OK OFF
PIP	PIP	Show/hide Picture-in-Picture	OK (PIP program info) OK Off
HDM	RESOLUTION	Switch output resolution	OK
SUH	SUBTITLE (hold)	Press and hold the SUBTITLE key. This activates the subtitle shift feature	OK
OPT	OPTION	Show/hide the Option menu	OK
M3D	3D	Show/hide the 2D-to-3D Conversion or 3D adjustment menu	OK
SEH	PIC	Display the Picture Adjustment menu	OK
HDR	HDR	Display the HDR selection menu	OK
INH	DISPLAY (hold)	Show on-screen detailed information	OK
RLH	RESOLUTION (hold)	Set resolution to Auto (default)	OK
AVS		Display the A/V Sync adjustment menu	OK
GPA		Gapless Play. The function same as select Gapless Play in Option Menu when it available	OK
NOP		No operation.	OK

B. Query Commands

This group of commands issues queries to the player. The player shall respond according to its current status.

Command Code	Function	Response Example
QVM	Query verbose mode	OK 0 OK 1 OK 2 OK 3

QPW	Query power status	OK ON OK OFF
QVR	Query firmware version	OK UDP205-xx-xxxx
QVL	Query volume	OK 100 OK MUTE
QHD	Query HDMI resolution	OK 480P OK 720P50 OK 1080P60 OK AUTO OK 4K*2K
QPL	Query playback status	OK NO DISC OK LOADING OK OPEN OK CLOSE OK PLAY OK PAUSE OK STOP OK STEP OK FREV OK FFWD OK SFWD OK SREV OK SETUP OK HOME MENU OK MEDIA CENTER
QTK	Query Track/Title	OK 02/10
QCH	Query Chapter	OK 03/03
QTE	Query Track/Title elapsed time	OK 00:01:34
QTR	Query Track/Title remaining time	OK 01:20:23
QCE	Query Chapter elapsed time	OK 00:01:34
QCR	Query Chapter remaining time	OK 00:12:22
QEL	Query Total elapsed time	OK 00:05:12
QRE	Query Total remaining time	OK 01:34:44
QDT	Query disc type	OK UHBD OK BD-MV OK DVD-VIDEO OK DVD-AUDIO OK SACD OK CDDA OK DATA-DISC
QAT	Query audio type	OK DD 1/1 OK DD 1/5 English OK DTS 2/5 English OK LPCM OK DTS-HD 1/4 English
QST	Query subtitle type	OK OFF OK 1/1 English
QSH	Query subtitle shift	OK -10 (valid returns are -10 .. 0 .. 10)
QOP	Query OSD position	OK 0 (valid returns are 0 .. 5)
QRP	Query Repeat Mode	OK 00 Off (OK followed by a repeat mode code and text: 00 Off

		01 Repeat One 02 Repeat Chapter 03 Repeat All 04 Repeat Title 05 Shuffle 06 Random)
QZM	Query Zoom Mode	OK 00 (OK followed by a zoom mode code: 00 Off 01 Stretch 02 Full 03 Underscan 04 1.2x 05 1.3x 06 1.5x 07 2x 08 3x 09 4x 10 1/2 11 1/3 12 1/4)
QHR	Query HDR Setting	OK Auto OK On OK Off

C. Advanced Commands

This group of commands instructs the player to perform an advanced operation in a single step.

Command Code	Parameters	Function	Response Example
SVM	0 1 2 3	0 – Set Verbose Mode to off 1 – Not in use (for backwards compatibility) 2 – Enable unsolicited status update. Only major status changes are reported. 3 – Enable detailed status update. When content is playing, the player sends out playback time update every second.	OK 0 OK 1 OK 2 OK 3
SIS	0 1 2 3 4 5	Select the input source: 0 – Blu-Ray Player 1 – HDMI INPUT 2 – ARC-HDMI-OUT 3 – OPTICAL IN 4 – COAXIAL IN 5 – USB AUDIO IN	OK 0 OK 1 OK 2 OK 3 OK 4 OK 5
SHD	AUTO SRC UHD_AUTO UHD24 UHD50 UHD60 1080P_AUTO 1080P24	Set HDMI output resolution. If a custom resolution parameter is given, this command changes the “Custom Resolution” setting in the setup menu and sets the “Output Resolution” to “Custom” at the same time.	OK 480P (OK followed by the original parameter)

	1080P50 1080P60 1080I50 1080I60 720P50 720P60 576P 576I 480P 480I		
SZM	1 AR FS US 1.2 1.3 1.5 2 1/2 3 4 1/3 1/4	Set zoom ratio. AR – Aspect ratio correction (Stretch, Letterbox or Pillarbox) FS – Full Screen US – Under scan 1, 1.2, 1.3, 1.5, 2, 1/2 – Specified zoom ratio.	OK 1.2 (OK followed by the zoom ratio) ER INVALID
SVL	0 – 100 MUTE	Set volume control	OK 100 OK MUTE
SRP	CH TT ALL OFF SHF RND	Repeat chapter Repeat title or CD track Repeat all Repeat off Shuffle Random	OK CH (OK followed by the repeat mode) ER INVALID
SRH	T3 C10 C 0:00:34 T 0:12:13 0:12:13	Search to Title 3 Search to Chapter 10 Search to 0:00:34 of the current chapter or track Search to 0:12:13 of the current title or disc Search to 0:12:13 of the current title or disc	OK ER INVALID
DPL		Direct play	OK
RST		Reset Command – Clean all command buffers, do not wait for any pending/executing commands. Start over again.	OK
SSH	-10 ... 10	Set subtitle shift	OK -10 (OK followed by the shift level) ER INVALID
SOP	0 ... 5	Set OSD position	OK 5 (OK followed by the position value) ER INVALID
STC	E R T X C	Set the time information display: E – Total Elapsed time R – Total Remaining time T – Title Elapsed time X – Title Remaining time	OK E (OK followed by the display type) ER INVALID

	K	C – Chapter/track Elapsed time K – Chapter/track Remaining time	
SHR	Auto On Off	Set HDR setting	OK Auto

Status Update Messages:

The following status update messages are sent by the player automatically when the verbose mode is set to 2 or 3.

A. Verbose Mode 2:

UPW - Power Status Update:

Sent when there is a change of power on/off status.

Possible parameters: 1 digit

1 – Player is turned on

0 – Player is going off

Example: UPW 1

UPL - Playback Status Update:

Sent when there is a change of playback status.

Possible Parameters: 4 chars

DISC – No disc

LOAD – Loading disc

OPEN – Tray is open

CLOS – Tray is closing

PLAY – Playback is starting

PAUS – Playback is paused

STOP – Playback is stopped

STPF – Forward frame-by-frame step mode

STPR – Reverse frame-by-frame step mode

FFWn – Fast forward mode. Where n is a number of 1... 5 to indicate the speed level

FRVn – Fast reverse mode. Where n is a number of 1... 5 to indicate the speed level

SFWn – Slow forward mode. Where n is a number of 1...4 to indicate the speed level (1 = 1/2, 2 = 1/4, 3 = 1/8, 4 = 1/16)

SRVn – Slow reverse mode. Where n is a number of 1...4 to indicate the speed level (1 = 1/2, 2 = 1/4, 3 = 1/8, 4 = 1/16)

HOME – in home menu

MCTR – in media center

Example: UPL PLAY

UVL - Volume Level Update:

Sent when there is a change in volume level or mute status.

Possible Parameters: 3 chars

MUT – Mute is engaged

000 .. 100 – Current volume level. Also sent when mute is cancelled.

Example: UVL 095

UDT - Disc Type Update:

Sent when a new disc type is detected.

Possible Parameters: 4 chars

UHBD – Ultra HD Blu-ray Disc

BDMV – Blu-ray Disc
DVDV – DVD-Video
DVDA – DVD-Audio
SACD
CDDA
DATA – Data disc
VCD2 – VCD 2.0
SVCD – SVCD

Example: UDT DVDV

UAT - Audio Type Update:

Sent when a new audio track is encountered.

Parameters: Type (2 chars), space, number (01/99, 5 chars), space, language (3 chars), space, channels (2 chars)

Type code:

DD – Dolby Digital
DP – Dolby Digital Plus
DT – Dolby TrueHD
TS – DTS
TH – DTS-HD High Resolution
TM – DTS-HD Master Audio
PC – LPCM
MP – MPEG Audio
CD – CD Audio
UN – Unknown

Number: current audio track / available audio tracks in 2-digit number format. For example, 01/99 means the first of 99 available tracks; 02/05 means the second of 5 available tracks. If only one track is available, it is 01/01.

Language: Three-character language code: ENG for English, FRA for French, and so on (ISO3166). UNK for unknown.

Channels: 1.0 for mono, 2.0 for stereo, 5.1 or 7.1 for 5.1-channel or 7.1-ch surround, 0.0 for unknown.

Example: UAT DD 01/05 ENG 5.1

UST - Subtitle Type Update:

Sent when a new subtitle is selected.

Parameters: number (01/99, 5 chars), space, language (3 chars)

Number: current subtitle track / available subtitle tracks in 2-digit number format. For example, 01/99 means the first of 99 available tracks; 02/05 means the second of 5 available tracks. If subtitle is set to off, use 00/xx where xx is the number of available subtitle tracks. If no subtitle is available, use 00/00.

Language: Three-character language code: ENG for English, FRA for French, and so on (ISO3166). UNK for unknown.

Example: UST 02/05 ENG

B. Verbose Mode 3:

UTC - Time Code Update:

Sent every second when the playback time advances. The time information is the same as the front panel display. To switch to a different type of time information, please refer to the STC command.

Parameters: Title (3 digits), space, Chapter (3 digits), space, Type (1 char), space, time (8 chars HH:MM:SS)

Title: Current title number. For example, 001. For discs without title numbers (CD), 001 is always used.

Chapter: Current chapter or track number. For example, 003.

Type Code:

- E – Total Elapsed time
- R – Total Remaining time
- T – Title Elapsed time
- X – Title Remaining time
- C – Chapter/track Elapsed time
- K – Chapter/track Remaining time

Example: UTC 001 001 C 00:01:23

UVO - Video Resolution Update:

Sent when the source content resolution or the output resolution is changed.

Parameters: Source resolution (7 chars), space, Output resolution (7 chars)

Resolution Names:

- _480I60 – 480i 60/59.94Hz
- _480P60 – 480p 60/59.94Hz
- _576I50 – 576i 50Hz
- _576P50 – 576p 50Hz
- _720P60 – 720p 60/59.94Hz
- _720P50 – 720p 50Hz
- 1080I60 – 1080i 60/59.94Hz
- 1080I50 – 1080i 50Hz
- 1080P60 – 1080p 60/59.94Hz
- 1080P50 – 1080p 50Hz
- 1080P24 – 1080p 24Hz
- 1080P23 – 1080p 23.97Hz
- UHD_P24– UHD 24Hz
- UHD_P23 – UHD 23.97Hz
- UHD_L60 – UHD 60Hz/59.94Hz
- UHD_L50 – UHD 50Hz

LIMITED WARRANTY

OPPO Digital, Inc. Limited Two Years Warranty

Your OPPO product has been manufactured to precise standards, and with rigid quality control through every process of manufacturing. It is warranted by OPPO DIGITAL, INC. against defective workmanship or materials for two (2) full years from the original date of purchase. This warranty applies only to OPPO brand products imported or manufactured by OPPO Digital, Inc. and sold to the original consumer purchaser in the U.S.A. or Canada by either OPPO Digital, Inc. or an OPPO authorized reseller. This warranty does not apply to OPPO brand products imported and sold by unauthorized dealers, distributors, or other sellers. This warranty does not apply to products purchased or shipped outside of the U.S.A. and Canada. OPPO Digital, Inc. may at its sole discretion, refuse to honor the warranty of any such unauthorized product that may be presented for service.

Warranty service can only be performed by OPPO Digital, Inc. or an OPPO authorized service center. The original dated bill of sale must be presented upon request as proof of purchase.

OPPO Digital, Inc. will, at its option and at no charge as stipulated herein, repair or replace product which is returned either in person or postpaid and insured to an OPPO service center, with new or reconditioned parts or products. Replacement parts and products assume the remaining original warranty, or ninety (90) days, whichever is longer.

This limited warranty covers noncommercial use of this product, and shall not apply to the following, including, but not limited to: applications and uses for which this product was not intended; altered product or serial numbers; cosmetic damage or exterior finish; batteries and cable accessories; accidents, abuse, neglect, fire, water, lightning or other acts of nature; incorrect electrical line voltage, fluctuations and surges; failure to follow operating or maintenance instructions. OPPO Digital, Inc. does not warrant uninterrupted or error-free operation of the product. This limited warranty shall not extend to anyone other than the original purchaser of the product. It is nontransferable and states your exclusive remedy.

THE FOREGOING WARRANTY IS THE ONLY WARRANTY WITH RESPECT TO THE PRODUCT AND OPPO DIGITAL, INC. MAKES NO OTHER WARRANTY WHATSOEVER, EXPRESS OR IMPLIED, REGARDING THE PRODUCT INCLUDING MERCHANTABILITY AND FITNESS FOR A PARTICULAR PURPOSE. IN NO EVENT WILL OPPO DIGITAL, INC. OR ITS AUTHORIZED RESELLERS BE LIABLE FOR INCIDENTAL, CONSEQUENTIAL OR SPECIAL DAMAGES, EVEN IF SUCH DAMAGES RESULT FROM NEGLIGENCE OR OTHER FAULT.

Some states do not allow limitation on how long an implied warranty lasts, or the exclusion or limitation of incidental or consequential damages, so the above limitations or exclusions may not apply to you. This warranty gives you specific legal rights, and you may also have other rights which vary from state to state.

TO REGISTER YOUR PURCHASE FOR WARRANTY, please visit the following Web site:

<http://www.oppodigital.com/registration.asp>

TO OBTAIN WARRANTY SERVICE, please follow these instructions:

- Contact OPPO customer service via email at service@oppodigital.com with details of the defect claimed, product model, serial number, date and place of the original purchase.

- If it is determined that your product needs service, a Return Merchandise Authorization (RMA) number will be issued to you along with return instructions and address of an OPPO service center.
- Pack the product securely, preferably in the original packaging, with your assigned RMA number marked clearly on the outside of the package. Send the package postpaid and insured to the OPPO service center to obtain warranty service.

Thank you for choosing OPPO. Your satisfaction is our highest priority.

OPPO Digital Inc.
162 Constitution Dr.
Menlo Park, CA 94025, U.S.A.
www.oppodigital.com
service@oppodigital.com

51982158

V1.0

oppo[®]

www.oppodigital.com