



Roland

GO:PIANO88



**DIGITAL PIANO
Owner's Manual**

Before using this unit, carefully read “USING THE UNIT SAFELY” and “IMPORTANT NOTES” (the leaflet “USING THE UNIT SAFELY”). After reading, keep the document(s) where it will be available for immediate reference.

Copyright © 2017 ROLAND CORPORATION

Intellectual Property Right

- It is forbidden by law to make an audio recording, video recording, copy or revision of a third party's copyrighted work (musical work, video work, broadcast, live performance, or other work), whether in whole or in part, and distribute, sell, lease, perform, or broadcast it without the permission of the copyright owner.
- Do not use this product for purposes that could infringe on a copyright held by a third party. We assume no responsibility whatsoever with regard to any infringements of third-party copyrights arising through your use of this product.
- The copyright of content in this product (the sound waveform data, style data, accompaniment patterns, phrase data, audio loops and image data) is reserved by Roland Corporation.
- Purchasers of this product are permitted to utilize said content (except song data such as Demo Songs) for the creating, performing, recording and distributing original musical works.
- Purchasers of this product are NOT permitted to extract said content in original or modified form, for the purpose of distributing recorded medium of said content or making them available on a computer network.
- Roland is an either registered trademark or trademark of Roland Corporation in the United States and/or other countries.
- Company names and product names appearing in this document are registered trademarks or trademarks of their respective owners.

Table of Contents

Panel Description	
Front Panel.....	4
Rear Panel.....	5
Setup	
Connecting to Power Supply.....	5
Setting the Music Rest.....	5
Connections	
Connecting a Pair of Headphones.....	6
Connecting an Audio Equipment.....	6
Connecting a Pedal.....	6
Connecting a Computer.....	6
Turning the Power On or Off.....	7
Adjusting the Master Volume.....	7
Playing Demo Songs.....	7
Tones	
Selecting a Tone.....	8
Layering Two Tones.....	8
Key Touch.....	8
Reverb.....	9
Metronome.....	9
Tempo.....	10
Transpose.....	10
Master Tuning.....	10
Twin Piano.....	11
Bluetooth.....	11
MIDI Out.....	11
Auto Power Off.....	12
Troubleshooting.....	12
Specifications.....	13
Appendices	
Tone List.....	13
Demo List.....	13
List of Operations (Button + Key).....	14
MIDI Implementation Chart.....	15

Panel Description

Front Panel

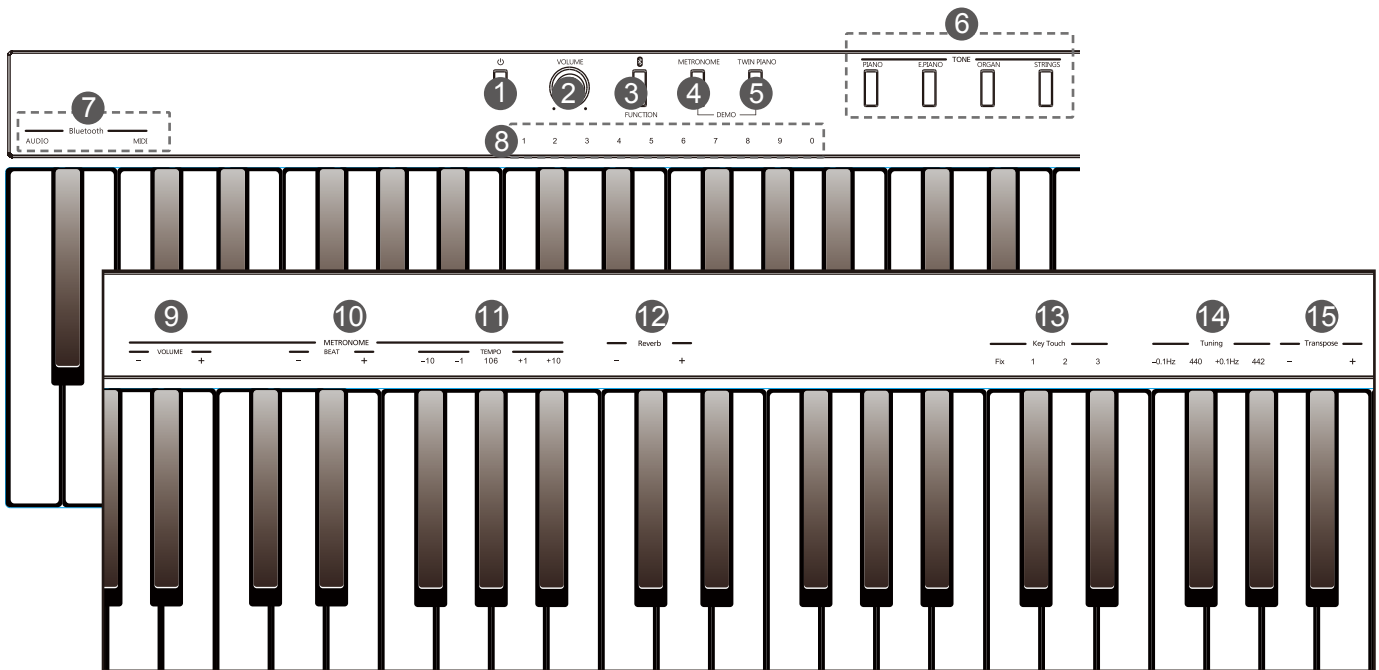

1. [POWER] Switch

Turn the power on or off.

2. [VOLUME] Knob

Adjust the master volume.

3. [FUNCTION] Button

Press and hold it to access secondary functions of other keys.

4. [METRONOME] Button

Press it to turn the metronome on or off.
Press [METRONOME] and [TWIN PIANO] at the same time to enter Demo mode.

5. [TWIN PIANO] Button

Press it to turn the Twin Piano function on or off.
Press [METRONOME] and [TWIN PIANO] at the same time to enter Demo mode.

6. [TONE] Buttons

Press one of these buttons to select a preset tone.

7. [Bluetooth] Keys

Press and hold [FUNCTION], then press one of these keys to disable the related Bluetooth connection.

8. [1~9~0] Keys

Press and hold [METRONOME], then press these keys to enter a tempo value.
Press and hold [METRONOME] and [TWIN PIANO] at the same time, then press one of these keys to select a demo song.

9. [VOLUME] Keys

Press and hold [FUNCTION] or [METRONOME], then press one of these keys to adjust the metronome volume.

10. [BEAT] Keys

Press and hold [FUNCTION] or [METRONOME], then press one of these keys to set the metronome time signature.

11. [TEMPO] Keys

Press and hold [FUNCTION] or [METRONOME], then press one of these keys to edit the tempo value.

12. [Reverb] Keys

Press and hold [FUNCTION], then press one of these keys to adjust the reverb level.

13. [Key Touch] Keys

Press and hold [FUNCTION], then press one of these keys to select an appropriate touch level.

14. [Tuning] Keys

Press and hold [FUNCTION], then press one of these keys to adjust the current tuning.

15. [Transpose] Keys

Press and hold [FUNCTION], then press one of these keys to adjust the transpose value.

Rear Panel

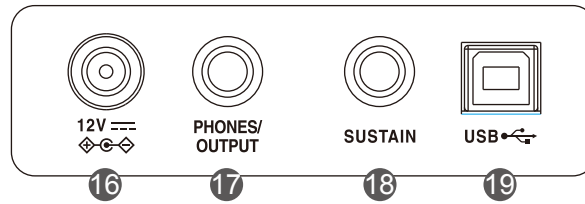

16. DC IN Jack

Connect the specified power adaptor.

17. PHONES/OUTPUT Jack

Connect a pair of stereo headphones or external audio equipment.

18. SUSTAIN Jack

Connect the included pedal.

19. USB Jack

Connect to a computer.

Setup

Connecting to Power Supply

You can power the instrument either by using the included power adaptor or by using batteries.

Using Power Adaptor:

1. Choose the included adaptor plug that fits the type of AC outlet used in your region. Follow the images to slide the adaptor plug into the grooves of the power adaptor unit.
2. Connect one end of the power adaptor to the DC IN jack on the rear panel of the instrument.
3. Plug the power adaptor into an appropriate AC outlet.

Notes:

1. The adaptor plugs for the power adaptor are only for use with this instrument. Do not use them with any other device. Do not attach anything other than the included adaptor plugs to the power adaptor.
2. For your safety, please unplug the instrument when it is not in use or during a thunderstorm.

Using Batteries:

The instrument requires six D-size alkaline batteries or equivalent for power supply.

1. Open the battery compartment cover located on the bottom of the instrument.
2. Insert the batteries. Carefully follow the polarity markings on the cabinet.
3. Replace the compartment cover. Make sure it locks firmly in place.

Notes:

1. Do not mix used and new batteries.
2. Do not mix different types of batteries.
3. Remove the batteries from the instrument when it is not in use for a long period of time.

Setting the Music Rest

A music rest is supplied with the instrument. You can easily attach it to the instrument by inserting it into the slots at the rear of the panel.

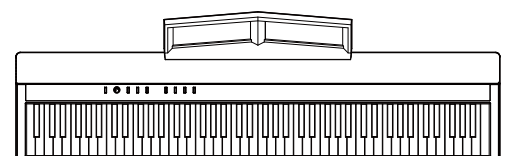
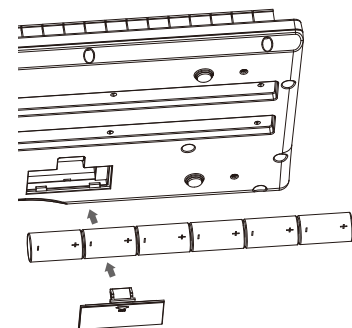
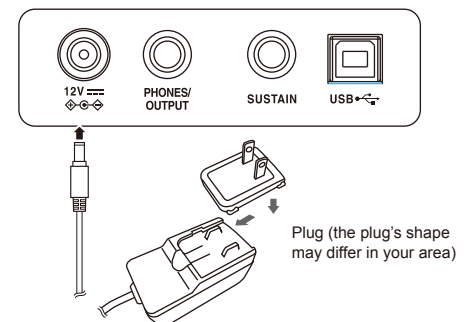

Connections

Connecting a Pair of Headphones

Plug a pair of standard stereo headphones in the PHONES/OUTPUT jack.

Turn on the Phones Sense.

Press and hold [FUNCTION], then press the [F7] key to turn on the Phone Sense function. When headphones are connected, the internal speakers system will be muted. Sound can only be heard from the headphones.

Turn off the Phone Sense.

Press and hold [FUNCTION], then press the [F#7] key to disable the Phone Sense function. When headphones are connected, the sound can be heard from the headphones and speakers.

Note:

To avoid the risk of hearing loss, do not use headphones at high volume levels for a long period of time.

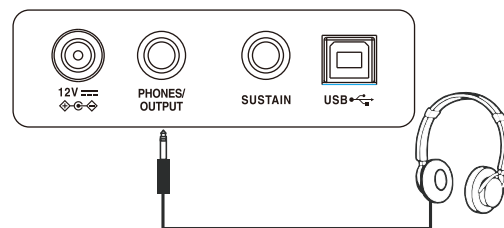

Connecting an Audio Equipment

The PHONES/OUTPUT jack delivers the output of the instrument to external audio equipment such as a keyboard amplifier, stereo sound system, mixing console, or recording interface.

Use an audio cable to connect the PHONES/OUTPUT jack of the instrument to the INPUT jack of the external audio equipment.

Notes:

1. Turn off the power to all devices before connecting or disconnecting external equipment.
2. To avoid damaging the speakers, set the master volume level to minimum before turning on the power.

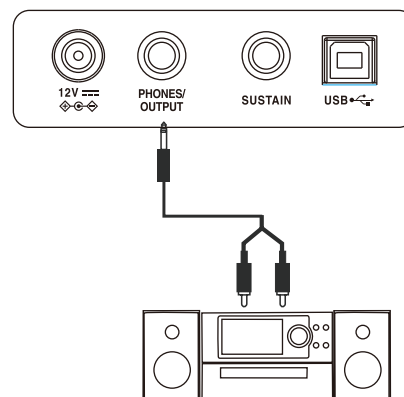

Connecting a Pedal

Plug the included pedal into the SUSTAIN jack. When you step on the pedal, the notes you play on the keyboard will have a longer sustain.

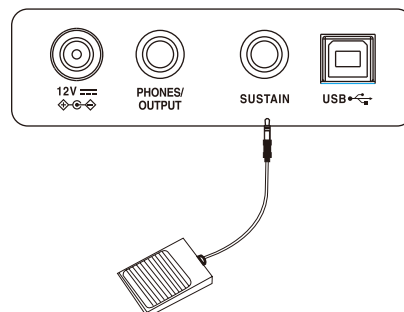

Connecting a Computer

Use a standard USB cable to connect the USB jack of the instrument to the USB port of a computer.

With USB, you can save the MIDI data played on the keyboard to the computer or use the instrument to play back the MIDI data played on the computer.

Note:

Do not set the USB MIDI device to be both input and output simultaneously when configuring the software on your computer. Otherwise, the sound will be overlapped when playing the keyboard.

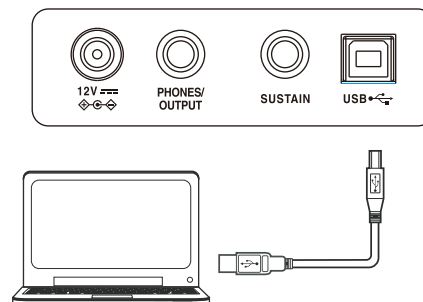

Turning the Power On or Off

1. Make sure the instrument is properly connected to power supply.
2. Rotate the [VOLUME] knob counter-clockwise to set the master volume level to minimum.
3. Press the [POWER] switch. The button LED will light up, indicating the instrument is powered on.
4. When you are ready to turn the instrument off, press and hold the [POWER] switch for a second. The button LED will turn off.

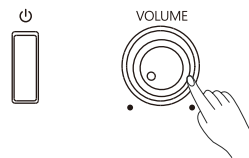

Note:

In order to save energy, the instrument will automatically shut down after 30 minutes when not in use. (See Auto Power Off).

Adjusting the Master Volume

Rotate the [VOLUME] knob clockwise to increase the master volume or counter-clockwise to decrease it. Adjust to set the desired volume level.

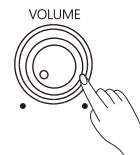

Note:

If the speakers do not produce sound, please check if the master volume is set too low. Then check if the speakers are muted because headphones are plugged into the PHONES jack and the Phones Sense function is in use.

Playing Demo Songs

This instrument features 10 wonderful demo songs. Please refer to Demo List for details.

Play the demo songs.

Press the [METRONOME] and [TWIN PIANO] buttons at the same time to enter Demo mode and start playing the demo songs in a continuous loop.

Select a demo song.

Press and hold the [METRONOME] and [TWIN PIANO] buttons at the same time, then press one of the keys marked [1~9~0] to select a desired demo song.

Stop playing the demo song.

Press the [METRONOME] and [TWIN PIANO] buttons at the same time to stop the demo and exit Demo mode.

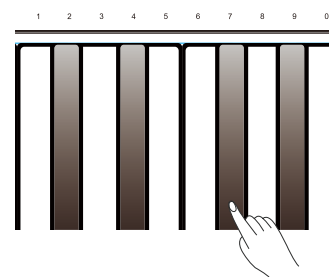
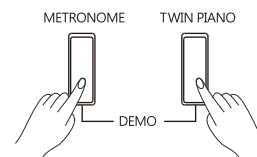

Tones

Selecting a Tone

The instrument features 4 tones. Please refer to Tone List for details.

Press one of the [TONE] buttons to select a desired tone. The button LED of the selected tone will be lit.

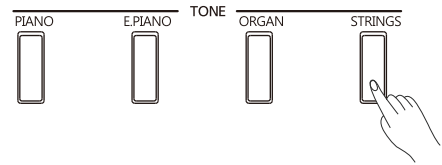

Layering Two Tones

The Dual mode allows two different tones to be layered together, creating a more full and rich sound.

Press two [TONE] buttons to enter Dual mode. The first [TONE] button you press will be set as the upper tone (tone 1), and the second [TONE] button you press will be set as the dual tone (tone 2).

In Dual mode, if you play the keyboard, you will hear two different tones playing together, just like two different instruments being played at the same time.

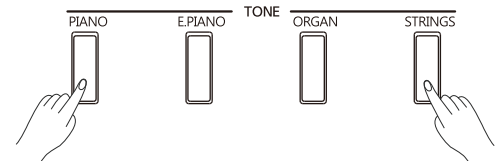

Key Touch

The Key Touch feature allows you to expressively control the voice level based on your playing dynamics.

Press and hold [FUNCTION], then press one of the [Key Touch] keys to select an appropriate touch level.

There are 3 types of touch settings (Fix, 1~3). The default setting is “2”. Selecting “Fix” will result in a fixed volume level, no matter how hard or how softly you play the keys.

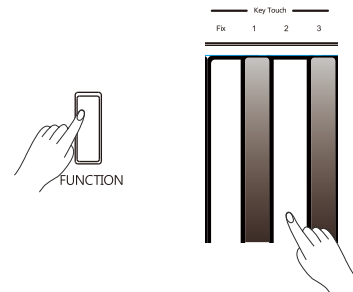

Parameter	Description
Fix	Fixed
1	Light
2	Medium
3	Heavy

Press and hold [FUNCTION], then press one of the [Reverb] keys to set the reverb level range from 0 to 10.

Press and hold [FUNCTION], then press the black key in the [Reverb] keys to restore the default setting. When the reverb level is set to "0", there will be no reverb effect.

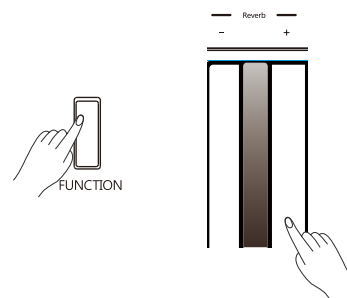

Metronome

The metronome provides a steady beat to help you practice at a preset tempo.

Turn the metronome on or off.

Press the [METRONOME] button to turn the function on or off. When the metronome is in use, the button indicator will flash in sync with the current tempo.



Change the metronome beat.

The instrument provides 6 beat types: 0, 2~6.

Press and hold [FUNCTION] or [METRONOME], then press one of the [BEAT] keys to set the metronome beat.

Press and hold [FUNCTION] or [METRONOME], then press the black key in the [BEAT] keys to restore the default setting.

Press and hold [METRONOME], then press a key [A0] ~ [D1] to select a beat type. Please refer to List of Operations (Button + Key) for details.

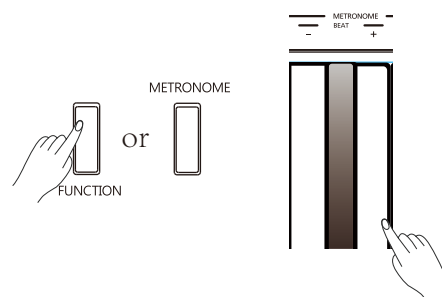

Adjust the metronome volume.

Press and hold [FUNCTION] or [METRONOME], then press one of the [VOLUME] keys to set the volume range from 1 to 10.

Press and hold [FUNCTION] or [METRONOME], then press the black key in the [VOLUME] keys to restore the default setting.

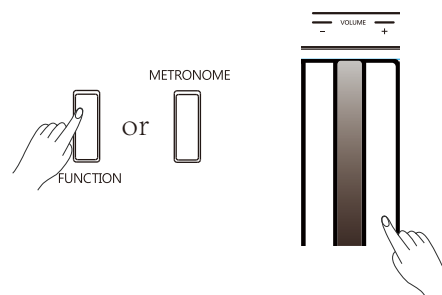

Tempo

You can set the tempo in the following ways:

Press and hold [FUNCTION] or [METRONOME], then press one of the [TEMPO] keys to set the desired tempo.

Press and hold [METRONOME], then press the keys marked [1~9~0] to set the tempo value. For example, press [0], [6], [4] in sequence to enter a tempo value of 64.

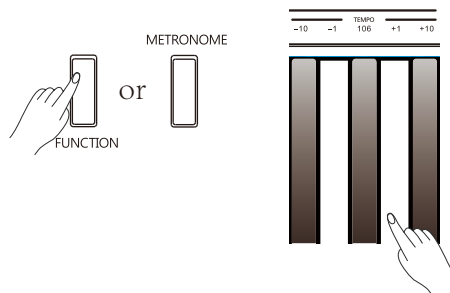

Transpose

The transpose function allows the overall pitch of the instrument to be transposed up or down in semitone steps, over a range of -6 ~ +5.

Press and hold [FUNCTION], then press one of the [Transpose] keys to set the transpose value.

For example, set the transpose value to -5, you will hear “G” pitch when playing the “C” keys.

Press and hold [FUNCTION], then press the black key in the [Transpose] keys to restore the default setting.

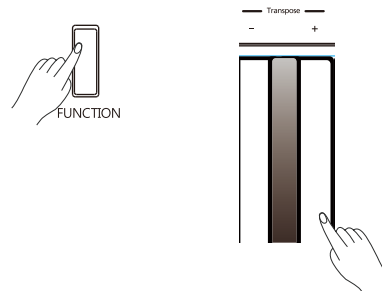

Parameter	Description
+1	To raise the overall pitch by 1 semitone.
-1	To lower the overall pitch by 1 semitone.

Master Tuning

This function adjusts the pitch of the instrument in 0.1Hz increment over a range of 415.3Hz ~ 466.2Hz.

Press and hold [FUNCTION], then press one of the [Tuning] keys to adjust the pitch of the keyboard.

For example, if you press and hold [FUNCTION], then press the key marked [440], it will set the tuning to 440Hz.

Parameter	Description
+0.1Hz	To raise the pitch by 0.1Hz.
-0.1Hz	To lower the pitch by 0.1Hz.

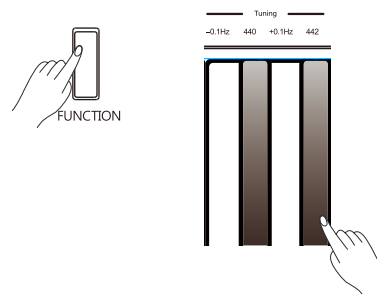

Twin Piano

The Twin Piano function splits the keyboard into two areas with the same pitch and tone, for the convenience of playing together with a friend or instructor.

1. Press the [TWIN PIANO] button to turn on the function. The button LED will be lit. The split point is C4.
2. The upper tone selected before entering Twin Piano will become the default tone for both areas. You can press one of the [TONE] buttons to select a desired tone.
3. Press the [TWIN PIANO] button again to turn off the function. The button LED will turn off.

Notes:

1. Twin Piano function is not available in Demo mode.
2. Dual mode is not available when Twin Piano is in use.

TWIN PIANO

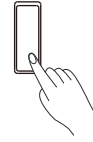

Bluetooth

Bluetooth Pairing

The Bluetooth function is turned on by default. You can pair the instrument with an external Bluetooth device.

The instrument's Bluetooth Audio name: GO:PIANO88 AUDIO.

The instrument's Bluetooth MIDI name: GO:PIANO88.

Disable Bluetooth Connection

Press and hold [FUNCTION], then press the key marked [AUDIO] to disconnect Bluetooth Audio.

Press and hold [FUNCTION], then press the key marked [MIDI] to disconnect Bluetooth MIDI.

When Bluetooth connection is disabled, you can enable Bluetooth connection again by pairing.

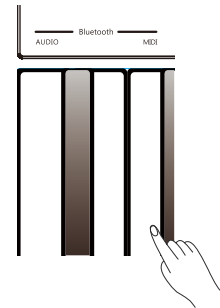

MIDI Out

Press and hold [FUNCTION], then press a key [C2] ~ [D#3] to assign the MIDI Out channel. Please refer to **List of Operations (Button + Key)** for details.

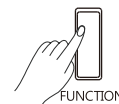

Auto Power Off

The instrument will automatically shut down after 30 minutes of inactivity. You can disable this function or change the time setting.

1. To disable this function: press and hold [FUNCTION], then press the key [C8] (the first key to right side of the keyboard).
2. To set the time to 240 minutes: press and hold [FUNCTION], then press the key [B7].
3. To set the time to 30 minutes: press and hold [FUNCTION], then press the key [A#7].
4. To set the time to 10 minutes: press and hold [FUNCTION], then press the key [A7].

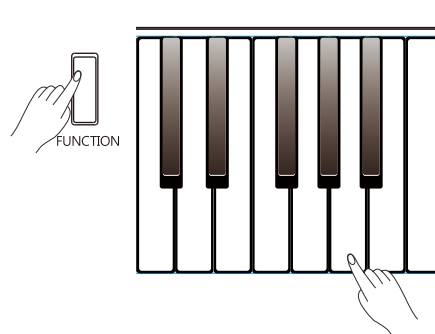

Troubleshooting

Problem	Possible Cause and Solution
The speakers produce a pop sound whenever the power is turned ON/OFF.	This is normal and no cause for alarm.
Speakers do not produce sound when the keyboard is played.	1. Check if the master volume is set too low. 2. Check if headphones are plugged into the PHONES jack.
There is noise when I use a mobile phone.	Using a mobile phone in close proximity to the instrument may produce interference. To prevent this, turn off the mobile phone or use it farther away from the instrument.
When connecting to computer, the instrument cannot be recognized.	Check if the USB cable is firmly connected. Try connecting another USB port on the computer. This instrument is plug and play and should work without installing a driver.
The pedal does not respond.	Check if the pedal cable is firmly connected.
It shuts down after a period of time.	The auto power off function will turn off the instrument after a preset period of time when the instrument is not in use. You can configure the Auto Power Off function, please refer to Auto Power Off in this manual.

Specifications

Keyboard	
Keyboard	88 Keys with Touch Response
Touch Response	3 types, Off
Tones	
Polyphony (max.)	128
Tones	4 panel
Layer	Yes
Twin Piano	Yes
Effects	
Reverb	1 type, 0 - 10 levels
Song	
Demo	10 presets
Pitch Adjustment	
Transpose	-6 - +5
Tuning	415.3Hz - 466.2Hz
Other Functions	
Metronome	Metronome beat: 0, 2 - 6; Metronome volume: 1 - 10
Tempo	30 - 280
Other control	MIDI Out channel, Bluetooth audio, Bluetooth MIDI

Connections	
Interaction & Expansion	USB MIDI, Bluetooth
Phones/Output	Standard stereo
Pedal	Sustain
USB	USB MIDI
Power Supply	
Power	DC12V / 2A
Battery	Six "D-size" alkaline batteries or equivalent
Power Off Protection	Yes
Amplifiers & Speakers	
Amplifiers	10W x 2
Speakers	[15cm x 6cm] x 2
Dimensions & Weight	
Dimensions LWH (mm)	1283 x 292 x 87
Weight (kg)	7.0

* Specifications and descriptions herein are for information only and are subject to change without prior notice.

Appendices

Tone List

No.	Tone Name
1	Acoustic Grand Piano
2	Electric Piano
3	Church Organ
4	String Ensembles

Demo List

No.	Song Name
1	Valse OP.34 NO.1
2	Sonate Nr.16 C Dur
3	Liebesträume Nr.3
4	Fantaisie-Impromptu
5	1ère Gymnopédie
6	Radetzky Marsch
7	Träumerei
8	Frühlingslied
9	Für Elise
10	Menuett G Dur BWV Anh.114

Appendices

List of Operations (Button + Key)

[FUNCTION] + Key

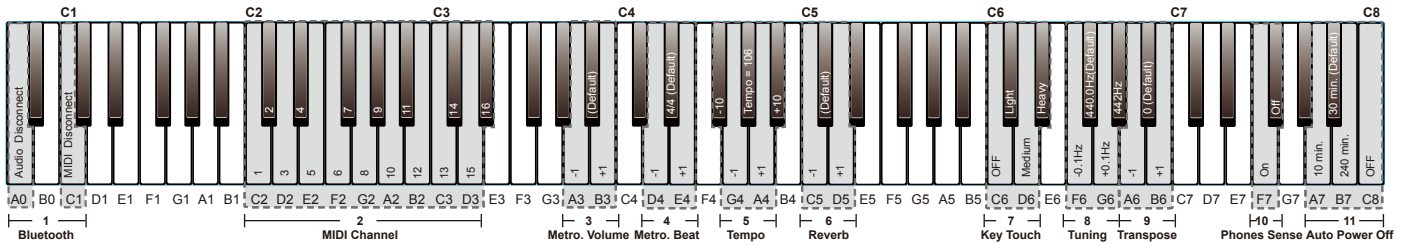

1. [Audio Disconnect] Key
Press to disable Bluetooth Audio connection.

[MIDI Disconnect] Key
Press to disable Bluetooth MIDI connection.

2. [MIDI Channel 1 ~16] Keys
Press to select the MIDI output channel.

3. [Metro. Volume] Keys
Press to adjust the metronome volume.

4. [Metro. Beat] Keys
Press to set the metronome time signature.

5. [Tempo] Keys
Press to edit the tempo value.

6. [Reverb] Keys
Press to set the reverb level.

7. [Key Touch] Keys
Press to select a touch level.

8. [Tuning] Keys
Press to adjust the current tuning.

9. [Transpose] Keys
Press to adjust the transpose value.

10. [Phones Sense] Keys
Press to turn the Phones Sense function on or off.

11. [Auto Power Off] Keys
Press to change the Auto Power Off setting.

[METRONOME] + Key

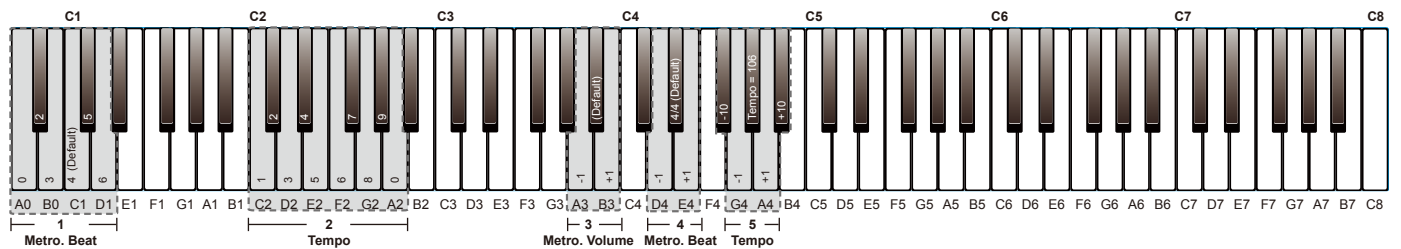

1. [Metro. Beat] Keys
Press to select a beat type.

2. [Tempo] Keys
Press to enter a tempo value.

3. [Metro. Volume] Keys
Press to adjust the metronome volume.

4. [Metro. Beat] Keys
Press to set the metronome time signature.

5. [Tempo] Keys
Press to edit the tempo value.

[METRONOME] + [TWIN PIANO] + Key

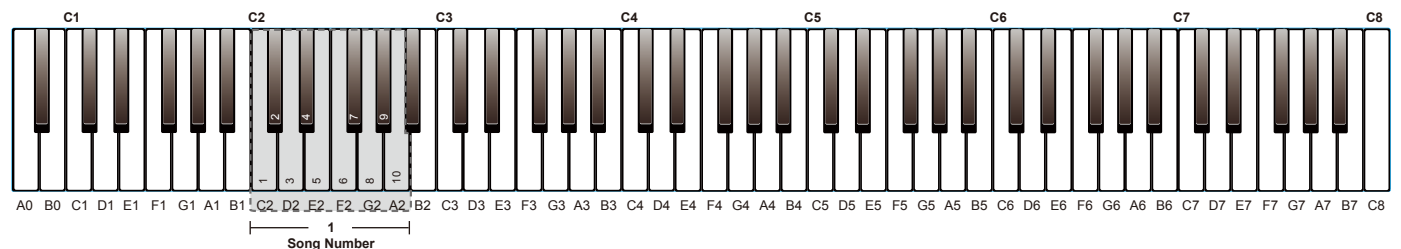

1. [Song Number] Keys
Press to select a demo song.

MIDI Implementation Chart

Function		Transmitted	Recognized	Remarks
Basic	Default	1	ALL	
Channel	Changed	1-16	1-16	
Mode	Default	x	3	
	Messages	x	3	
	Altered	*****	x	
Note Number	Note	0-127	0-127	
	:True voice	*****	0-127	
Velocity	Note on	o 9nH,V=1-127	o 9nH,V=1-127	
	Note off	x (9nH,V=0)	o(9nH,V=0; 8nH,V= 0-127)	
After Touch	key's	x	x	
	Ch's	x	x	
Pitch Bend		x	o	
Control Change	0	o	o	Bank Select
	1	x	o	Modulation
	5	x	o	Portamento Time
	6	o	o	Data Entry
	7	o	o	Volume
	10	x	o	Pan
	11	x	o	Expression
	64	o	o	Sustain Pedal
	65	x	o	Portamento ON/OFF
	66	o	o	Sostenuto Pedal
	67	o	o	Soft Pedal
	80	x	x	Reverb Program
	81	x	x	Chorus Program
	91	o	o	Reverb Level
	93	o	o	Chorus Level
	120	x	o	All Sound Off
121	x	x	Reset All Controllers	
123	o	o	All Notes Off	
Program Change	: True	*****	1-127	
System Exclusive		x	o	
System Common	:Song Position	x	x	
	:Song Select	x	x	
	:Tune	x	x	
System Real Time	:Clock	o	x	
	:Commands	x	x	
Aux Messages	:LOCAL ON/OFF	x	x	
	:Active sense	o	o	
	:Reset	x	o	
Notes:				

- Mode 1: OMNI ON, POLY
- Mode 2: OMNI ON ,MONO

- Mode 3: OMNI OFF, POLY
- Mode 4: OMNI OFF, MONO

- o: YES
- x: NO

