

PDX3000

3000 Watt Two Channel Amplifier with DSP Control

EN

EN Important Safety Instructions

Terminals marked with this symbol carry electrical current of sufficient magnitude to constitute risk of electric shock.

Use only high-quality professional speaker cables with ¼" TS or twist-locking plugs pre-installed. All other installation or modification should be performed only by qualified personnel.



This symbol, wherever it appears, alerts you to the presence of uninsulated dangerous voltage inside the enclosure - voltage that may be sufficient to constitute a risk of shock.



This symbol, wherever it appears, alerts you to important operating and maintenance instructions in the accompanying literature. Please read the manual.



Caution
To reduce the risk of electric shock, do not remove the top cover (or the rear section). No user serviceable parts inside. Refer servicing to qualified personnel.



Caution
To reduce the risk of fire or electric shock, do not expose this appliance to rain and moisture. The apparatus shall not be exposed to dripping or splashing liquids and no objects filled with liquids, such as vases, shall be placed on the apparatus.



Caution
These service instructions are for use by qualified service personnel only. To reduce the risk of electric shock do not perform any servicing other than that contained in the operation instructions. Repairs have to be performed by qualified service personnel.

1. Read these instructions.
2. Keep these instructions.
3. Heed all warnings.
4. Follow all instructions.
5. Do not use this apparatus near water.
6. Clean only with dry cloth.
7. Do not block any ventilation openings. Install in accordance with the manufacturer's instructions.
8. Do not install near any heat sources such as radiators, heat registers, stoves, or other apparatus (including amplifiers) that produce heat.

9. Do not defeat the safety purpose of the polarized or grounding-type plug. A polarized plug has two blades with one wider than the other. A grounding-type plug has two blades and a third grounding prong. The wide blade or the third prong are provided for your safety. If the provided plug does not fit into your outlet, consult an electrician for replacement of the obsolete outlet.

10. Protect the power cord from being walked on or pinched particularly at plugs, convenience receptacles, and the point where they exit from the apparatus.

11. Use only attachments/accessories specified by the manufacturer.



12. Use only with the cart, stand, tripod, bracket, or table specified by the manufacturer, or sold with the apparatus. When a cart is used, use caution when moving the cart/apparatus combination to avoid

injury from tip-over.

13. Unplug this apparatus during lightning storms or when unused for long periods of time.

14. Refer all servicing to qualified service personnel. Servicing is required when the apparatus has been damaged in any way, such as power supply cord or plug is damaged, liquid has been spilled or objects have fallen into the apparatus, the apparatus has been exposed to rain or moisture, does not operate normally, or has been dropped.

15. The apparatus shall be connected to a MAINS socket outlet with a protective earthing connection.

16. Where the MAINS plug or an appliance coupler is used as the disconnect device, the disconnect device shall remain readily operable.

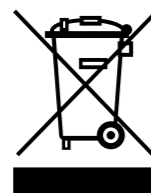

17. Correct disposal of this product: This symbol indicates that this product must not be disposed of with household waste, according to the WEEE Directive (2012/19/EU) and your national law. This product should be taken

to a collection center licensed for the recycling of waste electrical and electronic equipment (EEE). The mishandling of this type of waste could have a possible negative impact on the environment and human health due to potentially hazardous substances that are generally associated with EEE. At the same time, your cooperation in the correct disposal of this product will contribute to the efficient use of natural resources. For more information about where you can take your waste equipment for recycling, please contact your local city office, or your household waste collection service.

18. Do not install in a confined space, such as a book case or similar unit.

19. Do not place naked flame sources, such as lighted candles, on the apparatus.

20. Please keep the environmental aspects of battery disposal in mind. Batteries must be disposed of at a battery collection point.

21. Use this apparatus in tropical and/or moderate climates.

LEGAL DISCLAIMER

Music Tribe accepts no liability for any loss which may be suffered by any person who relies either wholly or in part upon any description, photograph, or statement contained herein. Technical specifications, appearances and other information are subject to change without notice. All trademarks are the property of their respective owners. Midas, Klark Teknik, Lab Gruppen, Lake, Tannoy, Turbosound, TC Electronic, TC Helicon, Behringer, Bugera, Auratone and Coolaudio are trademarks or registered trademarks of Music Tribe Global Brands Ltd. © Music Tribe Global Brands Ltd. 2019 All rights reserved.

LIMITED WARRANTY

For the applicable warranty terms and conditions and additional information regarding Music Tribe's Limited Warranty, please see complete details online at musictribe.com/warranty.

Zhongshan Eurotec Electronics Limited
No. 10 Wanmei Road, South China Modern Chinese Medicine Park, Nanlang Town, 528451, Zhongshan City, Guangdong Province, China

ES Instrucciones de seguridad

Las terminales marcadas con este símbolo transportan corriente eléctrica de magnitud suficiente como para constituir un riesgo de descarga eléctrica. Utilice solo cables de altavoz profesionales y de alta calidad con conectores TS de 6,3 mm o de bayoneta prefijados. Cualquier otra instalación o modificación debe ser realizada únicamente por un técnico cualificado.



Este símbolo, siempre que aparece, le advierte de la presencia de voltaje peligroso sin aislar dentro de la caja; este voltaje puede ser suficiente para constituir un riesgo de descarga.



Este símbolo, siempre que aparece, le advierte sobre instrucciones operativas y de mantenimiento que aparecen en la documentación adjunta. Por favor, lea el manual.



Atención
Para reducir el riesgo de descarga eléctrica, no quite la tapa (o la parte posterior). No hay piezas en el interior del equipo que puedan ser reparadas por el usuario. Si es necesario, póngase en contacto con personal cualificado.



Atención
Para reducir el riesgo de incendio o descarga eléctrica, no exponga este aparato a la lluvia, humedad o alguna otra fuente que pueda salpicar o derramar algún líquido sobre el aparato. No coloque ningún tipo de recipiente para líquidos sobre el aparato.



Atención
Las instrucciones de servicio deben llevarlas a cabo exclusivamente personal cualificado. Para evitar el riesgo de una descarga eléctrica, no realice reparaciones que no se encuentren descritas en el manual de operaciones. Las reparaciones deben ser realizadas exclusivamente por personal cualificado.

1. Lea las instrucciones.
2. Conserve estas instrucciones.
3. Preste atención a todas las advertencias.
4. Siga todas las instrucciones.
5. No use este aparato cerca del agua.
6. Limpie este aparato con un paño seco.
7. No bloquee las aberturas de ventilación. Instale el equipo de acuerdo con las instrucciones del fabricante.
8. No instale este equipo cerca de fuentes de calor tales como radiadores, acumuladores de calor, estufas u otros aparatos (incluyendo amplificadores) que puedan producir calor.

9. No elimine o deshabilite nunca la conexión a tierra del aparato o del cable de alimentación de corriente. Un enchufe polarizado tiene dos polos, uno de los cuales tiene un contacto más ancho que el otro. Una clavija con puesta a tierra dispone de tres contactos: dos polos y la puesta a tierra. El contacto ancho y el tercer contacto, respectivamente, son los que garantizan una mayor seguridad. Si el enchufe suministrado con el equipo no concuerda con la toma de corriente, consulte con un electricista para cambiar la toma de corriente obsoleta.

10. Coloque el cable de suministro de energía de manera que no pueda ser pisado y que esté protegido de objetos afilados. Asegúrese de que el cable de suministro de energía esté protegido, especialmente en la zona de la clavija y en el punto donde sale del aparato.

11. Use únicamente los dispositivos o accesorios especificados por el fabricante.



12. Use únicamente la carretilla, plataforma, trípode, soporte o mesa especificados por el fabricante o suministrados junto con el equipo. Al transportar el equipo, tenga cuidado para evitar daños y caídas al tropezar con algún obstáculo.

13. Desenchufe el equipo durante tormentas o si no va a utilizarlo durante un periodo largo.

14. Confíe las reparaciones únicamente a servicios técnicos cualificados. La unidad requiere mantenimiento siempre que haya sufrido algún daño, si el cable de suministro de energía o el enchufe presentaran daños, se hubiera derramado un líquido o hubieran caído objetos dentro del equipo, si el aparato hubiera estado expuesto a la humedad o la lluvia, si ha dejado de funcionar de manera normal o si ha sufrido algún golpe o caída.

15. Al conectar la unidad a la toma de corriente eléctrica asegúrese de que la conexión disponga de una unión a tierra.

16. Si el enchufe o conector de red sirve como único medio de desconexión, éste debe ser accesible fácilmente.



17. Cómo debe deshacerse de este aparato: Este símbolo indica que este aparato no debe ser tratado como basura orgánica, según lo indicado en la Directiva WEEE (2012/19/EU) y a las normativas aplicables en su país.

En lugar de ello deberá llevarlo al punto limpio más cercano para el reciclaje de sus elementos eléctricos / electrónicos (EEE). Al hacer esto estará ayudando a prevenir las posibles consecuencias negativas para el medio ambiente y la salud que podrían ser provocadas por una gestión inadecuada de este tipo de aparatos. Además, el reciclaje de materiales ayudará a conservar los recursos naturales. Para más información acerca del reciclaje de este aparato, póngase en contacto con el Ayuntamiento de su ciudad o con el punto limpio local.

18. No instale esta unidad en un espacio muy reducido, tal como encastrada en una librería o similar.

19. No coloque objetos con llama, como una vela encendida, sobre este aparato.

20. Tenga presentes todas las advertencias relativas al reciclaje y correcta eliminación de las pilas. Las pilas deben ser siempre eliminadas en un punto limpio y nunca con el resto de la basura orgánica.

21. Use este aparato en rangos de temperatura moderados y/o tropicales.

NEGACIÓN LEGAL

Music Tribe no admite ningún tipo de responsabilidad por cualquier daño o pérdida que pudiera sufrir cualquier persona por confiar total o parcialmente en la descripciones, fotografías o afirmaciones contenidas en este documento. Las especificaciones técnicas, imágenes y otras informaciones contenidas en este documento están sujetas a modificaciones sin previo aviso. Todas las marcas comerciales que aparecen aquí son propiedad de sus respectivos dueños. Midas, Klark Teknik, Lab Gruppen, Lake, Tannoy, Turbosound, TC Electronic, Behringer, Bugera, Auratone y Coolaudio son marcas comerciales o marcas registradas de Music Tribe Global Brands Ltd. © Music Tribe Global Brands Ltd. 2019 Reservados todos los derechos.

GARANTÍA LIMITADA

Si quiere conocer los detalles y condiciones aplicables de la garantía así como información adicional sobre la Garantía limitada de Music Tribe, consulte online toda la información en la web musictribe.com/warranty.

EN

ES

FR Consignes de sécurité



Les points repérés par ce symbole portent une tension électrique suffisante pour constituer un risque d'électrocution.

Utilisez uniquement des câbles d'enceintes professionnels de haute qualité avec fiches Jack mono 6,35 mm ou fiches à verrouillages déjà installées. Toute autre installation ou modification doit être effectuée uniquement par un personnel qualifié.



Ce symbole avertit de la présence d'une tension dangereuse et non isolée à l'intérieur de l'appareil - elle peut provoquer des chocs électriques.



Attention

Ce symbole signale les consignes d'utilisation et d'entretien ! Tien importantes dans la documentation fournie. Lisez les consignes de sécurité du manuel d'utilisation de l'appareil.



Attention

Pour éviter tout risque de choc électrique, ne pas ouvrir le capot de l'appareil ni démonter le panneau arrière. L'intérieur de l'appareil ne possède aucun élément réparable par l'utilisateur. Laissez toute réparation à un professionnel qualifié.



Attention

Pour réduire les risques de feu et de choc électrique, n'exposez pas cet appareil à la pluie, à la moisissure, aux gouttes ou aux éclaboussures. Ne posez pas de récipient contenant un liquide sur l'appareil (un vase par exemple).



Attention

Ces consignes de sécurité et d'entretien sont destinées à un personnel qualifié. Pour éviter tout risque de choc électrique, n'effectuez aucune réparation sur l'appareil qui ne soit décrite par le manuel d'utilisation. Les éventuelles réparations doivent être effectuées uniquement par un technicien spécialisé.

1. Lisez ces consignes.
2. Conservez ces consignes.
3. Respectez tous les avertissements.
4. Respectez toutes les consignes d'utilisation.
5. N'utilisez jamais l'appareil à proximité d'un liquide.
6. Nettoyez l'appareil avec un chiffon sec.
7. Veillez à ne pas empêcher la bonne ventilation de l'appareil via ses ouïes de ventilation. Respectez les consignes du fabricant concernant l'installation de l'appareil.
8. Ne placez pas l'appareil à proximité d'une source de chaleur telle qu'un chauffage, une cuisinière ou tout appareil dégageant de la chaleur (y compris un ampli de puissance).

9. Ne supprimez jamais la sécurité des prises bipolaires ou des prises terre. Les prises bipolaires possèdent deux contacts de largeur différente. Le plus large est le contact de sécurité. Les prises terre possèdent deux contacts plus une mise à la terre servant de sécurité. Si la prise du bloc d'alimentation ou du cordon d'alimentation fourni ne correspond pas à celles de votre installation électrique, faites appel à un électricien pour effectuer le changement de prise.

10. Installez le cordon d'alimentation de telle façon que personne ne puisse marcher dessus et qu'il soit protégé d'arêtes coupantes. Assurez-vous que le cordon d'alimentation est suffisamment protégé, notamment au niveau de sa prise électrique et de l'endroit où il est relié à l'appareil; cela est également valable pour une éventuelle rallonge électrique.

11. Utilisez exclusivement des accessoires et des appareils supplémentaires recommandés par le fabricant.



12. Utilisez exclusivement des chariots, des diables, des présentoirs, des pieds et des surfaces de travail recommandés par le fabricant ou livrés avec le produit.

Déplacez précautionneusement tout chariot ou diable chargé pour éviter d'éventuelles blessures en cas de chute.

13. Débranchez l'appareil de la tension secteur en cas d'orage ou si l'appareil reste inutilisé pendant une longue période de temps.

14. Les travaux d'entretien de l'appareil doivent être effectués uniquement par du personnel qualifié. Aucun entretien n'est nécessaire sauf si l'appareil est endommagé de quelque façon que ce soit (dommages sur le cordon d'alimentation ou la prise par exemple), si un liquide ou un objet a pénétré à l'intérieur du châssis, si l'appareil a été exposé à la pluie ou à l'humidité, s'il ne fonctionne pas correctement ou à la suite d'une chute.

15. L'appareil doit être connecté à une prise secteur dotée d'une protection par mise à la terre.

16. La prise électrique ou la prise IEC de tout appareil dénué de bouton marche/arrêt doit rester accessible en permanence.

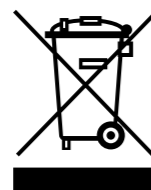

17. Mise au rebut appropriée de ce produit: Ce symbole indique qu'en accord avec la directive DEEE (2012/19/EU) et les lois en vigueur dans votre pays, ce produit ne doit pas être jeté avec les déchets ménagers. Ce produit doit être

déposé dans un point de collecte agréé pour le recyclage des déchets d'équipements électriques et électroniques (EEE). Une mauvaise manipulation de ce type de déchets pourrait avoir un impact négatif sur l'environnement et la santé à cause des substances potentiellement dangereuses généralement associées à ces équipements. En même temps, votre coopération dans la mise au rebut de ce produit contribuera à l'utilisation efficace des ressources naturelles. Pour plus d'informations sur l'endroit où vous pouvez déposer vos déchets

d'équipements pour le recyclage, veuillez contacter votre mairie ou votre centre local de collecte des déchets.

18. N'installez pas l'appareil dans un espace confiné tel qu'une bibliothèque ou meuble similaire.

19. Ne placez jamais d'objets enflammés, tels que des bougies allumées, sur l'appareil.

20. Gardez à l'esprit l'impact environnemental lorsque vous mettez des piles au rebus. Les piles usées doivent être déposées dans un point de collecte adapté.

21. Utilisez l'appareil dans un climat tropical et/ou modéré.

DÉNI LÉGAL

Music Tribe ne peut être tenu pour responsable pour toute perte pouvant être subie par toute personne se fiant en partie ou en totalité à toute description, photographie ou affirmation contenue dans ce document. Les caractéristiques, l'apparence et d'autres informations peuvent faire l'objet de modifications sans notification. Toutes les marques appartiennent à leurs propriétaires respectifs. Midas, Klark Teknik, Lab Gruppen, Lake, Tannoy, Turbosound, TC Electronic, TC Helicon, Behringer, Bugera, Auratone et Coolaudio sont des marques ou marques déposées de Music Tribe Global Brands Ltd. © Music Tribe Global Brands Ltd. 2019 Tous droits réservés.

GARANTIE LIMITÉE

Pour connaître les termes et conditions de garantie applicables, ainsi que les informations supplémentaires et détaillées sur la Garantie Limitée de Music Tribe, consultez le site Internet musictribe.com/warranty.

DE Wichtige Sicherheitshinweise



Vorsicht

Die mit dem Symbol markierten Anschlüsse führen so viel Spannung, dass die Gefahr eines Stromschlags besteht.

Verwenden Sie nur hochwertige, professionelle Lautsprecherkabel mit vorinstallierten 6,35 mm MONO-Klinkensteckern oder Lautsprecherstecker mit Drehverriegelung. Alle anderen Installationen oder Modifikationen sollten nur von qualifiziertem Fachpersonal ausgeführt werden.



Achtung

Um eine Gefährdung durch Stromschlag auszuschließen, darf die Geräteabdeckung bzw. Geräterückwand nicht abgenommen werden. Im Innern des Geräts befinden sich keine vom Benutzer reparierbaren Teile. Reparaturarbeiten dürfen nur von qualifiziertem Personal ausgeführt werden.



Achtung

Um eine Gefährdung durch Feuer bzw. Stromschlag auszuschließen, darf dieses Gerät weder Regen oder Feuchtigkeit ausgesetzt werden noch sollten Spritzwasser oder tropfende Flüssigkeiten in das Gerät gelangen können. Stellen Sie keine mit Flüssigkeit gefüllten Gegenstände, wie z. B. Vasen, auf das Gerät.



Achtung

Die Service-Hinweise sind nur durch qualifiziertes Personal zu befolgen. Um eine Gefährdung durch Stromschlag zu vermeiden, führen Sie bitte keinerlei Reparaturen an dem Gerät durch, die nicht in der Bedienungsanleitung beschrieben sind. Reparaturen sind nur von qualifiziertem Fachpersonal durchzuführen.

1. Lesen Sie diese Hinweise.
2. Bewahren Sie diese Hinweise auf.
3. Beachten Sie alle Warnhinweise.
4. Befolgen Sie alle Bedienungshinweise.
5. Betreiben Sie das Gerät nicht in der Nähe von Wasser.
6. Reinigen Sie das Gerät mit einem trockenen Tuch.
7. Blockieren Sie nicht die Belüftungsschlitze. Beachten Sie beim Einbau des Gerätes die Herstellerhinweise.
8. Stellen Sie das Gerät nicht in der Nähe von Wärmequellen auf. Solche Wärmequellen sind z. B. Heizkörper, Herde oder andere Wärme erzeugende Geräte (auch Verstärker).
9. Entfernen Sie in keinem Fall die Sicherheitsvorrichtung von Zweipol- oder geerdeten Steckern. Ein Zweipolstecker hat zwei unterschiedlich breite Steckkontakte. Ein geerdeter Stecker hat zwei Steckkontakte und einen dritten Erdungskontakt. Der breitere Steckkontakt oder der zusätzliche

Erdungskontakt dient Ihrer Sicherheit. Falls das mitgelieferte Steckerformat nicht zu Ihrer Steckdose passt, wenden Sie sich bitte an einen Elektriker, damit die Steckdose entsprechend ausgetauscht wird.

10. Verlegen Sie das Netzkabel so, dass es vor Tritten und scharfen Kanten geschützt ist und nicht beschädigt werden kann. Achten Sie bitte insbesondere im Bereich der Stecker, Verlängerungskabel und an der Stelle, an der das Netzkabel das Gerät verlässt, auf ausreichenden Schutz.

11. Das Gerät muss jederzeit mit intaktem Schutzleiter an das Stromnetz angeschlossen sein.

12. Sollte der Hauptnetzstecker oder eine Gerätesteckdose die Funktionseinheit zum Abschalten sein, muss diese immer zugänglich sein.

13. Verwenden Sie nur Zusatzgeräte/Zubehörteile, die laut Hersteller geeignet sind.



14. Verwenden Sie nur Wagen, Standvorrichtungen, Stative, Halter oder Tische, die vom Hersteller benannt oder im Lieferumfang des Geräts enthalten sind. Falls Sie einen

Wagen benutzen, seien Sie vorsichtig beim Bewegen der Wagen-Gerätkombination, um Verletzungen durch Stolpern zu vermeiden.

15. Ziehen Sie den Netzstecker bei Gewitter oder wenn Sie das Gerät längere Zeit nicht benutzen.

16. Lassen Sie alle Wartungsarbeiten nur von qualifiziertem Service-Personal ausführen. Eine Wartung ist notwendig, wenn das Gerät in irgendeiner Weise beschädigt wurde (z. B. Beschädigung des Netzkabels oder Steckers), Gegenstände oder Flüssigkeit in das Geräteinnere gelangt sind, das Gerät Regen oder Feuchtigkeit ausgesetzt wurde, das Gerät nicht ordnungsgemäß funktioniert oder auf den Boden gefallen ist.



17. Korrekte Entsorgung dieses Produkts: Dieses Symbol weist darauf hin, das Produkt entsprechend der WEEE Richtlinie (2012/19/EU) und der jeweiligen nationalen Gesetze nicht zusammen mit Ihren

Haushaltsabfällen zu entsorgen. Dieses Produkt sollte bei einer autorisierten Sammelstelle für Recycling elektrischer und elektronischer Geräte (EEE) abgegeben werden. Wegen bedenklicher Substanzen, die generell mit elektrischen und elektronischen Geräten in Verbindung stehen, könnte eine unsachgemäße Behandlung dieser Abfallart eine negative Auswirkung auf Umwelt und Gesundheit haben. Gleichzeitig gewährleistet Ihr Beitrag zur richtigen Entsorgung dieses Produkts die effektive Nutzung natürlicher Ressourcen. Für weitere Informationen zur Entsorgung Ihrer Geräte bei einer Recycling-Stelle nehmen Sie bitte Kontakt zum zuständigen städtischen Büro, Entsorgungsamt oder zu Ihrem Haushaltsabfallentsorger auf.

18. Installieren Sie das Gerät nicht in einer beengten Umgebung, zum Beispiel Bücherregal oder ähnliches.

19. Stellen Sie keine Gegenstände mit offenen Flammen, etwa brennende Kerzen, auf das Gerät.

20. Beachten Sie bei der Entsorgung von Batterien den Umweltschutz-Aspekt. Batterien müssen bei einer Batterie-Sammelstelle entsorgt werden.

21. Verwenden Sie das Gerät in tropischen und/oder gemäßigten Klimazonen.

HAFTUNGS-AUSSCHLUSS

Music Tribe übernimmt keine Haftung für Verluste, die Personen entstanden sind, die sich ganz oder teilweise auf hier enthaltene Beschreibungen, Fotos oder Aussagen verlassen haben. Technische Daten, Erscheinungsbild und andere Informationen können ohne vorherige Ankündigung geändert werden. Alle Warenzeichen sind Eigentum der jeweiligen Inhaber. Midas, Klark Teknik, Lab Gruppen, Lake, Tannoy, Turbosound, TC Electronic, TC Helicon, Behringer, Bugera, Auratone und Coolaudio sind Warenzeichen oder eingetragene Warenzeichen der Music Tribe Global Brands Ltd. © Music Tribe Global Brands Ltd. 2019 Alle Rechte vorbehalten.

BESCHRÄNKTE GARANTIE

Die geltenden Garantiebedingungen und zusätzliche Informationen bezüglich der von Music Tribe gewährten beschränkten Garantie finden Sie online unter musictribe.com/warranty.

PT Instruções de Segurança Importantes



Aviso!

Terminais marcados com o símbolo carregam corrente elétrica de magnitude suficiente para constituir um risco de choque elétrico. Use apenas cabos de alto-falantes de alta qualidade com plugues TS de ¼" ou plugues com trava de torção pré-instalados. Todas as outras instalações e modificações devem ser efetuadas por pessoas qualificadas.



Este símbolo, onde quer que o encontre, alerta-o para a leitura das instruções de manuseamento que acompanham o equipamento. Por favor leia o manual de instruções.



Atenção

De forma a diminuir o risco de choque elétrico, não remover a cobertura (ou a secção de trás). Não existem peças substituíveis por parte do utilizador no seu interior. Para esse efeito recorrer a um técnico qualificado.



Atenção

Para reduzir o risco de incêndios ou choques elétricos o aparelho não deve ser exposto à chuva nem à humidade. Além disso, não deve ser sujeito a salpicos, nem devem ser colocados em cima do aparelho objectos contendo líquidos, tais como jarras.



Atenção

Estas instruções de operação devem ser utilizadas, em exclusivo, por técnicos de assistência qualificados. Para evitar choques elétricos não proceda a reparações ou intervenções, que não as indicadas nas instruções de operação, salvo se possuir as qualificações necessárias. Para evitar choques elétricos não proceda a reparações ou intervenções, que não as indicadas nas instruções de operação. Só o deverá fazer se possuir as qualificações necessárias.

1. Leia estas instruções.
2. Guarde estas instruções.
3. Preste atenção a todos os avisos.
4. Siga todas as instruções.
5. Não utilize este dispositivo perto de água.
6. Limpe apenas com um pano seco.
7. Não obstrua as entradas de ventilação. Instale de acordo com as instruções do fabricante.
8. Não instale perto de quaisquer fontes de calor tais como radiadores, bocas de ar quente, fogões de sala ou outros aparelhos (incluindo amplificadores) que produzam calor.
9. Não anule o objectivo de segurança das fichas polarizadas ou do tipo de ligação à terra. Uma ficha polarizada dispõe de duas palhetas sendo uma mais larga do que a outra. Uma ficha do tipo ligação à terra dispõe

de duas palhetas e um terceiro dente de ligação à terra. A palheta larga ou o terceiro dente são fornecidos para sua segurança. Se a ficha fornecida não encaixar na sua tomada, consulte um electricista para a substituição da tomada obsoleta.

10. Proteja o cabo de alimentação de pisadelas ou apertos, especialmente nas fichas, extensões, e no local de saída da unidade. Certifique-se de que o cabo eléctrico está protegido. Verifique particularmente nas fichas, nos receptáculos e no ponto em que o cabo sai do aparelho.

11. O aparelho tem de estar sempre conectado à rede eléctrica com o condutor de protecção intacto.

12. Se utilizar uma ficha de rede principal ou uma tomada de aparelhos para desligar a unidade de funcionamento, esta deve estar sempre acessível.

13. Utilize apenas ligações/acessórios especificados pelo fabricante.



14. Utilize apenas com o carrinho, estrutura, tripé, suporte, ou mesa especificados pelo fabricante ou vendidos com o dispositivo. Quando utilizar um carrinho, tenha cuidado ao

mover o conjunto carrinho/dispositivo para evitar danos provocados pela terpidação.

15. Desligue este dispositivo durante as trovoadas ou quando não for utilizado durante longos períodos de tempo.

16. Qualquer tipo de reparação deve ser sempre efectuado por pessoal qualificado. É necessária uma reparação sempre que a unidade tiver sido de alguma forma danificada, como por exemplo: no caso do cabo de alimentação ou ficha se encontrarem danificados; na eventualidade de líquido ter sido derramado ou objectos terem caído para dentro do dispositivo; no caso da unidade ter estado exposta à chuva ou à humidade; se esta não funcionar normalmente, ou se tiver caído.



17. Correcta eliminação deste produto: este símbolo indica que o produto não deve ser eliminado juntamente com os resíduos domésticos, segundo a Directiva REEE (2012/19/EU) e a legislação nacional. Este produto deverá

ser levado para um centro de recolha licenciado para a reciclagem de resíduos de equipamentos eléctricos e electrónicos (EEE). O tratamento incorrecto deste tipo de resíduos pode ter um eventual impacto negativo no ambiente e na saúde humana devido a substâncias potencialmente perigosas que estão geralmente associadas aos EEE. Ao mesmo tempo, a sua colaboração para a eliminação correcta deste produto irá contribuir para a utilização eficiente dos recursos naturais. Para mais informação acerca dos locais onde poderá deixar o seu equipamento usado para reciclagem, é favor contactar os serviços municipais locais, a entidade de gestão de resíduos ou os serviços de recolha de resíduos domésticos.

18. Não instale em lugares confinados, tais como estantes ou unidades similares.

19. Não coloque fontes de chama, tais como velas acesas, sobre o aparelho.

20. Favor, obedecer os aspectos ambientais de descarte de bateria. Baterias devem ser descartadas em um ponto de coletas de baterias.

21. Use este aparelho em climas tropicais e/ou moderados.

LEGAL RENUNCIANTE

O Music Tribe não se responsabiliza por perda alguma que possa ser sofrida por qualquer pessoa que dependa, seja de maneira completa ou parcial, de qualquer descrição, fotografia, ou declaração aqui contidas. Dados técnicos, aparências e outras informações estão sujeitas a modificações sem aviso prévio. Todas as marcas são propriedade de seus respectivos donos. Midas, Klark Teknik, Lab Gruppen, Lake, Tannoy, Turbosound, TC Electronic, TC Helicon, Behringer, Bugera, Auratone e Coolaudio são marcas ou marcas registradas do Music Tribe Global Brands Ltd. © Music Tribe Global Brands Ltd. 2019 Todos direitos reservados.

GARANTIA LIMITADA

Para obter os termos de garantia aplicáveis e condições e informações adicionais a respeito da garantia limitada do Music Tribe, favor verificar detalhes na íntegra através do website musictribe.com/warranty.

JP 安全にお使いいただくために



注意

感電の恐れがありますので、カバーやその他の部品を取り外したり、開けたりしないでください。高品質なプロ用スピーカーケーブル (¼" TS 標準ケーブルおよびツイスト ロッキング プラグケーブル) を使用してください。



注意

火事および感電の危険を防ぐため、本装置を水分や湿気のあるところには設置しないで下さい。装置には決して水分がかからないように注意し、花瓶など水分を含んだものは、装置の上には置かないようにしてください。



注意

このマークが表示されている箇所には、内部に高圧電流が生じています。手を触れると感電の恐れがあります。



注意

取り扱いとお手入れの方法についての重要な説明が付属の取扱説明書に記載されています。ご使用前に良くお読みください。



注意

1. 取扱説明書を通してご覧ください。
2. 取扱説明書を大切に保管してください。
3. 警告に従ってください。
4. 指示に従ってください。
5. 本機を水の近くで使用しないでください。
6. お手入れの際は常に乾燥した布巾を使ってください。
7. 本機は、取扱説明書の指示に従い、適切な換気を妨げない場所に設置してください。取扱説明書に従って設置してください。
8. 本機は、電気ヒーターや温風機器、ストーブ、調理台やアンプといった熱源から離して設置してください。

9. ニ極式プラグおよびアースタイプ (三芯) プラグの安全ピンは取り外さないでください。ニ極式プラグにはピンが二本ついており、そのうち一本はもう一方よりも幅が広がっています。アースタイプの三芯プラグには二本のピンに加えてアース用のピンが一本ついています。これらの幅の広いピン、およびアースピンは、安全のためのものです。備え付けのプラグが、お使いのコンセントの形状と異なる場合は、電器技師に相談してコンセントの交換をして下さい。

10. 電源コードを踏みつけたり、挟んだりしないようご注意ください。電源コードやプラグ、コンセント及び製品との接続には十分にご注意ください。

11. すべての装置の接地 (アース) が確保されていることを確認して下さい。



12. 電源タップや電源プラグは電源遮断機として利用されている場合には、これが直ぐに操作できるように手元に設置して下さい。

13. 付属品は本機製造元が指定したもののみをお使いください。

14. カートスタンド、三脚、ブラケット、テーブルなどは、本機製造元が指定したものの、もしくは本機の付属品となるもののみをお使いください。カートを使用時の運搬の際は、器具の落下による怪我に十分ご注意ください。

15. 雷雨の場合、もしくは長期間ご使用にならない場合は、電源プラグをコンセントから抜いてください。

16. 故障の際は当社指定のサービス技術者にお問い合わせください。電源コードもしくはプラグの損傷、液体の装置内への浸入、装置の上に物が落下した場合、雨や湿気に装置が晒されてしまった場合、正常に作動しない場合、もしくは装置を地面に落下させてしまった場合など、いかなる形であれ装置に損傷が加わった場合は、装置の修理・点検を受けてください。

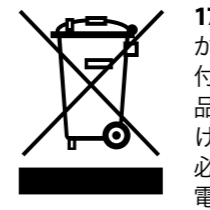

17. 本製品に電源コードが付属されている場合、付属の電源コードは本製品以外ではご使用いたしません。電源コードは必ず本製品に付属された電源コードのみご使用ください。

18. ブックケースなどのような、閉じたスペースには設置しないでください。

19. 本機の上に点火した蝋燭などの裸火を置かないでください。

20. 電池廃棄の際には、環境へのご配慮をお願いします。電池は、かならず電池回収場所に廃棄してください。

21. 本機器は熱帯気候および / または温帯気候下でご使用ください。

法的放棄

ここに含まれる記述、写真、意見の全体または一部に依拠して、いかなる人が損害を生じさせた場合にも、Music Tribe は一切の賠償責任を負いません。技術仕様、外観およびその他の情報は予告なく変更になる場合があります。商標はすべて、それぞれの所有者に帰属します。Midas, Klark Teknik, Lab Gruppen, Lake, Tannoy, Turbosound, TC Electronic, TC Helicon, Behringer, Bugera, Auratone および Coolaudio は Music Tribe Global Brands Ltd. の商標または登録商標です。© Music Tribe Global Brands Ltd. 2019 無断転用禁止。

限定保証

適用される保証条件と Music Tribe の限定保証に関する概要については、オンライン上 musictribe.com/warranty にて詳細をご確認ください。

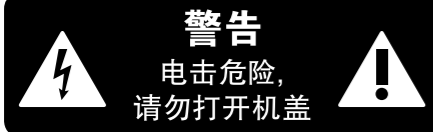
CN 其他的重要信息

 带有此标志的终端设备具有强大的电流, 存在触电危险。仅限使用带有 ¼" TS 或扭锁式插头的高品质专业扬声器线。所有的安装或调整均须由合格的专业人员进行。

 此标志提醒您, 产品内存在未绝缘的危险电压, 有触电危险。

 此标志提醒您查阅所附的重要的使用及维修说明。请阅读有关手册。

 **小心**
为避免触电危险, 请勿打开机顶盖 (或背面挡板)。设备内没有可供用户维修使用的部件。请将维修事项交由合格的专业人员进行。

 **小心**
为避免着火或触电危险, 请勿将此设备置于雨淋或潮湿中。此设备也不可受液体滴溅, 盛有液体的容器也不可置于其上, 如花瓶等。

 **小心**
维修说明仅是给合格的专业维修人员使用的。为避免触电危险, 除了使用说明书提到的以外, 请勿进行任何其它维修。所有维修均须由合格的专业人员进行。

1. 请阅读这些说明。
2. 请妥善保存这些说明。
3. 请注意所有的警示。
4. 请遵守所有的说明。
5. 请勿在靠近水的地方使用本产品。
6. 请用干布清洁本产品。
7. 请勿堵塞通风口。安装本产品时请遵照厂家的说明。
8. 请勿将本产品安装在热源附近, 如暖气片, 炉子或其它产生热量的设备 (包括功放器)。
9. 请勿移除极性插头或接地插头的安全装置。接地插头是由两个插塞接点及一个接地头构成。若随货提供的插头不适合您的插座, 请找电工更换一个合适的插座。
10. 妥善保护电源线, 使其不被践踏或刺破, 尤其注意电源插头、多用途插座及设备连接处。

11. 请只使用厂家指定的附属设备和配件。



12. 请只使用厂家指定的或随货销售的手推车, 架子, 三角架, 支架和桌子。若使用手推车来搬运设备, 请注意安全放置设备, 以避免手推车和设备

倾倒而受伤。

13. 遇闪电雷鸣或长期不使用本设备时, 请拔出电源插头。

14. 所有维修均须由合格的维修人员进行。设备受损时需进行维修, 例如电源线或电源插头受损, 液体流入或异物落入设备内, 设备遭雨淋或受潮, 设备不能正常运作或被摔坏。

15. 本设备连接电源时一定要接地保护。

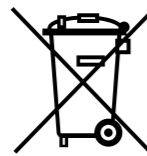

16. 若电源插头或器具耦合器用作断电装置, 应当保证它们处于随时可方便操作状态。

17. 本产品仅适用于海拔 2000 米以下地区, 本产品仅适用于非热带气候条件下。

**法律声明**

对于任何因在此说明书提到的全部或部分描述、图片或声明而造成的损失, Music Tribe 不负任何责任。技术参数和外观若有更改, 恕不另行通知。所有的商标均为其各自所有者的财产。Midas, Klark Teknik, Lab Gruppen, Lake, Tannoy, Turbosound, TC Electronic, TC Helicon, Behringer, Bugera, Auratone 和 Coolaudio 是 Music Tribe Global Brands Ltd. 公司的商标或注册商标。© Music Tribe Global Brands Ltd. 2019 版权所有。

保修条款

有关音乐集团保修的适用条款及其它相关信息, 请登陆 musictribe.com/warranty 网站查看完整的详细信息。

1. Introduction

1.1 Welcome

Thank you for choosing a Lab.gruppen PDX Series product. This manual provides a comprehensive guide to the features and functionality of PDX Series model PDX3000 and PDX2000 amplifiers. We highly recommend you read through this manual in its entirety to become fully acquainted with configuration options and protection circuitry. As you become thoroughly familiar with all aspects of operation, you may learn of features or options that will affect your choices on amplifier modes or loudspeaker system configuration.

Lab.gruppen PDX Series power amplifiers are designed and built with competitive price and good performance and protection features in mind. Although the PDX Series features a competitive price, each amplifier draws on the engineering that has made Lab.gruppen the benchmark of quality for touring concert systems: exceptional sonic performance, rugged construction, proven reliability, and protection features that anticipate every unwelcome possibility – that is the core of the “Show must go on” design philosophy that every Lab.gruppen product is created with, with a well matched feature set per product range depending on the expected application. This manual was created for the PDX Series 3000 and 2000 amplifier models. Any references to “PDX Series” in this manual refer to all models in the range.

1.2 Features

Your new PDX Series amplifier incorporates a number of sophisticated technologies – many of them proprietary to Lab.gruppen – that ensure the best possible performance and years of reliable operation. Familiarizing yourself with these technologies will prove invaluable in setting up and optimizing your loudspeaker system.

1.3 Class D output stage

All PDX Series amplifiers employ our unique IDEEA Class D output stage that is ideally matched to the rated power output. To provide flexibility, each channel offers sufficient voltage swing and current capacity to drive loads in any impedance without any additional configuration. In order to have low thermal losses as well as a high voltage swing, the design is based on a permanently bridged output.

1.4 Protection and performance optimization

Appropriate and reliable power amplification is vital to any audio system. Inadequate or faulty power amplifiers could cause damage to loudspeakers, or in some cases to the power amplifiers themselves. To prevent damage or service interruptions, PDX Series amplifiers offer advanced features to protect both internal circuits and connected loads. These features are part of the Lab.gruppen philosophy “Show must go on”.

Standard on the PDX Series protection features include:

- **CPL (Current Peak Limiter)** ensures that the amplifier’s output does not exceed the safe current handling parameters of the amplifier components.
- **Temperature protection** ensures that the amplifier will not be damaged by exceeding thermal limits. The RDY LED flashes orange when the amplifier approaches thermal limits to allow user action before protective muting engages.
- **DC protection** ensures destructive DC signals will not appear at the amplifier outputs. If such conditions occur an internal fuse opens.
- **RSL (Rail Sensing Limiter)** is applied to avoid distortion at the selected voltage limit threshold and to avoid hitting the rail if it has sagged below the configured threshold. Limiting also may be applied when maximum output current has been reached or when the mains voltage is too low to maintain required rail voltage. Limiting activity is shown by the front panel Limiter LED

1.5 DSP features and PDX controller software

PDX series feature a comprehensive DSP functions such as crossover, parametric EQ, delay, limiter, dynamic EQ and input mixing, making the PDX series suitable for a broad range of installed and touring applications. The PDX series can be controlled through the usage of front panel or PDX Controller software by connecting to a PC with USB.

1.6 Unpacking and visual checks

Every Lab.gruppen amplifier is carefully tested and inspected before leaving the factory and should arrive in perfect condition. If any damage is discovered, please notify the shipping carrier immediately.

Save the packing materials for the carrier’s inspection and for any future shipping.

1.7 Cooling

The PDX Series devices use a forced-air cooling system with front to rear airflow, allowing high continuous power levels without thermal problems.

Please ensure that there is sufficient space in the front and rear of each amplifier to allow free flow of air, no doors or covers should be mounted either in the front or rear of the amplifiers.

Amplifiers may be stacked directly on top of each other with no spacing, though some spacing may enable more convenient installation of rear cabling.

Fit solid blanks (not ventilation blanks) to unused rack spaces to ensure effective air circulation. Leaving gaps in between items of equipment degrades the effectiveness of forced-air cooling.

1.8 Operating voltage

Always connect your PDX amplifier to the voltage specified on the rear of the device. Connecting the amp to an incorrect voltage can permanently damage your amp.

- USA / Canada / Japan = 100-120 V~, 50/60 Hz
- UK / Australia / Europe / Korea / China 220-240 V~, 50/60 Hz

The locking IEC receptacle on the rear panel accepts the supplied IEC cord which terminates in a connector appropriate for the country of sale.

2. Control

2.1 Front Panel

The following indicators and controls are available on the front panel (Fig. 1):

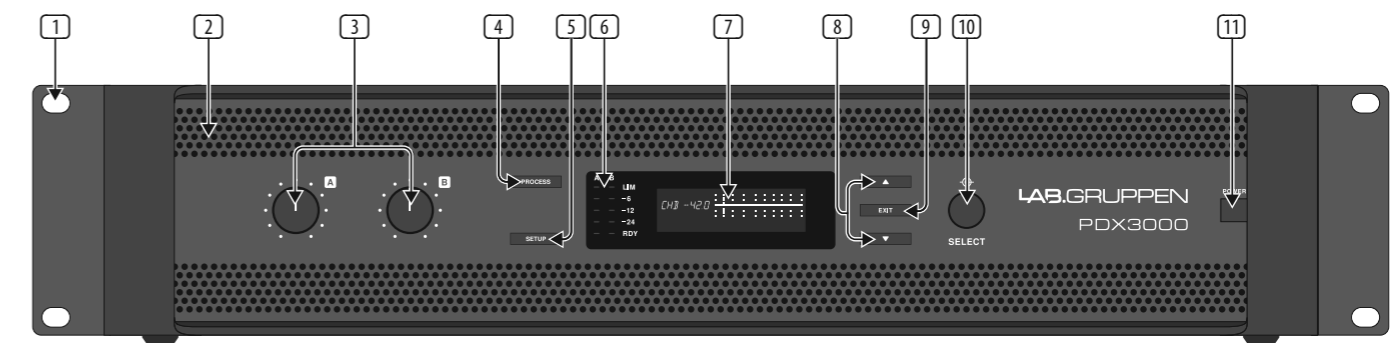

Fig. 1: PDX3000 Front Panel

- RACK EARS** secure the unit into a rack using four attaching screws and washers (fasteners not included). The height requires two rack units.
- VENTILATION** openings allow front-to-rear air circulation to prevent overheating.
- INPUT CONTROLS** adjust the input level for each channel. To attenuate the input signal, rotate the knobs counter-clockwise.
- PROCESS** button steps through the DSP processing modules.
- SETUP** button accesses basic device configuration functions such as presets, panel lock, device name and screen contrast.
- LEVEL LEDs** display the signal level for each channel. Reduce the input gain if a channel’s red LIM LED lights up continuously.
- LCD SCREEN** displays the current DSP module and parameter settings.
- UP/DOWN** buttons navigates through menus by stepping up/down through parameters.
- EXIT** button acts as a “back” button and takes you back one step in the menu hierarchy per press.
- SELECT** encoder knob toggles between Graphic and Edit modes (when pressed) and changes parameter values (when rotated).
- POWER** button turns the amplifier on and off.

2.2 Rear Panel

The following connectors are available on the rear panel (Fig. 2):

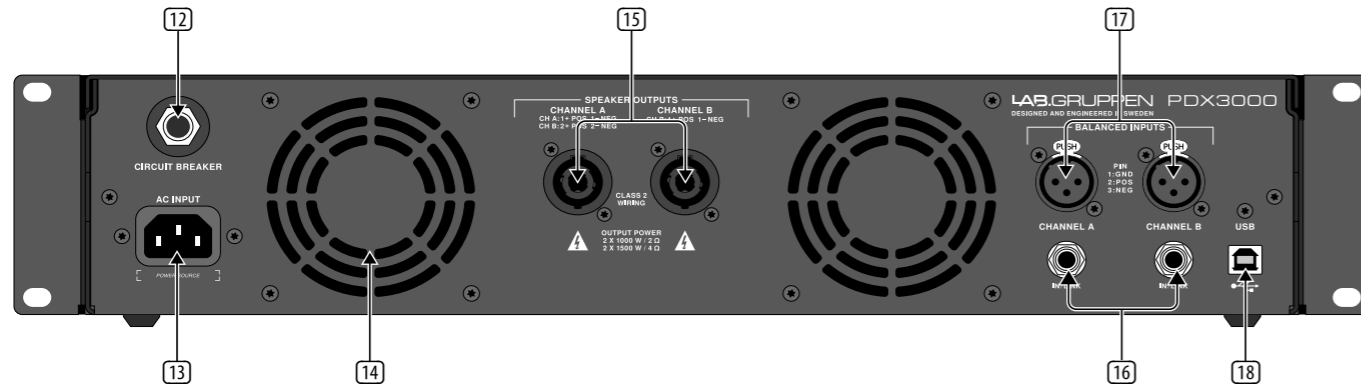

Fig. 2: PDX3000 Rear Panel

12 **BREAKER** (automated fuse) acts in place of common discardable fuses. After eliminating the cause of faulty operation, simply depress the BREAKER and power up the unit again.

BREAKER WARNING: Take the following actions BEFORE resetting the breaker:

- Unplug the AC main cable
- Press the POWER button to the extended "OFF" position
- Turn all input gain control elements down
- And then, reset the breaker, connect the unit to the mains, switch ON and slowly increase the gain to the target volume.

13 **POWER SOURCE** locking connector accepts the included IEC power cord.

14 **VENTILATION FAN** speed adjusts automatically depending on temperature to ensure trouble-free operation.

15 **SPEAKER OUTPUTS** connect the amplifier to the speakers using professional speaker cables with twist-locking speakON plugs. Both output channels are available by using a 4-pole connector and cable with the CHANNEL A output. CHANNEL B is available separately on the right-hand CHANNEL B output.

WARNING! Bridge Mode is not supported!

WARNING! Do not connect any output connector poles to ground!

16 **BALANCED INPUTS (1/4" connections)** accept audio inputs for each channel from audio cables with 1/4" TRS connectors (balanced) or 1/4" TS connectors (unbalanced).

17 **BALANCED INPUTS (XLR connections)** accept balanced audio inputs for each channel from audio cables with XLR connectors.

NOTE: The XLR and 1/4" connections in the BALANCED INPUTS section are physically linked, and users can use this physical connection to route a copy of the input signal to an additional amplifier. For example, a signal coming in to Channel A through the XLR connection can be split and routed back out over Channel A's 1/4" TRS connection.

18 **USB** connection enables firmware updates and control over parameters via computer. Please visit labgruppen.com to download the PDX Controller software for your computer.

3. DSP Configuration

3.1 Default configuration

PDX Series amplifiers are shipped with default DSP settings that allow immediate use in many common applications with no need for further DSP configuration.

The default mode is suited for use with stereo program material into fullrange loudspeakers.

3.2 Signal flow block diagram

The block diagrams below (Fig. 3) show the available signal-flow configurations from inputs to outputs.

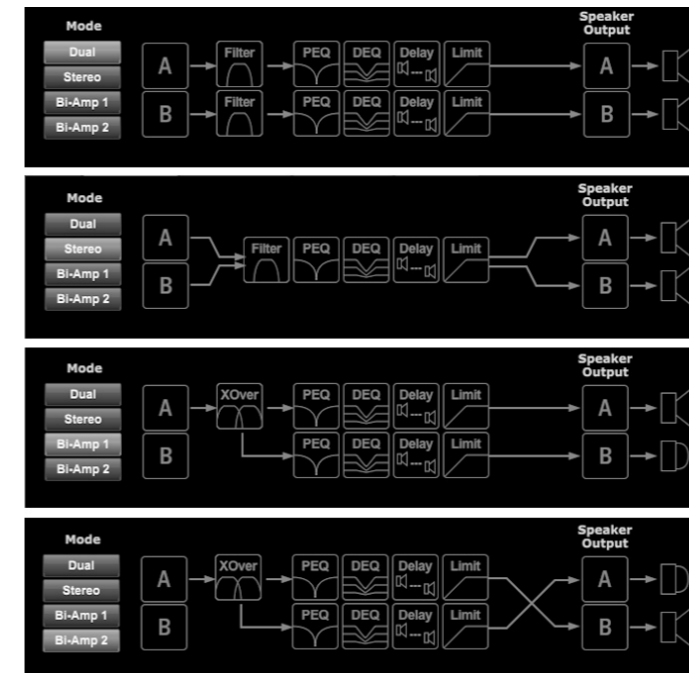

Fig. 3: Available Signal-Flow Configurations

All of these configurations are available through both the Front Panel interface (see pg. 14) and the PDX Controller software (see pg. 22).

3.3 Front panel configuration

Input mixing and routing, as well as all DSP parameters, may be configured using the PROCESS button, SETUP button, UP/DOWN buttons, EXIT button and the SELECT rotary encoder. The following menu tree (Fig. 4) is keyed to points in the signal flow.

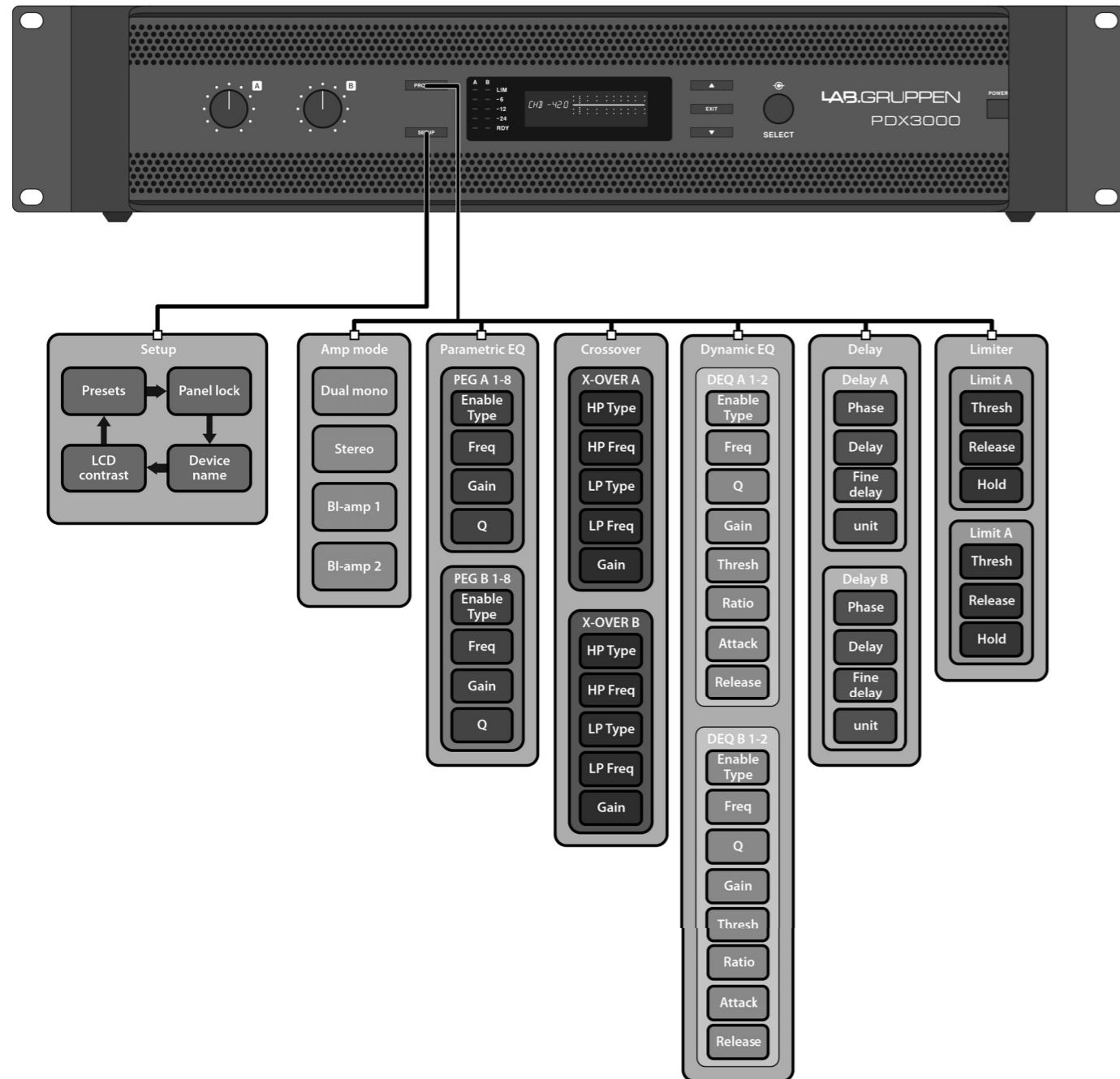

Fig. 4: Front Panel Menu Tree

4. DSP Processor

4.1 Processor Functionality

The PDX DSP processor manipulates your signal in the digital domain, offering tremendous flexibility and control. You may control and program the DSP processor via either the PDX amplifier's front panel or remotely by computer using the PDX Controller software (available for download from labgruppen.com).

By using the DSP processor, you can program all amplifier functions and parameters—except for the CH A and CH B input attenuation settings, which can only be controlled using the CH A / CH B knobs on the amplifier's front panel.

4.2 Front Panel control

The following material describes the DSP's screen organization and how to program the processor's various functions by manipulating your PDX amplifier's front panel controls.

Main top-level screen

The top-level screen displays the model name for your specific unit..



4.3 SETUP screens

The SETUP screens access the preset, panel lock, device naming, and LCD screen contrast functions. To access these functions, press the SETUP button, and then move up and down through the top-level screens by pressing either the SETUP button or the UP / DOWN arrow buttons.

4.3.1 SETUP 1/4: Load Preset

The top-level Load Preset screen displays the current Preset name (up to 10 characters) and Preset number (1–20). Subsidiary screens offer options for loading, saving, and naming Presets.

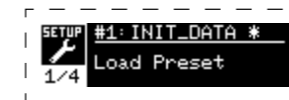

Below the Preset name, this screen displays the "Load Preset" option by default. Rotate the SELECT encoder clockwise to access the "Save Preset" option.

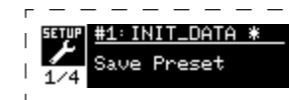

Note: Preset #1:INIT_DATA cannot be overwritten. Select this preset any time you want to restore the amp's default settings.

Loading a Preset

1. Make sure the "Load Preset" option appears on the screen. (Rotate the SELECT encoder to toggle between "Load Preset" and "Save Preset.")

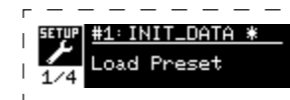

2. Press the SELECT encoder knob to access the DSP's internal Preset list on the next sub-screen. The correct sub-screen will display the LOAD PRESET option in the upper right-hand corner of the screen.
3. Scroll up and down through the Preset list by rotating the SELECT encoder knob. As you scroll, the Preset number will appear to the left below the disk icon.
4. To load the selected Preset, you may either press the SELECT encoder or press the UP arrow button.

Saving a preset

1. Make sure the “Save Preset” option appears on the screen. (Rotate the SELECT encoder to toggle between “Load Preset” and “Save Preset.”)



2. Press the SELECT encoder knob to access the DSP's internal Preset list on the next sub-screen. The correct sub-screen will display the EDIT TITLE and SAVE PRESET options on the right-hand side of the screen.

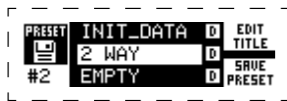

3. Scroll through the list until you find an EMPTY Preset slot or another Preset you wish to overwrite.
4. If you wish to edit your Preset title before saving, press the UP arrow button to choose the EDIT TITLE option.

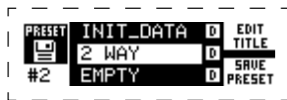

5. Edit the Preset title (see “Editing the Preset” title below).
6. Select the SAVE PRESET option by pressing the DOWN arrow key.

Editing a Preset title

1. Make sure the “Save Preset” option appears on the screen. (Rotate the SELECT encoder to toggle between “Load Preset” and “Save Preset.”)

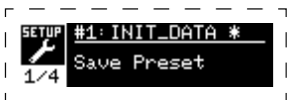

2. Press the SELECT encoder knob to access the DSP's internal Preset list on the next sub-screen. The correct sub-screen will display the EDIT TITLE and SAVE PRESET options on the right-hand side of the screen.

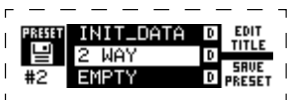

3. Scroll through the Preset list by rotating the SELECT encoder knob.
4. Select a Preset slot as a save destination by pressing the SELECT encoder knob.
5. Press the UP arrow button to select the EDIT TITLE function. The EDIT TITLE window will appear, with alphanumeric characters in a row at the top and the current title directly below with the editing cursor.

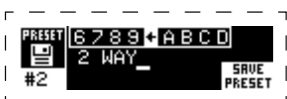

6. Select the backward arrow from the row of characters by rotating the SELECT knob until the backward arrow is highlighted.
7. Press the SELECT encoder knob to erase characters. The cursor will erase characters from right to left across the existing title.
8. Rotate the SELECT encoder to select new characters from the row above the current Preset title.
9. Insert selected characters into the Preset title by pressing the SELECT encoder knob. Once you select and insert a character, the editing cursor will change direction and advance from left to right.
10. Save the new Preset title by pressing the DOWN arrow key to activate the SAVE PRESET function.

4.3.2 SETUP 2/4: Panel Lock

The Panel Lock function uses a 4-character alphanumeric access code to lock the front panel controls and prevent unauthorized changes to DSP settings. Current settings can still be viewed while the unit is locked, but the parameters cannot be changed.

The amplifier can only be locked or unlocked from the Panel Lock screen.

Locking the amplifier

1. Go to the Panel Lock screen by pressing the SETUP button.
2. Press the SELECT encoder knob to access the password screen.

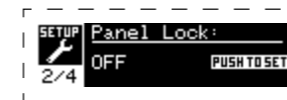

3. Set an access code by using the SELECT encoder knob. Rotate the knob to scroll through the character list, and then select characters by pressing. With each press on the SELECT encoder knob, the password cursor will advance left to right by one space.



4. The amplifier will automatically lock when you select the final character for the access code. The display will flash a brief confirmation message: “Device Locked!”
5. The status displayed on the Panel Lock screen will state “LOCKED!”

Unlocking the amplifier

1. Go to the Panel Lock screen by pressing the SETUP button.
2. Press the SELECT encoder knob to access the password screen.
3. Enter the access code by using the SELECT encoder knob. Rotate the knob to scroll through the character list, and then select characters by pressing. With each press on the SELECT encoder knob, the password cursor will advance left to right by one space.
4. The amplifier will automatically unlock when you select the final character for the access code. The display will flash a brief confirmation message: “Unlocked.”
5. The status displayed on the Panel Lock screen will state “OFF.”

NOTE: Connecting the amplifier to a PC via USB allows the user to unlock the device should the password be forgotten. This function is performed through the PDX Controller software.

4.3.3 SETUP 3/4: Device Name

Each PDX DSP amplifier can be individually named for easy identification within a rack or remotely via the PDX Controller software.

Naming the amplifier

1. Access the Device Name screen by pressing the SETUP button.

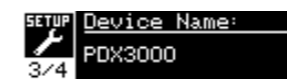

2. Press the SELECT encoder knob to access the editing screen.

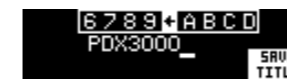

3. Choose the backwards arrow by turning the SELECT knob and press it to delete the existing characters of the current preset name.
4. Rotate the SELECT encoder to select new characters from the row above the current amplifier name.
5. Insert selected characters into the new amplifier name by pressing the SELECT encoder knob. Once you select and insert a character, the editing cursor will change direction and advance from left to right.
6. Save the new amplifier name by pressing the DOWN arrow key to activate the SAVE TITLE function.

4.3.4 SETUP 4/4: Contrast

The Contrast screen allows you to adjust the LCD screen's contrast level. The Contrast parameter ranges from 1–30, with 30 representing maximum contrast. Rotate the SELECT encoder knob to adjust the Contrast setting.

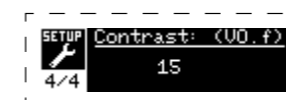

4.4 PROCESS screens

Pressing the PROCESS button opens up the various screens that determine the signal path setup and that control processing parameters for the DSP modules: I/O, PEQ, XOVER, DEQ, DELAY, and LIMIT.

You can move between top-level module screens by pressing the PROCESS button.

4.4.1 I/O

The I/O module sets up the signal routing inside the DSP from input to output. Press and rotate the SELECT encoder knob to choose between dual mono, stereo, or bi-amped options.

DUAL

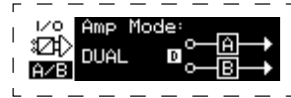

DUAL (dual mono) mode routes each channel input, A and B, through completely separate parallel signal paths with independent outputs for each channel. Each channel may be processed with its own unique filter, equalization, signal delay, and limiter settings.

STEREO



STEREO mode routes the signal from both the A and B inputs through a single series of DSP modules. The parallel DSP modules process the A and B signals with identical, linked settings (only module "A" parameter settings appear on subsequent DSP module screens).

BIAMP1



BIAMP1 mode splits the Channel A input signal at a programmable frequency point, and then routes the resulting high and low frequency signals through a parallel chain of DSP modules with independent equalization, signal delay, and limiter settings. In BIAMP1 mode, Output A routes low frequencies to a low-range speaker, while Output B connects to a high-frequency transducer.

BIAMP2



BIAMP2 mode operates identically to BIAMP1 mode, except that the output signals are swapped between Outputs A and B (i.e., Output B handles low frequencies while Output A handles high frequencies). The swapped A and B output routing allows the user to quickly correct reversed high/low speaker connections without having to physically access the amplifier's back panel and manually change the speaker connection.

4.4.2 PEQ

The PEQ module deploys up to eight EQ bands for precise sound sculpting. The EQ bands can each be switched between low shelving, high shelving, and parametric modes. For the high shelving and low shelving EQ bands, the LS12 and HS12 settings provide steeper equalization curves than the LS6 and HS6 settings.

The main PEQ screen displays the composite equalization curve across the frequency spectrum.



Programming equalizers

1. Choose individual equalizers by rotating the SELECT encoder knob. As you rotate the SELECT encoder knob, dotted vertical lines will appear at different points within the frequency spectrum, and the EQ band name will appear in the lower-left corner of the screen (e.g., A#1, A#2, B#1, B#2, and so on).



2. Press the SELECT encoder knob to enter the parameter screens for your chosen EQ band.
3. Press the UP / DOWN arrow keys to switch between parameters. The chosen parameter will appear highlighted.
4. Rotate the SELECT encoder knob to change parameter values.
5. Choose the equalizer type (Type): OFF, PEQ (parametric), low shelving (LS6, LS12), or high shelving (HS6, HS12).

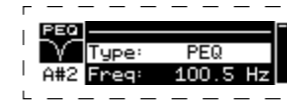

6. Set the frequency (Freq) for each EQ band by rotating the SELECT encoder knob. The programmed frequency can represent either the center frequency for parametric mode, or the cutoff frequency for low and high shelving modes.

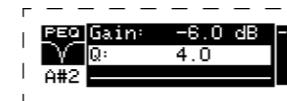

7. Set the EQ band's cut or boost (Gain) by rotating the SELECT encoder knob.
8. For parametric mode, control the width of the parametric curve by tweaking the Q parameter. High Q values produce a narrow, steep curve, while low Q values create a wide curve with a gentle slope.
9. Press the SELECT encoder knob or the EXIT button to return to the top-level PEQ screen.

4.4.3 XOVER

The XOVER module offers programmable pairs of high- and low-pass filters. STEREO mode offers only one filter set (A#1). DUAL, BIAMP1, and BIAMP2 modes use two filter sets (A#1 and B#1), and in BIAMP1 and BIAMP2 modes, these two sets of filters may be linked.

On the top-level screen, vertical dotted lines indicate the threshold point for each filter.



Each low-pass and high-pass filter also offers multiple options for filter type and slope: OFF, Butterworth (BUT6, BUT12, BUT18, BUT24, BUT48), Bessel (BES12, BES24), or Linkwitz-Riley (LR12, LR24, LR48).

Programming filters/bi-amping crossover

1. Choose between filter sets A#1 and B#1 by rotating the SELECT encoder knob (DUAL, BIAMP1, and BIAMP2 modes only).
2. Press the SELECT encoder knob to enter the parameter screens.
3. Move up or down between parameters by pressing the UP / DOWN arrow buttons.
4. Choose between filter types for high-pass (HPtype) and low-pass (LPtype) by rotating the SELECT encoder knob.

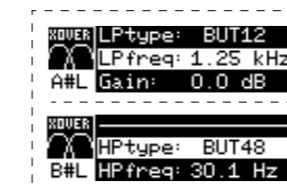

5. Set the filter thresholds for high-pass (HPfreq) and low-pass (LPfreq) by rotating the SELECT encoder knob.

EN

- Set the filter's overall signal gain (Gain) by rotating the SELECT encoder knob.

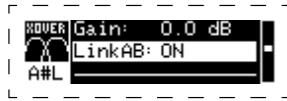

- Set the link parameter (LinkAB) to ON or OFF by rotating the SELECT encoder knob (BIAMP1 and BIAMP2 modes only).
- Press the SELECT encoder when finished to return to the top-level XOVER screen.

4.4.4 DEQ

The DEQ module deploys a dynamic EQ that is triggered by a programmable signal threshold. For example, you can program the dynamic EQ to cut or boost increasing amounts of mid frequencies as the signal gets louder beyond your preferred threshold.

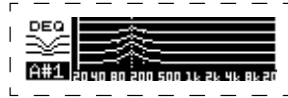

STEREO mode features one set of dynamic EQs (A#1 and A#2), while DUAL, BIAMP1, and BIAMP2 modes feature two sets of dynamic EQs (A#1, A#2, B#1, and B#2). Each dynamic EQ may be set to OFF, band-pass (BP), low-pass (LP6, LP12), and high-pass (HP6, HP12).

Programming dynamic EQs

- Choose between dynamic EQ sets by rotating the SELECT encoder knob.
- Press the SELECT encoder knob to enter the parameter screens.
- Move up or down between parameters by pressing the UP / DOWN arrow buttons.
- Choose between EQ types (Type) by rotating the SELECT encoder knob.

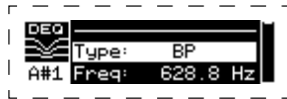

- Set the frequency (Freq) for each EQ by rotating the SELECT encoder knob. The programmed frequency can represent either the center frequency for band-pass mode, or the threshold frequency for low- and high-pass modes.
- For band-pass mode, control the width of the band-pass curve by tweaking the Q parameter. High Q values produce a narrow, steep curve, while low Q values create a wide curve with a gentle slope.

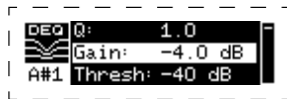

- Set the dynamic equalizer's cut or boost (Gain) by rotating the SELECT encoder knob.
- Set the signal threshold (Thresh) by rotating the SELECT encoder knob.
- Program your desired ratio (Ratio). Similar to a compressor, higher ratio values yield a more intense equalization effect.
- Adjust attack (Atime) and release (Rtime) to your preferred values.

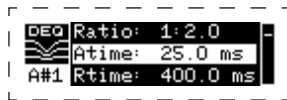

- Press the SELECT encoder when finished to return to the top-level DEQ screen.

4.4.5 DELAY

The DELAY DSP module digitally slows the final signal output from the amplifier by a programmable amount (expressed as either distance or time). This signal delay helps prevent phase and synchronization problems caused by sound traveling through air over long distances, e.g., between speaker arrays separated by long distances or between a performance stage and distant sound reinforcement speakers.



Programming signal delay

- Choose between signal paths (A#1, B#1) by rotating the SELECT encoder knob.
- Press the SELECT encoder knob to enter the parameter screens.
- Move up or down between parameters by pressing the UP / DOWN arrow buttons.
- Choose between 0° and 180° phase (PHASE) by rotating the SELECT encoder knob.

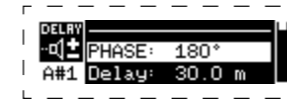

- Choose your amount of signal delay (Delay) by rotating the SELECT encoder button.
- Fine tune the Delay value using the (fine) parameter.

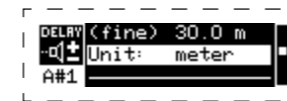

- Change the delay's unit of measure (Unit), if necessary, by rotating the SELECT encoder knob. The delay value can be expressed in milliseconds (ms), meters (m), or feet (ft).
- Press the SELECT encoder when finished to return to the top-level DELAY screen.

4.4.6 LIMIT

The LIMIT DSP module controls the unit's output limiter, with programmable parameters for threshold (Thresh), release (Rtime), and hold (Hold).

The top-level LIMIT screen always displays the threshold (Thresh) setting for quick reference.

Programming the output limiter

- Choose between signal paths (A#1, B#1) by rotating the SELECT encoder knob.
- Press the SELECT encoder knob to enter the parameter screens.
- Move up or down between parameters by pressing the UP / DOWN arrow buttons.
- Choose a threshold (Thres) setting by rotating the SELECT encoder knob.
- Choose a release time (Rtime) by rotating the SELECT encoder knob.
- Choose a hold (Hold) setting by rotating the SELECT encoder knob.
- Press the SELECT encoder when finished to return to the top-level LIMIT screen.

EN

5. PDX Controller Software



The PDX Controller software allows the user to control all PDX DSP settings remotely from a computer via the USB connection located on the PDX rear panel.

5.1 Meters

Monitor input and output levels by using the virtual meters on the right hand side of the control software screen. Adjust input levels using the knobs on the amplifier's front panel.

5.1.1 Input/Output Meters



The input meters show the signal level at the CH A and CH B inputs. If the input signal exceeds the 0 dB level, the red Clip indicator will light over the channel experiencing an overload.

The input level can only be controlled by using the CH A and CH B knobs on the front panel of the PDX amplifier. The PDX Controller software does not control the input level.

5.2 Connection Status

The software displays the connection status in the top header of the main software window.

PDX Controller [not connected!]

When the amp/software connection is active, the window heading displays the name of the amplifier.

PDX Controller [Device: PDX3000]

5.3 Function Tabs

The PDX Controller window allows the user to access DSP functions via embedded tabs accessible near the top of the software window.



The software window includes these tabbed screens:

- **Setup**—manages presets and networking options.
- **Configuration**—controls the amplifier Mode setting for Dual Mono, Stereo, and other routing options, as well setting controls for output delay and limiting.
- **Filter/Crossover**—offers control over adjustable hi-pass and lo-pass filters. In Bi-Amp 1 and Bi-Amp 2 configuration, this tab controls the crossover point for splitting the blended, mono input signal into separate high- and low-frequency mono signals for bi-amping.
- **Parametric EQ**—controls up to 8 adjustable parametric and shelving EQs for each channel.
- **Dynamic EQ**—adjusts parameters for 2 bands of level-dependent, dynamic equalization per channel.

5.3.1 Setup



The Setup tab allows you to manage connections and settings for your PDX amps. Amp presets may be stored either on the PDX DSP or on the PC (presets stored on your PC may then be loaded onto any PDX amplifier).

PC Presets

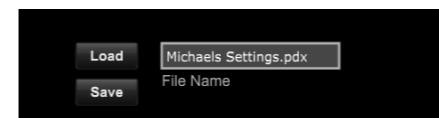

The PC Presets section allows you to store PDX DSP presets on your computer instead of the PDX amp's internal memory. The Load function allows you to upload presets from the computer, while the Save function stores the current PDX DSP settings to the computer (these files use a .pdx filename extension).

Amp Presets



The Amp Presets section allows you to access and manage presets stored in the PDX amp's internal memory. The amp's internal memory holds up to 20 presets, and these 20 preset slots appear in the Amp Presets section as a numbered, double-column list showing the preset name and the preset's signal routing configuration (DUAL, STEREO, BIAMP1, and so on). The preset currently in use will display an illuminated dot immediately to the preset's left.

Note: Preset #1:INIT_DATA cannot be overwritten. Select this preset any time you want to restore the amp's default settings.

Recalling a preset stored in the amp's internal memory

1. Click on the desired preset in the Amp Presets list. The dot to the immediate left of the selected preset will light up.
2. Click on the Recall button in the upper left of the Amp Presets section. The selected preset's name will appear in the text box next to the Recall button. All settings contained in the preset will automatically deploy.

Saving a preset to the amp's internal memory

1. Select a destination for the preset by clicking on a slot in the preset list. (If you save your preset to a slot already holding a stored preset, the stored preset will be replaced by your new preset.)
2. Type your new preset's name into the text box to the right of the Recall button.
3. Click on the Store button to store your preset in the selected slot in the preset list. Your new preset's name will appear in the selected slot in the preset list.

Amp Connection



The Amp Connection section tells you which PDX amplifier you have connected to the software, as well as options for naming your PDX amp and for setting up a code to lock the amplifier's front panel and prevent tampering (the amp can still be edited from your laptop using the PDX Controller software).

For the current edition of the PDX Controller software, only one PDX amplifier can appear at any one time in the amplifier list and be recognized by the software.

Connecting to an amplifier

♦ this procedure assumes you already have a PDX amplifier connected to your computer, and that you are switching to another PDX amplifier. Usually, the PDX Controller software will automatically detect a USB-connected PDX amp and then ask if you wish to connect to the detected amplifier.

1. Click on the Connect button near the bottom of the Amp Connection section of the Setup tab. The software will disconnect from the current amplifier, clear the amplifier from the list in the Amp Connection section, and clear all presets from the Amp Presets list.
2. Press the Refresh button near the top of the Amp Connection section, above and to the left of the amplifier list window. When the software finds your newly-connected PDX amp, the amplifier will appear in the amplifier list window, and the amp's internal presets will populate the Amp Presets list. The software will also launch a confirmation window asking if you wish to connect to the detected amplifier.
3. Press the Connect button in the confirmation window to finalize the connection.

Renaming an amplifier

1. Type the new amplifier name directly into the text box to the left of the Rename Amp virtual button near the bottom of the Amp Connection section.
2. Click on the Rename Amp virtual button. The new amplifier name will appear in the Amp Name column of the amplifier list.

Locking the amplifier

1. Type a 4-character lock code of your choosing directly into the Lock Code window near the bottom of the Amp Connection section. The Lock function requires a new lock code every time you lock the amplifier.
2. Click on the Lock virtual button at the bottom right of the Amp Connection section. The Lock virtual button will turn red to indicate the amplifier front panel has been locked.
3. Clear the 4-character code from the Lock Code window if you desire extra security.

Unlocking the amplifier

1. Type the amplifier's 4-character lock code into the Lock Code window near the bottom of the Amp Connection section.
2. Click on the Unlock virtual button located directly to the right of the Lock Code text box. The Unlock virtual button will light up blue to indicate the amplifier is unlocked, while the Lock button will change colors from red to gray. The characters in the Lock Code text box will disappear and be replaced by asterisks.

5.3.2 Configuration

The Configuration tab displays two main sets of software controls:

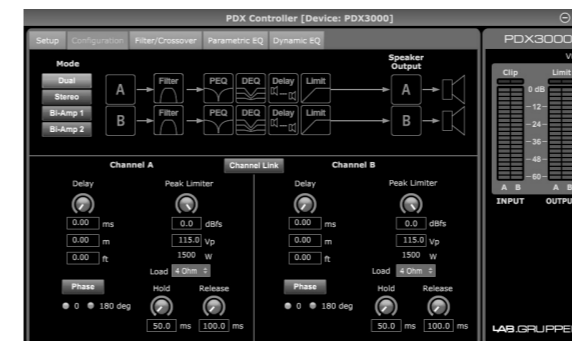

- **Mode**—controls the amplifier configuration. Choose between Dual Mono, Stereo, Bi-Amp 1, and Bi-Amp2 configurations. Each configuration's complete signal path appears in the display window, including the arrangement of internal DSP modules and speaker outputs.
- **Delay/Peak Limiter**—controls settings for the Delay and Limit DSP modules, as well as options for channel phase, Load settings (in Ohms) for the limiter wattage display, Hold and Release for the Limiter, and channel linking. The number of Delay/Peak Limiter controls change depending on the amplifier Mode configuration.

Mode

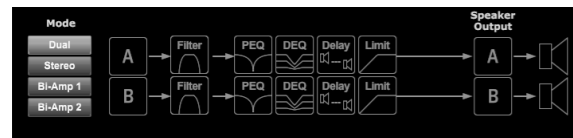

Changing amplifier mode

The amplifier mode can be changed by clicking on the button for your desired routing option along the left-hand side of the window. When you click on a mode button, the software will launch a confirmation window. Click “Yes” in the confirmation window to launch the new amplifier mode, and the new signal path will appear in the display.

Mode descriptions

Dual Mono

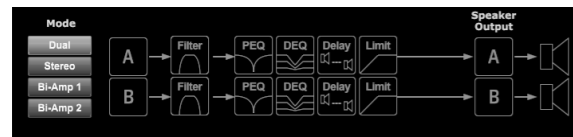

Dual Mono mode routes each channel input, A and B, through completely separate parallel signal paths with independent outputs for each channel. Each channel may be processed with its own unique filter, equalization, delay, and limiter settings. The Delay and Limit modules for A and B can be linked and programmed with identical settings by clicking on the Channel Link button below the Mode window.

Stereo

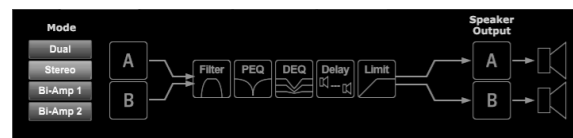

Stereo mode routes the signal from both the A and B inputs through a single series of DSP modules. Each DSP module processes both the A and B signals with identical, linked settings. The linked Delay and Limit parameters can be controlled from Stereo mode’s consolidated Channel A+B control window (which displays automatically when Stereo mode is selected).

Bi-Amp 1

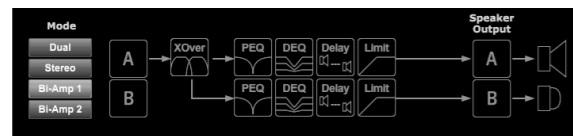

Bi-Amp 1 mode splits the Channel A input signal in the XOver DSP module at a programmable frequency point, and then routes the resulting high and low frequency signals through a parallel chain of DSP modules with independent equalization, delay, and limiter settings. The Delay and Limit modules for the split high and low frequency signals can be linked and programmed with identical settings by clicking on the Channel Link button below the Mode window. In Bi-Amp 1 mode, Output A routes low frequencies to a low-range speaker, while Output B connects to a high-frequency transducer.

Bi-Amp 2

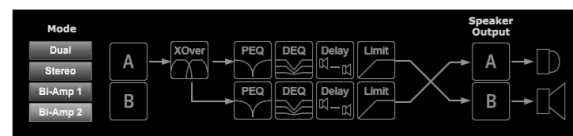

Bi-Amp 2 mode operates identically to Bi-Amp 1 mode, except that the signals are swapped between Outputs A and B (i.e., Output B handles low frequencies while Output A handles high frequencies). The swapped A and B output routing allows the user to quickly correct reversed high/low speaker connections without having to physically access the amplifier’s back panel and manually change the speaker connection.

Delay/Peak Limiter



Channel Link

In Dual Mono, Bi-Amp 1, and Bi-Amp 2 modes, the Channel Link virtual button will appear just above the Delay and Peak Limiter controls. When you click on the Channel Link virtual button, the button will light up, and the Delay and Peak Limiter controls for both channels will display identical values.

Delay

The Delay function digitally slows the final signal output from the amplifier by a programmable amount (expressed as either distance or time). This signal delay helps prevent phase and synchronization problems caused by sound traveling through air over long distances, e.g., between speaker arrays separated by long distances or between a performance stage and distant sound reinforcement speakers.

The Delay controls also simultaneously display the amount of signal delay in milliseconds (ms), meters (m), and feet (ft), which can be useful if you already know the precise distance between speakers.

Programming signal delay

1. Program the signal delay by using either of these two methods:
 - a) Rotate the Delay virtual knob clockwise until you achieve a suitable amount of signal delay. The ms, m, and ft text boxes will each display equivalent values as you rotate the virtual knob.
 - b) Type a delay value directly into one of the text boxes below the Delay virtual knob (ms, m, or ft, depending on your preference). The Delay virtual knob will rotate to a position matching the delay value you have entered.
2. Choose between 0° and 180° phase either by clicking on the Phase virtual button or by clicking directly on 0° or 180° directly below the virtual button. When the Phase virtual button is engaged, the virtual button will light blue and the indicator next to 180° will light up.

Peak Limiter

The Peak Limiter helps protect your speakers by preventing signal spikes at the amplifier’s output stage.

The Peak Limiter controls include a dedicated virtual knob with matching numerical displays in dBFS (decibels relative to full scale), Vp (Voltage(peak)), as well as a rating in Watts, which appears only when you choose an Ohm setting from the Load pulldown menu.

The PDX Controller software also allows you to see the amplifier’s total output as a rating in Watts. This Watt rating allows you to connect speakers with lower power ratings and then adjust the limiter to match the speakers’ maximum Watt rating.

Note: the PDX Controller software does not automatically detect or show the total speaker load connected to the amplifier.

Controls for Hold and Release times appear near the bottom of the window, each with a matching numerical display.

Programming the output limiter

1. Program the output limiter by using either of these two methods:
 - a) Rotate the Peak Limiter virtual knob counter-clockwise until you find an adequate limiter setting for your sound system. The dBFS (decibels relative to full scale) and Vp (Voltage [peak]) text boxes will each display equivalent values as you rotate the virtual knob.
 - b) Type a limiter value directly into one of the text boxes below the Peak Limiter virtual knob (dBFS or Vp). The Peak Limiter virtual knob will rotate to a position matching the delay value you have entered.
2. Choose a Load value from the Load pulldown menu (none, 2, 4, 8, or 16 Ohms) that matches the total combined load of all speakers connected to the amplifier’s outputs. If your combined speaker load in Ohms does not exactly match 2, 4, 8, or 16 Ohms, choose the next lower Ohm setting from the Load pulldown menu. When you select a Load setting, an additional Watt rating for the limiter will appear above the Load pulldown menu.
3. Choose a Hold value either by rotating the Hold virtual knob or by entering a value (in milliseconds) into the matching text box below the knob.
4. Choose a Release value either by rotating the Release virtual knob or by entering a value (in milliseconds) into the matching text box below the knob.

5.3.3 Filter/Crossover

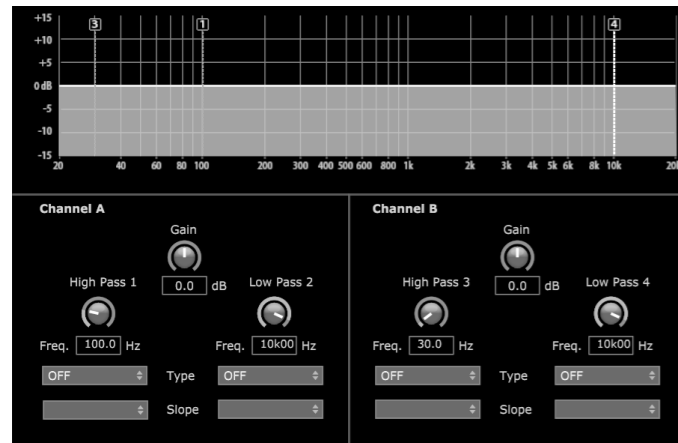

The Filter/Crossover tab displays and controls Filter/XOver module settings in two formats:

- **Frequency Curve**—displays the filter curves in visual form, and allows click-and-drag manipulation of filter threshold points.
- **Control View**—allows parameter tweaks via virtual controls, as well as pull-down menus for filter type and slope.

The Frequency Curve and Control View interact with each other and simultaneously shift as you change parameters in either view.

Filter/Crossover Frequency Curve Display

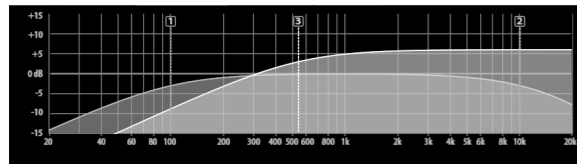

The Frequency Curve displays a frequency range from 20 Hz to 20 kHz, with 15 dB of cut/boost displayed on the vertical axis. Within this graphic field, the filter curve appears as a solid, colored line running from left to right. The line shifts and moves to reflect changing parameter values entered using the virtual controls and pull-down menus. Dotted vertical lines indicate frequency threshold points for the various filters, numbered 1 through 4, and these threshold points can be selected and moved through the frequency spectrum using the mouse or trackpad.

Moving filter thresholds via click-and-drag

1. Click and hold on the numbered box at the top of the desired filter threshold line.
2. Drag the threshold line to the desired location on the frequency spectrum.
3. The filter curve shown by the solid line will move and adjust as you shift the threshold line. The virtual knob and frequency displayed in the Control View will also simultaneously change as you move the threshold line in the Frequency Curve.

Filter/Crossover Control View

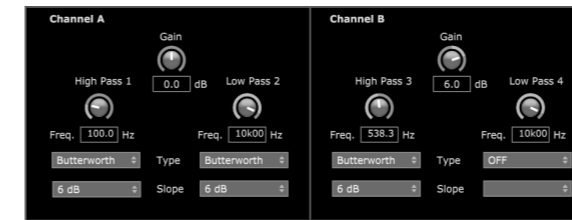

The Control View of the Filter/Crossover tab contains virtual knob controls for Gain, High Pass filter, and Low Pass filter. Exact parameter values appear in boxes below each virtual knob. These parameters may be altered by either adjusting the virtual knobs or by entering values directly in the parameter boxes.

Pull-down menus contain filter options for Type (Butterworth, Bessel, Linkwitz-Riley) and Slope (6–48 dB/Octave).

X-Over option for bi-amping

In Bi-Amp 1 and Bi-Amp 2 modes, the X-Over button appears on the Filter/Crossover tab. Activating the X-Over button links the Low Pass 2 and High Pass 3 filter controls and automatically creates a synchronized crossover point for bi-amped low frequency and high frequency signals.

Setting a linked crossover frequency

1. Activate the Bi-Amp 1 or Bi-Amp 2 settings on the Configuration tab.
2. Click on the Filter/Crossover tab.
3. Click on the X-Over button on the Filter/Crossover tab. The X-Over button will light up and overlapping filter curves will appear in the Frequency Curve.
4. Set the crossover frequency by any of these methods:
 - a) drag the Low Pass 2/High Pass 3 threshold line to the desired frequency in the Frequency Curve by clicking and dragging;
 - b) adjust the Low Pass 2 or High Pass 3 virtual knobs;
 - c) Enter the desired frequency directly into the Freq. text box.
5. Select a filter curve from the Type dropdown menu below either the Low Pass 2 or High Pass 3 virtual knobs.
6. Select the desired curve steepness from the Slope dropdown menu.

5.3.4 Parametric EQ

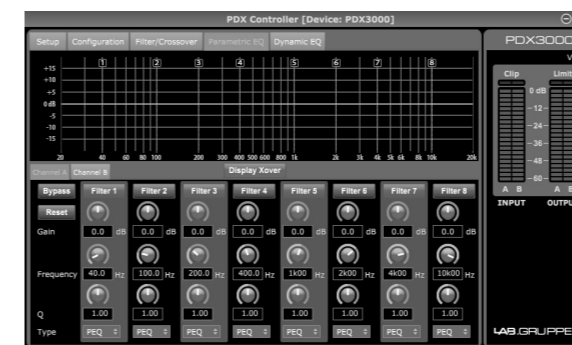

The Parametric EQ tab displays and controls PEQ DSP module settings in two formats (similar to the Filter/Crossover tab):

- **Control View**—allows parameter tweaks via virtual controls, as well as pull-down menus for EQ type (parametric, low shelving, and high shelving).
- **Frequency Curve**—displays the filter curves in visual form, and allows click-and-drag manipulation of EQ frequencies and gain.

The Frequency Curve and Control View interact with each other and simultaneously shift as you change parameters in either view.

Parametric EQ Control View

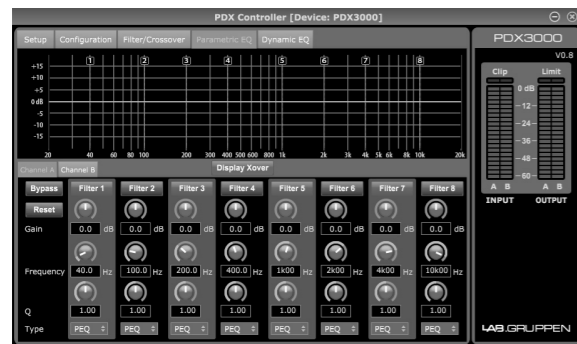

The Control View of the Parametric EQ tab contains virtual knob controls for Gain, Frequency, Q (parametric EQ only). Exact parameter values appear in boxes below each virtual knob. These parameters may be altered by either adjusting the virtual knobs or by entering values directly in the parameter boxes.

To activate an EQ band, click the button (Filter 1, Filter 2, and so on) at the top of each channel strip. The channel button will light up to indicate the EQ is active.

Pull-down Type menus for each EQ band contain these additional options:

- PEQ (parametric EQ)
- LS6 (low shelving EQ, with a 6 dB/Octave slope)
- LS12 (low shelving EQ, with a 12 dB/Octave slope)
- HS6 (high shelving EQ, with a 6 dB/Octave slope)
- HS12 (high shelving EQ, with a 12 dB/Octave slope)

Parametric EQ Frequency Curve Display

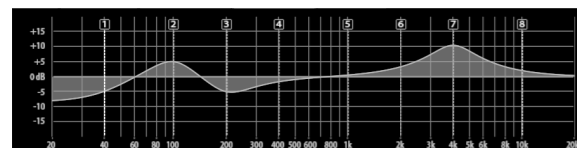

The Frequency Curve displays a frequency range from 20 Hz to 20 kHz, with 15 dB of cut/boost displayed on the vertical axis. Within this graphic field, the EQ curve appears as a solid fill above and below the 0 dB center line and running from left to right. The curve shifts and moves to reflect changing parameter values.

Dotted vertical lines indicate frequency points for the various EQ bands, numbered 1 through 8, and these frequency points can be selected and moved through the frequency spectrum using the mouse or trackpad. The gain for each dynamic EQ band may also be adjusted by using the frequency lines.

Adjusting Parametric EQ frequency via click-and-drag

1. Click and hold on the numbered box at the top of the desired EQ band frequency line.
2. Drag the frequency line to the desired location on the frequency spectrum.
3. The EQ curve shown by the solid blue fill will move and adjust as you shift the frequency line. The virtual knob and frequency displayed in the Control View will also simultaneously change as you move the frequency line in the Frequency Curve.

Adjusting Parametric EQ gain via click-and-drag

1. Click and hold over the numbered box at the top of the desired EQ band's frequency line.
2. Move the cursor vertically up or down the frequency line to the desired gain level.
3. The EQ curve shown by the solid blue fill will re-size and adjust as you move the cursor up and down the frequency line. The virtual gain knob and gain dB displayed in the Control View will also simultaneously change as you move the cursor up and down frequency line in the Frequency Curve.

5.3.5 Dynamic EQ

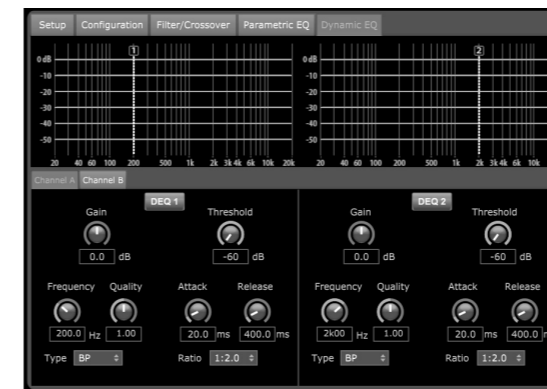

The Dynamic EQ tab displays and controls DEQ DSP module settings in two formats (similar to the Filter/Crossover and Parametric EQ tabs):

- **Frequency Curve**—displays the layered dynamic EQ curves in visual form, and allows click-and-drag manipulation of dynamic EQ/filter frequencies and gain.
- **Control View**—allows parameter tweaks via virtual controls, as well as pull-down menus for EQ/filter type (Type) and gain reduction/boost ratio (Ratio).

The Frequency Curve and Control View interact with each other and simultaneously shift as you change parameters in either view.

Dynamic EQ Frequency Curve Display

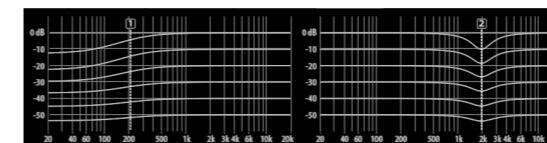

The Frequency Curve displays a frequency range from 20 Hz to 20 kHz, with layered dynamic EQ curves. Within this graphic field, the dynamic EQ curves appear as solid blue lines that appear at every 10 dB (0 to -50 dB) threshold on the vertical axis. The curves shift and move to reflect changing parameter values. Dotted vertical lines indicate frequency points for the various dynamic EQ bands, numbered 1 and 2 (per channel), and these frequency points can be selected and moved through the frequency spectrum using the cursor. The gain for each dynamic EQ band may also be adjusted by using the frequency lines.

Adjusting dynamic EQ frequency via click-and-drag

1. Click and hold on the numbered box at the top of the desired dynamic EQ band frequency line.
2. Drag the frequency line to the desired location on the frequency spectrum.
3. The layered dynamic EQ curves shown by the layered blue lines will move and adjust as you shift the frequency line. The virtual knob and frequency displayed in the Control View will also simultaneously change as you move the frequency line in the Frequency Curve.

Adjusting dynamic EQ gain via click-and-drag

1. Click and hold on the numbered box at the top of the desired dynamic EQ band frequency line.
2. Move the cursor vertically up or down the frequency line to the desired gain level.
3. The layered EQ curves shown by the solid blue line will adjust as you move the cursor up and down the frequency line. The virtual gain knob and gain dB displayed in the Control View will also simultaneously change as you move the cursor up and down frequency line in the Frequency Curve.

Dynamic EQ Control View

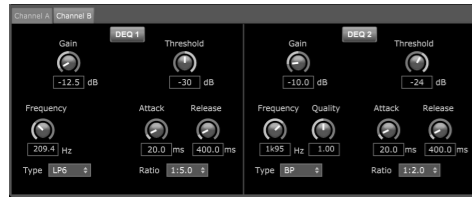

The Control View of the Dynamic EQ tab contains virtual knob controls for Gain, Threshold, Frequency, Q (bandpass filter only). Exact parameter values appear in boxes below each virtual knob. These parameters may be altered by either adjusting the virtual knobs or by entering values directly in the parameter boxes.

Pull-down Type menus for each dynamic EQ band contain these additional options:

- BP (bandpass filter)
- LP6 (lo-pass filter, with a 6 dB/Octave slope)
- LP12 (lo-pass filter, with a 12 dB/Octave slope)
- HP6 (hi-pass filter, with a 6 dB/Octave slope)
- HP12 (hi-pass filter, with a 12 dB/Octave slope)

The Ratio pull-down menu offers four options:

- 1:2.0
- 1:3.0
- 1:5.0
- 1:10

Gain vs. Ratio

Positive gain settings result in a frequency boost at low signal levels and a nearly flat EQ response at high levels. Negative gain settings yield opposite results: at low signal levels, the EQ response is nearly flat, while higher signal levels receive increasing amounts of cut from the equalizer. The higher the Ratio setting, the more the equalizer will cut or boost the signal at different signal levels.

Programming a dynamic EQ

1. Choose an EQ type from the Type pull-down menu.
2. Set the dynamic EQ's band frequency by rotating the Frequency virtual knob. The programmed frequency can represent either the center frequency for band-pass (BP) mode, or the threshold frequency for low- (LP) and high-pass modes (HP).
3. For band-pass BP mode, control the width of the band-pass curve by rotating the Quality virtual knob parameter. High Qual values produce a narrow, steep curve, while low Qual values create a wide curve with a gentle slope.
4. Set the dynamic EQ's band cut or boost by rotating the Gain virtual knob.
5. Set the signal threshold by rotating the Threshold knob.
6. Program your desired ratio by selecting from the Ratio pull-down menu. Similar to a compressor, higher ratio values yield a more intense equalization effect.
7. Adjust the attack (Attack) and release (Release) values by rotating each parameters respective virtual knob.

6. Applications

Refer to the application documentation available for download at labgruppen.com.

6.1 Bi-amping

Bi-amping splits a mono signal into upper and lower frequency bands, and then assigns each frequency band to separate speaker cabinets or separate drivers within a cabinet. A subwoofer typically takes the low frequency range. By splitting the signal this way, the speakers work more efficiently, and you can achieve a cleaner overall sound.

Setting up hardware for bi-amping

1. Run a 4-pole speaker cable with professional twist-locking connectors from OUTPUT CH A to the subwoofer (the subwoofer receives its low-frequency signal from Channel B using poles 2+ and 2-, while the middle and upper frequency ranges use Channel A via poles 1+ and 1-).
2. Set the subwoofer into BIAMPING mode.
3. Run a 2-pole speaker cable with professional twist-locking connectors from the subwoofer to the other speaker.

Programming DSP parameters for bi-amping using the front panel

1. Choose the BIAMP2 setting on the Amp Mode screen.
2. Go to the XOVER screen using the UP/DOWN buttons to set appropriate high/low crossover frequencies.
3. In Channel A#1, choose your high-pass filter type (HPtype: BUT6, BUT12, BES12, etc.) and set the cutoff frequency (HPfreq) to approximately 100 Hz. Deactivate the low-pass filter (LPtype: OFF) on this channel and set the gain level (Gain) to suit your system.
4. In Channel B#1, choose your low-pass filter type (LPtype: BUT6, BUT12, BES12, etc.) and set the cutoff frequency (LPfreq) to approximately 100 Hz. Deactivate the high-pass filter (HPtype: OFF) on this channel and set the gain level (Gain) to suit your system.

Programming PDX Controller Software for bi-amping

1. Select the Configuration tab.
2. Choose the BIAMP2 signal path in the Configuration tab. A confirmation window will pop up.
3. Click "Yes" on the Amp Mode confirmation window.
4. Select the Filter/Crossover tab.
5. Select the X-Over button below the Frequency Curve display. A confirmation window will pop up asking if you wish to set a Default Crossover.
6. Click "Yes" in the confirmation window. The X-Over button will illuminate, and default crossover settings will appear in the Frequency Curve and Control View.
7. Choose a filter type from either the Low Pass 2 or High Pass 3 Type pull-down menus (the software defaults to a Butterworth filter). Any changes to the Low Pass 2 or High Pass 3 settings will also automatically appear in both filter's Control View settings.
8. Choose a filter slope setting from the Slope pull-down menu under either Low Pass 2 or High Pass 3 (the software defaults to a Butterworth filter). Again, matching parameters will automatically appear in both filter's Control View settings.
9. Set the crossover frequency by using any of these three methods:
 - a) Rotate the Low Pass 2 or High Pass 3 virtual Freq knobs in the Control View. The crossover frequency displayed in the Freq box below the virtual knob will change simultaneously for both filters.
 - b) Select the text box below either Freq virtual knob, and type your desired frequency directly into the text box.
 - c) Go to the Frequency Curve display, click on the frequency line marked "2," and drag the frequency line to the desired area of the Frequency Curve. Parameter settings and virtual knobs in the Control View will automatically move and change as you drag the crossover frequency through the Frequency Curve window.
10. If necessary, adjust the Gain settings for Channel A and Channel B by rotating the respective Gain virtual knobs.

6.2 Hookup Diagrams

One side sub and linked passive top, Turbosound NuQ102 and NuQ118B together with Lab.gruppen PDX3000

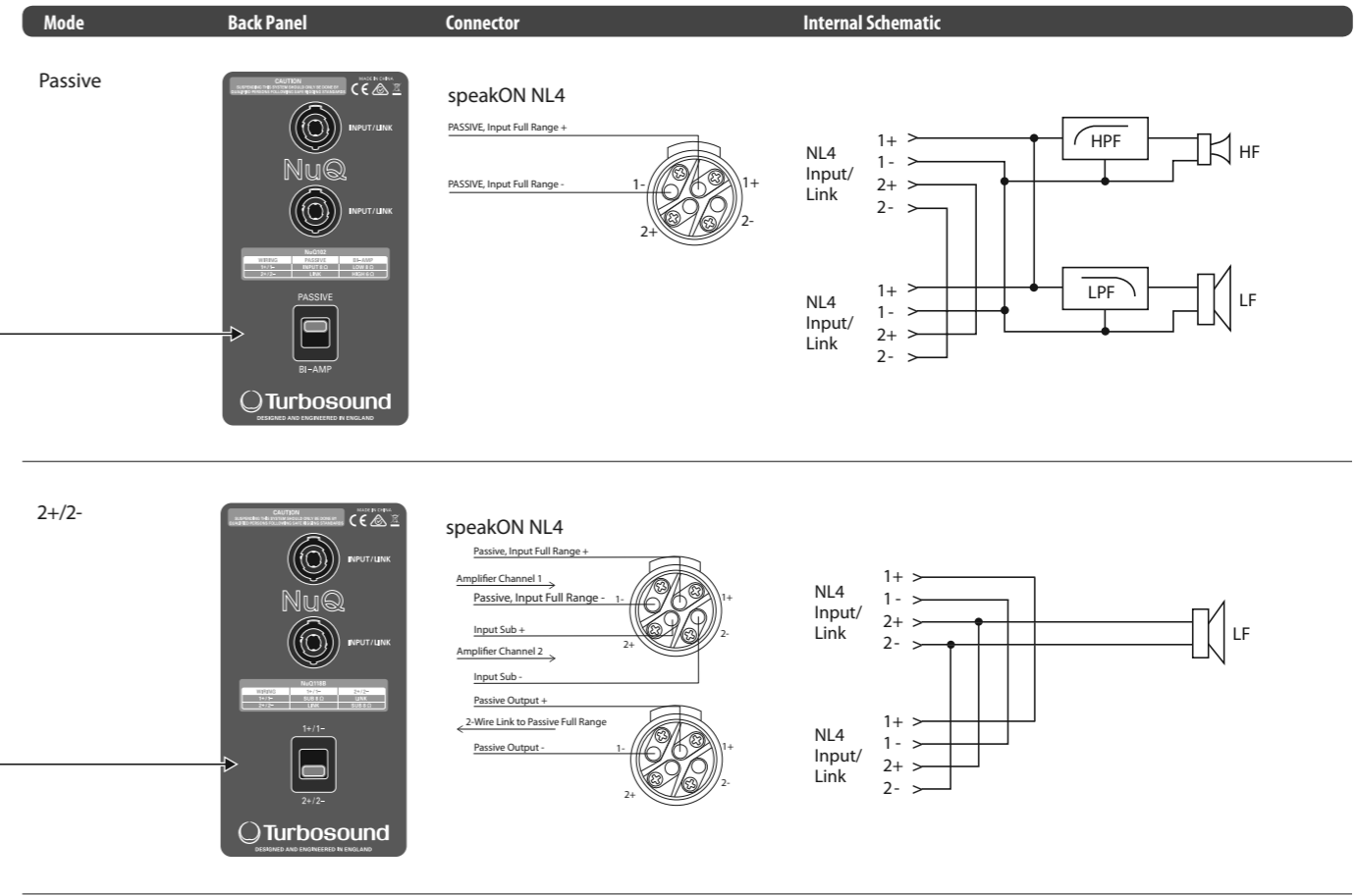
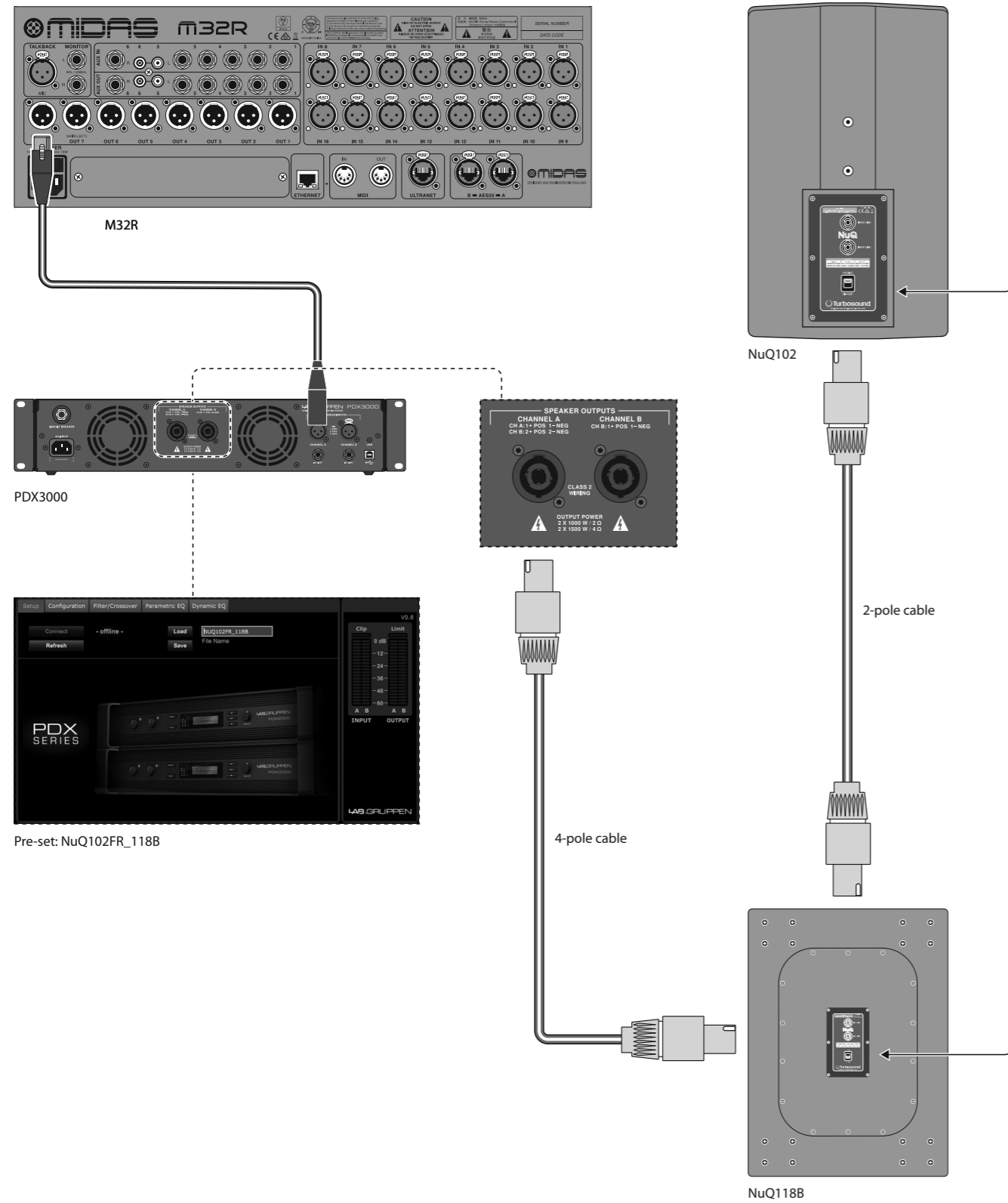

Two passive fullrange tops in stereo, Turbosound NuQ102 together with Lab.gruppen PDX3000

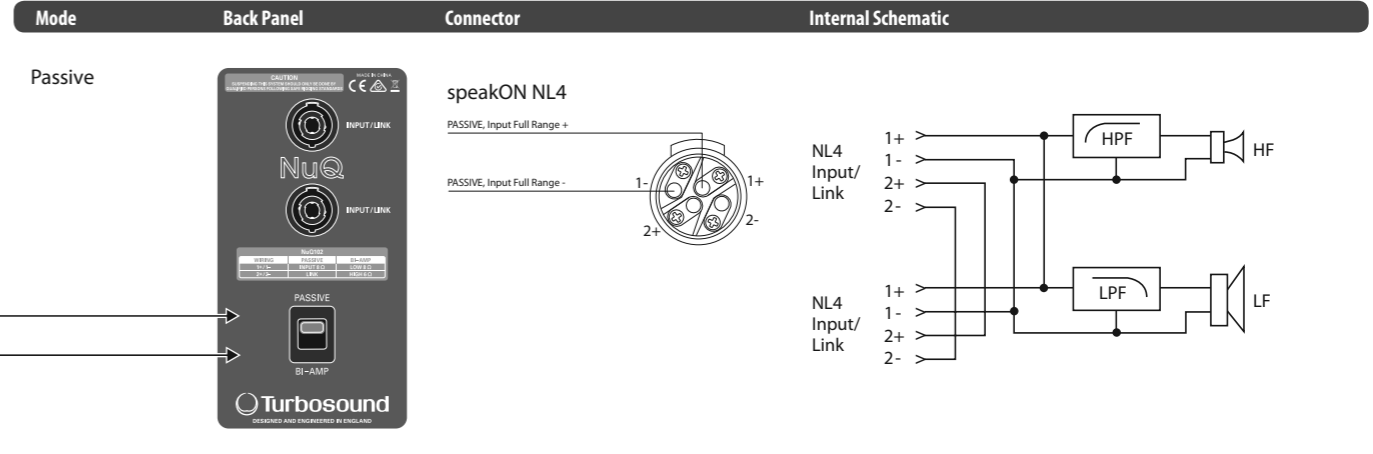
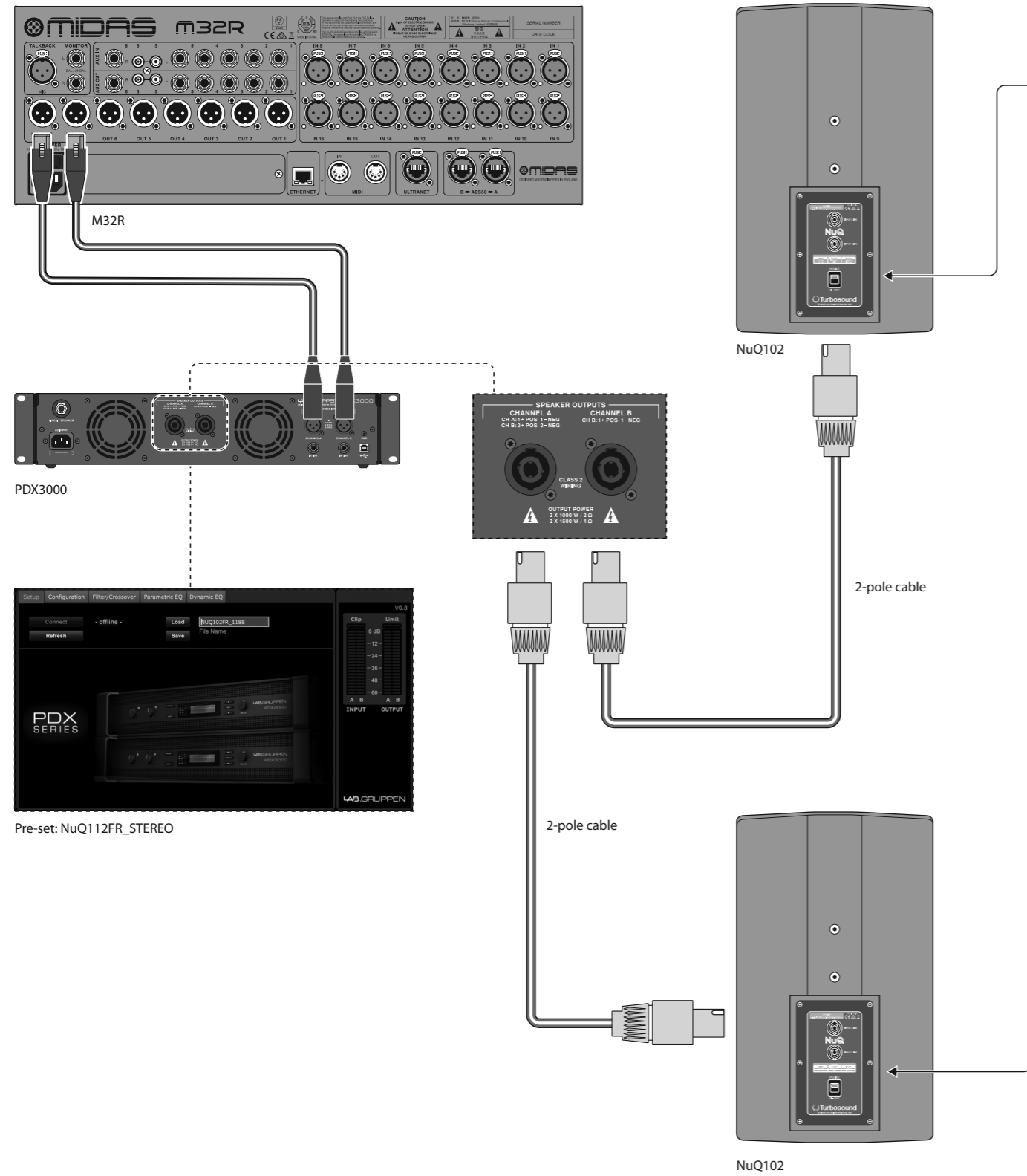

Fullrange monitor in bi-amp mode, Turbosound TFM122M together with Lab.gruppen PDX3000

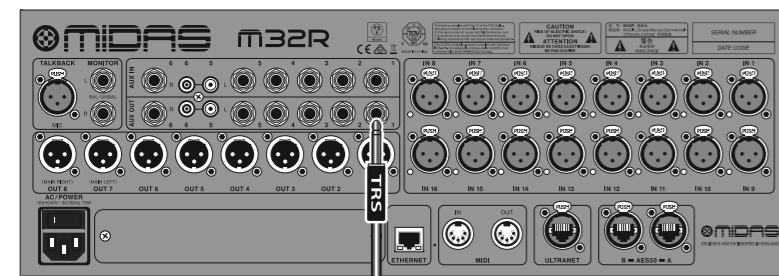

M32R

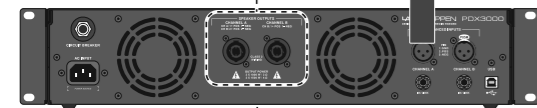

PDX3000

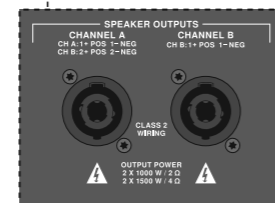

Pre-set: TFM112M_BI AMP

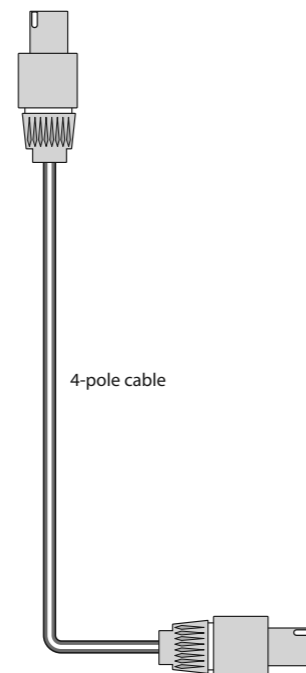

TFM122M

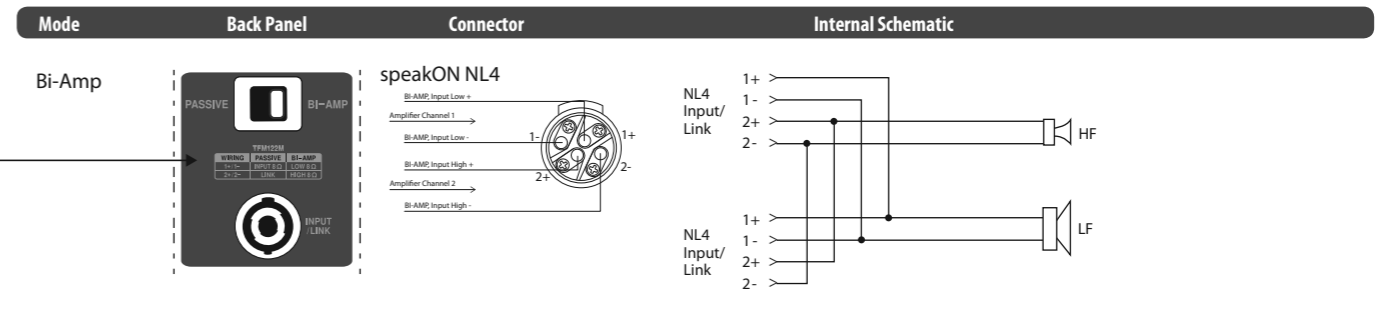

Two passive fullrange monitors, two Turbosound TFM122M together with Lab.gruppen PDX3000

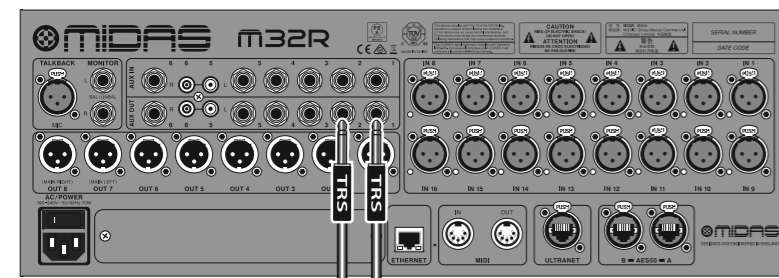

M32R

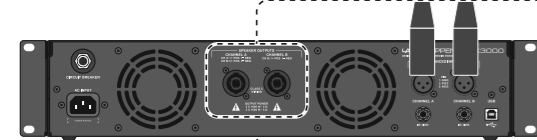

PDX3000

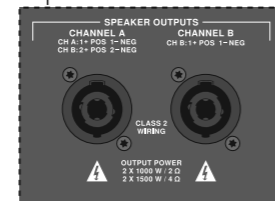

Pre-set: TFM112M_DUAL MONO

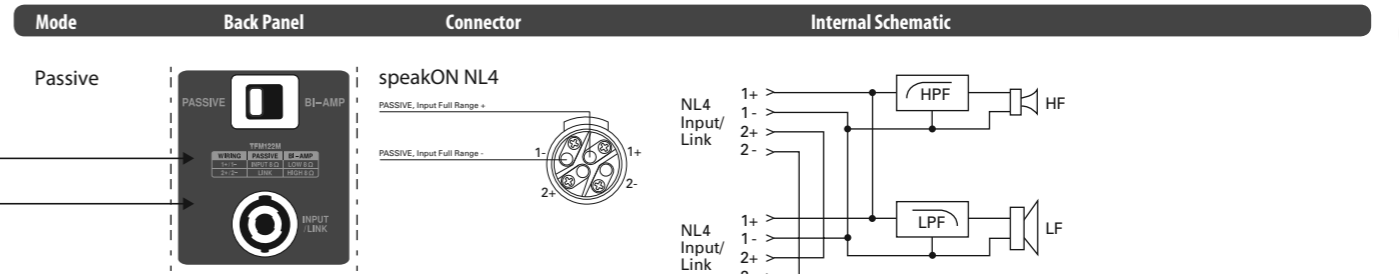
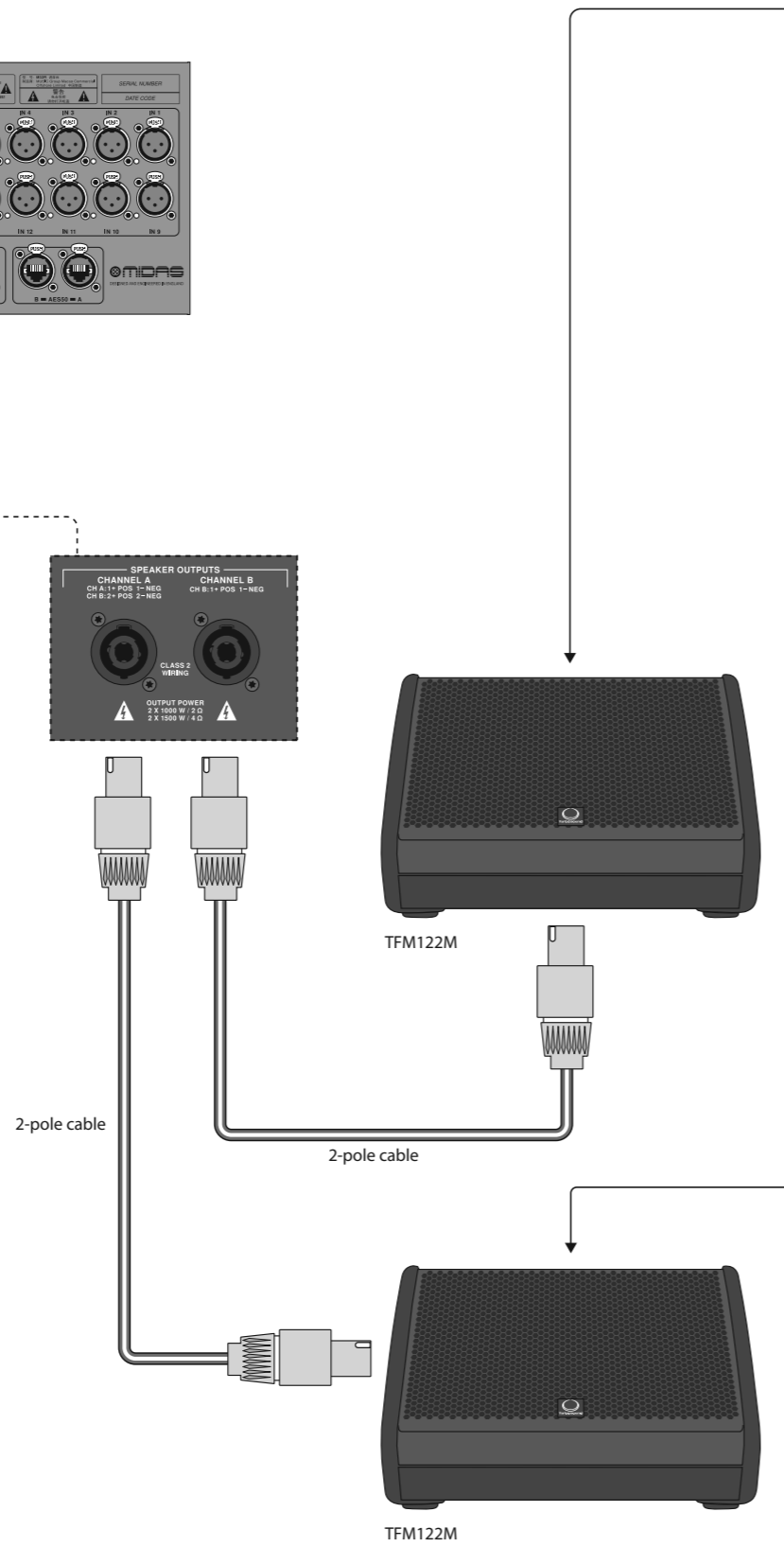

EN

Two tops in bi-amp mode, two subs in passive mode, two Turbosound NuQ152 and NuQ118B together with three Lab.gruppen PDX3000

EN

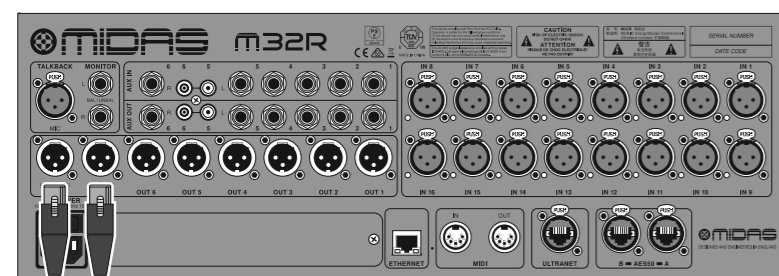

M32R



Pre-set: NuQ118B_DUAL MONO

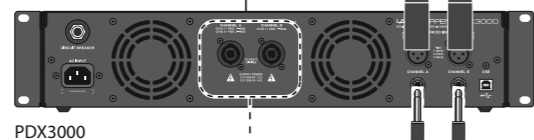

PDX3000

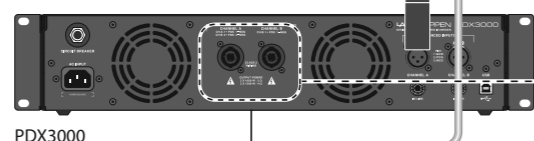

PDX3000

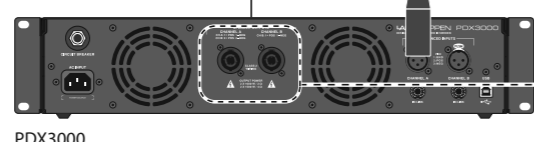

PDX3000



Pre-set: NuQ152_BI AMP

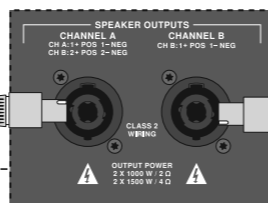
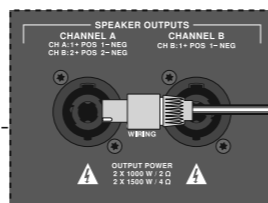
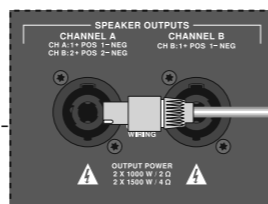

NuQ152

4-pole cable

4-pole cable

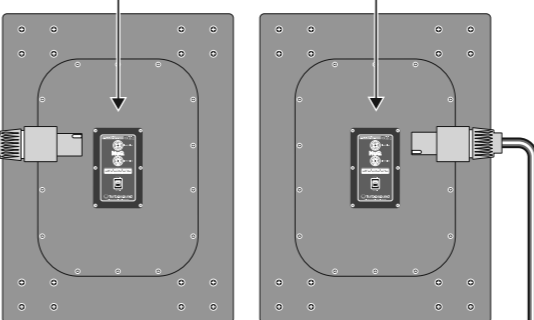

NuQ118B

2-pole cable

Bi-Amp

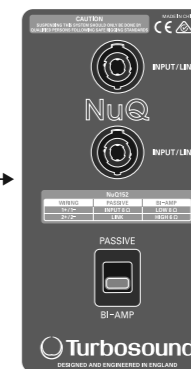

speakON NL4

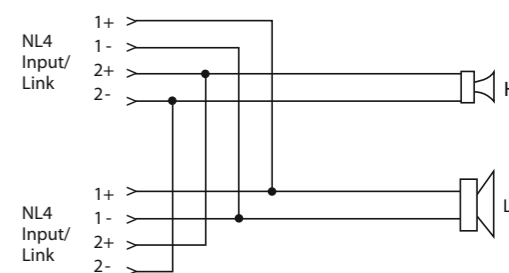
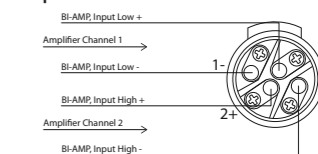

4-Wire Single Cable Run Operation 1+/1-

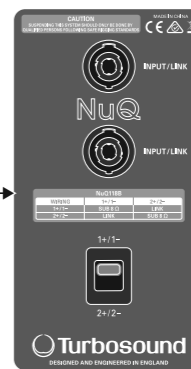

speakON NL4

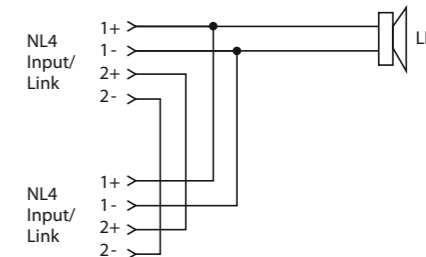
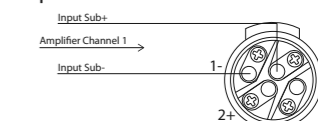

Warning! Connecting a full-range speaker switched to bi-amp while using a 4-pole cable may cause damage to the compression driver. The full-range speaker must be switched to passive mode. Using 2-pole cables between the subwoofer and full-range speaker is recommended.

7. Installation

7.1 Rack mounting

Your PDX amplifier fits into a 19" rack and requires two rack units. Install into the rack using four attaching screws and washers for the front panel. Consider reinforcing the back panel using rack accessories (supplied with rack), especially if you will be taking the PDX on the road. Make sure enough cool air reaches the rack, especially when other rack equipment emanates a lot of heat. The PDX amplifiers circulate heat from the front to the rear vents to relieve heat inside the rack enclosure.

If you are installing multiple power amplifiers into a 19" rack, add filled panels in the empty rack spaces to avoid circulation of hot air.

Fan speed adjusts automatically to assure safe operation. Never block ventilation openings. Should internal temperature reach extreme values, the unit will shut down automatically, and resume operation when cooled down.

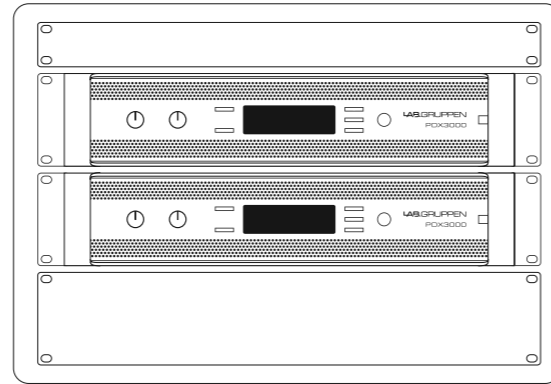

7.2 Connections

Audio inputs

Each channel input uses either XLR or 1/4" jacks. The XLR jacks can accept balanced XLR connections, while the 1/4" jacks can accept both balanced 1/4" TRS connectors and unbalanced 1/4" TS connectors. To deploy XLR connectors for unbalanced signals, bridge pins 1 and 3; mono 1/4" TS connectors do not require any alteration to carry unbalanced signals.

When working with balanced signals, please make sure to exclusively use balanced cables. One unbalanced cable in the signal chain can change a balanced signal into an unbalanced signal.

Outputs

Your PDX amplifier requires speakON twist-locking professional speaker connectors. These professional speaker connectors were developed specially for driving high-powered speakers. The connectors snap in securely, prevent electric shock, and ensure correct polarity.

The CHANNEL A output contains output pins for both CHANNEL A (1+/1-) and CHANNEL B (2+/2-), so that both channels, if desired, can be sent out simultaneously on a single 4-pole speaker cable.

The CHANNEL B output, on the other hand, has pin outs for CHANNEL B only (1+/1-).

Balanced use with XLR connectors



input

- 1 = ground/shield
- 2 = hot (+ve)
- 3 = cold (-ve)

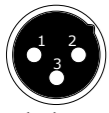

output

For unbalanced use, pin 1 and pin 3 have to be bridged

Unbalanced 1/4" TS connector

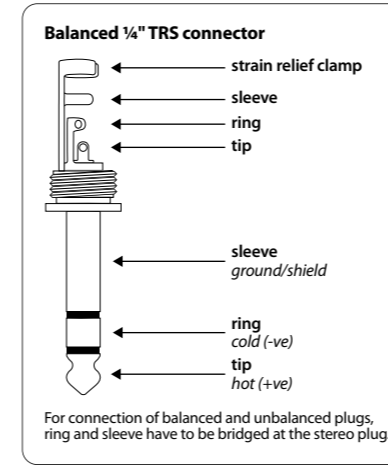
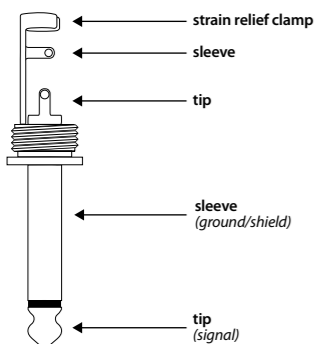

◆ Whenever possible, use thick and short speaker cables to minimize power loss.

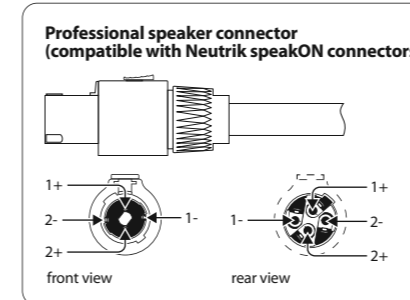

Maximum recommended cable length for

Cable Size		2 ohm		4 ohm		8 ohm	
AWG	mm ²	meter	feet	meter	feet	meter	feet
12	2.0	9	30	18	60	36	120
10	2.6	15	50	30	100	60	150

7.3 Connecting to mains

Always connect your PDX amplifier to the voltage specified on the rear of the device. Connecting the amp to an incorrect voltage can permanently damage your amp.

Before powering up the amplifier, double-check all connections and fully lower the gain setting.

8. Specifications

General	
Number of amplifier channels	2
Number of processing channels	2
Peak total output all channels driven	3000 W
Peak output voltage per channel	115 V
Peak output current per channel	32 A
Bridge mode	No
Output circuit type	Class-D
Amplifier Outputs	
Max Output Power	
All channels driven	
2 Ω per channel	1000 W
4 Ω per channel	1500 W
8 Ω per channel	800 W
Audio Performance	
THD+N 20 Hz - 20 kHz @ 1 W	< 0.1%
THD+N @ 1kHz, 1 dB below clip	< 0.1%
Signal-to-noise	>90 dB
Channel separation (Crosstalk) @ 1 kHz	>75 dB
Frequency response	10 Hz to 20 kHz, +0.5/ -1 dB
Input impedance	10 kΩ unbalanced, 20 kΩ balanced
Internal Sample rate	96 kHz
Product propagation delay	0.6 ms
Distortion, 1/8 rated power	< 0.1%
System	
Controls	
Front	Power switch Gain controls (channels A and B) DSP section rotary push-encoder Buttons for Process, Setup, Up/Down, Exit
Remote	Via USB for PDX Controller software running on computer
Indicators	
Display	LCD 128 x 32, White text on black background
Power	RDY LEDs lit green
Limit, per channel	LIM LEDs lit red
Signal, per channel	-24 dB, -12 dB, -6 dB LEDs lit green
Thermal Warning, per channel	RDY LED blink orange
Thermal Warning 90%, PSU	Both RDY LEDs blink orange
Thermal fault, per channel	RDY LED blink red
Thermal fault 100%, PSU	Both RDY LEDs blink red
Fault, channel	RDY LED lit constantly red
Fault, device	Both RDY LEDs constantly lit red

System	
Integrated DSP features	
Delay	0 – 300 ms
Crossover function	3 filter types, up to 48 dB/oct.
EQ function	8-band parametric, 2-band dynamic equalizer
Limiter	Zero attack limiter (peak)
Presets	20 total presets, 19 user-definable
Connectors	
Inputs / link	2 x XLR 2 x ¼" TRS
Outputs	Neutrik speakON (2 x NL4)
USB connector	Rear panel USB connector type B for remote control of DSP section with PDX Controller Software
Mains connector	Locking IEC appliance inlet, C14
Protection Features	
Cooling	Two fans front-to-rear air flow, temperature controller speed
Amplifier protection	Thermal and DC protection, Rail sensing and peak current limiting.
Load protection	Controlled start and shutdown behavior, DC-fault protection, Short-circuit protection
Power Supply	
Voltage	Separate 230 V and 115 V versions available. Not selectable on the product.
USA / Canada / Japan	100-120 V, 50/60 Hz
UK / Australia / Europe / Korea / China	220-240 V, 50/60 Hz
Power consumption @ 4 ohms, rated power	1050 W
Dimensions / Weight	
Dimensions (H x W x D)	93 x 483 x 326 mm (3.7 x 19 x 12.8")
Weight	6.5 kg (14.3 lbs)
Finish	Black painted aluminium chassis and grey front
Approvals	CE, UL (ANSI/UL, CAN/CSA), PSE, RCM, CCC, FCC

Other important information

EN Important information

1. Register online. Please register your new Music Tribe equipment right after you purchase it by visiting labgruppen.com. Registering your purchase using our simple online form helps us to process your repair claims more quickly and efficiently. Also, read the terms and conditions of our warranty, if applicable.

2. Malfunction. Should your Music Tribe Authorized Reseller not be located in your vicinity, you may contact the Music Tribe Authorized Fulfiller for your country listed under "Support" at labgruppen.com. Should your country not be listed, please check if your problem can be dealt with by our "Online Support" which may also be found under "Support" at labgruppen.com. Alternatively, please submit an online warranty claim at labgruppen.com BEFORE returning the product.

3. Power Connections. Before plugging the unit into a power socket, please make sure you are using the correct mains voltage for your particular model. Faulty fuses must be replaced with fuses of the same type and rating without exception.

FEDERAL COMMUNICATIONS COMMISSION COMPLIANCE INFORMATION

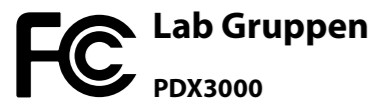

Responsible Party Name: **Music Tribe Commercial NV Inc.**

Address: **5270 Procyon Street
Las Vegas, NV 89118
USA**

Phone Number: **+1 702 800 8290**

PDX3000

complies with the FCC rules as mentioned in the following paragraph:

This equipment has been tested and found to comply with the limits for a Class B digital device, pursuant to part 15 of the FCC Rules. These limits are designed to provide reasonable protection against harmful interference in a residential installation. This equipment generates, uses and can radiate radio frequency energy and, if not installed and used in accordance with the instructions, may cause harmful interference to radio communications. However, there is no guarantee that interference will not occur in a particular installation. If this equipment does cause harmful interference to radio or television reception, which can be determined by turning the equipment off and on, the user is encouraged to try to correct the interference by one or more of the following measures:

- Reorient or relocate the receiving antenna
- Increase the separation between the equipment and receiver
- Connect the equipment into an outlet on a circuit different from that to which the receiver is connected
- Consult the dealer or an experienced radio/TV technician for help

This device complies with Part 15 of the FCC rules. Operation is subject to the following two conditions:

- (1) this device may not cause harmful interference, and
- (2) this device must accept any interference received, including interference that may cause undesired operation.

Important information:

Changes or modifications to the equipment not expressly approved by Music Tribe can void the user's authority to use the equipment.

