



**MXC**

Microflex<sup>®</sup> Complete

User guide for the Shure Microflex Complete audio conferencing system.  
Version: 2 (2019-I)

# Table of Contents

<b>MXCMicroflex® Complete</b>	<b>4</b>	Dual Delegate Role	24
<b>Important Safeguards</b>	<b>4</b>	User Indications	25
Labels	5	<b>Web Interface</b>	<b>25</b>
Note for Power Connections	5	Open the CCU Web Interface	26
Power Disconnect	6	Assigning the Network Address	27
Warning:	6	Additional Screens	27
<b>Overview</b>	<b>6</b>	Language Setting	30
<b>Information in This Manual</b>	<b>6</b>	<b>User Interface for the MXC640</b>	<b>31</b>
<b>Features</b>	<b>6</b>	Navigation Pane	32
Feature Licenses	7	Home Screen	33
<b>DIS-CCU Central Control Unit</b>	<b>9</b>	Agenda	34
Simplified Audio Diagram	10	Voting/Result Menu	35
CCU Hardware Description	10	Results	35
Menu Navigation	11	Channel Selector	36
<b>MXC Conference Units</b>	<b>13</b>	Voting Functionality	37
Conference Unit Hardware Descriptions	13	<b>Audio Settings</b>	<b>37</b>
Portable Model Variations	14	Microphone Functionality	37
Flush-Mounted Model Variations	16	Route Microphones to Groups	38
NFC Card functionality	18	Floor Mix on the Loudspeakers	39
<b>Microflex Multipin Gooseneck Microphones</b>	<b>18</b>	Headphone Channels	39
Snap-Fit Windscreen	19	Analog Audio Outputs	40
<b>Connecting Conference Units and DCS-LAN Components</b>	<b>20</b>	Adding an External Audio Source	40
Connection Diagrams	21	<b>Meeting Configuration</b>	<b>41</b>
Basic Setup with Conference Units	21	Names, Roles and Seat Numbers	42
<b>Controlling the Conference Unit</b>	<b>23</b>	Meeting Controls	43
Chairman Role	24	Voice Detection	47
Delegate Role	24	<b>Security</b>	<b>48</b>
		Password Protect the Browser Interface	49
		<b>Language Interpretation</b>	<b>49</b>
		Interpretation Setup	50

---

Interpretation Settings	50	PS-CCU Power Supply	63
Wireless Language Distribution	51	Optional Accessories and Replacement Parts	63
Listening to Interpretation	52	<b>Technical Specifications</b>	<b>64</b>
<b>Firmware Update</b>	<b>52</b>	Microflex Complete System	64
<b>Rackmounting the CCU</b>	<b>52</b>	Wiring Details	64
Installing the Conference Units	53	Common System Specifications	66
Connecting DCS-LAN Equipment	54	Conference Unit Specifications	67
Installing Large Systems	57	Audio Specifications	72
<b>Troubleshooting</b>	<b>58</b>	<b>Cleaning</b>	<b>74</b>
Diagnostics	59	Repacking	74
<b>Backup, Restore, Factory Reset</b>	<b>61</b>	Warranty	74
<b>Devices and Accessories</b>	<b>61</b>	Important Product Information	74
Model Variations	62	<b>Certifications</b>	<b>75</b>

# MXC Microflex<sup>®</sup> Complete

## Important Safeguards

1. **Read these instructions** - All the safety and operating instructions should be read before the apparatus or system is operated.
2. **Keep these instructions** - The important safety instructions and operating instructions should be retained for future reference.
3. **Follow all warnings** - All warnings on the apparatus and in the operating instructions should be adhered to.
4. **Follow all instructions** - All instructions for installation or use/operating should be followed.
5. **Do not use this apparatus near water** - Do not use this apparatus in a water or moistures environment - for example, near a bath tub, wash bowl, kitchen sink, or laundry tub, in a wet basement, near a swimming pool, in an unprotected outdoor installation, or any area which is classified as a wet location.
6. **Warning: To reduce the risk of fire or electric shock, do not expose this apparatus to rain or moisture and no objects filled with liquids, such as vases, should be placed on this apparatus.**
7. **Clean only with dry cloth** - Unplug the apparatus from the outlet before cleaning. Do not use liquid cleaners or aerosol cleaners.
8. **Do not block any ventilation openings. Install in accordance with the manufacturer's instructions** - Openings in the enclosure, if any, are provided for ventilation and to ensure reliable operation of the apparatus and to protect it from overheating. These openings must not be blocked or covered. This apparatus should not be placed in a built-in installation unless proper ventilation is provided or the manufacturer's instructions have been adhered to.
9. **Do not install near any heat sources such as radiators, heat registers, stoves, air ducts, or other apparatus (including amplifiers) that produce heat.**
10. **Do not install the unit in a place exposed to direct sunlight, excessive dust or humidity, mechanical vibration or shock .**
11. **To avoid moisture condensations do not install the unit where the temperature may rise rapidly.**
12. **Do not defeat the safety purpose of the polarized or ground-type plug.** A polarized plug has two blades with one wider than the other. A grounding type plug has two blades and a third grounding prong. The wider blade or the third prong is provided for your safety. If the provided plug does not fit into your outlet, consult an electrician for replacement of the obsolete outlet.
13. **Protect the power cord from being walked on or pinched particularly at plug, convenience receptacles, and the point where they exit from the apparatus.**
14. **Only use attachments/accessories specified by the manufacturer .** Any mounting of the apparatus should follow the manufacturer's instructions, and should use a mounting accessory recommended by the manufacturer.
15. **Use only with the cart, stand, tripod, bracket or table specified by the manufacturer, or sold with the apparatus.**



When a cart is used, use caution when moving the cart/apparatus combination to avoid injury from tip-over - Quick stops, excessive force, and uneven surfaces may cause the appliance and cart combination to overturn.

16. **Unplug this apparatus during lighting storms or when unused for long periods of time .** – Not applicable when special functions are to be maintained, such as evacuation systems.





17. **Refer all servicing to qualified service personnel. Servicing is required when the apparatus has been damaged in any way, such as power-supply cord or plug is damaged, liquid has been spilled or objects have fallen into the apparatus, the apparatus has been exposed to rain or moisture, does not operate normally, or has been dropped.**
18. **Replacement Parts** - When replacement parts are required, be sure the service technician has used replacement parts specified by the manufacturer or having the same characteristics as the original part.

Unauthorized substitutions may result in fire, electric shock or other hazards.

19. **Safety Check** - Upon completion of any service or repairs to this apparatus, ask the service technician to perform safety checks to determine that the apparatus is in proper operating condition.
20. **Overloading** - Do not overload outlets and extension cords as this can result in a risk of fire or electric shock.
21. **Power Sources** - This apparatus should be operated only from the type of power source indicated on the marking label. If you are not sure of the type of power supply you plan to use, consult your appliance dealer or local power company. For apparatuses intended to operate from battery power, or other sources, refer to the operating instructions.
22. **Power Lines** - An outdoor system should not be located in the vicinity of overhead power lines or other electric light or power circuits, or where it can fall into such power lines or circuits. When installing an outdoor system, extreme care should be taken to keep from touching such power lines or circuits, as contact with them might be fatal.
23. **Object and Liquid Entry** - Never push objects of any kind into this apparatus through openings as they may touch dangerous voltage points or short-out parts that could result in a fire or electric shock.

Never spill liquid of any kind on the apparatus. Should any liquid or solid object fall into the cabinet, unplug the unit and have it checked by qualified personnel before operating it further.

## Labels

	<p>“Lightning Flash Symbol” with the lightning flash with arrowhead symbol within an equilateral triangle, is intended to alert the user to the presence of un-insulated "dangerous voltage" within the product enclosure that may be of sufficient magnitude to constitute a risk of shock to persons.</p>
	<p>“Exclamation Point Symbol” with the exclamation point within an equilateral triangle is intended to alert the user to the presence of important operating and maintenance (servicing) instructions in the literature accompanying the product.</p>

## Note for Power Connections

Check that the voltage of your local power supply is within the operating voltage of the unit. If a voltage conversion is required, consult your DIS dealer or qualified personnel.

Set the Power switch to 'Off' if it is not used for several days.

**Important:** *The equipment must be connected to earth (ground)*

The wires in the main lead supplied with the equipment are colored in accordance with the following codes:

- Green-and-yellow Earth (Ground)
- Blue Neutral
- Brown Live
- The green-and-yellow wire must be connected to the terminal in the plug marked with the letter E or with the safety earth symbol or marked with green-and-yellow color.
- The blue wire must be connected to the terminal marked with the letter N or marked with black color.
- The brown wire must be connected to the terminal marked with the letter L or marked with red color.
- For pluggable equipment, the socket-outlet shall be installed near the equipment and shall be easily accessible.

---

## Power Disconnect

Apparatuses with or without On/Off switches have power supplied to the apparatus whenever the power cord is inserted into the power source; however, the apparatus is operational only when the On/Off switch is in the On position. The power cord is the main power disconnect for all apparatuses.

### Warning:

Operation is subject to the following conditions: (1) The device may not cause harmful interference, and (2) the device must accept any interference received, including interference that may cause undesired operation.

These limits are designed to provide reasonable protection against harmful interference when the equipment is operated in residential, commercial or light industrial environments. The equipment generates, uses, and can radiate radio frequency energy and if not installed and used in accordance with the user manual it may cause harmful interference to radio communications.

Operation of this equipment in residential areas is likely to cause harmful interference in which case the user will be required to correct the interference at his or her own expense. Intentional or unintentional changes or modifications not expressly approved by the party responsible for compliance shall not be made. Any such changes or modifications could void the user's authority to operate the equipment.

If necessary, the user should consult a dealer or an experienced radio/ television technician for corrective action. The user may find the following booklet prepared by the Federal Communications Commission helpful: "How to identify and Resolve Radio-TV Interference Problems". This booklet is available from the U.S. Government Printing Office, Washington, DC 20402, Stock No. 004-000-00345-4.

**Warning:** This is a Class A product. In a domestic environment this product may cause radio interference in which case the user may be required to take adequate measures.

---

## Overview

The Shure Microflex<sup>®</sup> Complete (MXC) Digital Conference System is designed for meetings featuring multiple speakers and active meeting participants. A single system supports MXC and legacy DCS conference units, dedicated interpretation consoles, and integration with SW6000 meeting management software.

Microflex Complete complies with international conference standards, supporting advanced speaker control, simultaneous interpretation, voting functionality, and conference management for up to 3,800 participants.

---

## Information in This Manual

The CCU operates standard in "5900" mode for use in a DDS 5900 system. By uploading a feature license, the CCU can operate in "6000" mode for use in MXC and legacy DCS 6000 systems. This manual describes the CCU when operating in 6000 mode.

For information on operation with the DDS 5900 Discussion system, consult that manual found on the Shure website.

---

## Features

When set to 6000 mode, the CCU has the following features:

- Controls a system of conference units, interpreter consoles, and channel selectors

- Transports secure audio signal with a proprietary codec algorithm
- Provides a web server for advanced control through a browser interface
- Supplies power to the units in the system
- Supports up to 31 interpretation channels for multilingual meetings
- Provides eight audio outputs to send interpretation channels or microphone groups to PA systems, audio mixers, audio recorders, or a language distribution system
- Provides two audio inputs for connecting wireless microphones, processed audio signals, an emergency broadcast message (EEM), or music during meeting breaks
- One rack unit (1RU) size installs into a standard 19" rack

## Feature Licenses

The CCU operates with DDS 5900, legacy DCS 6000, and MXC conference systems. The CCU includes the DDS 5900 mode as standard, and can operate in 6000 mode after installing a feature license.

To use MXC or DCS 6000 conference units, ensure the FL6000 is installed and operating on the CCU.

### Purchasing the Feature License File

Contact your regional Shure sales representative to purchase a feature license file to enable 6000 mode and expansion features. The features are bundled in a single .xml file generated specifically for the serial number of the CCU.

### Adding the License to the CCU

After purchasing the license file, upload it to the unit using the CCU web interface:

1. Save the license file (.xml extension) to the computer or USB drive.
2. Connect the CCU and open the web interface. Sign in as the *Admin* if a password has been set.
3. Go to the *License* page (*System > License*).

*Note: Before the license is loaded to the system, only the DDS 5900 mode is available*

4. Select *Browse* to locate the license file.
5. Select *Go* to install the file to the CCU. The unit will reboot.

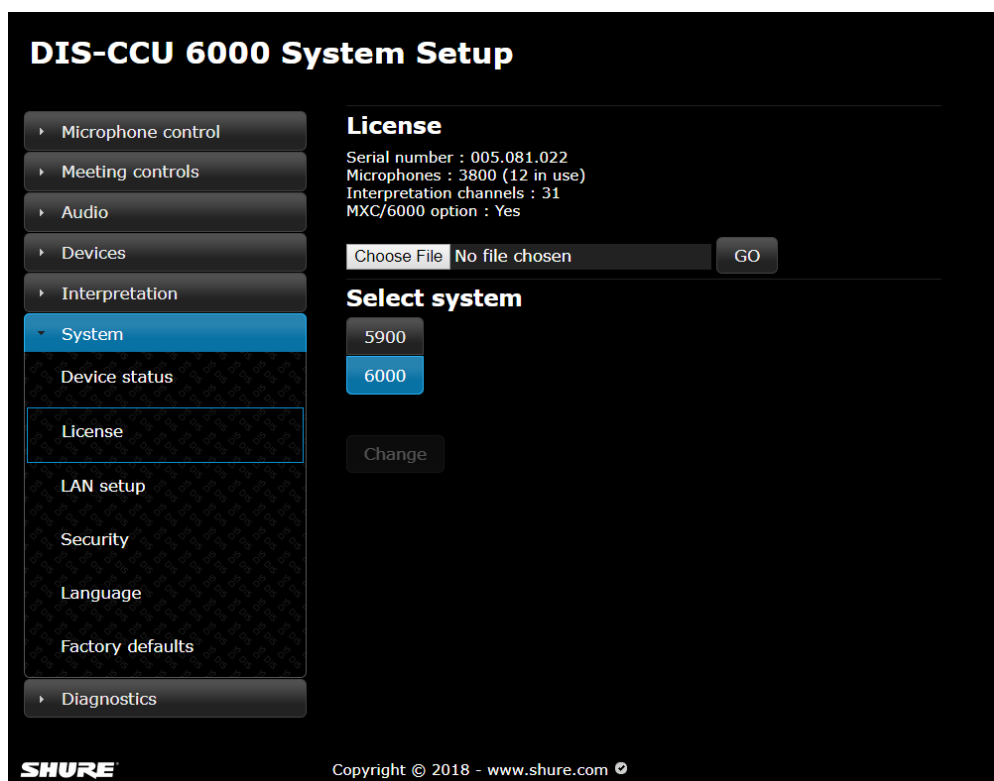

### After Installing the License File

The features are listed at the top of the web page and the mode is selectable for operation with the DDS 5900 or DCS 6000 system.

The CCU Central Unit has the following functionality after FL6000 is installed:

- Conference Units: Max. 250
- Interpretation Channels: Max. 4
- Vox, voice activating: Yes
- Voting: Yes

Units configured in dual mode count as 2 units.

By obtaining additional feature licenses, the functionality can be expanded to include further features like increasing the maximum number of supported conference units to 3,800, or expanding the number of supported interpreter channels to 8, 16, or 31

## Select the System Mode

A CCU with the 6000 license installed can support legacy DCS 6000 or MXC units, as well as retaining DDS 5900 functionality. In 5900 mode, the additional feature licenses are disabled.

**Note:** Conference units cannot be mixed across systems; DDS 5900 conference units only operate in DDS 5900 system mode, while MXC and legacy DCS 6000 units operate in 6000 mode.

Select the system mode:

<b>CCU Front Panel</b>	From the license page: <i>System &gt; License &gt; Select System</i>
------------------------	--

Web Interface

*System > License Info > Select [5900 or 6000] System*

## DIS-CCU Central Control Unit

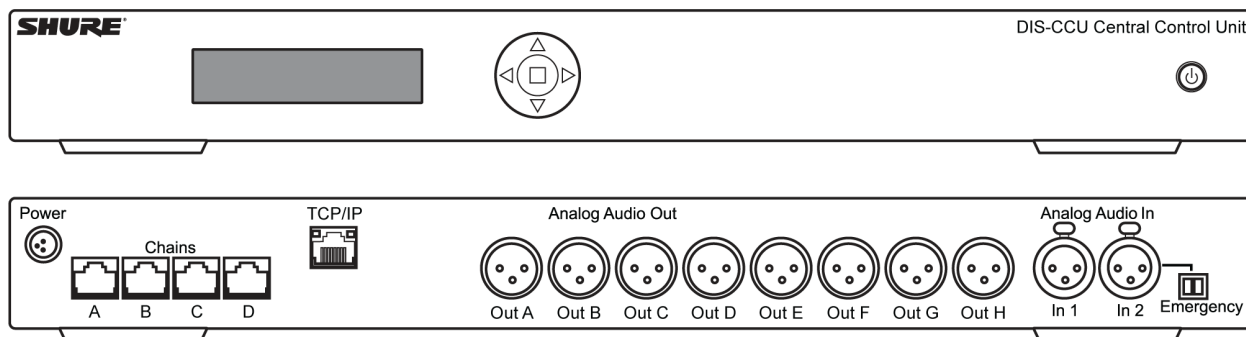

Central control unit for MXC and DIS lines of conferencing systems. Operates with the DDS 5900 system as shipped, and is upgradeable for MXC and legacy DCS 6000 systems with a feature license. Includes a web interface for system configuration, microphone control, and displaying the speaker list during the meeting.

Includes:

- Terminal block for EEM connector
- 19" rack brackets
- USB memory stick with user manuals
- Locking tool for gooseneck microphone

# Simplified Audio Diagram

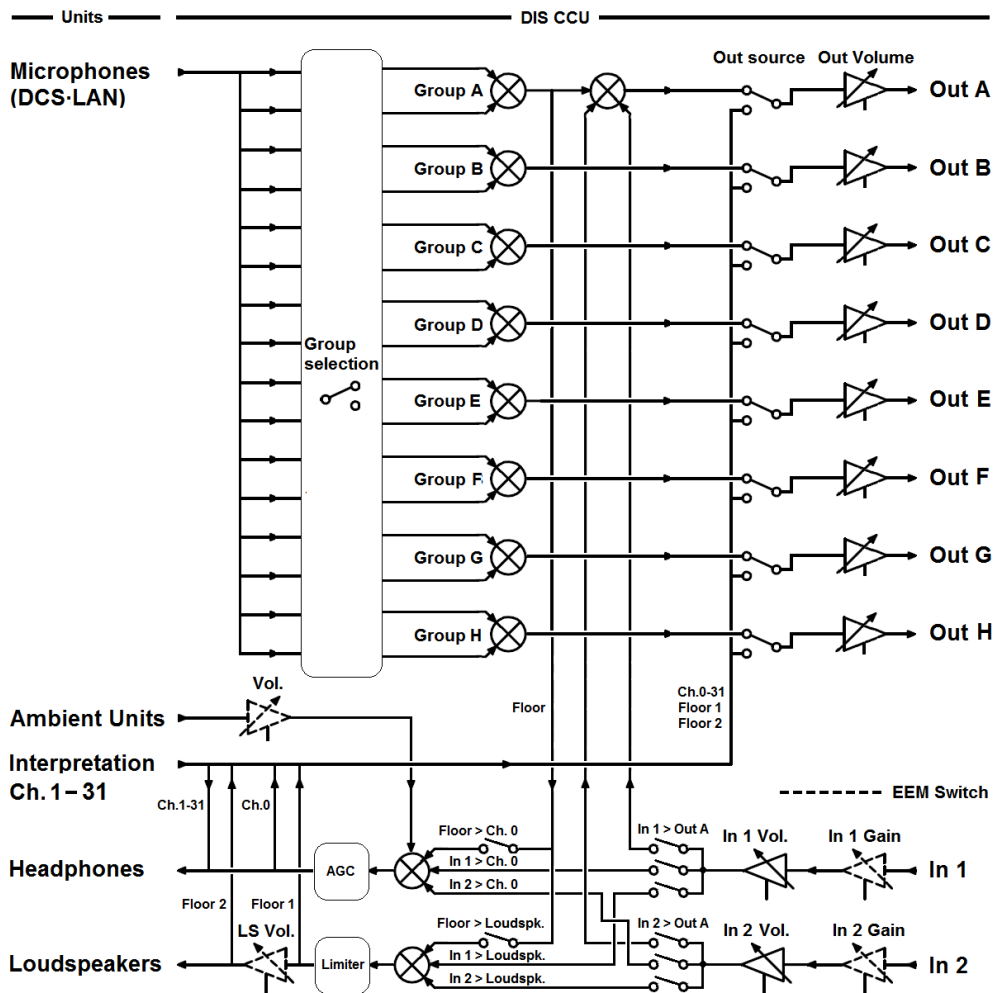

# CCU Hardware Description

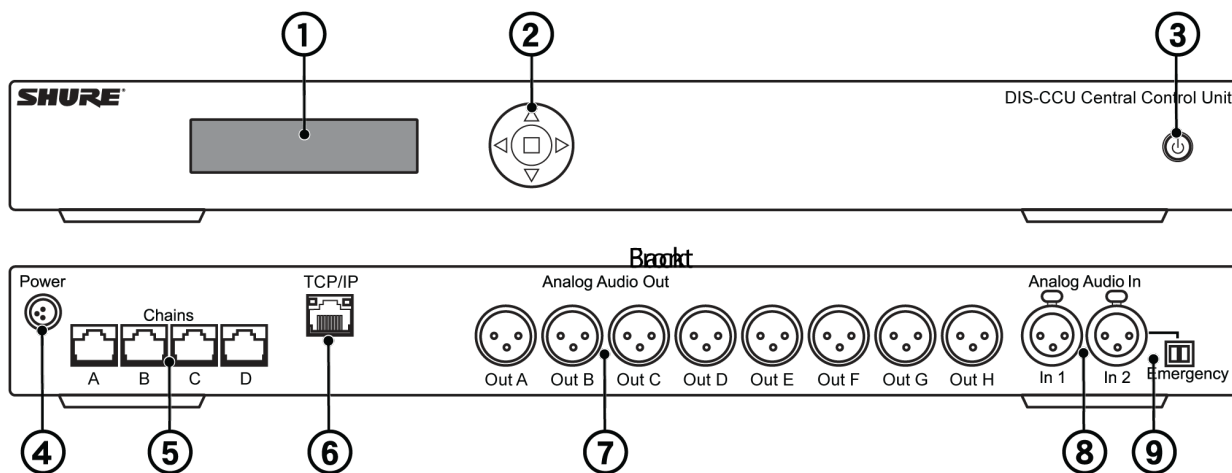

Front Panel	
① Menu display	A 2x20 character OLED-display enables system configuration without a computer.
② Navigation Buttons	5-button keypad for configuring the system without a computer.
③ Power Button	<p>The power button turns on or off the central unit. All connected DCS-LAN units and power supplies will automatically power on or off with the CCU.</p> <ul style="list-style-type: none"> <li>• Green = powered on</li> <li>• Red = powered off but connected to power supply</li> <li>• Off = no power supply is connected to the CCU</li> </ul> <p><i>Note: System settings are stored and persist through a power cycle.</i></p>

Back Panel	
④ Power Supply Connector	Threaded connector secures to the PS-CCU power supply.
⑤ DCS-LAN Outputs	<p>Four RJ45 jacks are available for connecting conference units, forming the DCS-LAN. The DCS-LAN chain safely carries digital audio, control data, and power over the same cable. Use any or all of the four outputs for a variety of layout configurations.</p> <p><i>Important: Only connect DCS-LAN equipment to this output.</i></p>
⑥ Control Connector (TCP/IP)	The RJ45 connector allows access to the built-in web application from a computer, or for connection to a control system like AMX <sup>®</sup> or Crestron <sup>®</sup> .
⑦ Audio Outputs	Eight balanced, male XLR connectors for connection to PA systems, audio mixers, audio recorders, or a language distribution system.
⑧ Audio Inputs	Two balanced, female XLR connector for adding external audio equipment to the meeting, such as wireless microphones, a teleconferencing system, processed audio signals, an emergency broadcast message (EEM), or music during meeting breaks. Input gain and volume are adjust from the CCU front-panel or web application.
⑨ Emergency switch connector	Provides an emergency override signal in the event of an emergency. When the connected switch is closed, the audio signal on Input 2 is distributed to all output channels, overriding all other audio inputs.

## Menu Navigation

The CCU provides controls from the front panel for system setup and configuration. Use the 5-button keypad to navigate the menu and change settings.

The figure below gives an overview of the menu structure.

- Use arrow buttons to cycle through menu items
- Press enter (center) button to navigate to an editable field.
- Use up/down buttons to cycle through the available values

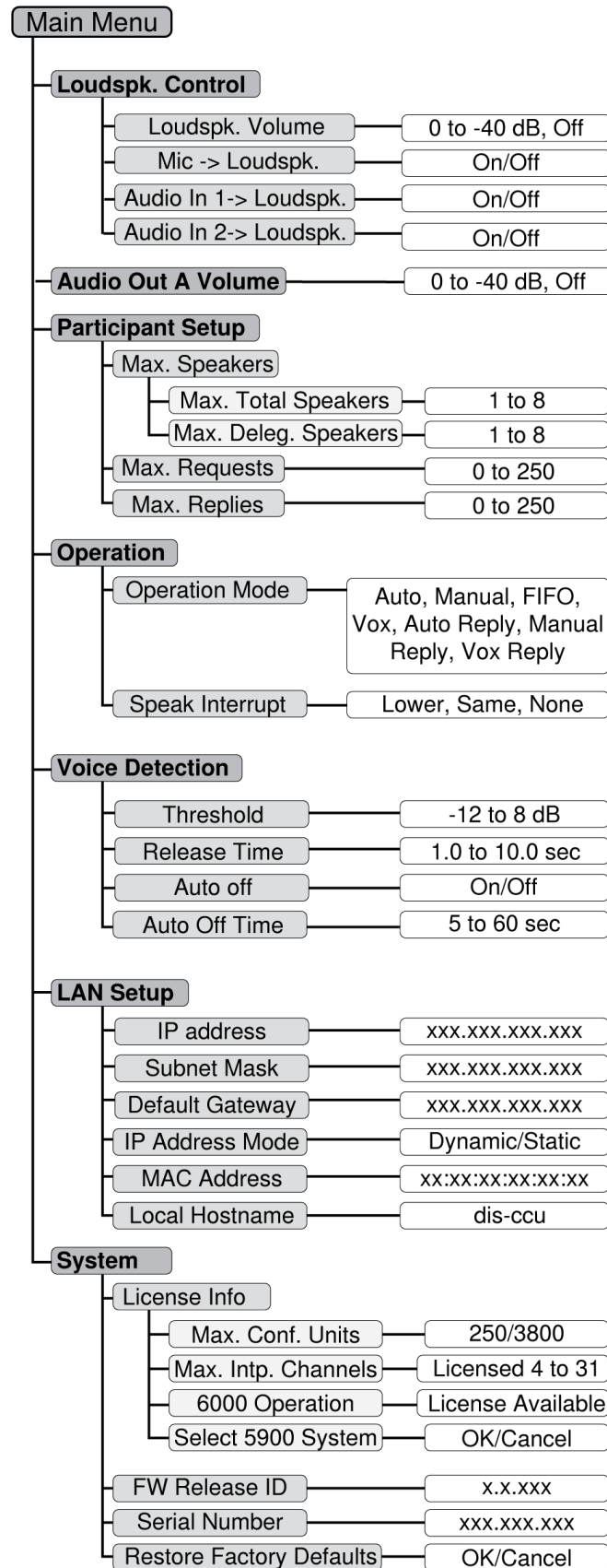

Menu Overview - DCS 6000 Mode



# MXC Conference Units

MXC conference units facilitate communication between participants in group meetings and conferences. The units enable participants to speak and be heard with clarity, even in large and multilingual events, by combining a gooseneck microphone, loudspeaker, headphone jack, and user controls. For advanced meeting tasks, some conference units include features for voting, following along to the agenda, managing speakers, and more.

**Note:** Speaker and meeting management settings are highly configurable and can be tailored to meet your event requirements. See meeting setup for more information.

## Conference Unit Hardware Descriptions

Not all features available on all MXC conference units.

①	Function Button (left button)	Used for a variety of functions relating to speaking and participant management. By default, this button mutes the participant's microphone.
②	Speak Button (right button)	The speak button is used to control a participant's microphone and a variety of functions relating to speaking and participant management.
③	Headphone Output	3.5mm jack, used for assisted listening of floor/loudspeaker audio, as well as interpreter audio.
④	NFC Card Reader Slot	Enables participants to login and verify using a Shure NFC card.
⑤	Volume Control	Increases and decreases audio playback volume.
⑥	Channel Selector	Selects the audio channel for the headphone output.
⑦	Channel Indicator	OLED display to indicate the selected interpretation channel.
⑧	Microphone Input	Lockable connector, compatible with Shure Microflex gooseneck microphones.
⑨	DCS-LAN Network Connection	RJ-45 in/out ports provide power, audio, and control information on the same cable.
⑩	Loudspeaker	Provides individual, localized audio signal of the floor mix.
⑪	Voting Buttons	Configurable for 2-, 3-, and 5-button voting sessions.
⑫	Front-Plate Connectors	Connection (Port A and Port B) for flush-mounted interface plates. The cable carries audio and data information to and from the front plate.
⑬	XLR Input	Mic/Line audio input. Select between Port A and XLR-Mic / XLR-Line in the device setup menu. XLR input is disabled in dual mode.



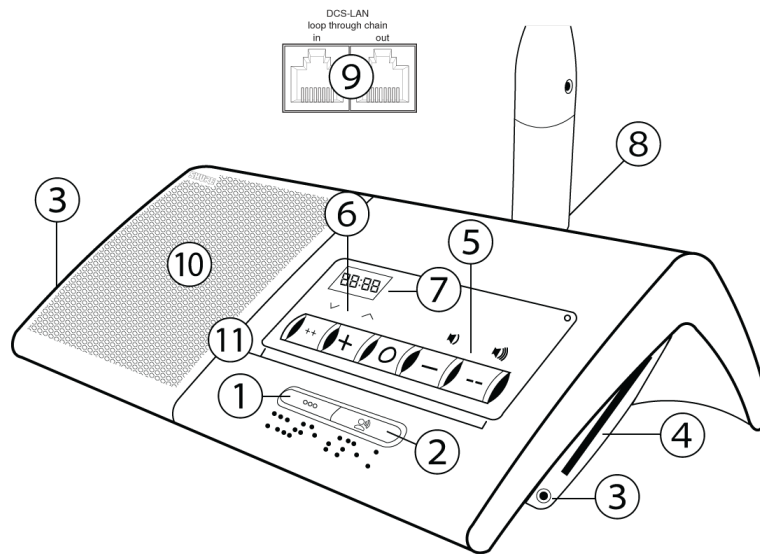

## MXC640 Touchscreen Conference Unit

Conference unit with touchscreen controls, voting capability, participant identification using NFC card, dual-language channel selector, and integrated Braille 'Mute/Speak' labels for speak and function buttons. Supports chairman, delegate, and dual-delegate roles.

**Note:** NFC is not supported with dual-delegate roles.

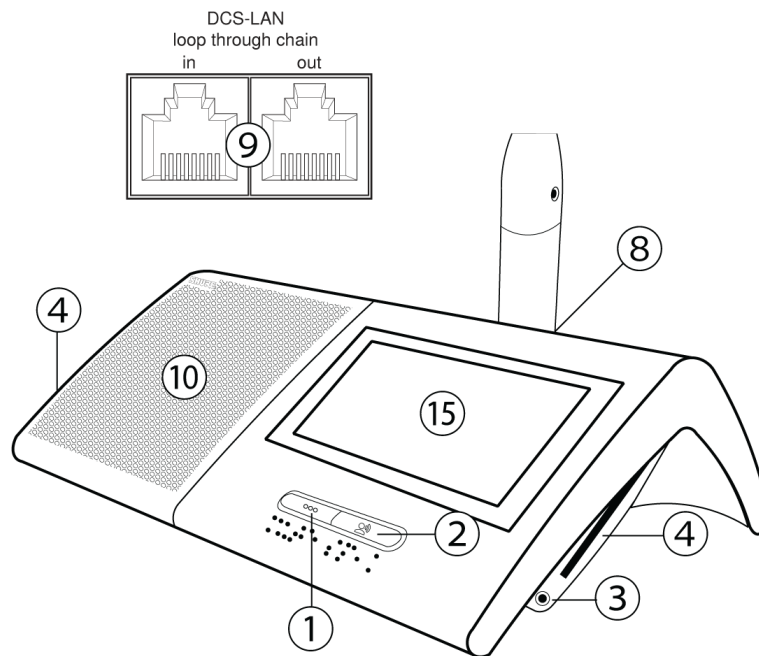

## Flush-Mounted Model Variations

The Flush-mounted conference unit variants install permanently into a table or podium. A low-profile design conceals the base and cabling below the tabletop surface.

### MXC620-F Conference Unit

Flush-mounted conference unit featuring NFC card participant identification and single-language channel selector. Supports chairman and delegate roles.

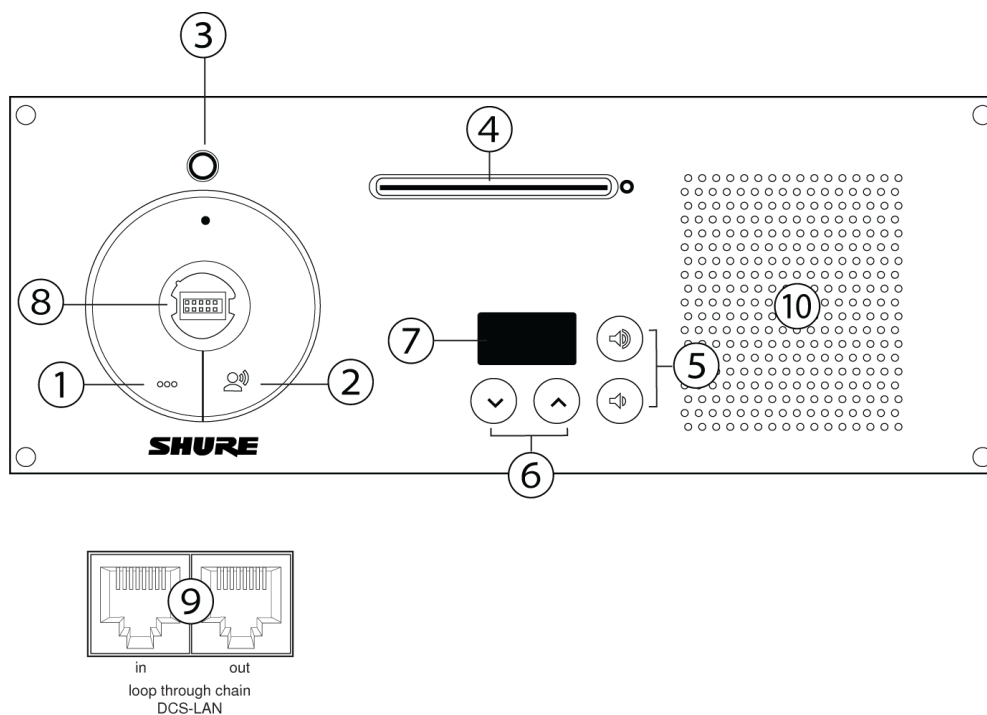

### MXC630-F Voting Unit

Flush-mounted voting conference unit with NFC capability, single-language channel selector. Supports chairman and delegate roles.

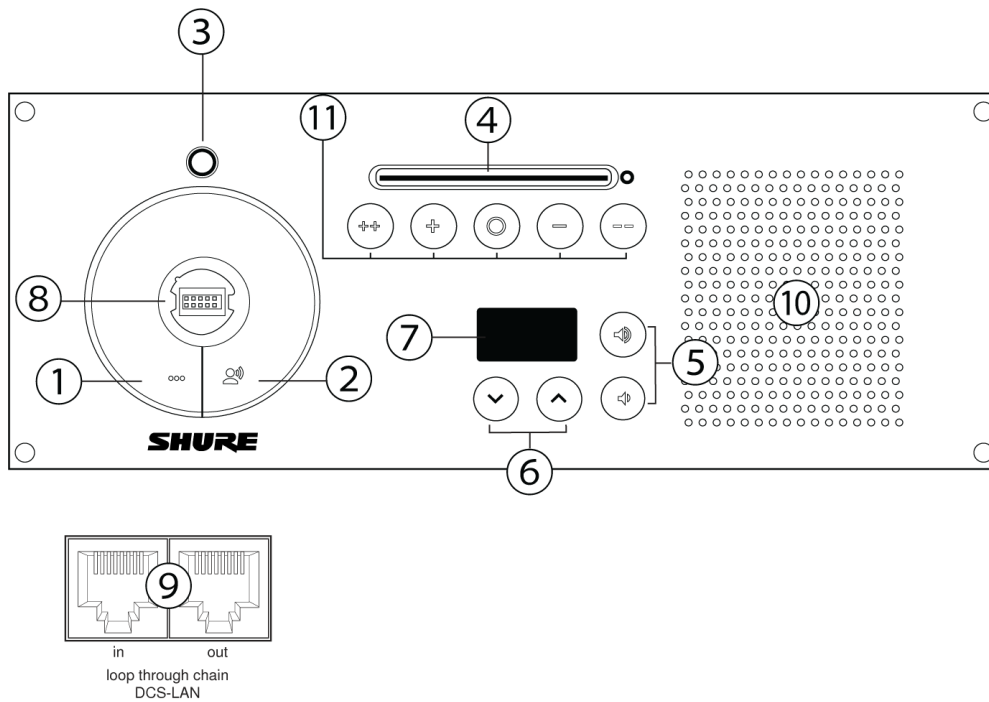

## MXCMUI Multi Interface Unit

A compact conference unit for applications with limited mounting space. For use with Flush-Mounted Interface Plates via Port A and Port B, or external source audio through the XLR input. Supports chairman, delegate, and dual-delegate roles.

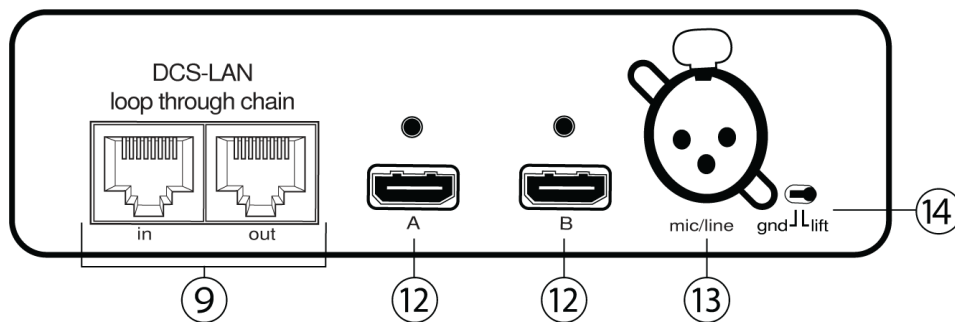

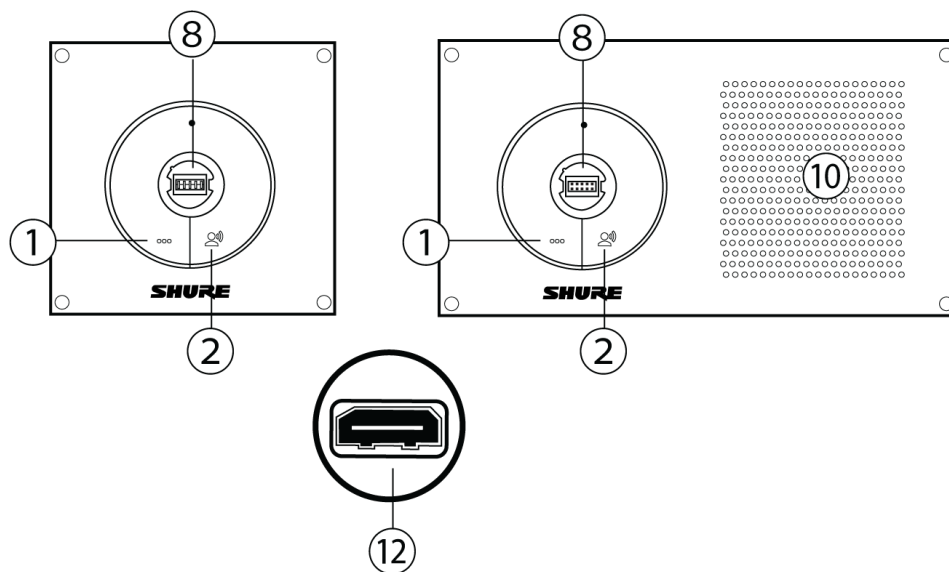

MXCMUI-FS | MXCMUI-FL Flush-Mounted Interface Plates

## NFC Card functionality

NFC card functionality is a feature where participants identify or log themselves into the system by use of an MXC NFC card.

In a standalone system, the card identifies the participant by name. Use the free Shure NFC Card Programmer application (available on [www.shure.com](http://www.shure.com)) and an authorized NFC card programmer device to encode this information on a supported NFC card.

When used with SW6000, the NFC card contains the information Participant ID, Login Code and Location ID, which the Microflex<sup>®</sup> Complete system uses to login and verify the participant using the SW6000 database. The functionality in general is explained in the SW6000 CAA User Manual.

One card can contain information for both standalone mode systems and for use with SW6000.

## Microflex Multipin Gooseneck Microphones

Lockable gooseneck microphones for use with MXC/MXCW conference units.

- Commshield<sup>®</sup> Technology eliminates RF noise
- Lockable 10-pin connector
- Built-in red/green/yellow LED indicator
- Compatible with MX-series omni, supercardioid, and mini-shotgun cartridges
- Available in 16 inch/40 cm or 20 inch/50 cm lengths, with optional Dualflex configuration

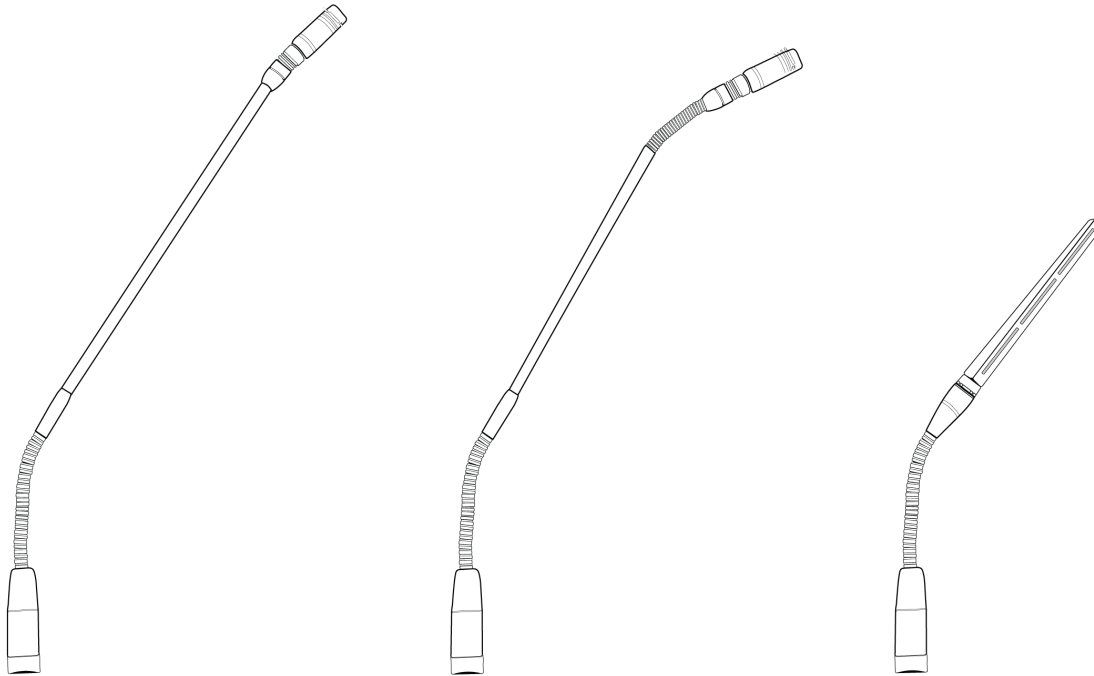

## Snap-Fit Windscreen

- Snap into the groove below the cartridge.
- To remove, spread the gap with a screwdriver or thumbnail.

**Important:** To avoid damaging the windscreen, always detach properly before removal

- Provides 30 dB of "pop" protection.

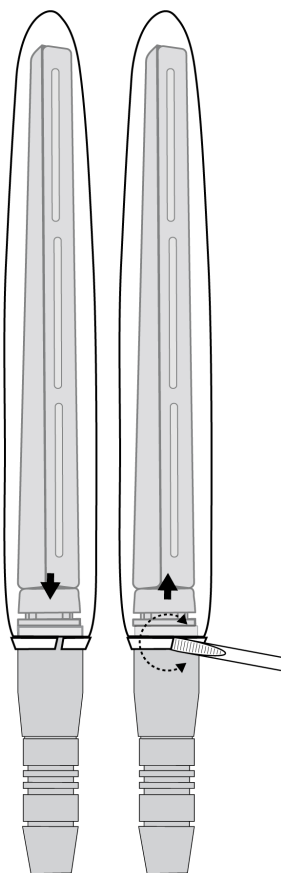

## Connecting Conference Units and DCS-LAN Components

Conference units and DCS-LAN components are connected in sequence (daisy-chain) using the two RJ45 ports on each unit. Connectors are **not** interchangeable: the previous unit must be connected to the *IN* port, and the following unit to the *OUT* port.

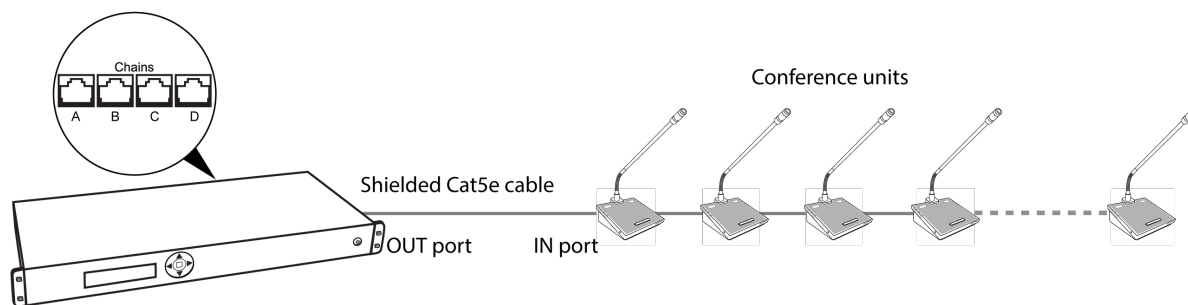

*Power, control data, and audio are transported from one unit to the next over the same shielded Cat5e cable.*

To protect the equipment, ensure that the central control unit (CCU) **is always off** when connecting or disconnecting the conference units. Use any of the four chain connectors (A, B, C, and/or D) for connecting DCS-LAN components.

1. Power off the CCU to protect the equipment during set up.
2. Connect a chain output on the CCU to the first conference unit with the shielded Cat5e cable.
3. Connect the rest of the conference units in sequence, using the RJ45 jacks on the bottom of each unit.



4. Use the included cable clamp to secure the cables in place.
5. Turn on the CCU by pressing the power button. The conference units will power on. The unit is stable once the control button LEDs stop flashing.

**Warning:** Do not turn off CCU power until the system has stabilized

## Connection Diagrams

The following system diagrams illustrate typical hardware connections to the CCU. Actual installations may use different combinations of hardware, but follow the general concepts outlined below.

**Note:** Flush-mount and portable conference units are interchangeable in the following drawings, unless noted.

## Basic Setup with Conference Units

The system is operational without the use of a computer. Use the CCU navigation screen to change the speak operation setting if needed. Use the CCU web interface if advanced setup options are needed.

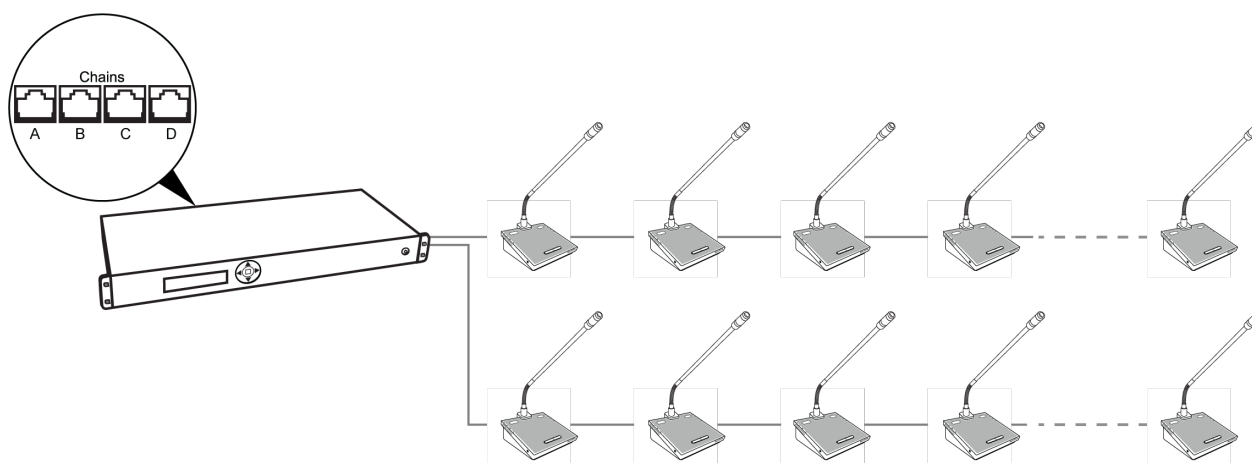

**Basic System with Multiple Chains**

## Redundancy

The system is operational without the use of a computer. Use the CCU navigation screen to set up the installation.

Cable redundancy in an MXC system can be achieved by connecting the DCS-LAN OUT port of the last MXC conference unit to an MXC Redundancy Interface Box (MXC-ACC-RIB), and looping back to a DCS-LAN port on the CCU.

**Note:** Systems including legacy DIS units do not support cable redundancy.

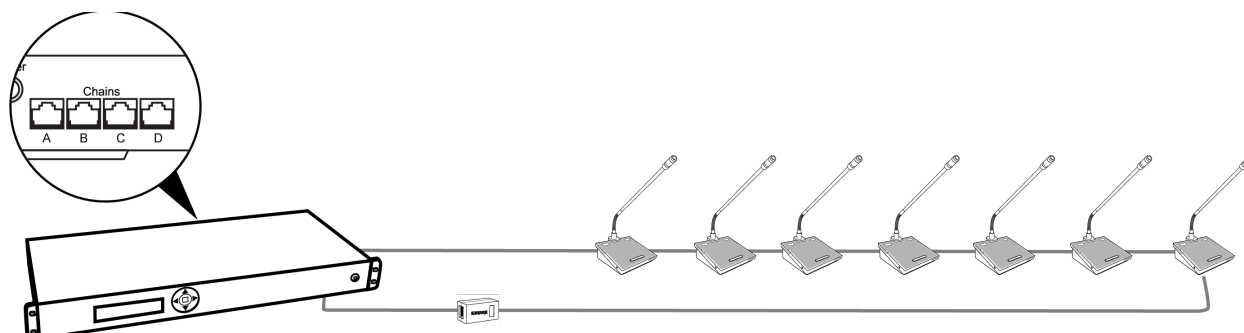

**Basic System with Redundant Cabling**

## Computer for Advanced Control

Connect a computer to the CCU for comprehensive management of the system through a web browser. Connect an Ethernet cable from the dedicated *TCP/IP* port to a computer.

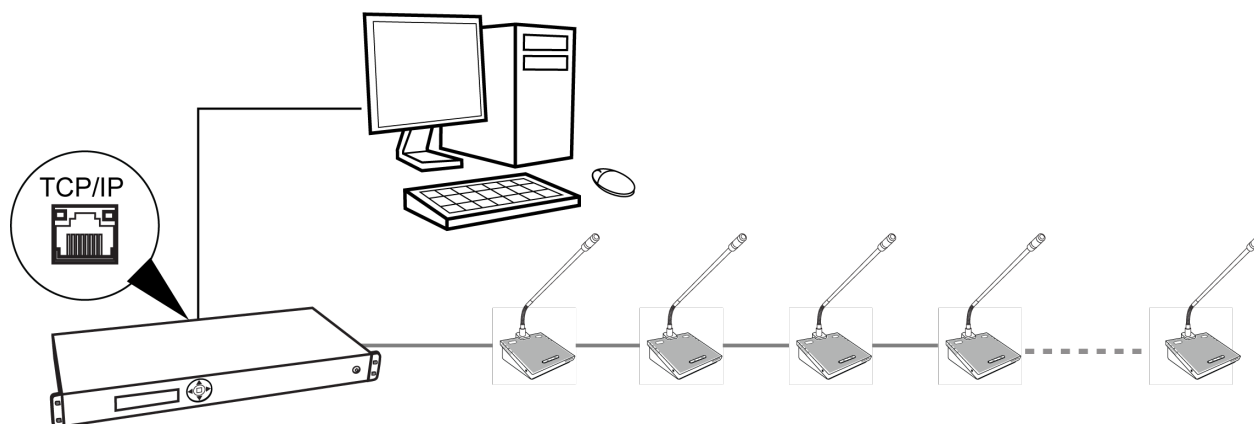

Connect the CCU TCP/IP port to computer

## Mixer or DSP

Connect a mixer to the CCU analog outputs to control individual microphone volume or equalization. Use the browser interface to buss units to groups and assign them to the specific output (A-H).

To return the audio to the DCS 6000 system:

1. Connect the output of the external device to Audio Input 1 on the CCU
2. Route the Input 1 audio by selecting the Loudspeaker and Ch. 0 and deselecting Out A (Group) *Audio > Input - Control > Audio In 1*
3. To avoid a feedback loop, turn off the internal Floor routing by deselecting Loudspeaker and Ch. 0: *Audio > Input Control > Floor*

Analog outputs to DSP

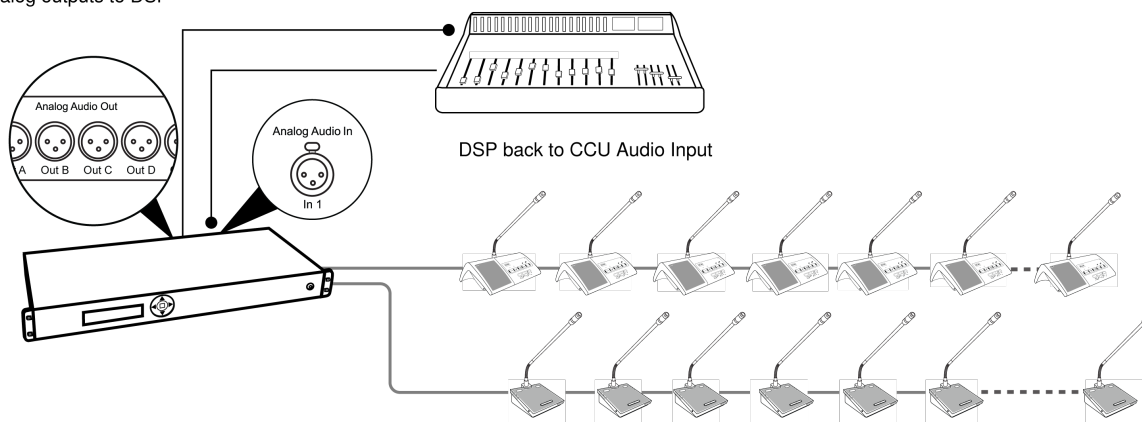

Inserting a Mixer or DSP

## Tablet or Laptop for Wireless Control

Use a wireless router to access the web browser from a laptop or tablet. The web browser on a mobile device offers the same comprehensive system management.

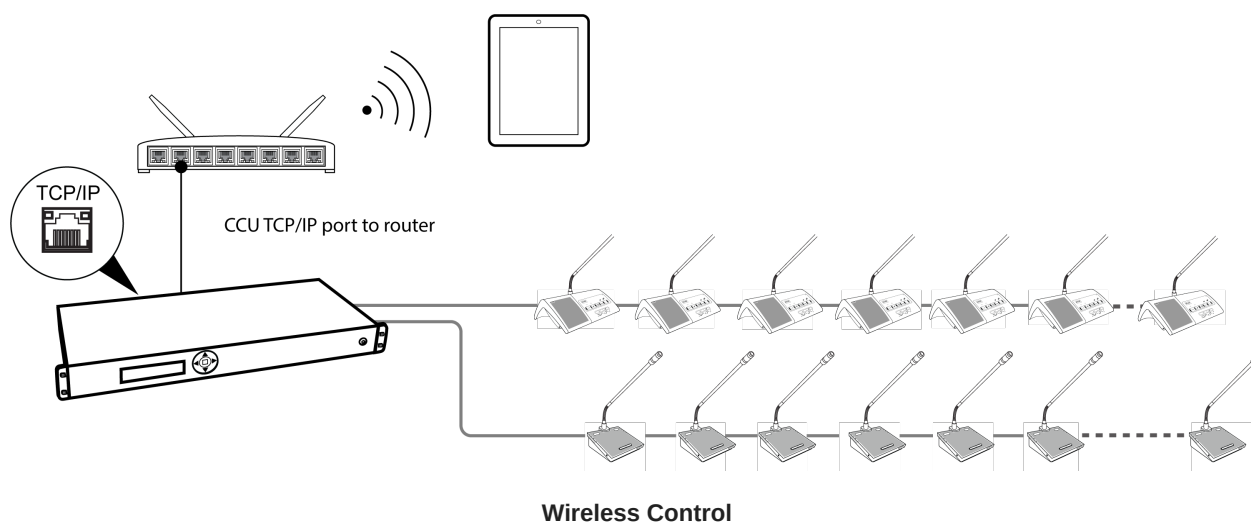

## Audio Recorder

Connect an audio recorder to the analog outputs of the CCU to record floor audio, translations, or a specific set of microphones. Use the browser interface to buss units to groups and assign them to the specific output (A-H). Connect the XLR outputs of the CCU to the inputs of an audio recorder.

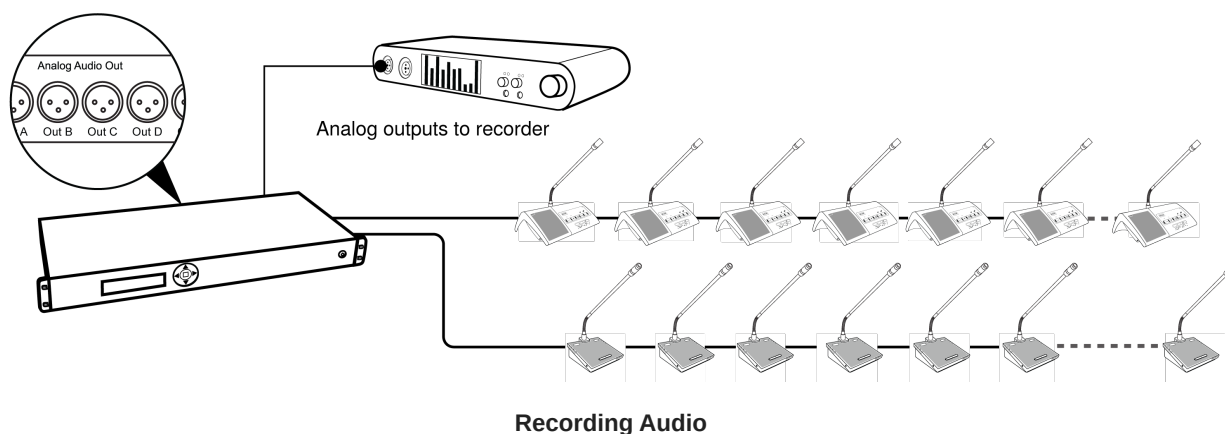

## Controlling the Conference Unit

MXC conference units are configurable to support the Chairman or Delegate role of the participants in a meeting. Roles are set in the CCU web app in the Participants setup. The default role is Delegate. All conference units contribute by default to the main audio (floor) mix.

## Chairman Role

As the leader of the event, the chairman has several unique features enabled on the Conference Unit.

- **Speak button:** Turns on the microphone. The chairman can always turn on the microphone, overriding delegate units as long as the maximum number of open microphones has not been exceeded.

*Note: Microphone status is displayed by the button and microphone LEDs:*

- Red = microphone is on
- **Function button:** The chairman's function button can be programmed to the following functions:
  - Mute: Mutes the audio from the microphone.
  - Mute all: Mutes the audio from all open delegate microphones.
  - All delegates off: Turns off all delegate microphones.
  - Exclusive: Mutes all delegate microphones and activates the chairman microphone (delegate microphones are unmuted when released)
  - Next on: Turns on the first request on the request list
  - Reply: Places the chairman in the Reply list (if the speak mode supports Reply functionality).

## Delegate Role

The number of simultaneous delegate speakers is limited, requiring different control buttons to participate in the discussion:

- **Speak button:** Turns on the microphone or adds the user to the request queue, depending on the speak mode.

*Note: Microphone status is displayed by the button and microphone LEDs:*

- Red = microphone is on
- Green = microphone is in the request queue
- **Function button:** Delegate function buttons can be programmed to the following functions:
  - Mute: Temporarily mutes the audio from the microphone.

**Note:** While the button is pressed, the delegate retains speaking privileges but the microphone will not pass audio.

- Reply: The reply functionality places the participant in the Reply list if the speak mode supports Reply

## Dual Delegate Role

In this configuration, two participants are sharing a single conference unit. Both the left and right buttons are configured as Speak buttons, one for each participant.

Dual delegate functionality can be configured on the following units through the CCU:

- **MXC615**

*Note: Mute and Reply functionality is disabled in dual delegate mode*

- **MXC620**

*Note: Mute and Reply functionality is disabled in dual delegate mode*

- **MXC640**
- **MXCMIU**

The microphone and loudspeaker are shared on MXC615, MXC620 and MXC640 dual units. MXCMIU dual units support individual front plates for each participant.

## User Indications

<b>Speak LED</b>	Red indicates the microphone is ON		
<b>Mute LED</b>	Blue indicates the microphone is muted		
<b>Request LED</b>	Green indicates the microphone has been added to the request queue (see 'Speak modes')		
<b>Reply LED</b>	Green indicates the Reply function is active		
<b>All Delegates Off</b>	Blue indicates all Delegate conference units are muted		
<b>Exclusive LED</b>	Orange indicates Exclusive mode is active		
<b>Next On LED</b>	Red indicates the Next On function has been activated		
<b>Microphone Light Ring</b>	Red indicates the microphone is ON	Green indicates a participant request to speak	OFF indicates the microphone is muted

## Web Interface

For comprehensive management and remote control of the system, open the web interface on a computer or tablet. The CCU provides a web server for system control from a web browser on a networked computer. The web interface offers advanced parameters for setting up the system, and enables the chairman or moderator to manage microphones using participant names and seat numbers. The interface supports up to 6 simultaneous connections.

**Note:** The computer network is separate from the DCS-LAN network used by conference units.

## DIS-CCU 6000 System Setup

- ▶ Microphone control
- ▶ Meeting controls
- ▶ Audio
- ▶ Devices
- ▶ Interpretation
- ▼ System
  - Device count
  - License
  - LAN setup
  - Security
  - Language
  - Factory defaults & backup
- ▶ Diagnostics

### Device count

Chain	Found	Lost
A	10	0
B	4	0
C	0	0
D	0	0

**SHURE** Copyright © 2019 - [www.shure.com](http://www.shure.com)

### System Requirements

For best performance, always update the browser to the latest released version. The following browsers function properly with the system interface:

- Internet Explorer (IE) 8+
- Safari
- Chrome

## Open the CCU Web Interface

Follow these instructions to open the web interface on a computer.

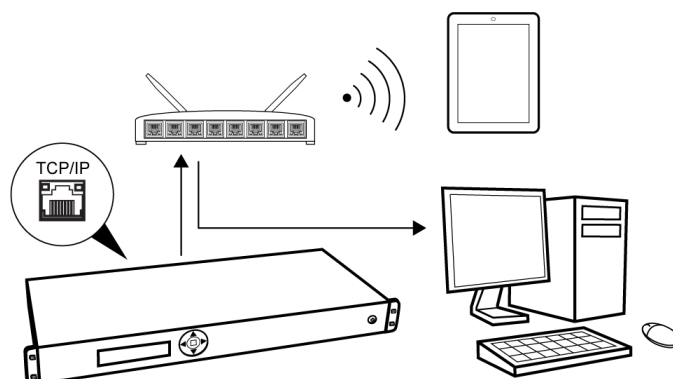

## Connect to the CCU

1. Connect the computer to the *TCP/IP* port on the CCU.
2. Power on the equipment.
3. Assign the computer to automatically obtain an IP address. This enables the computer to automatically connect to the CCU.
4. Acquire an IP address by selecting *LAN Setup > IP address mode > Dynamic*.
5. View the IP address: *LAN Setup > IP address*.
6. Open the web browser on the computer.
7. Type <http://IP-address>, where "IP address" is the address noted from the CCU.
8. The browser interface opens the Admin screen.

## Assigning the Network Address

Access to the web interface is available from two network addresses: IP address and hostname. Typing either address into a browser will access the interface of the connected CCU.

Manage the network address from the web browser: *System > LAN Setup*

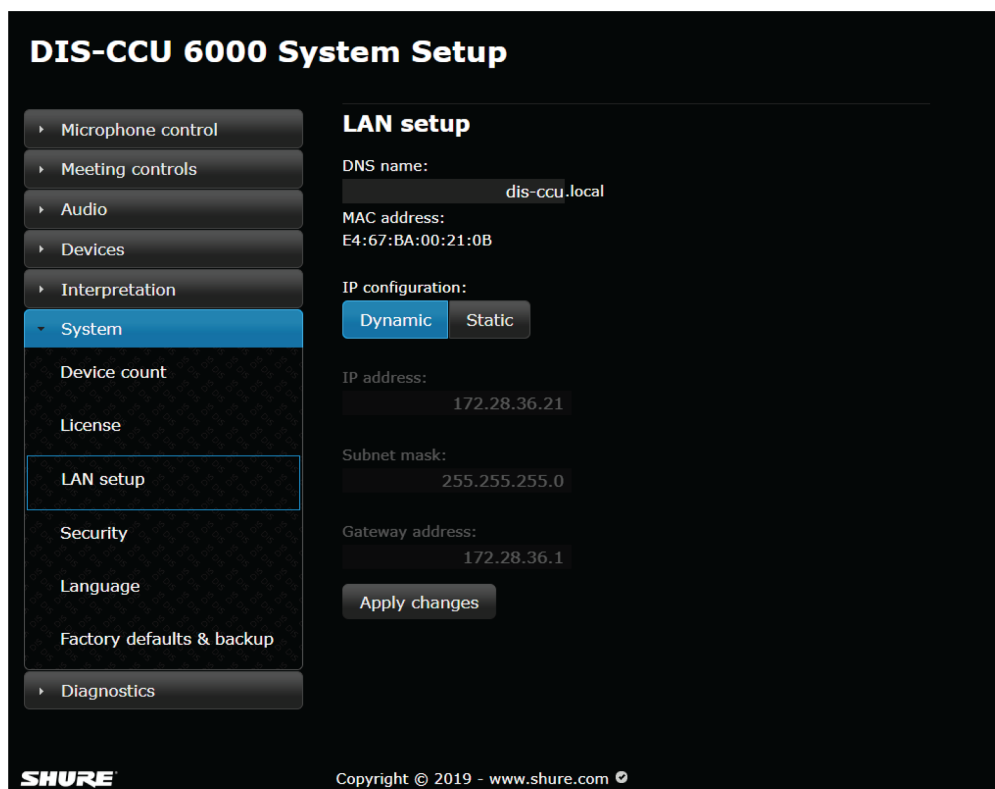

## Additional Screens

In addition to Admin access to the web interface, there are two separate screens useful during the meeting:

- Microphone control screen for speaker management, used by Chairman or moderator.
- Display screens to view the speaker and reply/request lists, used on a large screen for reference by participants or audience.

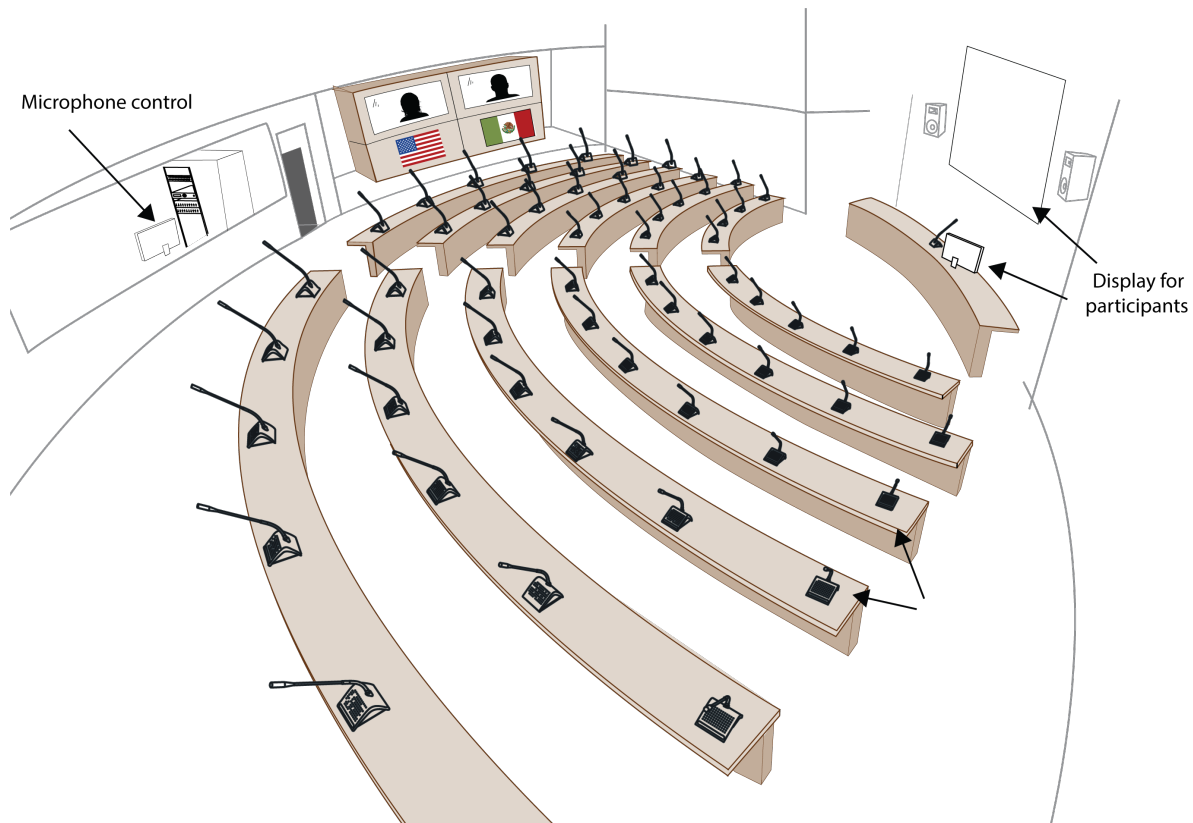

By default, anyone can access these views from a computer or mobile device connected to the network. To protect these pages, the administrator can assign a password to each from the *Security* page.

## Microphone Control Screen

This screen is dedicated for microphone control during the meeting. Use this screen as a chairperson or meeting operator to manage speakers, speak requests, and replies.

For access, enter the IP address of the CCU, followed by */chairman* (example: <http://172.17.11.137/chairman>).



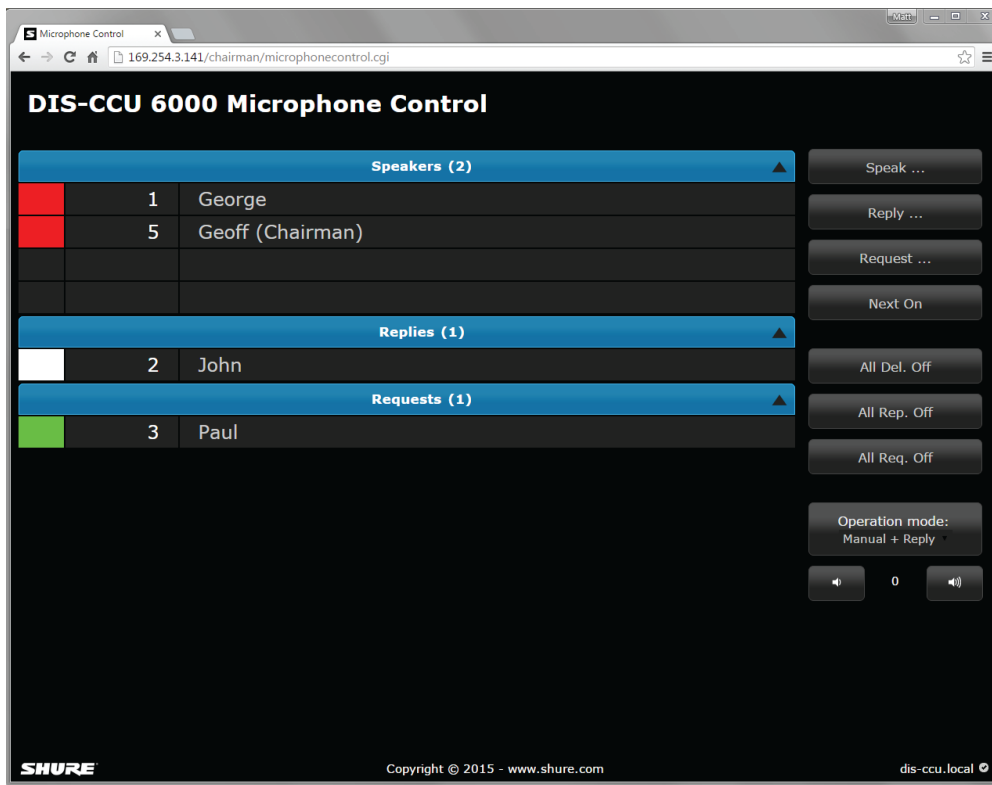

## Display Screen

The display screen is used to provide spectators with a view of the speaker, request, and reply lists.

For access, enter the IP address of the CCU, followed by */display* (example: <http://172.17.11.137/display>).

**Tip:** Put the page in full-screen mode during the meeting:

- PC: *F11*
- Mac: *ctrl + cmd + f*

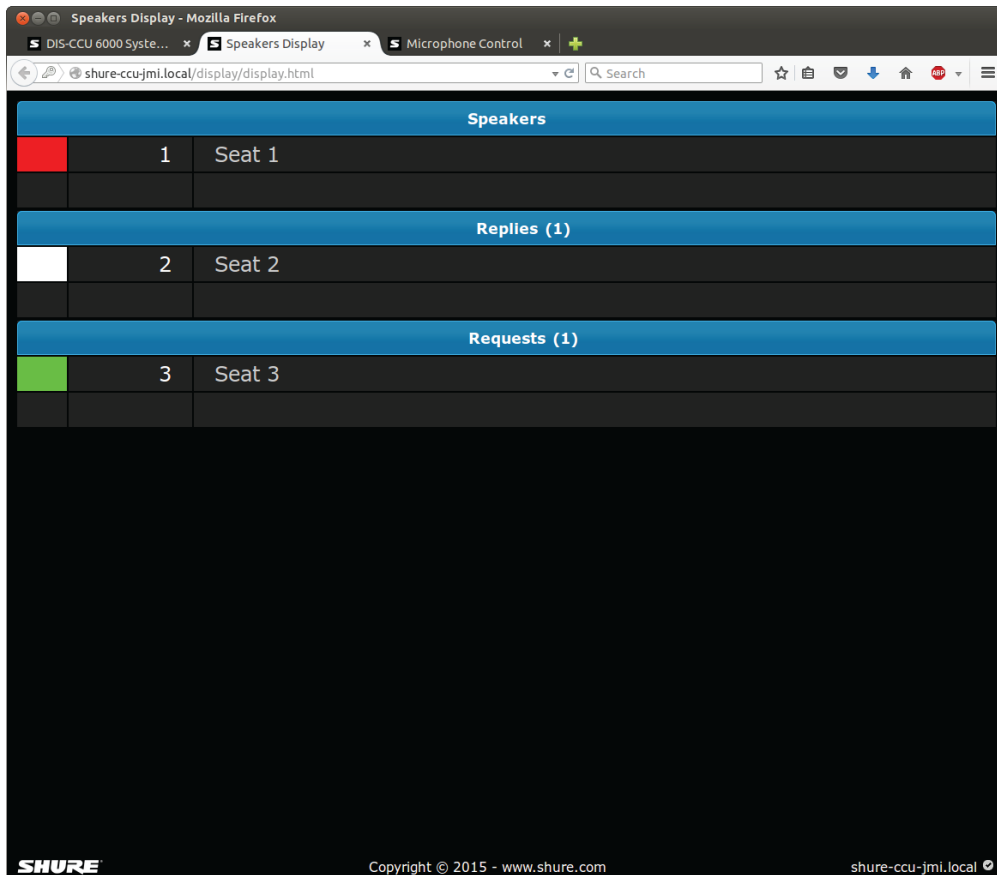

## Language Setting

The browser interface is supported in a variety of languages. Go to *System > Language* to select the desired language.

Albanian	Shqip
Arabic	اللغة العربية
Bosnian	Bosanski
Bulgarian	български
Chinese (Simplified)	中文 (简体)
Chinese (Traditional)	中文 (繁體)
Croatian	Hrvatski
Czech	Čeština
Danish	Dansk
English	English
French	Français
German	Deutsch

<b>Greek</b>	Ελληνική
<b>Icelandic</b>	Íslenska
<b>Italian</b>	Italiano
<b>Japanese</b>	日本語
<b>Korean</b>	한국인
<b>Macedonian</b>	македонски
<b>Montenegrin Cyrillic</b>	Црногорски
<b>Montenegrin Latin</b>	Crnogorski
<b>Norwegian</b>	Norsk
<b>Persian</b>	فارسی
<b>Polish</b>	Polski
<b>Portuguese</b>	Português
<b>Russian</b>	русский
<b>Serbian Cyrillic</b>	Српски
<b>Serbian Latin</b>	Srpski
<b>Slovenian</b>	Slovenski
<b>Spanish</b>	Español
<b>Swedish</b>	Svenska
<b>Thai</b>	ภาษาไทย
<b>Vietnamese</b>	Tiếng Việt

## User Interface for the MXC640

### Start-up screen

When the system is powered up, an initialization and start-up screen appears, which may include a participant name.

If a meeting has been started in the SW6000, it may also include the meeting name



To activate the console, touch the LCD touch screen or insert an NFC card.

If SW6000 is connected, a login screen may appear depending on the Meeting Mode. Please consult the SW6000 user guide for login options.

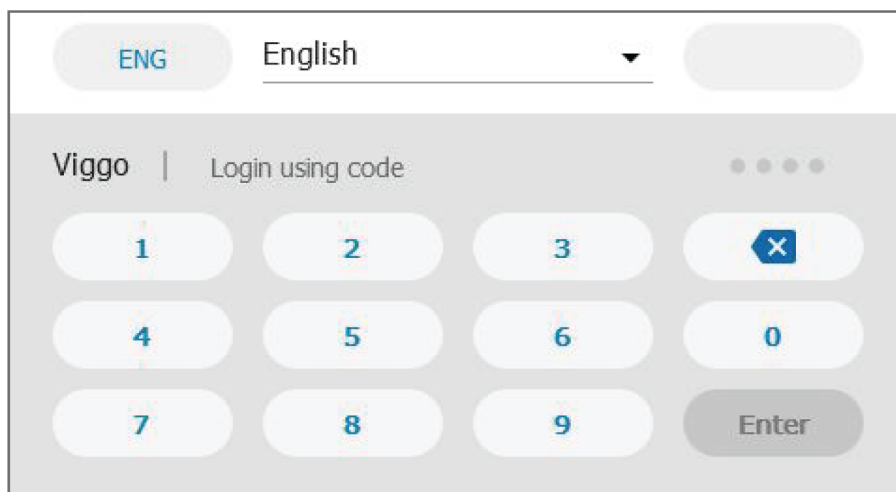

## Navigation Pane

When the user leaves the start-up screen, the Home screen appears. At the top of the screen is the navigation pane, for moving between different screens to access different options and information.



① Headphone Language and volume selection (only visible if a headphone is connected)

- ② Home
- ③ Start Meeting/Agenda (only in use when connected to SW6000)
- ④ Voting/Results
- ⑤ Settings

## Home Screen

The Home screen for the Delegate role includes a combined speaker/reply/request list with scroll functionality, and a configurable software button. The default functionality is Reply, but automatically switches to Mute if the *Function* button is configured as Reply.

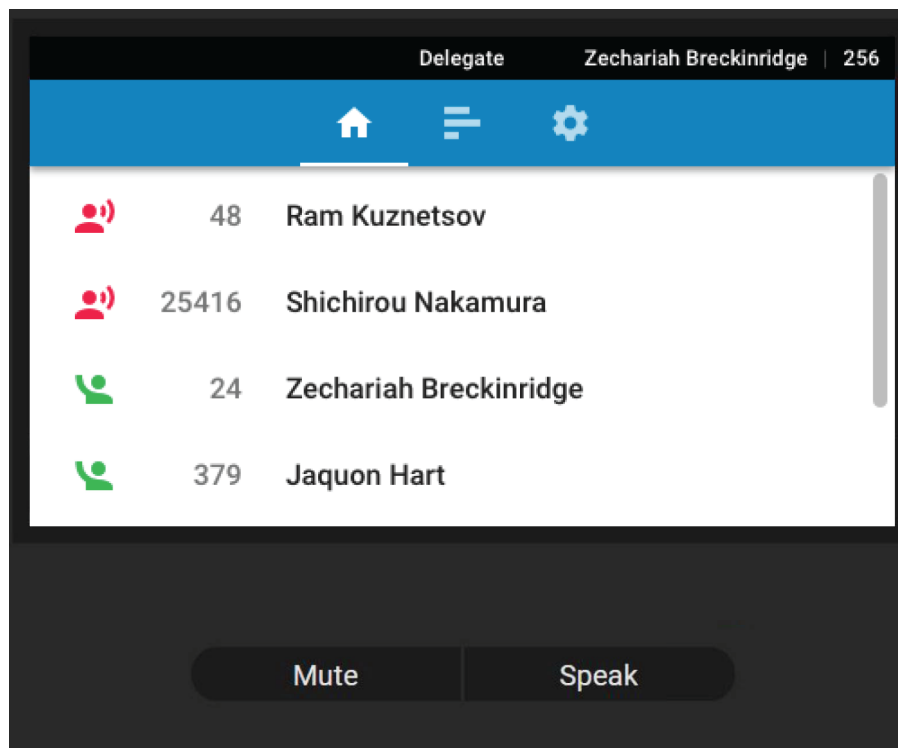

The Chairman console home screen includes a number of software buttons, which change functionality depending on the configuration of the *Function* button, the selected item in the lists, and the Speak mode. The following functionalities are available:

<b>Mic on</b>	Turns on the microphone of the selected entry in the reply/request list
<b>Mic off</b>	Turns off the microphone of the selected entry in speakers list
<b>Next on</b>	Turns on the microphone of the first entry in the reply/request list
<b>Mute</b>	Mutes the selected microphone while the button is activate, without removing the right to speak
<b>Mute all</b>	Mutes all delegate microphones while the button is activate
<b>Reply</b>	Places the participant into the reply/request list
<b>Reply off</b>	Removes the selected entry from the reply/request list
<b>All replies off</b>	Removes all reply entries in the reply/request list

<b>Request off</b>	Removes the selected entry from the reply/request list
<b>All req off</b>	Removes all request entries in the reply/request list
<b>All del off</b>	Turns off all delegate microphones
<b>Exclusive</b>	Mutes all delegate microphones and activates the chairman microphone while the button is active

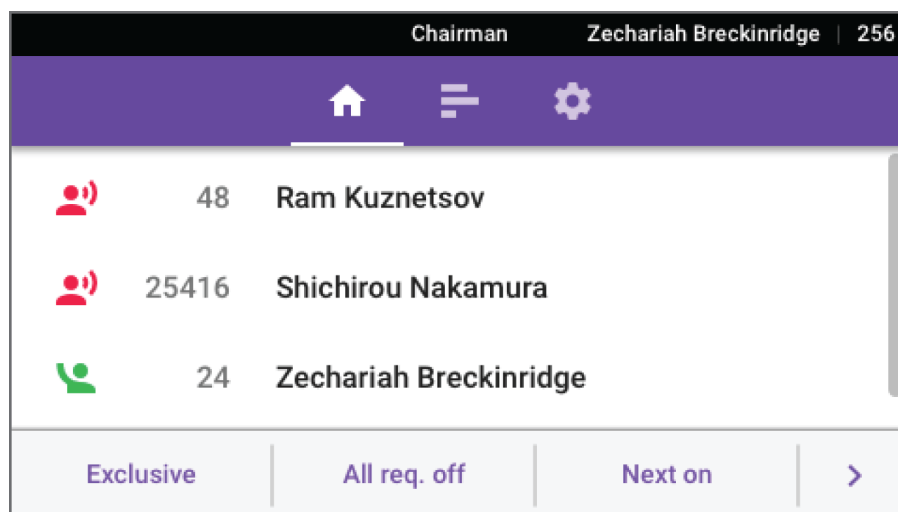

## Agenda

If SW6000 is in use, the Agenda screen displays the agenda for an active meeting. Selecting an item displays full details. The agenda is created in SW6000.

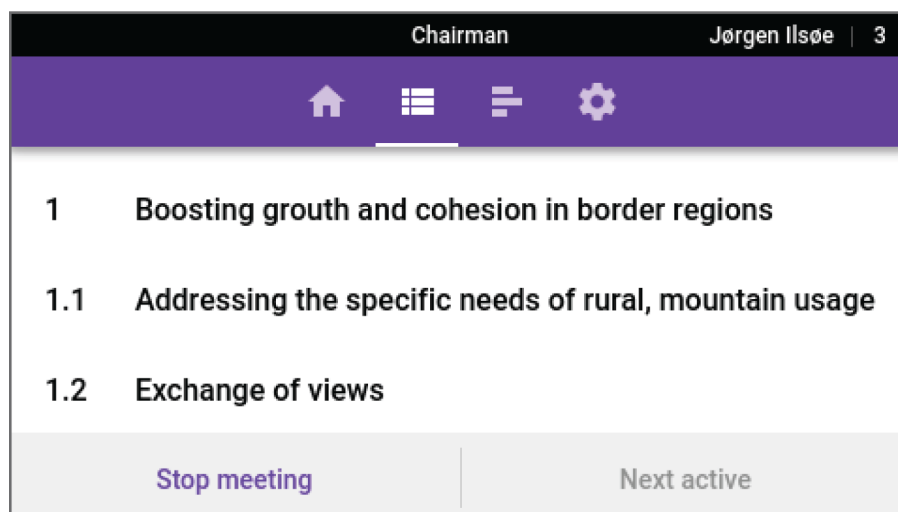

The Chairman can set an agenda subject active by selecting a subject, where a popup will appear showing the subject details. The popup will have the 'Set active' and 'Close' option.

If there is no active meeting, the Agenda screen allows the Chairman to select and start/stop an upcoming meeting.

## Voting/Result Menu

The Voting/result menu is always available for the Chairman, and displays the available voting options. In standalone mode, four options are available, while SW6000 enables all options (voting configurations) defined in SW6000.

The Voting/result menu is only available for delegates when a voting result is available.

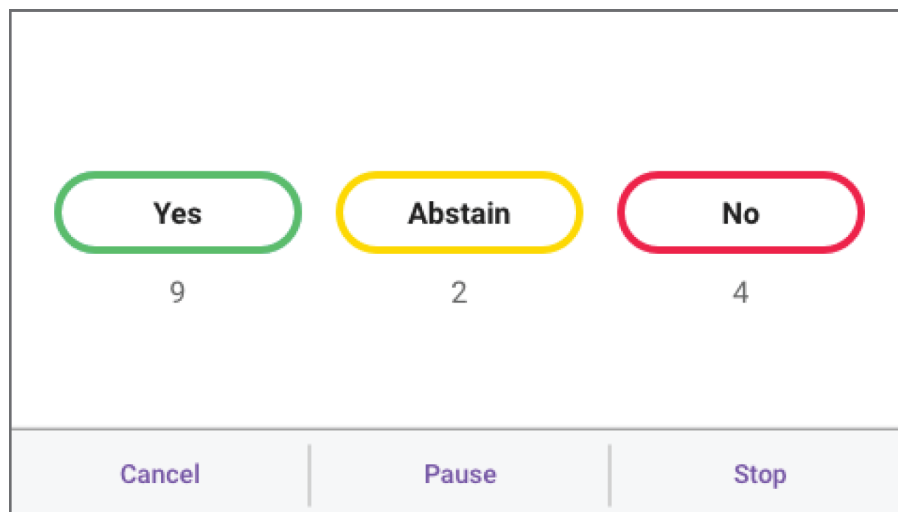
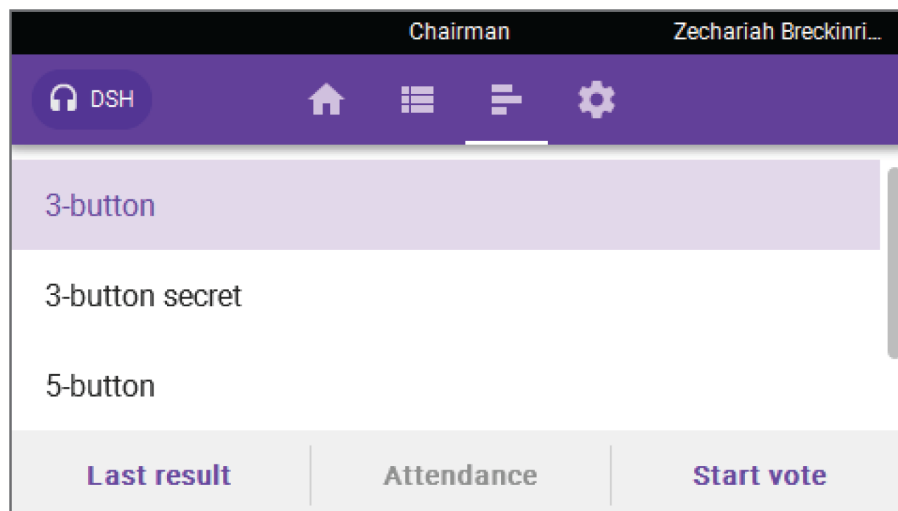

The screen for casting vote is automatically displayed on all conference units when a voting session or attendance check is started.

## Results

The Results pop-up is only shown when a vote or attendance check is completed. This is only shown after a vote is finished. Click *OK* to dismiss the

**Note:** Results are not available or displayed for cancelled voting sessions.

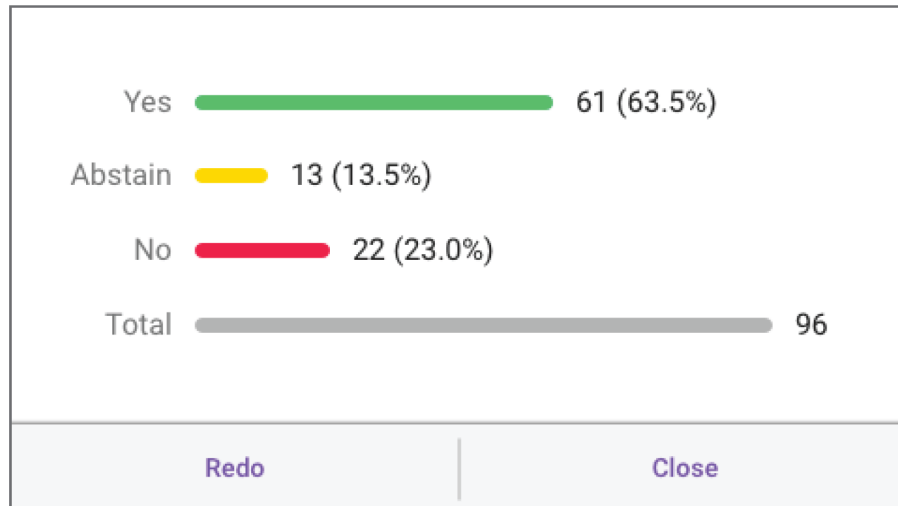
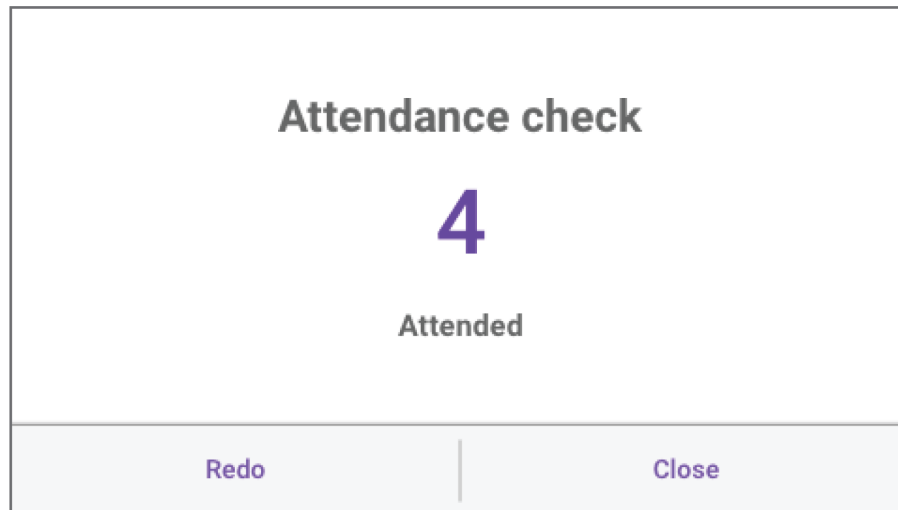

## Channel Selector

The Channel Selector allows the user to select from the available interpretation audio channels.



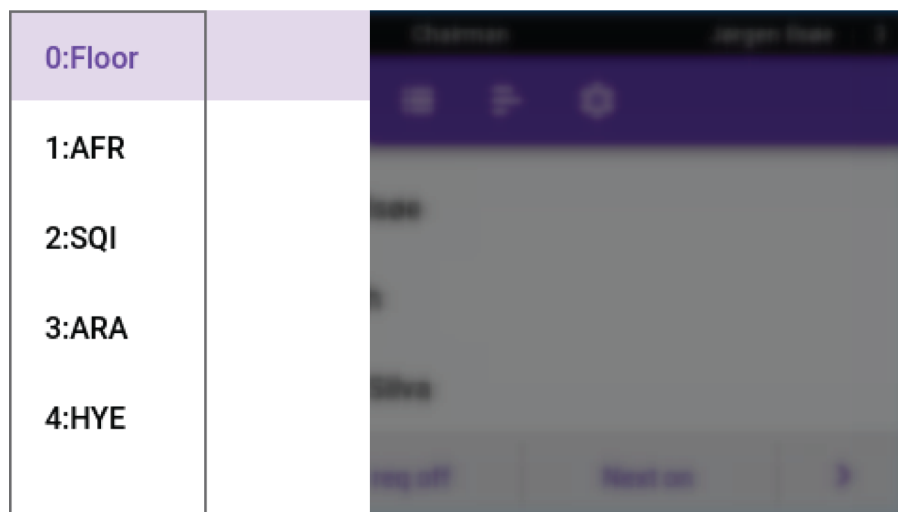

## Voting Functionality

Voting functionality can be controlled using an MXC640 conference unit in chairman mode, or through the SW6000 Parliamentary Voting software module.

In standalone mode, the CCU supports 2-, 3-, and 5-button voting configurations. Live results are available during voting sessions, unless the chairman has defined the session as 'Secret.' The CCU delivers final results at the end of voting sessions and attendance checks.

## User Controls & Indications

The units featuring voting functionality will include the following controls and interfaces.

+	Casts a 'Yes' vote, or declares the user as 'Present'
0	Records an 'Abstain' response
-	Casts a 'No' vote
+ +	Casts a '+ +' vote
- -	Casts a '- -' vote

The voting button LEDs indicate to participants which options are available. Attendance checks are indicated by the + LED.

Participants can cast or change votes for the duration of the voting session.

**Note:** In 'Secret' voting sessions, LEDs stop flashing after the vote is cast; however, votes can still be changed for the duration of the voting session.

## Audio Settings

### Microphone Functionality

When a microphone is turned on, the audio is routed to the main mix (Group A) and headphone output (Channel 0) by default. This mix is often referred to as the 'floor' mix, because it transmits the audio from the speaker to the rest of the participants in the meeting.

The number of allowed open microphones can be set at the CCU. The sound from all the open microphones is combined in the floor mix. The floor mix can be listened to on connected conference units and interpreter consoles, or sent to an external PA system.

## Route Microphones to Groups

By default, the floor mix is routed to the loudspeaker and headphone output (Channel 0) of each connected conference unit. Go to the Group Setup page (*Audio > Group Setup*) to view or modify the microphone routing.

The following routing options are available for each microphone (seat):

- Group A only (default)
- Group A + another group
- Group B, C, D, E, F, G, or H
- None

To change the audio source:

1. Route microphones to *Group A* to add them to the floor mix (selected by default): *Audio > Group Setup*

The screenshot shows the DIS-CCU 6000 System Setup web interface. The left sidebar contains a navigation menu with the following items: Microphone control, Meeting controls, Audio (selected), Loudspeaker control, Input control, Output control, Group setup, Ambient microphone, Devices, Interpretation, System, and Diagnostics. The main content area is titled "Group setup" and features a "Group setup" dialog box. The dialog box has "Seat range" set to 1 - 4 and "Groups" A, B, C, D, E, F, G, H. An "Apply" button is visible. Below the dialog box, the "Seat number" is set to 1. A table displays the microphone routing for seats 1 through 4 across groups A through H. The "Group A" column for all seats is checked, indicating that all microphones are routed to Group A. Below the table, the text "Group A = Floor" is displayed. The footer of the page includes the SHURE logo, "Copyright © 2018 www.shure.com", and "dis-ccu.local".

Seat number	Group A	Group B	Group C	Group D	Group E	Group F	Group G	Group H
1	<input checked="" type="checkbox"/>	<input type="checkbox"/>	<input type="checkbox"/>	<input type="checkbox"/>	<input type="checkbox"/>	<input type="checkbox"/>	<input type="checkbox"/>	<input type="checkbox"/>
2	<input checked="" type="checkbox"/>	<input type="checkbox"/>	<input type="checkbox"/>	<input type="checkbox"/>	<input type="checkbox"/>	<input type="checkbox"/>	<input type="checkbox"/>	<input type="checkbox"/>
3	<input checked="" type="checkbox"/>	<input type="checkbox"/>	<input type="checkbox"/>	<input type="checkbox"/>	<input type="checkbox"/>	<input type="checkbox"/>	<input type="checkbox"/>	<input type="checkbox"/>
4	<input checked="" type="checkbox"/>	<input type="checkbox"/>	<input type="checkbox"/>	<input type="checkbox"/>	<input type="checkbox"/>	<input type="checkbox"/>	<input type="checkbox"/>	<input type="checkbox"/>

2. Select the audio sources for the loudspeaker and Channel 0 (headphone): *Audio > Input Control*:
  - Floor (default)
  - Audio In 1
  - Audio In 2

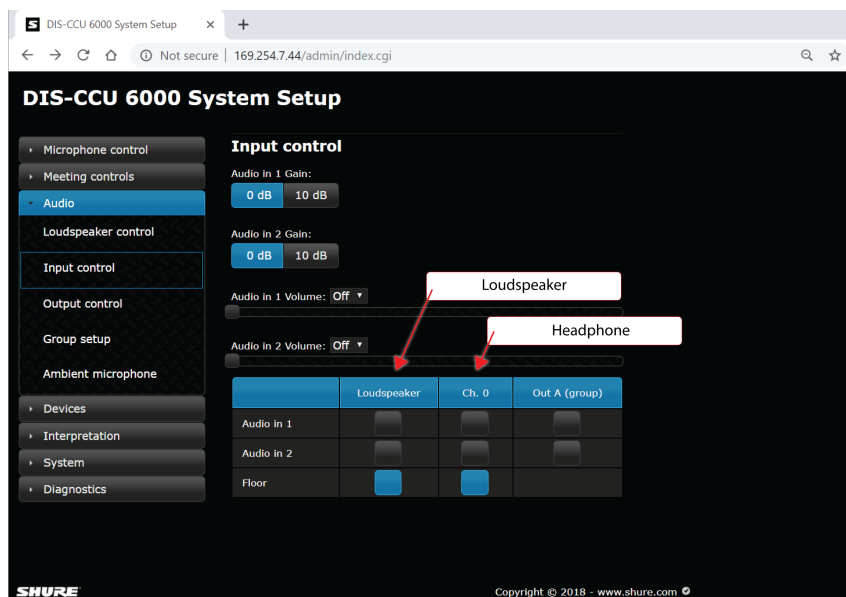

## Floor Mix on the Loudspeakers

Loudspeakers are included in most conference units for localized sound-reinforcement of the meeting. When a participant uses their microphone, their speech is heard in the loudspeakers of the other units in the system. This improves speech clarity in large rooms and reduces typical problems associated with sound reinforcement systems.

*Note: To avoid feedback, the loudspeaker in a unit is turned off when the microphone is active.*

## Loudspeaker Adjustment

Loudspeaker volume is a system setting that applies to all connected units. Volume is adjustable from -0 dB (no attenuation) to -40 dB, including off (mute). To adjust the volume:

<b>From the Browser Interface</b>	Go to the Loudspeaker Control page ( <i>Audio &gt; Loudspeaker Control</i> ) or the <i>Microphone control</i> screen
<b>From the CCU</b>	Scroll to the Loudspeaker Menu ( <i>loudspk. control &gt; loudspk. volume &gt; db</i> )

## Headphone Channels

Conference units include a headphone output for listening to interpreter channels or other participants on the floor channel. Each participant chooses their channel from the conference unit channel selectors.

Channels 1 - 31 are dedicated for language interpretation. Participants select one of the channels to listen to their language during a multilingual event. The audio source comes from interpreter stations transmitting onto their selected channel. See the Interpretation section of this guide for more details.

Channel 0 (the floor channel) is typically selected by interpreters to provide simultaneous interpretation of those addressing the floor, or by participants to listen to the floor channel on headphones.

1. Connect headphones to the headphone jack on the side of the conference unit.
2. Select a channel by pressing the channel selector button(s).
3. Adjust the volume of the headphones using the unit's volume controls.

## Analog Audio Outputs

Eight analog outputs are available for recording, language distribution system, teleconferencing unit, or an external PA system.

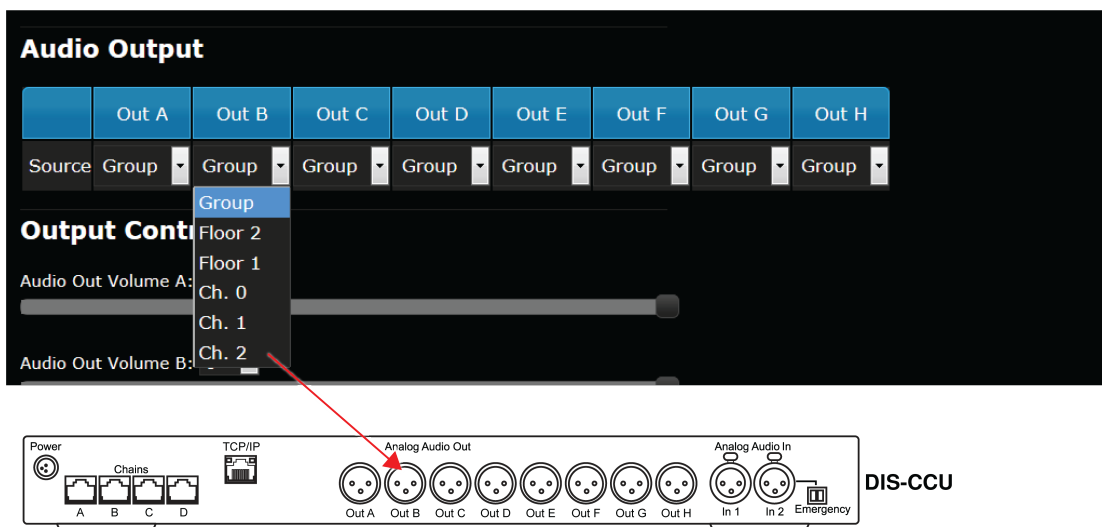

### Eight Analog Outputs

Select the audio source for each analog output

Go to *Audio > Output Control* and choose from the following options:

- **Group:** Eight separate groups for isolating specific microphones. This selection corresponds to the groups configured from the *Group Setup* page.
- **Ch. 1 -31:** Interpretation channels
- **Floor:** The audio from all open microphones that are routed to Group A (floor mix). There are three variations on this mix to choose from:
  - Ch. 0: Headphone mix with AGC, useful for sending to an IR language distribution system.
  - Floor 1: Loudspeaker mix, useful for sending to a PA or broadcast equipment.
  - Floor 2: Loudspeaker mix with volume attenuation (*Audio > Loudspeaker Control*)

## Adding an External Audio Source

Two inputs are available on the CCU for adding an external audio source to the system, often useful for teleconferencing or internet calling.

1. Connect a line-level audio source, such as the audio output of a computer, teleconferencing unit, or wireless microphone system to the audio input on the CCU back panel.
2. Open the web interface to *Audio > Input Control*.
3. Select the input gain according to the output of the external device. If necessary, select 10 dB for a slight gain boost.
4. Select the routing for the audio channel:
  - **Loudspeaker:** to all microphone unit loudspeakers
  - **Ch. 0:** to the headphone output on the microphone unit
5. If desired, route the channel to Output A (Group) to output a blend of the external source with the floor mix from the conference units:
  - **Deselect** for teleconferencing or signal processing to avoid a feedback loop
  - **Select** for a wireless microphone to be blended with other microphone unit audio
6. Adjust the volume at the audio source to mix naturally with speech levels of the conference units.

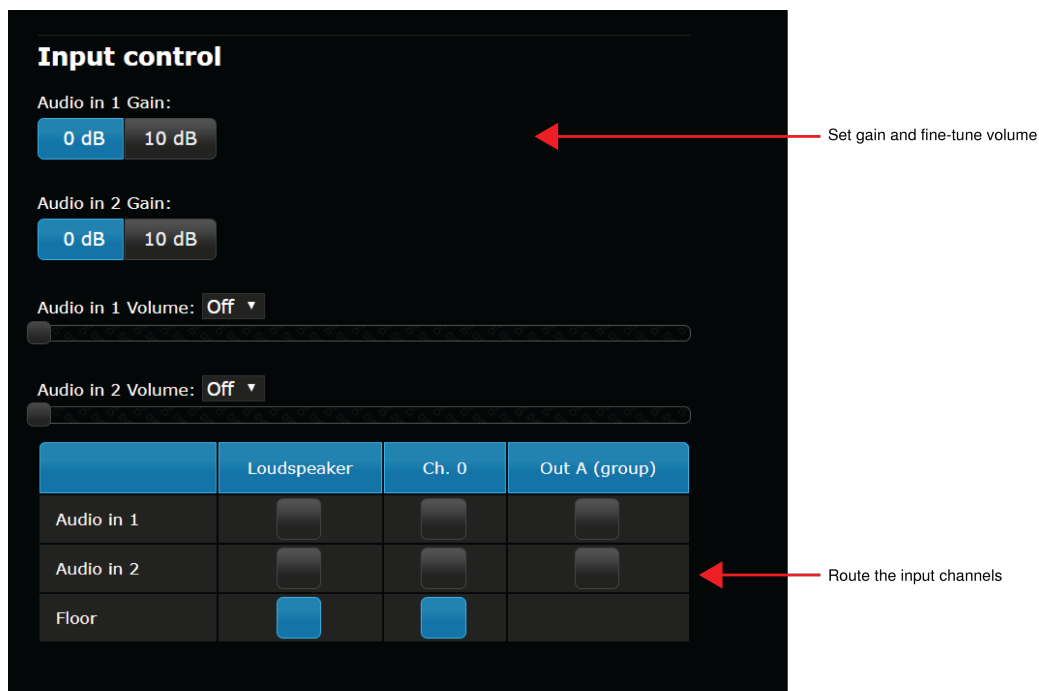

Input Control Page

Audio &gt; Input Control1

## Emergency Audio Signal

To prepare for an emergency, connect an Emergency Evacuation Message (EEM) audio signal to Input 2. The block connector provides a 'normally-open' switch that when closed, distributes the emergency signal to the loudspeakers and all input and output connections.

**Important:** When the switch is used for Input 2, the EEM audio signal bypasses the volume and on/off settings. Control the volume of the EEM signal at the source output.

1. Connect the EEM signal to Input 2.
2. Connect a switch to the block connector.
3. Close the switch and test the audio signal. Adjust the volume at the audio source to the desired level.

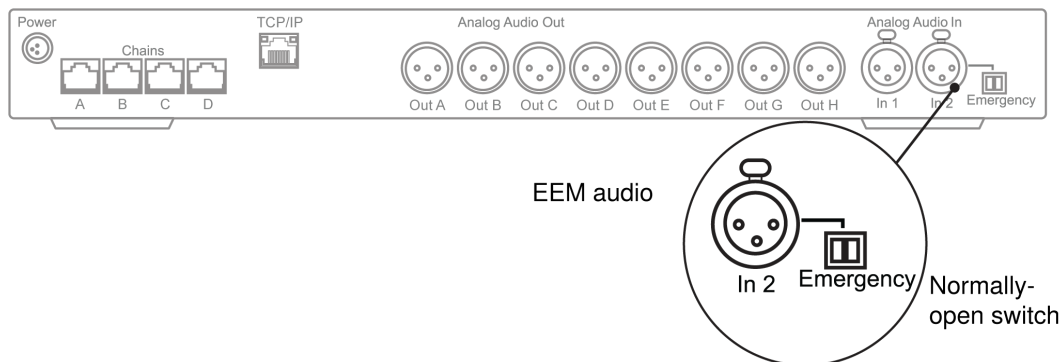

# Meeting Configuration

## Names, Roles and Seat Numbers

When a meeting begins, the chairman or moderator will need to refer to the participants by either name, seat number, or both. The proper assignment of names and seat numbers is critical to ensure the continuity of the meeting.

### Assigning Seat Numbers

Each conference unit is automatically assigned a seat number when the system is turned on for the first time, or when a new conference unit is connected. To update seat numbers according to a seating chart:

1. Go to *Devices > Device setup*.

**DIS-CCU 6000 System Setup**

Microphone control  
Meeting controls  
Audio  
Devices  
Device setup  
Participant setup  
Name sign setup  
Interpretation  
System  
Diagnostics

**Device setup**

Seat Number : 7

Serial number	Chain	Seat number	Model	Type	Audio in	Loudspeaker attenuation	State
006.004.237-B	B	7	MXC640-A				Active
005.218.181	A	12	MXC620-A	Single unit ▾		0 ▾	Active
005.219.056	A	15	MXC630-A	Single unit		0 ▾	Active
005.220.005	A	21	MXC620F-A	Single unit		0 ▾	Active
006.040.070	B	22	MXC630F-A	Single unit		0 ▾	Active
006.061.182	A	33	MXCMIU-B	Single unit ▾		0 ▾	Active
005.250.034	A		MXCIC-A	Interpreter			Active
006.055.005	A		MXCSIGN-A	Name sign			Active
006.066.188	B		MXCIC-A	Interpreter			Active
006.066.190	A		MXCIC-A	Interpreter			Active

Remove Unregistered Units

SHURE Copyright © 2019 - www.shure.com

2. Make sure all units are connected and functioning, indicated by the serial number and seat number in the list.

**Note:** Disconnected units can be removed from the list by selecting *Remove Unregistered Units*.

3. Reassign seat numbers to match the actual seat numbers in the room or on your seating chart.
4. Match the entries in the seat table to the corresponding units in the room by clicking in the seat number field. The light ring on the microphone flashes red to confirm your selection.
5. Type a new seat number, or use the up/down arrows to re-arrange the seats in the list. Entering a seat number used by another conference unit swaps the seat numbers between units.

The *Type* column refers to the unity type. If a conference unit is configurable as a dual unit, a dropdown is available to make the selection. Changing the unit type from single to dual restarts the conference unit. The original entry is removed and two new entries with new seat numbers are created when the page information refreshes.

### Assigning Names and Roles

MXC conference units can support Chairman or Delegate roles for meeting participants. Roles are set manually in the *Devices > Participant setup* menu:

## DIS-CCU 6000 System Setup

- Microphone control
- Meeting controls
- Audio
- Devices
- Device setup
- Participant setup
- Name sign setup
- Interpretation
- System
- Diagnostics

### Participant setup

Participant names ▼

Reset all names

Use card data

On  Off

Seat number:

Seat number	Participant name	Meeting role	Speak priority	Left button	Microphone attenuation
1	Seat 1	Chairman ▼	5	Mute all ▼	0 ▼
2	Seat 2	Delegate ▼	1 ▼	Mute ▼	0 ▼
4	Seat 4	Delegate ▼	1 ▼	Mute ▼	0 ▼
5	Seat 5	Delegate ▼	4 ▼	Mute ▼	0 ▼
6	Seat 6	Delegate ▼	1 ▼	Reply ▼	0 ▼
7	Seat 7	Delegate ▼	1 ▼	Reply	
12	Seat 12	Delegate ▼	1 ▼	Mute ▼	0 ▼
15	Seat 15	Delegate ▼	1 ▼	Mute ▼	0 ▼
21	Seat 21	Delegate ▼	1 ▼	Mute ▼	0 ▼
22	Seat 22	Delegate ▼	1 ▼	Mute ▼	0 ▼

SHURE Copyright © 2019 - www.shure.com

The default speak priority is 1. Chairman units have a speak priority of 5.

Setting the speak priority to 0 disables speaking privileges for the unit, while still allowing listening and voting, but the microphone can be turned on by a chairman.

The *Participant name* can also be modified on this screen. By default, this is populated with the seat number (Seat 1, Seat 2, etc.). Manually update the *Participant name* field for each seat, or click *Reset all names* to reset to the default values.

If *Use card data* is set to **On**, the MXC system pulls participant information from the NFC card, if applicable. When the card is removed, the information reverts to the values set in the web app.

## Meeting Controls

Several factors may affect the meeting requirements and the manner in which the meeting is run: room size, number of participants, formality of the event, and amount of technical support on staff. Adjust these settings in the CCU to best fit the meeting needs:

- **Speak mode:** how participants are allowed to address the floor
- **Reply functionality:** briefly comment to the current speaker without altering the request queue
- **Number of simultaneous speakers:** control the discourse by limiting the number of speakers at once
- **Microphone override (Interrupt mode):** behavior of the microphone activation when the speaker list is full

## Microphone Settings

**DIS-CCU 6000 System Setup**

Microphone control

Meeting controls

Microphone settings

Speak lists settings

Voice detection

Audio

Devices

Interpretation

System

Diagnostics

**Microphone settings**

Speak mode:

Auto

Auto + reply

Manual

Manual + reply

VOX

VOX + reply

FIFO

Speak interrupt ability:

Not allowed Lower Same or lower

Delegate speak button lock:

On Off

Lock override time: 2 Lock duration: 4

Allow mic off:

Allowed Not allowed

Mute button behavior:

Toggle Press and hold

**SHURE**

Copyright © 2019 - www.shure.com

## Speak Mode

The “Speak mode” determines the behavior of the microphone system.

- **Auto** (Automatic) mode allows for conference units to be immediately toggled on or off by pushing the *Speak* button.
- **Manual** mode features a Request list. The *Speak* button adds delegates to the request queue. Pushing the button a second time cancels the request.

*In Manual mode, the conference unit microphone can only be turned on remotely, either from the CCU web app, from SW6000, or from a third-party control system, but can be turned off using the Speak button.*

- **FIFO** (First In, First Out) is an automated mode featuring both immediate activation and a Request list. A meeting administrator sets a maximum number of speakers and requests. Pushing the *Speak* button activates the delegate's microphone immediately, until the maximum number of delegate speakers is reached, at which point delegates are placed in the request queue until the maximum requests is reached.



When an active unit is switched off, the first unit in the queue turns on automatically. The Request indicator flashes when the conference unit is at the top of the queue and is the next to be switched on.

- **VOX** (voice activation) mode allows conference units to be switched on automatically when a delegate is speaking in the microphone, as well as toggled on or off using the *Speak* button. The microphone also turns off automatically after 4 seconds.

Dual units do not support VOX. If VOX is selected, a dual unit will operate in Auto mode. Chairman units are always in Auto or VOX mode.

**Note:** VOX is available in legacy DCS units, and support for MXC is planned for a future firmware update.

## Speak Interrupt Ability

The *Speak interrupt ability* setting determines when a participant can interrupt (turn off) other active speakers by turning on their own microphone, if the number of active microphones reaches the limits set under *Max. speakers: Delegates* and *Max. speakers: Total*.

- **Not allowed:** When the number of open delegate microphones reaches the *Max. speakers: Delegates* limit, or the number of open chairman microphones reaches the *Max. speakers: Total* limit, no more delegate/chairman microphones can be opened and the green LED will flash 3 times.

**Note:** When the *Max. speakers: Delegates* limit is met but the *Max. speakers: Total* limit is not, a chairman can interrupt the first delegate added to the *Speak list*.

- **Lower:** When the *Max. speakers: Delegates* limit is reached, a speaker interrupts the first delegate added to the *Speak list* with lower priority.
- **Same or lower:** Any participant can interrupt the first delegate added to the *Speak list* with the same or lower priority when the *Max. speakers* limit is reached. If only chairman microphones are active, a chairman can interrupt the first chairman added to the *Speak list*.

Individual priority settings can be manually determined in the *Speak priority* column under *Devices > Participant setup*.

## Speak Button Lock

When controlling microphones remotely, the *Speak* button can be temporarily disabled to avoid unintentional activation by the delegate.

*Speak button lock* is *Off* by default. When turned *On*, only units/users with speak priority 0-4 are locked. Remote commands from TCP/IP, SW6000, and units with microphone control permission are not affected.

**Lock duration** is the amount of time the button's toggle functionality is affected.

- Ranges from 2 to 120 seconds, in 1-second intervals
- After this time, functionality returns to normal

**Lock override time** is the amount of time (in seconds) that the *Speak* button must be held for the speaker to bypass the lock.

- Ranges from 1 to 120 seconds, in 1-second intervals
- Can never be longer than the Lock duration time

## Allow Mic Off

This determines whether a delegate can turn his or her microphone off. The option defaults to *Allowed*.

When set to *Not allowed*, only a participant with microphone control permission (Chairman) can turn off the microphone.

The setting is available in the Auto, Auto + Reply, Manual and Manual + Reply modes, and only applies to units/users with speak priority 0-4.

## Mute Button Behavior

- **Toggle:** Pushing the *Mute* button on a conference unit mutes the microphone. Pushing the button again un-mutes the microphone.
- **Press and hold:** Pushing the *Mute* button mutes the microphone. Releasing the button un-mutes the microphone.

## Reply Functionality

The reply mode enables participants to briefly comment or ask a question to the present speaker. This allows a concise follow-up to the speaker without affecting the request queue.

On the participant's conference unit, the left (function) button can be programmed to operate as a Reply button. MXC640 conference units can also have the Reply button assigned to the touchscreen. The participant presses the Reply button to add themselves to the Reply list (shown above the Request list), and the chairman or operator manually activates the reply. Participants on the Request list can be added to the Reply list, but participants on the Speak list cannot.

The Reply option is available in Manual, Automatic and VOX modes. In Manual mode, the reply list is cleared when the next request is turned on.

Replies are sorted by the order in which they are received. If multiple reply options are used, replies are sorted by priority. A participant is removed from Reply list when their microphone is turned on.

## Speak List Settings

To improve speaker management and clarity of the audio, there is a limit to the number of speakers at the same time. The number of active microphones is adjustable from 1 - 8. Once the limit is reached, a participant trying to turn on the microphone may be added to a request queue or denied access, depending on the microphone operating mode.

Go to *Meeting controls > Speak list settings* to define the following parameters:

**Note:** *Interpreter consoles are not impacted by speak list settings.*

<b>Max speakers</b>	<ul style="list-style-type: none"> <li>• <b>Total:</b> The maximum number of participants who can speak at the same time. This includes both delegate and chairman units. Limit: 8</li> <li>• <b>Delegate:</b> The maximum number of delegates allowed to speak at the same time. (Chairman units can always be switched On as long as the number set in 'Max. speakers: Total' is not exceeded.)</li> </ul>
<b>Max Requests</b>	Maximum number of speakers that can be placed in the Request list. Limit: 250
<b>Max Replies</b>	Maximum number of speakers that can be placed in the Reply list. Limit: 250

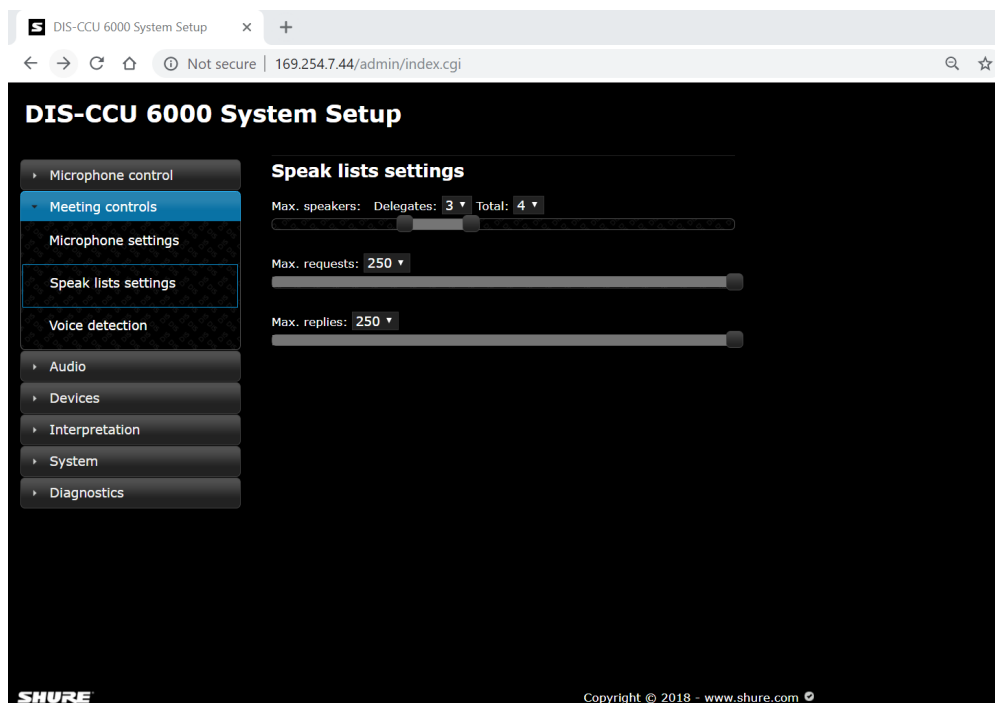

## Example Settings

Chairman (Moderator) Can Speak At Any Time Without Interrupting

Set the *Max. speakers: Total* limit one (1) higher than *Max. speakers: Delegates*.

Using FIFO Mode

First In, First Out (FIFO) mode automatically turns on microphones based on a chronological queue list. This mode works best if *Max. speakers: Delegates* is set to one (1), so that the delegate must wait to speak until the other is finished.

## Voice Detection

Adjust voice detection settings from *Meeting controls > Voice detection*.

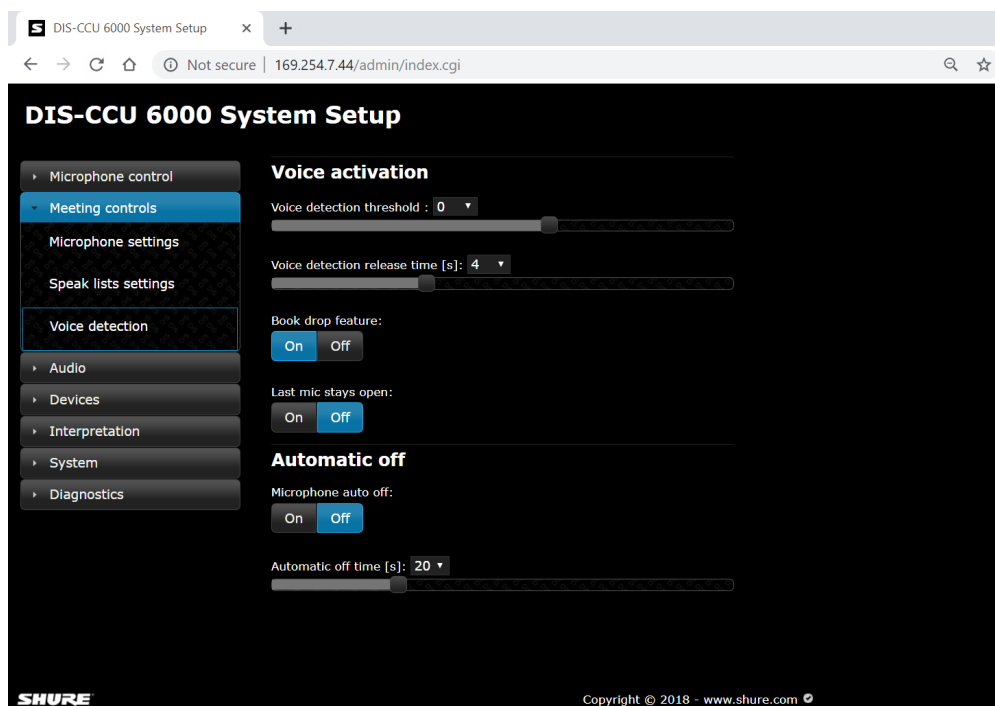

## Voice Activation (VOX)

In VOX mode, the microphone activates automatically once a participant speaks. The mode is ideal for meetings that are more conversational, allowing back-and-forth communication that doesn't involve speak requests and button activation. The following settings allow VOX to be customized for the meeting:

<b>Voice Detection Threshold</b>	Determines the input level (dB) that activates the microphone. Lower settings activate the microphone with a quieter source, while higher settings require a louder source to activate the microphone.	
	<b>Default</b>	0 dB
	<b>Minimum</b>	-12 dB
	<b>Maximum</b>	8 dB
<b>Release Time</b>	Determines how long a microphone remains active after a participant stops talking. The setting is selectable in 0.5 second increments.	
	<b>Default</b>	4 seconds
	<b>Minimum</b>	1 seconds
	<b>Maximum</b>	10 seconds
<b>Book Drop</b>	To ensure that only the speech from a participant activates the microphone, turn on the book drop feature. This quickly turns off a microphone that has been accidentally activated from a loud noise other than speech.	
<b>Last Mic Stays Open</b>	This setting ensures that at least one microphone is always activated. This is useful for video or audio conferences with echo-canceling equipment.	

## Microphone Auto Off

This setting automatically turns off the microphone when the participant stops talking. This setting applies to systems in FIFO, Manual or Automatic modes. See *Meeting controls > Voice detection* to adjust the release time for that mode.

- Off (default)
- On

<b>Automatic Off Time</b>	The time for a microphone to turn off after the participant stops speaking.	
	<b>Default</b>	20 seconds
	<b>Minimum</b>	5 seconds
	<b>Maximum</b>	60 seconds

# Security

MXC components use a proprietary codec algorithm to prevent unauthorized devices from listening to the audio signal. To further protect the meeting, assign a password to the browser interface and enable security features on wireless routers.

## Password Protect the Browser Interface

You can assign a password to restrict access to the browser interface. An independent password is assignable to each of the three interface addresses: administrator, chairman, and display.

1. Sign into the browser interface as an administrator.
2. Go to the Security page (*System > Security*)
3. Enter a password.
4. Select Change Password to save the login information.

**Note:** passwords are cleared when the unit is factory reset from the CCU hardware.

The screenshot displays the 'DIS-CCU 6000 System Setup' web interface. On the left is a navigation menu with the following items: Microphone control, Meeting controls, Audio, Devices, Interpretation, System (highlighted in blue), Device count, License, LAN setup, Security (highlighted with a red border), Language, Factory defaults & backup, and Diagnostics. The main content area is divided into three sections for password configuration:

- Admin login:** URL: 172.28.36.21/admin. Admin username: admin. Admin password: [input field]. Change password button.
- Chairman login:** URL: 172.28.36.21/chairman. Chairman username: chairman. Chairman password: [input field]. Change password button.
- Display login:** URL: 172.28.36.21/display. Display username: display. Display password: [input field]. Change password button.

## Language Interpretation

Up to 31 channels are available for simultaneous interpretation of the meeting. The MXCIC interpretation unit connects to the DCS-LAN network from the CCU, transmitting audio to independent language channels. Participants listen to their language on headphones connected to their respective conference unit. See the MXCIC User Guide for more information.

Four languages are provided with the FL6000 mode license, and can be expanded to 8, 16, or 31 with an additional license.

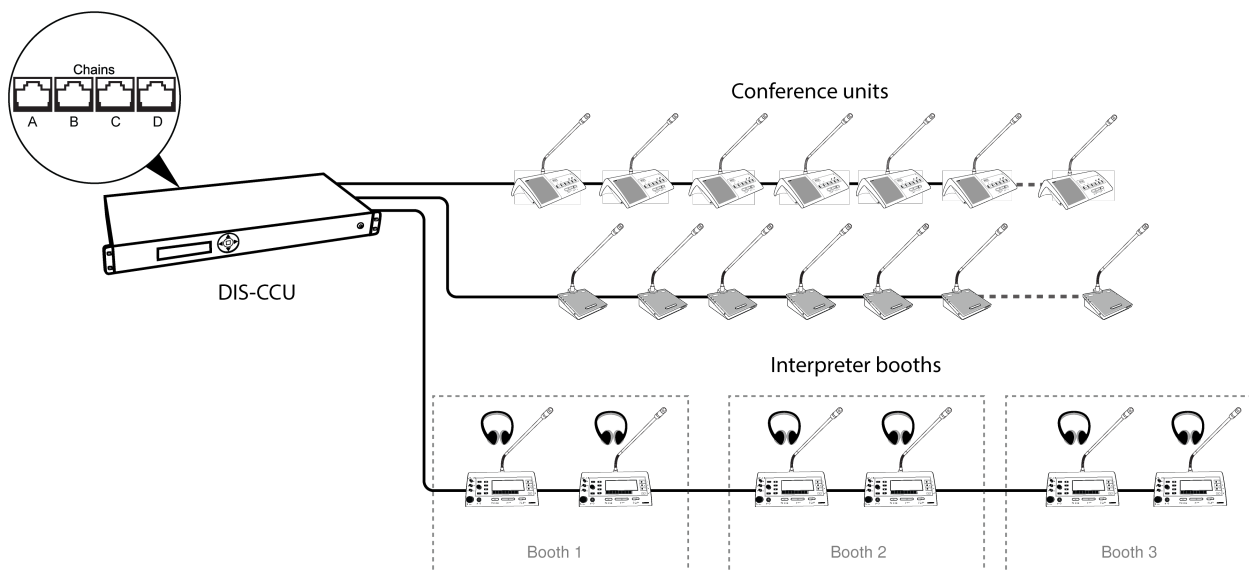

## Interpretation Setup

Multi-language interpretation can be set up through the CCU web interface in standalone systems, or in SW6000. If more than 4 languages are needed, purchase and install an additional feature license before setting up interpretation.

### Interpretation Channels

Assign the number of interpretation channels needed (0 to 31) at *Interpretation > Interpretation channels*.

**Note:** When 0 is selected, only Floor audio (Channel 0) is available.

The *Channel display* setting determines whether the channel selectors on participant conference units display channel number or language abbreviation.

### Language Setup

The *Language setup* list shows the channels defined in the *Interpreter channels* settings. Assign a language from the drop-down menu for each language.

### Booth Channel Setup

To simplify managing multiple languages, interpreter consoles are grouped into Booths.

By default, Booth 1 is assigned to Channel 1, Booth 2 to Channel 2 etc., but languages can be manually assigned to booths at *Interpretation > Booth channel setup*. Multiple booths can be assigned to the same interpretation channel.

## Interpretation Settings

### Mic Interrupt Modes

The *Interpretation > Mic interrupt modes* setting applies when there are multiple interpreters on the same language. By default, interpreters alternate with each other and cannot override a unit already in use.

	<p><b>Note:</b> The primary (A) language corresponds to the booth language. Interpreters select their B and C languages from the MXCIC.</p> <ul style="list-style-type: none"> <li>• <b>Interruption allowed:</b> Interpreters can turn on their microphone at any time, taking over from the present interpreter. This applies to any interpreter with any setting</li> <li>• <b>A Interrupt A:</b> An interpreter turning on the A channel interrupts another interpreter's A channel.</li> <li>• <b>A Interrupt B+C:</b> An interpreter's A channel interrupts another interpreter's B or C channel, but not another interpreter's A channel.</li> <li>• <b>A Interrupt A+B+C:</b> An interpreter's A channel interrupts another interpreter, regardless of channel.</li> <li>• <b>Interruption not allowed (default):</b> When a channel is in use, another interpreter cannot turn on their microphone</li> </ul>
<b>Auto Floor</b>	<p>By default, interpretation channels with no active interpretation have the floor mix. To change the setting, go to <i>Interpretation &gt; Auto floor</i>.</p> <ul style="list-style-type: none"> <li>• <b>On:</b> Language channels with no interpretation have the floor mix</li> <li>• <b>Off:</b> Language channels with no interpretation have no audio</li> </ul>
<b>Channel Display</b>	<p>Choose the way the interpretation channel is displayed on the conference unit: <i>Interpretation &gt; Interpretation channels &gt; Channel display</i></p> <ul style="list-style-type: none"> <li>• <b>Number:</b> Channel number</li> <li>• <b>Abbreviation:</b> First three letters of the language name in English</li> </ul>

## Wireless Language Distribution

Provide additional monitoring access by connecting a wireless language distribution system to the one of the CCU audio outputs. Use the browser interface to route the desired interpretation channels or a subset of microphones to that group output.

The DIR Digital Infrared Language System transmits this audio signal to a number of portable listening devices.

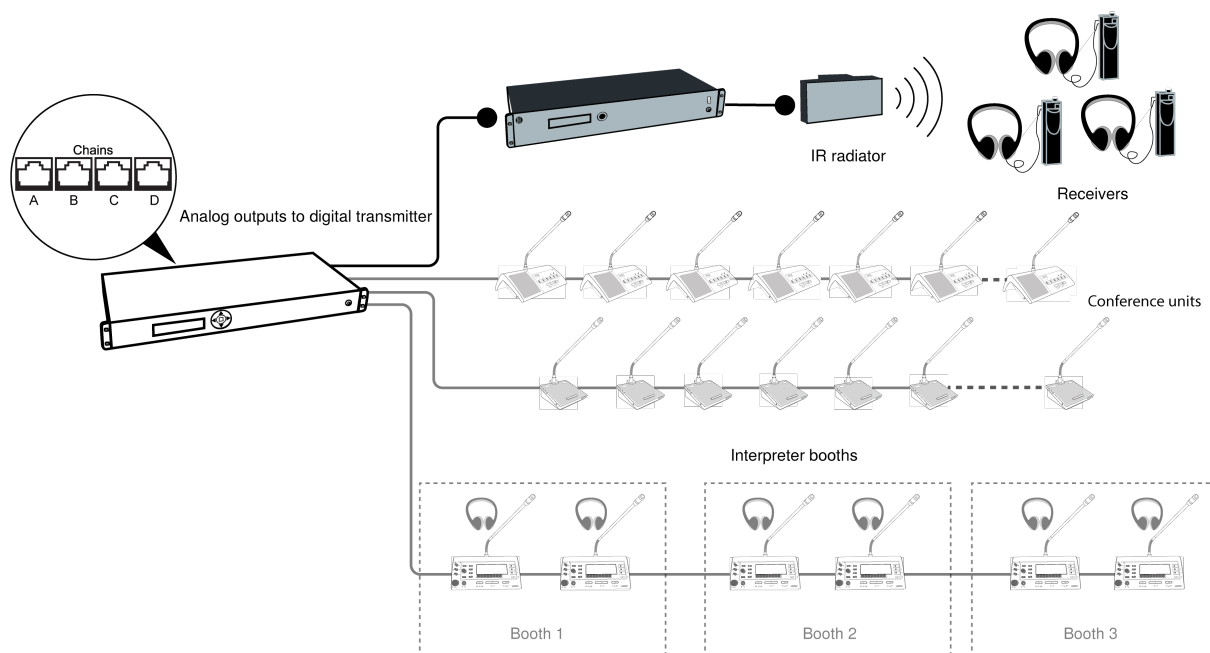

**Wireless Language Distribution**

## Listening to Interpretation

Follow these steps to listen to one of the interpretation channels:

1. Connect headphones to the headphone jack on the conference unit.
2. Select a channel by pressing the selector buttons on the front of the unit.

**Tip:** When no channel is selected, the *Auto Floor* option in the *Settings* menu automatically switches to floor audio.

3. Adjust the audio level of the headphones using the volume buttons.

## Firmware Update

The MXC Firmware Update Utility (FUU) is bundled with the firmware download on the Shure website. Use this program to keep your system updated to the latest firmware version, or to upload image files to compatible conference units. See the FUU help file for more.

1. Make sure the system is on and operating properly.
2. Download the latest firmware from the Shure website and extract the contents to your computer.
3. Open the MXC Firmware Upgrade Utility folder and launch the application.
4. Assign the connection method for the computer and equipment and select the *OK* button to exit the setup window:
  - **Ethernet:** Type the IP address of the CCU and use IP port 3142.
5. Information about the CCU and all connected units display in the main window.
6. Select the desired firmware release (typically the highest/latest) in the *Selected Release Id* drop-down list.
7. Select the *Upgrade System* button to begin the firmware update process. A status window will appear and show the progress of the firmware upgrade.



## Rackmounting the CCU

Install the central control unit in a standard 19" rack using the supplied 19" brackets. Remove the screws holding the top and bottom covers, then attach the brackets to the front of the unit using the same screws.

**Important:** Use the two 10 mm length self-threading screws closest to the front and the 8 mm length threaded screw furthest from the front.

The built-in fan draws air in on the left side and exhausts air on the right, and so does not require extra space above or below for cooling.

## Installing the Conference Units

To accommodate numerous variables in each installation, the MXC series provides several models of conference unit in both tabletop and flush configurations.

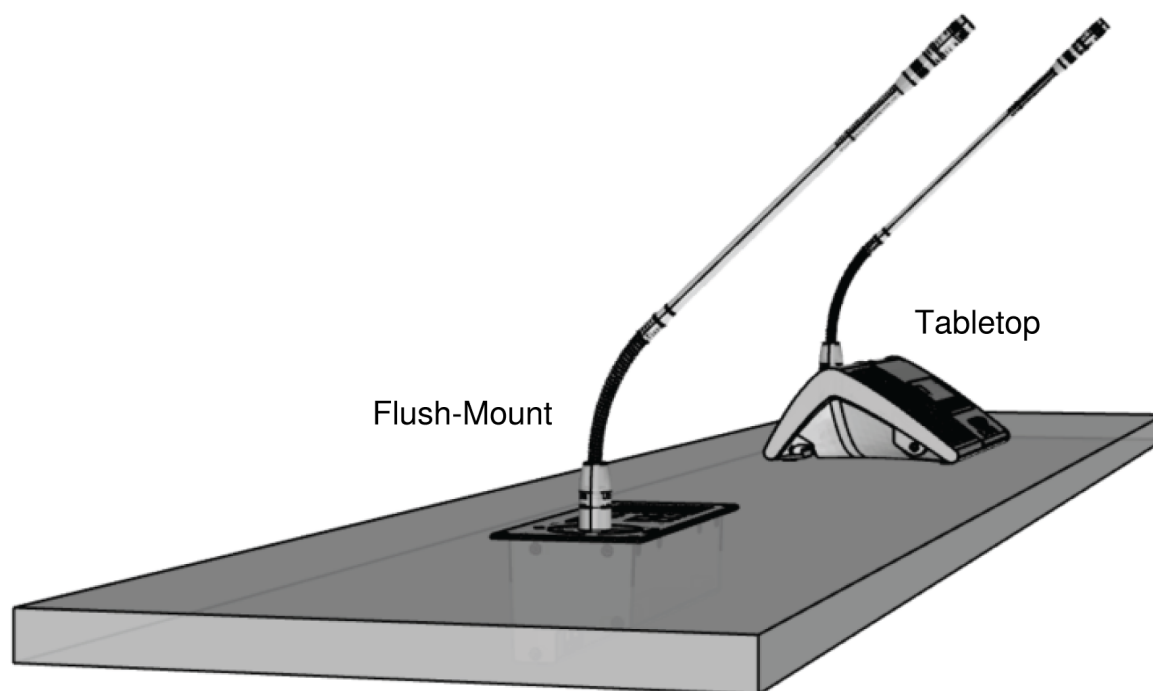

### Installation options

*Both models include the same features, but are useful for different environments and applications.*

<b>Tabletop (Portable)</b>	<ul style="list-style-type: none"> <li>• No modification required to table surface</li> <li>• Easily add or remove units</li> <li>• Can be fixed to tabletop using size 4 screws</li> </ul>
----------------------------	---

<b>Flush-Mount (Installed)</b>	<ul style="list-style-type: none"> <li>• Smaller footprint on table</li> <li>• Clean, professional look</li> <li>• No visible cables</li> </ul>
--------------------------------	---

Consider the following variables when making a decision on which type of MXC conference unit to purchase:

- Permanence: Is this a temporary or permanent installation?
- Cabling: Is your furniture historic or costly to modify?

## Connecting DCS-LAN Equipment

Shure offers cables designed specifically for the MXC line of conferencing and discussion equipment. The Shure EC 6001 cables are high-quality Ethernet cables available in various lengths from 0.5 m to 100 m. Each cable has been tested to ensure reliable system performance. See the accessories section for ordering information on the EC 6001-xx.

**Important:** Shielded Cat5e (or higher) cables required for reliable system performance.

### Cable Requirements

<b>Type</b>	Cat5e (or higher) twisted pair, F/UTP or U/FTP, minimum wire square: AWG 24
<b>Connector</b>	Shielded RJ45, EIA 568-B wiring
<b>Cable length</b>	<ol style="list-style-type: none"> <li>1. Max. 200 m from the CCU/EX/RP to the first MXC conference unit</li> <li>2. Max. 100 m between MXC units</li> <li>3. Max. 200 m between a CCU and a EX/RP and between EX/RP's</li> <li>4. Max. 1000 m equivalent cable distance from the CCU to the last unit <ol style="list-style-type: none"> <li>1. Each MXC unit represent an equivalent cable distance of 15 m</li> <li>2. Each EX/RP unit represent an equivalent cable distance of 100 m</li> <li>3. The longest feeding cable shall be used in the equivalent cable length calculation with redundant cabling</li> </ol> </li> <li>5. No MXC units between cascaded EX/RP units, or between CCU and EX/RP units</li> <li>6. Max. 3 cascaded EX/RP units</li> </ol>

**Important:** Cables and connectors must be shielded for stable system performance. If an installation does not use Shure EC 6001 cables, they must follow the Cat5e cable requirements.

### Using Patch Panels

When designing a system with a patch panel, crimp the cable to the female shielded connector on the panel. Then simply use short jumper cables to connect to the conference units.

### Continuity of Shielding

Shielding must be consistent through the DCS-LAN chain. Any cable or patch panel used for MXC components requires shielded RJ45 connectors. All MXC components feature shielded RJ45 female connectors.

## Avoiding Accidental Grounding (Galvanic Isolation)

Avoid accidentally grounding the DCS-LAN signal by isolating front-plates, conference units and DCS-LAN connections in wall-panels from the building ground. The DCS-LAN uses the shield as a signal ground reference and cannot contact another ground anywhere in the connection.

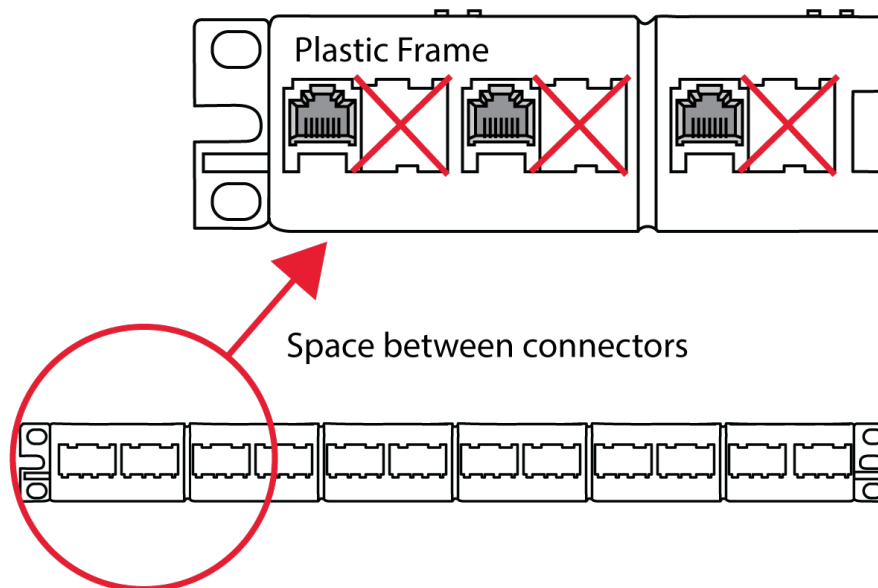

**Avoid Grounding in a Patch Panel**

To avoid ground issues:

- **Plastic frames in patch panel:** this ensures that the female RJ45 connectors do not ground to the chassis of the patch panel.
- **Blank space between connectors:** leave a space between each female RJ45 connector in a patch panel.
- **Shielding continuity:** each component in the chain must be shielded properly.

*Note: The female connectors in all MXC components units feature an air gap that isolates the chassis of the connector and the chassis of the unit preventing any galvanic (physical and thus electrical) connection.*

## Properly Securing Cables

As with any cable carrying a signal, use care when installing the equipment.

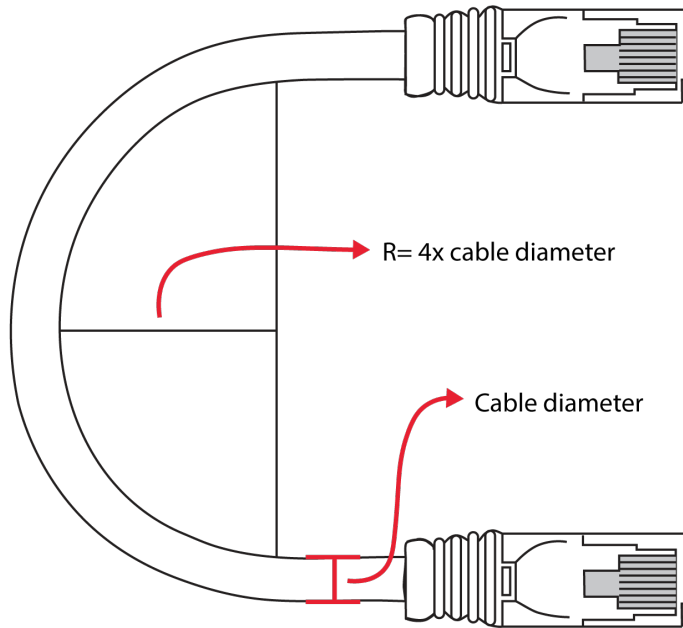

**Bending Rule**

*Do not sharply bend the cable. Ethernet cables cannot bend more than four-times the diameter of the cable.*

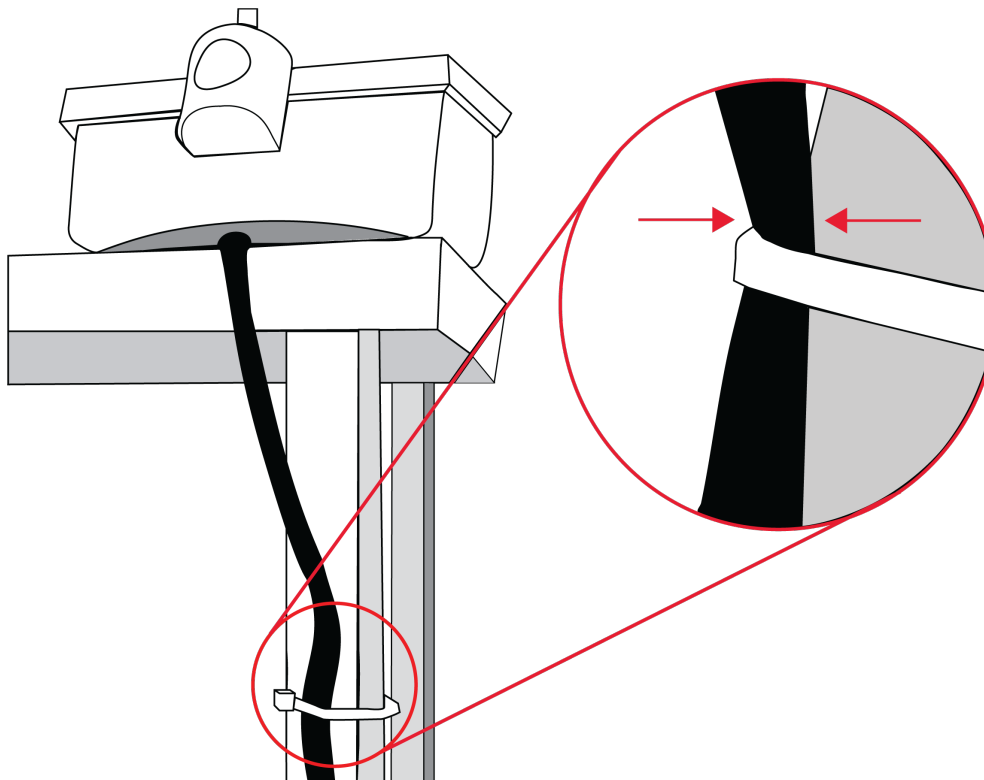

**Pinching**

*Do not over-fasten the cable. A pinched cable may not operate correctly.*

## Installing Large Systems

### DCS-LAN Power Calculator

For many installations, the CCU supplies sufficient power for the conference units. The CCU can power multiple units at a time without additional equipment. The number of supported conference units depends on the size and layout of the installation.

To determine the specific requirements for your installation, use the DCS-LAN Power Calculator at <https://dcslan.shure.com>.

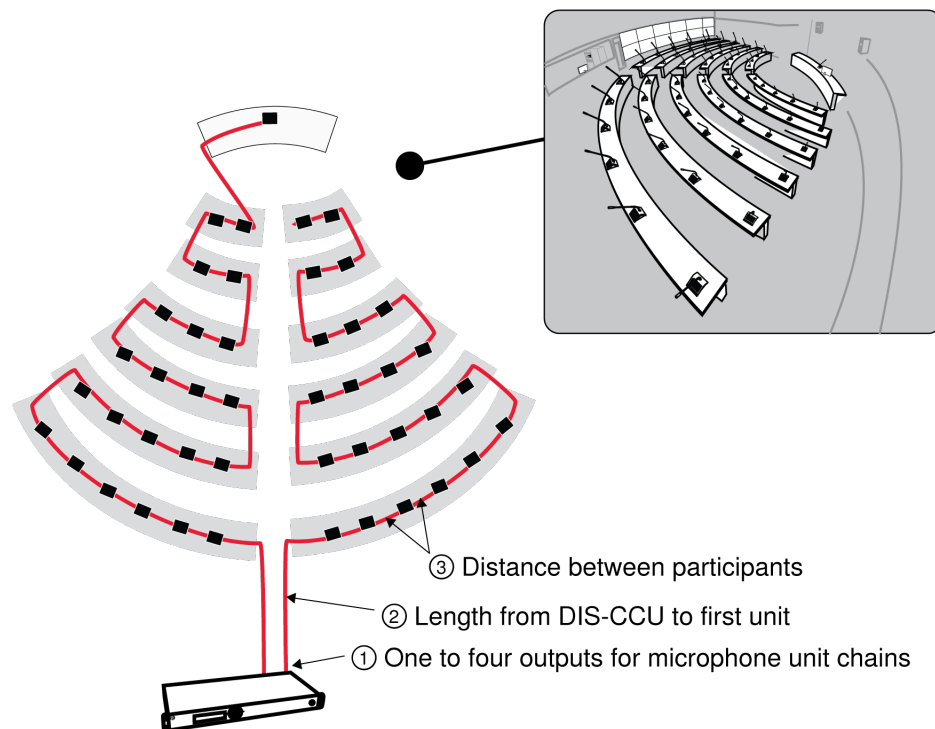

#### Power Depends on Installation Variables

To maximize the unit count without adding equipment:

1. Use multiple chain outputs from the CCU. Units should be divided evenly across each chain
2. Position the CCU so that the distance to the first microphone unit is as short as possible
3. Keep the total cable length as short as possible

### Power Supplies for Additional Components

To add additional components to the system, add an inline or rackmount power supply to the DCS-LAN chain. Multiple power supplies can be used to reach the maximum 3,800 supported units.

**Note:** To exceed 250 units, make sure the FL6000-3800 license has been purchased and installed in the CCU.

### Inline Power Supply

Use the PI-6000 power inserter to add an inline power supply for additional conference units. The unit may be connected at any point in the chain to power the additional components.

**Note:** The PI-6000 cannot be used in systems with redundant cabling, and does not refresh the data signal.

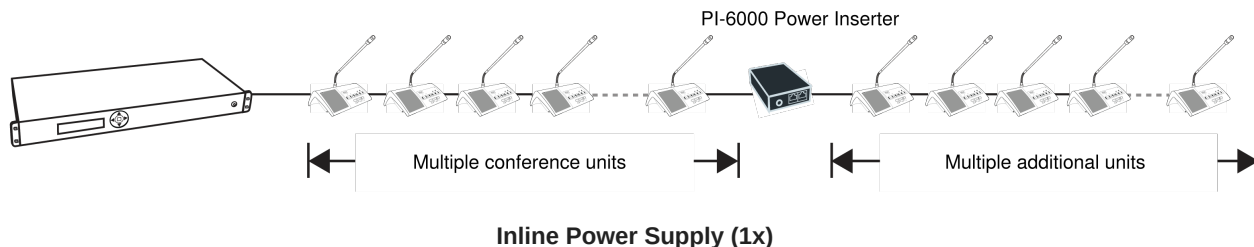

**Inline Power Supply (1x)**

## Rackmount Power Supply for 4 Additional Chains

Use the EX6010 rackmount extension unit to add additional components and configuration options. The unit expands the DCS chain into 4 separate outputs, each with a power supply equivalent of a CCU.

**Note:** Cable redundancy in can be achieved using the EX6010 by connecting the DCS-LAN OUT port of the last conference unit to an MXC Redundancy Interface Box (MXC-ACC-RIB), and looping back to a DCS-LAN port on the same EX6010.

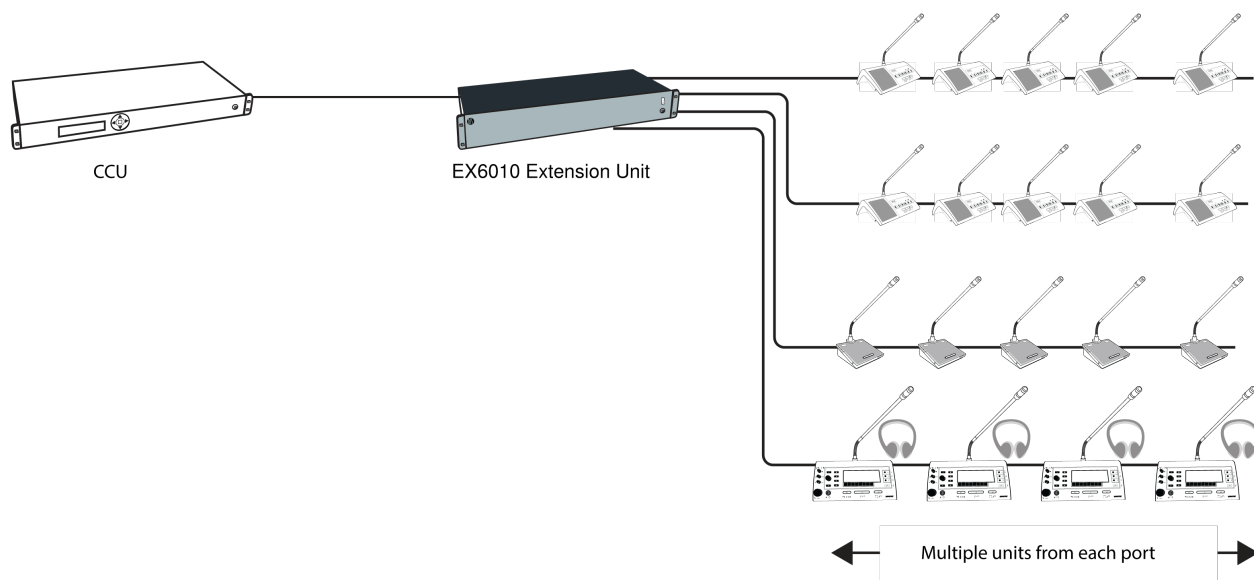

**Rackmount Power Supply (x4)**

## Troubleshooting

**Attention:** Always use shielded Cat 5e (or higher) network cables for reliable system operation. Ensure the right cables are used and installed correctly before referencing the troubleshooting table.

<p><b>The light rings on the microphone are constantly flashing after the system is powered on.</b></p>	<p>Check that cables are shielded Cat 5e (or higher)                  Ensure that all the connectors on all the cables are firmly inserted in the sockets on the units                  Check that the feeding cables from the conference units are properly inserted into the 'DCS-LAN' socket on the DIS-CCU.</p>
---	---

<p><b>The Function button on the Chairman Unit does not switch off the Delegate Units</b></p>	<p>Check to make sure the unit is configured as Chairman and that the function button is configured as <i>All del off</i></p>
<p><b>The audio from an Interpreter Unit cannot be heard in the headphone of Delegate or Chairman Units</b></p>	<p>Check the headphone volume control on the units  Check the channel selection on the conference units  Check that the headphone plug is firmly inserted in the headphone jack  Check that the light ring on the microphone on the interpreter console is illuminated and that the gooseneck microphone is firmly inserted in the socket</p>
<p><b>There is no audio coming from the built-in loudspeakers</b></p>	<p>Check the 'Loudspeaker Volume' setting using either the interactive menu on the CCU or using the browser control.  Check that the loudspeaker is set to sufficient volume. (<i>DIS-CCU browser &gt; Audio &gt; Loudspeaker Control.</i>)  Check that the floor mix is assigned to loudspeaker (<i>DIS-CCU browser &gt; Audio &gt; Input Control &gt; Loudspeaker</i>)  Check that the seats are selected in 'Group A' (<i>DIS-CCU browser &gt; Audio &gt; Group Setup</i>). 'Group A' is always used as the source for the floor mix. If a unit is not selected in 'Group A', the audio from the unit will not be heard in the built-in loudspeakers.</p>
<p><b>A microphone cannot be turned 'On'</b></p>	<p>Check the cables. All cabling must be Cat 5e or higher with shielded RJ45 cables.  Check the settings <i>Max. Delegate Speaker</i> and <i>Max. Total Speakers</i> to make sure there is room for another microphone to turn on.  Check the <i>Speak Mode</i> to make sure the mode allows participants to turn on their own microphones.</p>
<p><b>The CCU browser application will not open on a PC</b></p>	<p>Using the interactive menu on the CCU, check the IP address: <i>LAN setup &gt; Acquire IP address</i>. Use this IP address using the browser  Verify that the CCU and the PC are connected to the same network  Check the LAN cable connections  Verify that the tablet or laptop is connected to a proper wireless access point    Check that the CCU is connected to the same subnet as the wireless access point</p>

## Diagnostics

To assist in troubleshooting, network topology and system-wide diagnostic information is available. You can also generate detailed reports for advanced troubleshooting.

### System Diagnostic

The following is available under *Diagnostics > System diagnostic*:

- **Event Log:** View system activity and alerts, including network mapping, cable breaks, disconnections and power issues.

- **Network:** Save the current reference network to enable network mapping and topology reports. This option is available when all units are registered and the network is fully analyzed.
- **Indication:** Click *Indication in all devices* to activate the LEDs in all connected units, to visually check that all units are connected and working. Click *Indication in selected DCS-LAN connection* to view the units in a specific chain or loop, and identify the first and last units in the sequence.

The system diagnostic is available for MXC systems only. If any legacy DCS hardware is connected, the system diagnostic is disabled.

## System diagnostic

**Event log :**

```

Network topology saved
Reference network comparison status | Fail: Unit missing from network | 006.182.226
Network mapping completed | Success
System started
Upgrade complete. Reboot to enable network diagnostics
Upgrade complete. Reboot to enable network diagnostics
System started
Upgrade complete. Reboot to enable network diagnostics
Upgrade complete. Reboot to enable network diagnostics
Reference network comparison status | Fail: Unit missing from network | 006.182.226

```

**Network :**

**Indication :**

DCS-LAN connection	First unit	Last unit	Type
DIS-CCU out A	Seat 6	Booth 1/1	Chain

## Report

1. Go to *Diagnostics > Report*.
2. Click either the *Network topology* or *System diagnostic* button to generate the selected report.

**Note:** To generate a network topology report, you must first save the reference network under *Diagnostics > System diagnostic*.

3. Save the resulting file and send it to the Shure support group for analysis.



```

Diagnostics Report
-----
rootfs:b6809 i17390 bn0 - 6809 n
FFDA: 00000003/0005000d
=====
({'contents':
  Central Unit Version
  Hardware ID : DCS-CCU
  BoardInfo : 0x9103
  Serial Number : 004.246.188
  LAN MAC Address: es:67:ba:00:20:ea
  Firmware Version: 0.26.153
  Rootfs version : b6809 i17390 bn0});
=====
({'contents':
  Addr. Serial nbr. Type State
  1 002.003.006 A 'DCS9xx DM' '- - - V -' 'Active(active)'
  2 002.003.191 A 'DCS9xx DM' '- - - V -' 'Active(active)'
  3 002.005.050 A 'DCS9xx DM' '- - - V -' 'Active(active)'
  4 004.110.078 A 'DCS9xx DM' '- - - V C' 'Active(active)'
  5 002.111.097 A 'DCS9xx DM' '- - - V -' 'Active(active)'
  6 004.107.231 A 'DCS9xx DM' '- - - V C' 'Active(active)'
  7 004.045.203 A 'DCS9xx DM' '- - - V C' 'Active(active)'
  8 004.229.080 A 'DCS9xx DM' '- - - V -' 'Active(active)'

Nbr of units (Active/Lost):
Chain A 8/0
Chain B 0/0
Chain C 0/0
Chain D 0/0
Total 8/0 = 8
Unreq units 0

Addr. Ext.CU Id MIC IS AO Voting Chipcard Conference
4940 Ext.CU-000 No No No No No No
4041 Ext.CU-000 No No No No No No ');
=====
({'contents':
  CU License Information

```

## Backup, Restore, Factory Reset

### From the Browser Interface

1. Open the CCU browser interface.
2. Go to *System > Factory defaults & backup*.
  - Back up your current system configuration:
    1. Under *System backup*, click *Save*.
    2. Save the file to your computer or to external storage. Take note of the location of the backup file, which includes all CCU settings and participant setup entries.
  - Restore system settings from backup:
    1. Under *System backup*, click *Restore*.
    2. Locate and open the desired backup file.
    3. Click *Reset* to reboot the system.
  - Reset the system to factory defaults:
    1. Under *Reset to factory defaults*, click *Reset*.
    2. Wait for the system to reboot. The computer will lose connection to the browser interface during this time.

### From the Hardware

This will revert the CCU to factory settings, erasing all participant, system and IP settings. The unit will reboot in 5900 mode.

1. Go to the front panel of the CCU.
2. Scroll the main menu to *System > Restore factory def..* Press the center button to enter menu.
3. Press the center button to select *OK* and confirm the reset.
4. Wait for the system to reboot. The computer will lose connection to the browser interface during this time.

## Devices and Accessories

Chairman button set for MXC615/620	MXC615-620-ACC-CM
Chairman button set for MXC630/640	MXC630-640-ACC-CM
A/B buttons for MXC615/620, qty 10	MXC615/620-ACC-A/B
A/B buttons for MXC630/640, qty 10	MXC630/640-ACC-A/B
Mute button for MXC615/620, qty 10	MXC615/620-ACC-M
Mute button for MXC630/640, qty 10	MXC630/640-ACC-M
Reply button for MXC615/620, qty 10	MXC615/620-ACC-RPY
Reply button for MXC630/640, qty 10	MXC630/640-ACC-RPY
Braille "Mute/Speak" button overlay for MXC615/620	95A38214
HDMI cable with locking connector	95A37040

## Model Variations

### CCU Variations

Central control unit, without power supply	DIS-CCU
Central control unit, with power supply for Europe	DIS-CCU-E
Central control unit, with power supply for UK	DIS-CCU-UK
Central control unit, with power supply for U.S.	DIS-CCU-US
Central control unit, with power supply for Argentina	DIS-CCU-AR
Central control unit, with power supply for Brazil	DIS-CCU-BR

### CCU Feature Licenses

DIS-CCU feature license for operation with the DCS6000 System	FL6000
DIS-CCU feature license for additional participants in the DCS6000 System (up to 3,800 seats)	FL6000-3800
DIS-CCU feature license for additional interpretation channels in the DCS6000 System (up to 8 channels)	FL6000-INT-8
DIS-CCU feature license for additional interpretation channels in the DCS6000 System (up to 16 channels)	FL6000-INT-16
DIS-CCU feature license for additional interpretation channels in the DCS6000 System (up to 31 channels)	FL6000-INT-31

## PS-CCU Power Supply

Power supply for the CCU, DCS-LAN power kits, and inserters.

### PS-CCU Model Variations

<b>Power supply for U.S.</b>	PS-CCU-US
<b>Power supply for Argentina</b>	PS-CCU-AR
<b>Power supply for Australia</b>	PS-CCU-AZ
<b>Power supply for Brazil</b>	PS-CCU-BR
<b>Power supply for China</b>	PS-CCU-CHN
<b>Power supply for Europe</b>	PS-CCU-E
<b>Power supply for India</b>	PS-CCU-IN
<b>Power supply for Japan</b>	PS-CCU-J
<b>Power supply for Korea</b>	PS-CCU-K
<b>Power supply for Taiwan</b>	PS-CCU-TW
<b>Power supply for UK</b>	PS-CCU-UK

### Inline Power Inserter Kits

<b>Inline power inserter, without power supply</b>	PI-6001
<b>Inline power inserter, with power supply for U.S.</b>	PI-6000-US
<b>Inline power inserter, with power supply for Argentina</b>	PI-6000-AR
<b>Inline power inserter, with power supply for Brazil</b>	PI-6000-BR
<b>Inline power inserter, with power supply for Europe</b>	PI-6000-E
<b>Inline power inserter, with power supply for UK</b>	PI-6000-UK

## Optional Accessories and Replacement Parts

<b>Redundancy Interface Box for DCS-LAN</b>	MXC-ACC-RIB
<b>Dual-card for MXC/MXCW/DCS, qty 10</b>	MXCDualCard-10pk
<b>Distribution box with 4 outputs. DCS6000 and DDS 5900 systems</b>	JB 6104
<b>Spare Part Set CU 59xx/CU 61xx</b>	SPS CU
<b>DCS-LAN extension unit for additional conference units</b>	EX 6010
<b>Inline data repeater for DCS-LAN network; 1 input x 4 outputs</b>	RP 6004

## Pre-Tested Shure Cables

Shure offers individually-tested cables for Shure conferencing and discussion equipment. The EC 6001 are high-quality, shielded Cat5e cables available various lengths from 0.5 m to 100 m. Made with male-to-male shielded connectors.

### Male-to-Male Patch Cables

<b>0.5 m black shielded Cat5e F/UTP cable (shielded RJ45)</b>	EC 6001-0.5
<b>1 m black shielded Cat5e F/UTP cable (shielded RJ45)</b>	EC 6001-01
<b>2 m black shielded Cat5e F/UTP cable (shielded RJ45)</b>	EC 6001-02
<b>3 m black shielded Cat5e F/UTP cable (shielded RJ45)</b>	EC 6001-03
<b>5 m black shielded Cat5e F/UTP cable (shielded RJ45)</b>	EC 6001-05
<b>10 m black shielded Cat5e F/UTP cable (shielded RJ45)</b>	EC 6001-10
<b>20 m black shielded Cat5e F/UTP cable (shielded RJ45)</b>	EC 6001-20
<b>30 m black shielded Cat5e F/UTP cable (shielded RJ45)</b>	EC 6001-30
<b>50 m black shielded Cat5e F/UTP cable (shielded RJ45)</b>	EC 6001-50
<b>100 m black shielded Cat5e F/UTP cable (shielded RJ45)</b>	EC 6001-100

## Technical Specifications

### Microflex Complete System

The MXC system conforms to ISO 22259, the international standard for conference systems.

Audio performance specifications are measured from the audio input of a conference unit to the headphone output of a conference unit.

### Wiring Details

#### Connection to Main Power Supply

<b>Blue</b>	Neutral
<b>Brown</b>	Live
<b>Green/Yellow</b>	Earth (Ground)

#### DCS-LAN Chain

The CCU uses Cat5e, Cat6 or Cat7 F/UTP or U/FTP cables with shielded RJ45 connectors.

EIA 568-B wiring must be used.

**Important:** The names of Cat5/6/7 cable type have changed.

Old Name	New Name
FTP	F/UTP
STP	U/FTP
UTP	U/UTP

**Important:** Use only F/UTP or U/FTP (screened) cables and screened RJ45 connectors and not U/UTP cable, which is unshielded.

How to wire a Cat5e (EIA 568-B) cable to a RJ45 con.:

Pin	Function	Connector #1	Connector #2
1	In-going +	ORG/WHT	ORG/WHT
2	In-going -	ORG	ORG
3	+48V	GRN/WHT	GRN/WHT
4	0V	BLU	BLU
5	0V	BLU/WHT	BLU/WHT
6	+48V	GRN	GRN
7	Outgoing -	BRN/WHT	BRN/WHT
8	Outgoing +	BRN	BRN

If other color codes are used then the four pairs are connected as follows:

**Pair 2:** Pin 1 & 2

**Pair 3:** Pin 3 & 6

**Pair 1:** Pin 4 & 5

**Pair 4:** Pin 7 & 8

The phase of the pairs must be correct and the wiring specification EIA 568-B (Cat5e).

Cat6 and Cat7 cables are normally only terminated in sockets (female) and not in cable plugs.

Cat6 and Cat7 can only be used for feeding cables terminating in wall outlets or patch panels.

## Analog Audio Out

XLR3 male

Pin	Signal	Cable type
1	Earth	2 x 0.25 mm <sup>2</sup> shielded.
2	Signal +	
3	Signal -	

## Analog Audio In

XLR3 female

Pin	Signal	Cable type
1	Earth	2 x 0.25 mm <sup>2</sup> shielded.
2	Signal +	
3	Signal -	

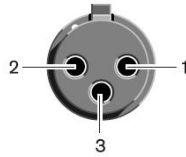

## Emergency Switch

Terminal block

Connect the emergency switch to pin 1 and 2.

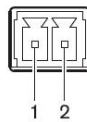

## Earphones

3.5 mm Jack plug

Pin	Connector	Function
1	Tip	Signal left
2	Ring	Signal Right
3	Sleeve	Electrical earth/screen



## Common System Specifications

### Latency

Microphone Input to Headphone Output	5.5ms
Microphone Input to Analog out	6.25ms
Analog in to Headphone Output	7.25ms

### THD+N

0.2%

**Digital Signal Processing**

24-bit, 32 kHz

**Mean Time Between Failures**

&gt;400,000 hours

**Operating Temperature Range**

0°C (32°F) - 35°C (95°F)

**Storage Temperature Range**

-20°C (-4°F) - 50°C (122°F)

**Relative Humidity**

95% (maximum)

## Conference Unit Specifications

**Audio Frequency Response**

<b>Loudspeaker Output</b>	200 Hz - 16 kHz (+0.5/-10 dB)
<b>Headphone Output</b>	110 Hz - 16 kHz (+0.5/-3 dB)

**Polarity**

Positive pressure on diaphragm produces positive voltage on pin 2 with respect to pin 3 (DIS-CCU Output)

**Microphone Connector**

10-pin gooseneck, Unbalanced

**Pin Assignments**

Proprietary Shure Pinout

**Headphone Output**

dual mono (will drive stereo phones)

**Network Connections**

DCS-LAN

**Power Supply**

DCS-LAN (DIS-CCU, EX6010, PI6000)

**Voltage At Source**

48 V

**Cable Requirements**

Shielded Cat 5e or higher

**NFC Carrier Frequency**

13.56 MHz

**Antenna Type**

Internal NFC Loop

**NFC Card Compatibility**

ACOS3 dual interface and contactless

**Color**

Black

**Housing**

Molded Plastic, Aluminum

**MXC615****Dimensions**

75.3 x 154.9 x 170.7 mm (3.0 x 6.1 x 6.8 in.)H x W x D

**Weight**

770 g (27.2 oz.)

**Screen Type**

OLED

**Screen Size**

19.37 x 7.86 mm (0.76 x 0.31 in.)

**Display Resolution**

96 x 39 (125 PPI)

**Power Consumption**

<b>Typical</b>	1.8 W
<b>Maximum</b>	2.8 W

**MXC620 / MXC620-F****Dimensions**

<b>MXC620</b>	75.3 x 154.9 x 170.7 mm (3.0 x 6.1 x 6.8 in.) H x W x D
<b>MXC620-F</b>	90 x 235 x 72 mm (3.543 x 9.252 x 2.835 in.) H x W x D

**Weight**

<b>MXC620</b>	790 g (27.9 oz.)
<b>MXC620-F</b>	1160 g (40.9 oz.)



## Screen Type

OLED

## Screen Size

19.37 x 7.86 mm (0.76 x 0.31 in.)

## Display Resolution

96 x 39 (125 PPI)

## Power Consumption

<b>MXC620 Typical Typical</b>	1.9 W
<b>MXC620 Maximum</b>	3.8 W
<b>MXC620-F Typical</b>	1.9 W
<b>MXC620-F Maximum</b>	3.6 W

## MXC630 / MXC630-F

## Dimensions

<b>MXC630</b>	74 x 268 x 153 mm (2.9 x 10.6 x 6.0 in.) H x W x D
<b>MXC630-F</b>	90 x 235 x 72 mm (3.5 x 9.3 x 2.8 in.) H x W x D

## Weight

<b>MXC630</b>	1020 g (36.0 oz.)
<b>MXC630-F</b>	1160 g (40.9 oz.)

## Screen Type

OLED

## Screen Size

19.37 x 7.86 mm (0.76 x 0.31 in.)

## Display Resolution

96 x 39 (125 PPI)

## Power Consumption

<b>MXC630 Typical</b>	1.9 W
<b>MXC630 Maximum</b>	4.1 W
<b>MXC630-F Typical</b>	1.9 W
<b>MXC630-F Maximum</b>	3.6 W

## MXC640

### Dimensions

74 x 268 x 153 mm (2.9 x 10.6 x 6.0 in.)

### Weight

1080 g (38.1 oz.)

### Screen Type

Color TFT LCD with Capacitive Touch Screen

### Screen Size

109.2 mm (4.3 in.)

### Display Resolution

480 x 272 (128 PPI)

### Power Consumption

<b>Typical</b>	2.8 W
<b>Maximum</b>	4.8W

## MXCMIU

### Dimensions

<b>MXCMIU</b>	40 x 140 x 78 mm (1.6 x 5.5 x 3.1 in.) H x W x D
<b>MXCMIU-FS</b>	39 x 90 x 90 mm (1.5 x 3.5 x 3.5 in.) H x W x D
<b>MXCMIU-FL</b>	39 x 160 x 90 mm (1.5 x 6.3 x 3.5 in.) H x W x D

### Weight

<b>MXCMIU</b>	400 g (14.1 oz.)
<b>MXCMIU-FS</b>	360 g (12.7 oz.)
<b>MXCMIU-FL</b>	670 g (23.6 oz.)

### Power Consumption

<b>MXCMIU Typical</b>	1.8 W
<b>MXCMIU Maximum</b>	2.0 W
<b>MXCMIU-FS Typical</b>	0.1 W
<b>MXCMIU-FS Maximum</b>	0.6 W
<b>MXCMIU-FL Typical</b>	0.1 W
<b>MXCMIU-FL Maximum</b>	0.9 W

## MXCMIU Connection to MXCMIU-FS / MXCMIU-FL

HDMI, x2

## Maximum Cable Length

5m

## XLR Input

## Maximum Input Level

<b>PAD OFF</b>	-21.1 dBV
<b>PAD ON</b>	21.7 dBV

## Audio Frequency Response

50 Hz - 14.3 kHz (+0.5/-3 dB)

## THD+N

0.07%

## Dynamic Range

<b>PAD OFF , Unweighted</b>	89.5 dB
<b>PAD OFF , A-Weighted</b>	91 dB
<b>PAD ON , Unweighted</b>	115 dB
<b>PAD ON , A-Weighted</b>	116 dB

## Input Impedance

17 k $\Omega$  at 1 kHz

## Configuration

Balanced

## Type

3-pin XLR

## Pin Assignments

1=ground, 2=audio +, 3=audio -

## GND Lift

<b>Left</b>	GND Connected
<b>Right</b>	GND Disconnected

## MXCIC

## Audio Output Type

3.5mm female socket (x2, dual mono, TRRS) 6.35mm female socket (x1, stereo, TRS)

## Dimensions

198 x 324 x 96 mm (7.8 x 12.8 x 3.8 in.) H x W x D

## Weight

2250 g (79.4 oz.)

## Screen Type

Color TFT Display

## Screen Size

160 mm (6.3 in.)

## Display Resolution

800 x 240 (134 PPI)

## Power Consumption

<b>Typical</b>	5.5 W
<b>Maximum</b>	7.0W

## Number of Incoming Channels

Up to 32 (31 + Floor)

## Number of Outgoing Channels

3 (A/B)

## Maximum Units Per Booth

32

## Maximum Number of Booths

150

## Maximum Number of Units (total)

128

# Audio Specifications

## Audio Input

### Nominal Input Level

-60 dBV

### Maximum Audio Input Level

<b>Microphone</b>	-1.5 dBV at 1% THD
<b>Headset</b>	-5.5 dBV at 1% THD

## Audio Frequency Response

20 Hz - 16 kHz (+0.5/-10 dB)

## THD+N

<b>Microphone Input</b>	0.04%
<b>Headset Input</b>	0.07%

## Dynamic Range

<b>Microphone Input , Unweighted</b>	110 dB
<b>Microphone Input , A-Weighted</b>	112 dB
<b>Headset Input , Unweighted</b>	92 dB
<b>Headset Input , A-Weighted</b>	94 dB

## Preamplifier Equivalent Input Noise (EIN)

-115.8 dBV

## Input Impedance

<b>Microphone</b>	26 k $\Omega$
<b>Headset</b>	2.2 k $\Omega$

## Audio Output

## Nominal Output Level

70 dB SPL at 0.5m

## Maximum Audio Output Level

<b>Loudspeaker Output</b>	82 dB SPL-A at 0.5m
<b>Headphone Output</b>	1.7 dBV

## Audio Frequency Response

<b>Speaker Output</b>	200 Hz - 16 kHz (+0.5/-10 dB)
<b>Headphone Output</b>	110 Hz - 16 kHz (+0.5/-3 dB)

## THD+N

<b>Loudspeaker Output</b>	<1%
<b>Headphone Output</b>	<0.2%

## Dynamic Range

<b>Speaker Output , Unweighted</b>	88 dB (MXCIC = 92 dB)
<b>Speaker Output , A-Weighted</b>	90 dB (MXCIC = 95 dB)
<b>Headphone Output , Unweighted</b>	91 dB (MXCIC = 91 dB)
<b>Headphone Output , A-Weighted</b>	93 dB (MXCIC = 93 dB)

## Load Impedance

>8  $\Omega$

---

## Cleaning

To keep the cabinet in original condition, periodically wipe it down with a soft cloth. Stubborn stains may be removed with a cloth lightly dampened with a mild detergent solution. Never use organic solvents such as thinners or abrasive cleaners since these will damage the cabinet.

## Repacking

Save the original shipping box and packing material; they may be used to ship the unit. For maximum protection, re-pack the unit as originally packed from the factory.

## Warranty

The units are covered by a 24 month warranty against defects in materials or workmanship.

## Important Product Information

The equipment is intended to be used in professional audio applications.

*Changes or modifications not expressly approved by Shure Incorporated could void your authority to operate this equipment.*

**Note:** *This device is not intended to be connected directly to a public internet network.*

*EMC conformance to Environment E2: Commercial and Light Industrial. Testing is based on the use of supplied and recommended cable types. The use of other than shielded (screened) cable types may degrade EMC performance.*

This device complies with part 15 of the FCC Rules. Operation is subject to the following two conditions: (1) This device may not cause harmful interference, and (2) this device must accept any interference received, including interference that may cause undesired operation.

## Information to the user

This equipment has been tested and found to comply with the limits for a Class A digital device, pursuant to Part 15 of the FCC Rules. These limits are designed to provide reasonable protection against harmful interference when the equipment is operated in a commercial environment. This equipment generates, uses, and can radiate radio frequency energy and, if not installed and used in accordance with the instruction manual, may cause harmful interference to radio communications. Operation of this equipment in a residential area is likely to cause harmful interference in which case the user will be required to correct the interference at his own expense.

This equipment complies with FCC radiation exposure limits set forth for an uncontrolled environment. This equipment should be installed and operated with minimum distance 23 cm between the radiator & your body.

This Class A digital apparatus complies with Canadian ICES-003. Cet appareil numérique de la classe A est conforme à la norme NMB-003 du Canada.

This device contains licence-exempt transmitter(s)/receiver(s) that comply with Innovation, Science and Economic Development Canada's licence-exempt RSS(s). Operation is subject to the following two conditions:

1. This device may not cause interference.
2. This device must accept any interference, including interference that may cause undesired operation of the device.

L'émetteur/récepteur exempt de licence contenu dans le présent appareil est conforme aux CNR d'Innovation, Sciences et Développement économique Canada applicables aux appareils radio exempts de licence. L'exploitation est autorisée aux deux conditions suivantes :

1. L'appareil ne doit pas produire de brouillage;
2. L'appareil doit accepter tout brouillage radioélectrique subi, même si le brouillage est susceptible d'en compromettre le fonctionnement.

---

# Certifications

This product meets the Essential Requirements of all relevant European directives and is eligible for CE marking.

EAC Clarification: This product meets Russian compliance regulations as well as EAC marking requirements.

Hereby, Shure Incorporated declares that the radio equipment is in compliance with Directive 2014/53/EU. The full text of the EU declaration of conformity is available at the following internet address: <http://www.shure.com/europe/compliance>

Authorized European representative:

Shure Europe GmbH

Headquarters Europe, Middle East & Africa

Department: EMEA Approval

Jakob-Dieffenbacher-Str. 12

75031 Eppingen, Germany

Phone: +49-7262-92 49 0

Fax: +49-7262-92 49 11 4

Email: [EMEAsupport@shure.de](mailto:EMEAsupport@shure.de)