



iLoud[®] MTM

High resolution compact studio monitors
with Midwoofer-Tweeter-Midwoofer design

USER MANUAL

Table of Contents

Contents	2
English	3
iLoud MTM	3
Register your iLoud MTM	3
Safety Instructions	4
iLoud MTM overview	6
Installation and setup	7
Control panel	11
Audio inputs	11
ARC Mic input	11
Volume	11
USB port	11
Power	11
Rear controls	12
LF extension	12
HF filter	12
LF filter	12
CAL/Preset	12
Custom Calibration	13
Front LED	16
MTM design	17
Desktop positioning	18
Listening position	19
Room acoustics	19
Microphone stand mounting	20
DFU mode	20
Troubleshooting	21
Specifications	21
Graphics	22
Warranty	24
Support and more info	24

iLoud MTM

Thank you for purchasing iLoud MTM.

Your package contains:

- iLoud MTM speaker (single)
- Power cord*
- Tilting stand
- Stand's locking key
- TPU base for horizontal positioning
- ARC microphone and clamp
- XLR to 1/8" TS cable for ARC microphone
- Quick start guide
- Registration card

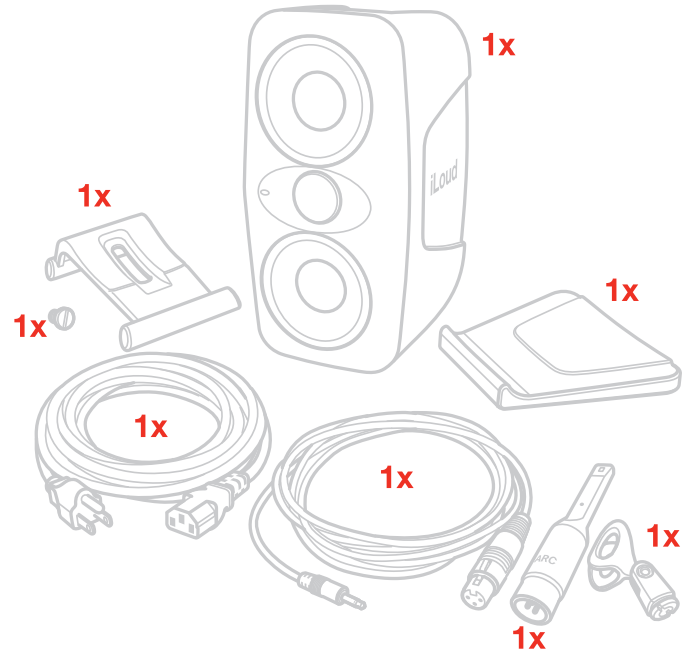

iLoud MTM's innovative features and smart design re-invent studio monitoring for any kind of setup, from professional studios looking for transparent, revealing nearfields, to musicians in home and small studios looking for absolute precision from their work-horse monitors.

iLoud MTM offers a flat frequency and phase response, never before found on monitors even at double the price of iLoud MTM, to provide unbelievably revealing, true-to-life sound with no ear fatigue, that makes working on any kind of audio material a joy.

Register your iLoud MTM

By registering, you can access technical support, activate your warranty and receive free JamPoints™ which will be added to your account. JamPoints™ allow you to obtain discounts on future IK purchases! Registering also keeps you informed of all the latest software updates and IK products.

Register at: www.ikmultimedia.com/registration

Safety Instructions

- Read these instructions.
- Keep these instructions.
- Heed all warnings.
- Follow all instructions.
- Do not use this apparatus near water.
- Clean only with dry cloth.
- Do not block any ventilation openings. Install in accordance with the manufacturer's instructions.
- Do not install near any heat sources such as radiators, heat registers, stoves, or other apparatus (including amplifiers) that produce heat.
- Do not defeat the safety purpose of the polarized or grounding-type plug. A polarized plug has two blades with one wider than the other. A grounding type plug has two blades and a third grounding prong. The wider blade or the third prong are provided for your safety. If the provided plug does not fit into your outlet, consult an electrician for replacement of the obsolete outlet.
- Protect the power cord from being walked on or pinched particularly at plugs, convenience receptacles, and the point where they exit from the apparatus.
- Only use attachments/accessories specified by the manufacturer.
- Use only with the cart, stand, tripod, bracket, or table specified by the manufacturer, or sold with the apparatus. When a cart is used, use caution when moving the cart/apparatus combination to avoid injury from tip- over.
- Unplug this apparatus during lightning storms or when unused for long periods of time.
- Refer all servicing to qualified service personnel. Servicing is required when the apparatus has been damaged in any way, such as power-supply cord or plug is damaged, liquid has been spilled or objects have fallen into the apparatus, the apparatus has been exposed to rain or moisture, does not operate normally, or has been dropped.
- To reduce the risk of fire or electric shock, do not expose this apparatus to rain or moisture. The apparatus shall not be exposed to dripping or splashing and that objects filled with liquids, such as vases, shall not be placed on apparatus.
- Where the Mains plug or an appliance coupler is used as the disconnect device, the disconnect device shall remain readily operable.
- Do not overload wall outlets or extension cords beyond their rated capacity as this can cause electric shock or fire.
- No naked flame sources, such as lighted candles, should be placed on the apparatus.
- The ventilation should not be impeded by covering the ventilation openings with items, such as newspapers, table cloths, curtains, etc.
- Correct Disposal of this product. This marking indicates that this product should not be disposed with other household wastes throughout the EU. To prevent possible harm to the environment or human health from uncontrolled waste disposal, recycle it responsibly to promote the sustainable reuse of material resources. To return your used device, please use the return and collection systems or contact the retailer  where the product was purchased. They can take this product for environmental safe recycling.

- The lightning flash with arrowhead symbol within an equilateral triangle is intended to alert the user to the presence of uninsulated “dangerous voltage” within the product’ s enclosure that may be of sufficient magnitude to constitute a risk of electrical shock to persons.
- The exclamation point, within an equilateral triangle, is intended to alert the user to the presence of important operating and maintenance (servicing) instructions in the literature accompanying the product.
- **WARNING:** Do Not Open! Risk of Electrical Shock. Voltages in this equipment are hazardous to life. No user-serviceable parts inside. Refer all servicing to qualified service personnel. Place the equipment near a main power supply outlet and make sure that you can easily access the power breaker switch.
- **WARNING:** This product is intended to be operated ONLY from the AC Voltages listed on the back panel or included power supply of the product. Operation from other voltages other than those indicated may cause irreversible damage to the product and void the products warranty. The use of AC Plug Adapters is cautioned because it can allow the product to be plugged into voltages in which the product was not designed to operate. If the product is equipped with a detachable power cord, use only the type provided with your product or by your local distributor and/or retailer. If you are unsure of the correct operational voltage, please contact your local distributor and/or retailer.

iLoud MTM overview



Installation and setup

We recommend using high quality audio cables to guarantee optimal performance. It is important to ensure that the speakers stand firmly on a solid surface. Please note that the loudspeakers will need a few days to achieve optimum sonic performance.

1. Make sure that the volume control of iLoud MTM is set to minimum. Make sure that the ON/OFF switch on the rear panel is set to OFF.
2. Install the adjustable foot on the bottom of the iLoud MTM with the locking key. You can adjust the inclination of the speaker from 0° to 20°. Once reached the desired inclination angle, tighten the locking key. **IMPORTANT:** make sure that you tighten the locking key on the correct threaded insert at the bottom of iLoud MTM. The second threaded insert is intended for installing the iLoud MTM on top of a microphone stand.

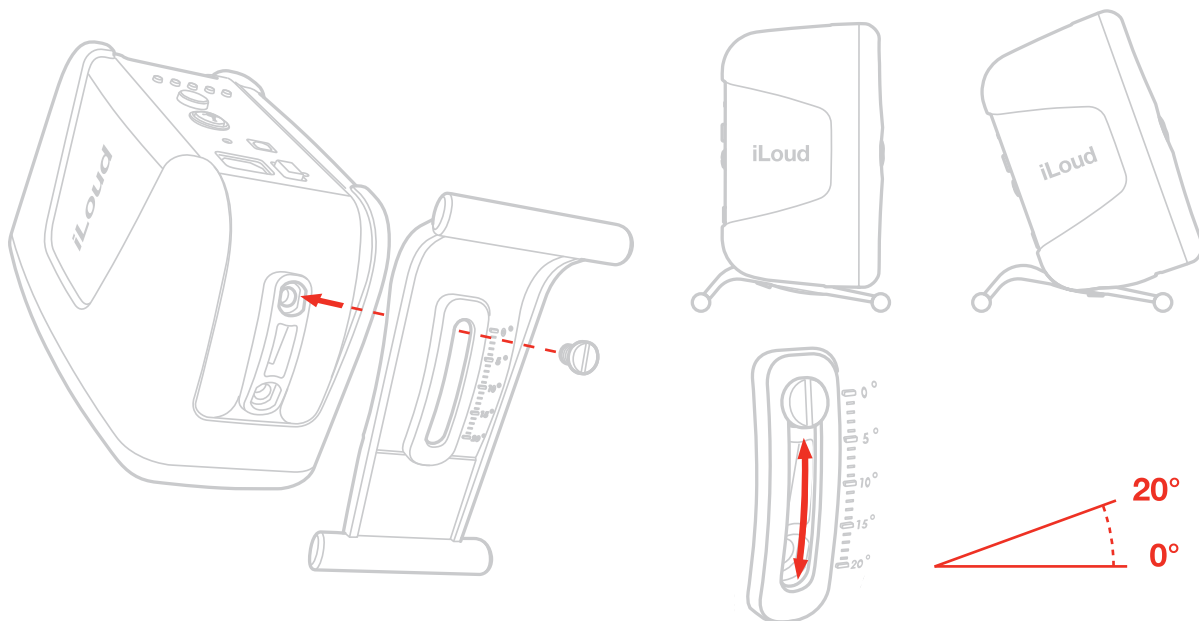

3. Adjust the **vertical alignment** of the speaker. This step is crucial to fully benefit from the MTM design (for more information refer to the dedicated paragraph in this manual).

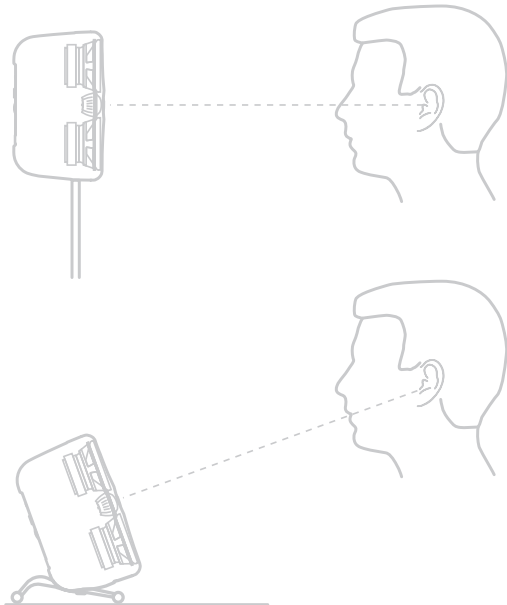

4. Connect the power cord.

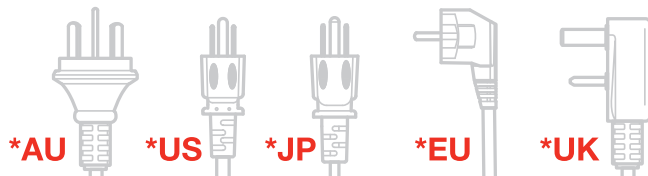
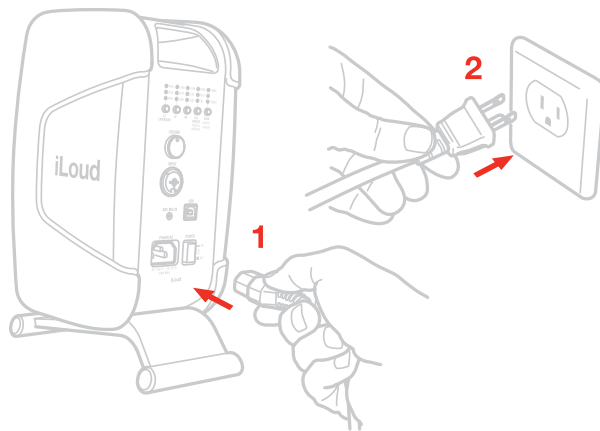

5. Connect the audio input source to the input connector of iLoud MTM.

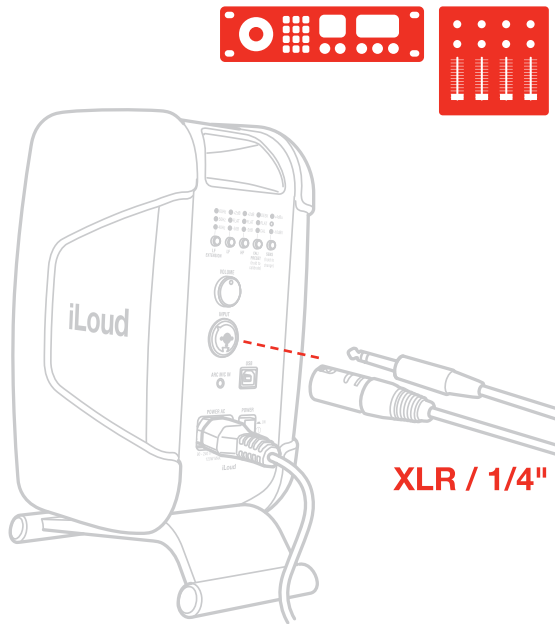

6. Switch ON the ON/OFF switch on the rear panel. The front LED will illuminate steady white after a short delay.

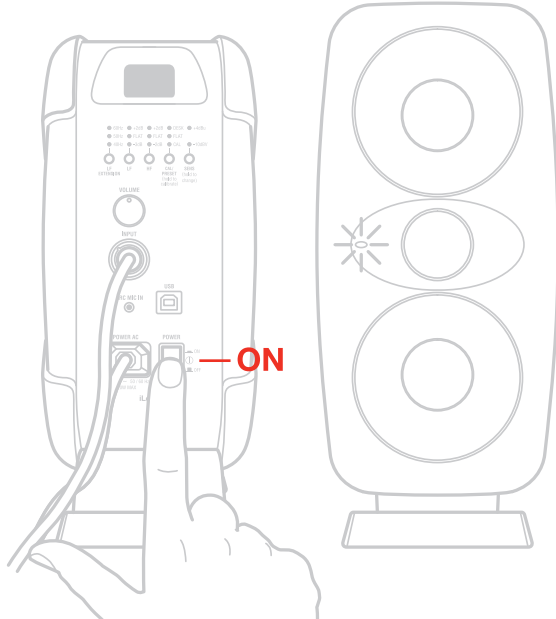

7. Turn your audio playback system on (Mixing console, Audio interface, etc.). Make sure you have set the proper input sensitivity using the SENS button, then set the volume control to MAX (full clockwise). This is the reference position for the SPL calibrated values in the specs. Adjust the volume control to a lower position only if needed or only in case you require different levels between the speakers.
8. If needed, adjust the speaker response with the dedicated controls on the rear panel.
9. You can perform a **speaker calibration** to perfectly fit your iLoud MTM into your acoustic environment (for more information refer to the dedicated paragraph in this manual).
10. It is possible to place the iLoud MTM horizontally using the supplied TPU support, however consider this as a second option because the performance of iLoud MTM is specifically optimized to better work with the acoustic environment when placed vertically. iLoud MTM has a controlled vertical dispersion that will make the sweet-spot on the horizontal axis to be quite narrow when placed horizontally.

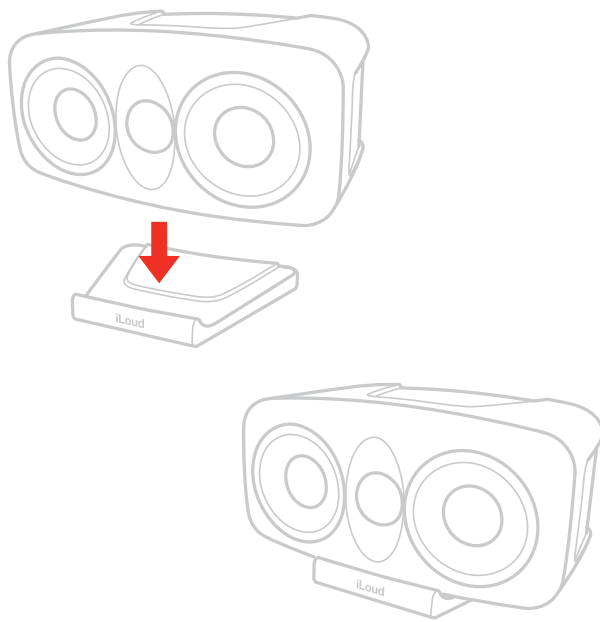

Note: Before plugging in and turning on, remember the “last on, first off” rule of powered speakers. When powering up your system, be sure that all the wires are connected, turn on your mixer/interface and any other outboard gear, and then lastly turn on your iLoud MTM. When powering down, turn your iLoud MTM off first and then your mixer/interface and outboard gear.

Control panel

Audio inputs

Combo XLR-1/4" balanced line input

This combo connector allows for the connection of an analog audio source (i.e., mixer/audio interface bal/unbal line out). Connect professional equipment with balanced outputs to the XLR or 1/4" TRS input of the speaker using balanced signal cables.

Sensitivity +4dBu/-10dBV

The +4dBu / -10dBV input sensitivity button allows connection of the speakers to high-output professional equipment without risk of input overload. It is possible to cycle between +4dBu and -10dBV by holding the SENS button for more than 2 seconds. The level is set to the +4dBu level when it ships from our factory. This setting will be best for most professional applications.

When connecting iLoud MTM to consumer equipment (as for example Hi-Fi components, smartphones, tablets, Laptop computers and so on), set the level to the -10dBV setting. To determine the nominal output level of the connected equipment, consult the documentation supplied with the connected equipment.

ARC Mic input

Use this 1/8" TS jack to connect the (included) ARC microphone that will allow you to perform a custom calibration of the speaker to perfectly fit your environment.

Volume

This control allows you to adjust the input level of the audio source from -12dB to 0dB.

USB port

This USB type-B port is only used for service purposes, such as Firmware updates or factory checks.

Power

Power button: this pushbutton allows you to power on and off your iLoud MTM.

Power AC: connect the (included) power cord to this AC socket.

IMPORTANT: before attempting to connect/disconnect the power cord, make sure that the power button is set to Off.

Rear controls

The pushbuttons on the back panel will help you to perfectly match iLoud MTM to every acoustic environment.

LF extension

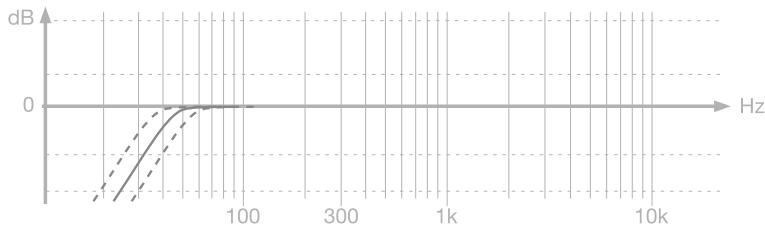

The LF extension button is a high-pass filter that can be set to filter out frequencies below 60Hz, 50Hz (default) or 40Hz.

HF filter

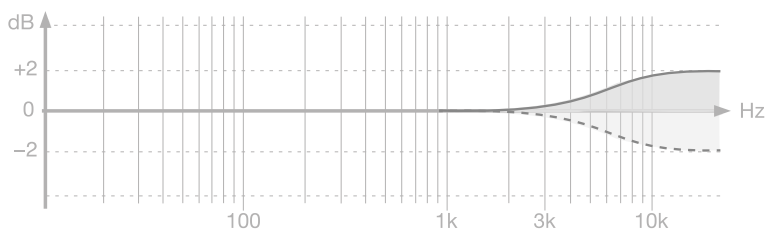

This pushbutton controls the high frequency level using a shelf-type EQ. The level can be set to 0dB (FLAT), +2dB or -2dB, from 8kHz up.

LF filter

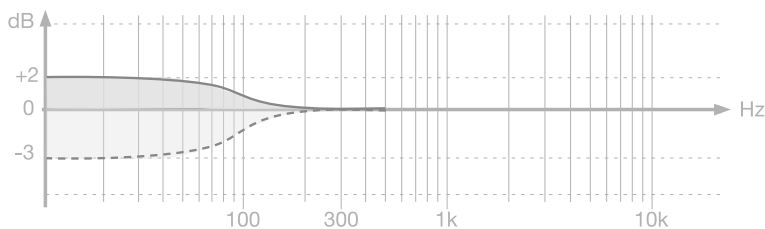

This pushbutton controls the low frequency level using a shelf-type EQ. The level can be set to 0dB (FLAT), +2dB or -3dB, from 100Hz down.

This filter is used to adjust the proximity effect of side walls and ceiling. Use this filter whenever the acoustics of your room cause problems in the low frequency range.

CAL/Preset

This pushbutton allows you to cycle between Desktop filter, FLAT (default) and custom user Calibration. The Desktop filter sets an attenuation filter to compensate for the typical acoustic effect of a console or a desk. Such placement usually results in a boost in the lower midrange. The Desktop switch activates a bell shaped notch filter, with a -4dB centered at 160Hz and +1dB at 1.8kHz.

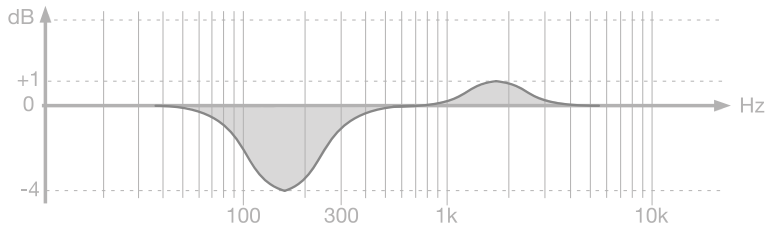

To perform a custom Calibration refer to the next paragraph.

IMPORTANT: units shipped from our factory have no custom calibration loaded, so the CAL position won't be available until a custom calibration has been performed by the user.

Custom Calibration

Thanks to the ARC technology, iLoud MTM can be tailored to perfectly fit your listening space. For this reason iLoud MTM is supplied with an ARC measurement microphone and its connecting cable. To begin a custom calibration:

- Connect the ARC microphone to the ARC Mic input on the back of iLoud MTM with the (included) XLR cable and make sure that the green LED on the microphone turns ON;

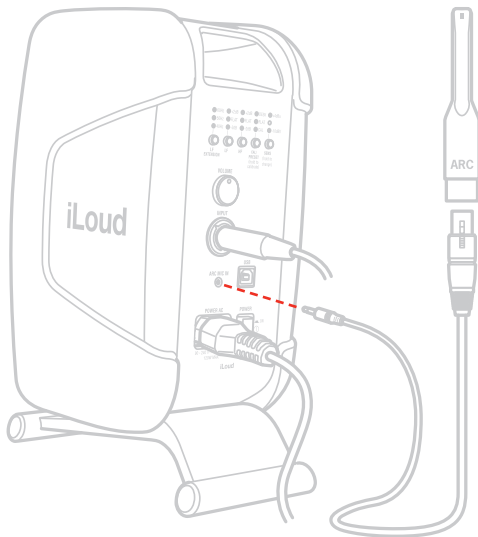

- place the microphone at the listening point, making sure the mic capsule aperture points towards the ceiling, and that the microphone is placed exactly in the center spot between the two speakers, at the listening position;

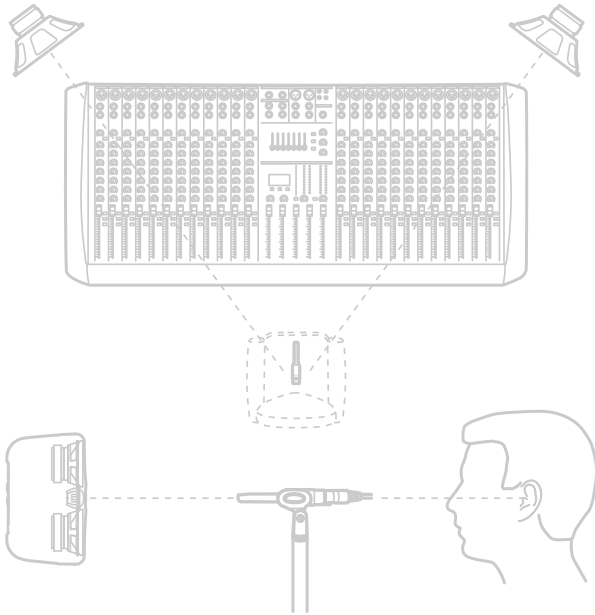

- keep the CAL/PRESET button pressed for more than 2 seconds;
- the CAL LED will start to blink blue and the front LED will start to blink white. Now you have 5 seconds of time to move yourself away from the speaker so that the measurements won't be influenced by you staying between the speaker and the microphone;

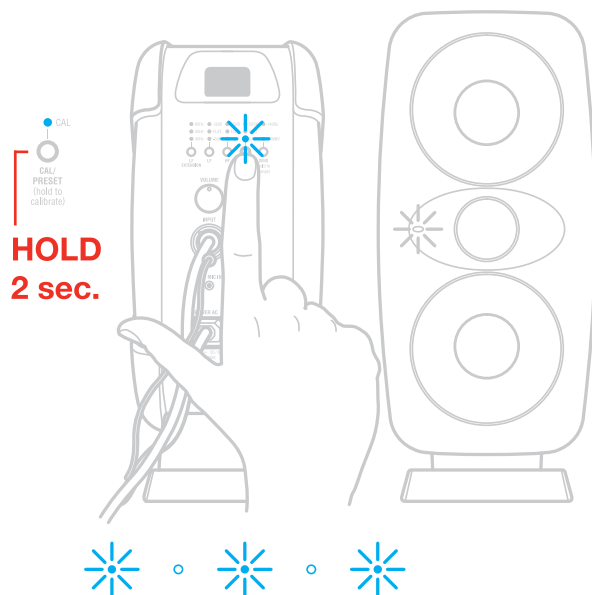

- at this point the calibration test signals production will start. During this time, the front LED will stay steady ON blue. **IMPORTANT:** during the measurement process make sure that the environment is as silent as possible, do not touch the speaker or the microphone, and make sure that the overall room setup is as similar as possible to the one that will be used during normal iLoud MTM usage.

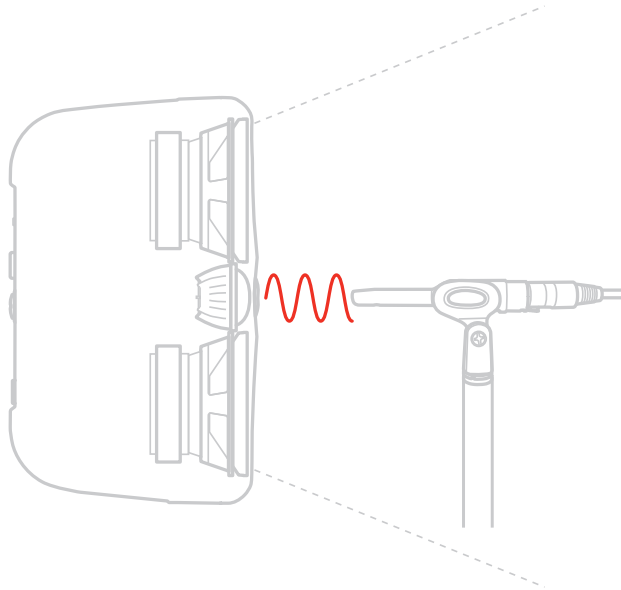

- following the audio sweeps, during the calculation process, the front LED will start to blink BLUE;
- When the process finishes, if the calibration has ended successfully, the front LED will blink GREEN for 4 seconds and the back CAL LED will turn steady ON; if, for some reason, the calibration ended unsuccessfully, the front LED will blink RED for 4 seconds and the back CAL LED won't turn ON. In this case try to perform another calibration.

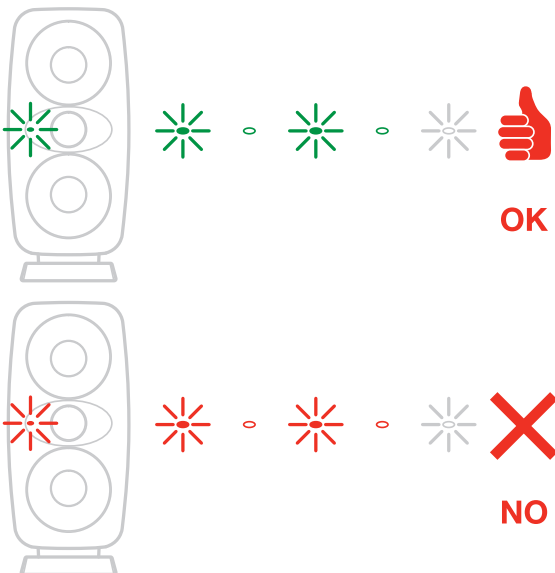

NOTE: the measurement signal level is independent from the volume control. The audio Sweep's level is fixed and optimised for best performance.

Factory reset: to perform a factory reset keep pressed both the CAL/PRESET and SENS buttons for more than 2 seconds. After this time all of the controls will be returned to the factory status and the, possibly saved, custom Calibration will be erased.

Front LED

The front LED will show important information about iLoud MTM's status.

Operating status

Steady white: iLoud MTM is ON. At power-on the front LED will blink white for few seconds then the speaker turns on and it will be ready to reproduce audio signals.

Blinking red: clipping. The speakers should never be overloaded to ensure consistent and reference audio reproduction. If you see the front LED to turn RED you should:

- lower the listening volume by turning down the control room / monitoring level on your console or audio interface.

OR

- Increase the LF extension control from 40 to 50 or 60 Hz to avoid the system being overloaded by bass.

Blinking white: calibration countdown.

Steady blue: calibration sweeps ongoing.

Blinking blue: calibration calculation.

Faults reporting

Steady red: Irrecoverable amplifier fault. No audio will be reproduced. Turn off the unit immediately.

Blinking orange: Thermal warning and the gain will be reduced by 6dB.

Steady orange: Thermal fault. No audio will be reproduced.

Steady yellow: Power amp fault. No audio will be reproduced.

Blinking purple: Internal Power supply issue. Contact support immediately.

MTM design

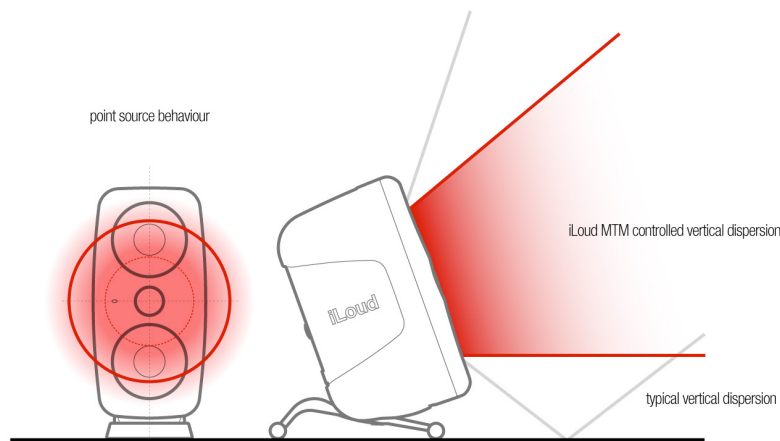

The MTM (Midwoofer-Tweeter-Midwoofer) design has a very uniform and smooth horizontal dispersion, and a more controlled, narrower vertical one.

This means that:

- ceiling and floor reflections are minimised, especially at mid and high frequencies, basically augmenting the focus the speakers can provide.
- in the same way, reflections from a desk are less problematic (causing less comb-filtering) than with a regular 2-way TM speaker.

This also means that the vertical alignment of the speaker with the listener's ears is crucial: a bad vertical alignment can cause substantial drops in the mid and high frequencies.

For this reason particular attention must be paid to the positioning of iLoud MTM.

Make sure that no obstacles are present between the monitors and your ears. You should be able to see the speakers completely. iLoud MTM has been designed for both vertical and horizontal set up. The speakers must be positioned on a firm surface or a stand.

Please note that vibration of nearby objects can mask the sound.

Desktop positioning

The center of the tweeter should be positioned approximately at the height of your ears. In case you need to position the speakers in a significant lower or higher position, the monitors should be angled accordingly. If the speakers are placed lower than the ear line, you can tilt them using the adjustable foot that, also, improves the acoustic decoupling of the speakers from the surface.

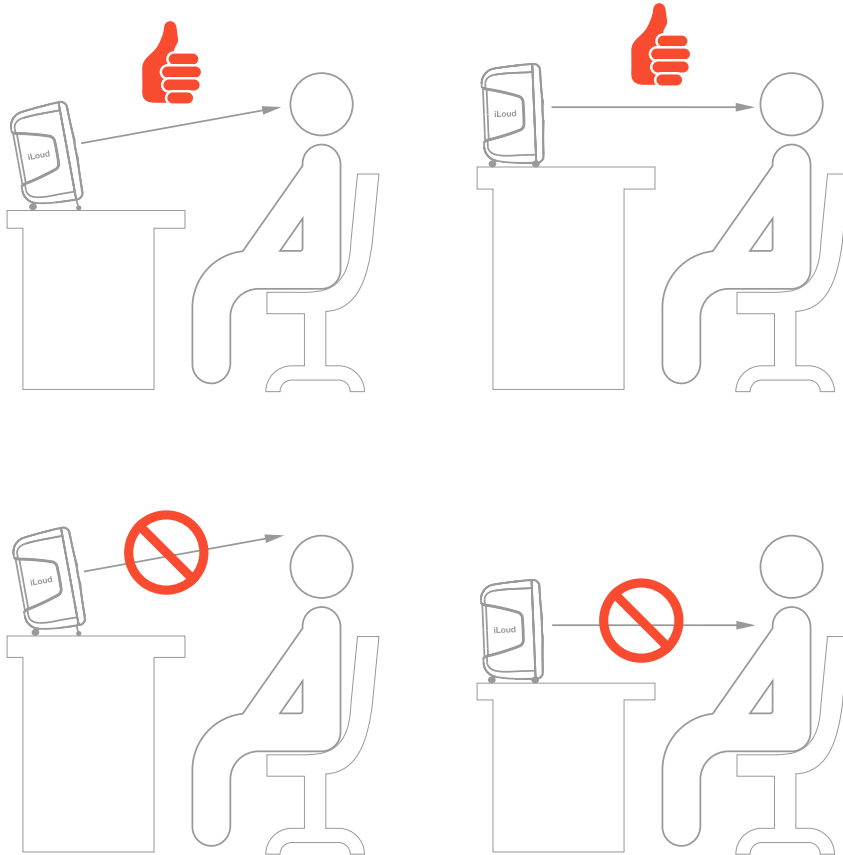

Listening position

When you use iLoud MTM for stereo applications, the optimum listening position should be located in the middle of an imaginary triangle. This means that your listening point (sweet spot) will be located at the top of an equilateral triangle and the two loudspeakers should be placed at the other two corners of this triangle. Furthermore, a symmetrical positioning is also important: this applies to the distance between speakers as well as to the walls, ceiling and floor. In order to have a symmetrical stereo image it is also important to have symmetrical reflections: we recommend keeping a distance of at least 20 cm (8 inches) from the walls, in order to avoid low frequency emphasis.

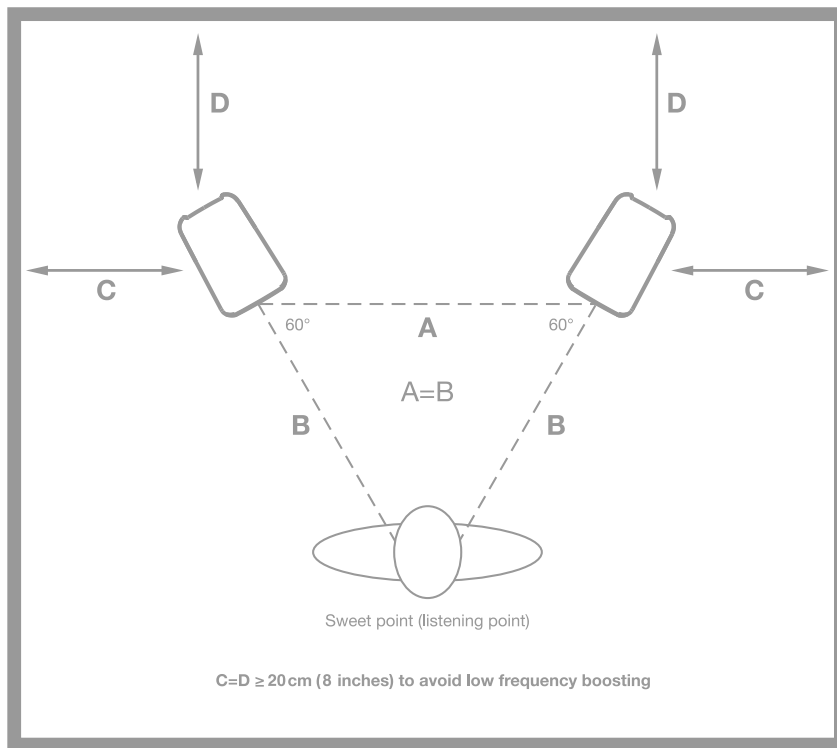

Room acoustics

The room acoustics plays a key role in the performance of your monitoring system. It is always advisable to make, at least, a minimum of acoustic treatment of your environment. This, along with the correct monitor's positioning, will improve the linearity and the precision of the listening experience.

Microphone stand mounting

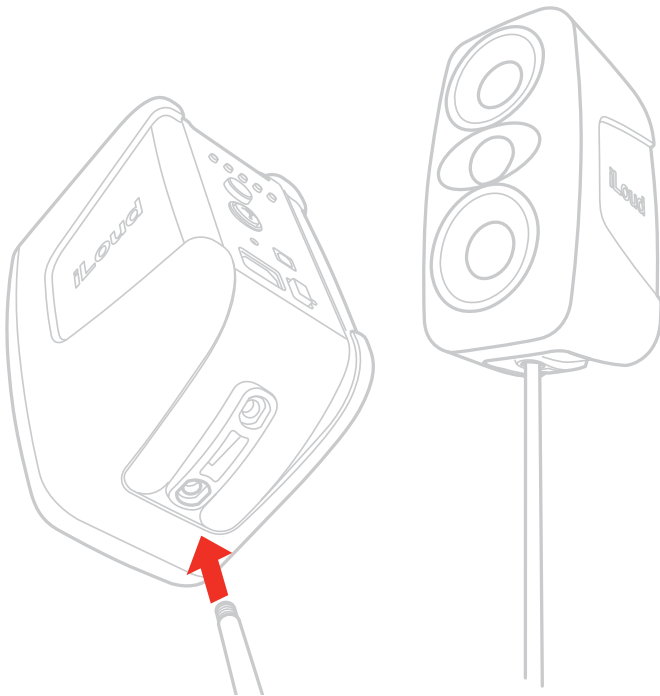

Thanks to the thread adapter on the bottom of the speaker, iLoud MTM can be mounted on any standard 3/8" microphone stand. This allows you to place the speakers at the perfect height and, most important, helps to reduce the typical reflections of the desktop (or shell) and, consequently, improves the frequency response/linearity of the speaker.

DFU mode

To update the firmware of your iLoud MTM you need to enter in DFU mode. To update your iLoud MTM:

- connect your iLoud MTM to a computer with a USB cable;
- enter the DFU mode: to enter the DFU mode, keep pressed the SENS button while powering up the iLoud MTM. While in DFU mode the front LED will start blinking white.
- Open the firmware updater application (available at www.ikmultimedia.com/iloudmtm) and follow the displayed instructions.
- The iLoud MTM needs to be restarted. Power off the unit, wait for at least 20 seconds and then turn it on again.
- The iLoud MTM is now updated.

Troubleshooting

I have connected my device to iLoud MTM but no sound comes out.

Make sure to set up the volume with the volume control on iLoud MTM and/or with your device's volume control.

Sound is distorted.

When noticeable distortion occurs, please turn down the level of the speakers, or of the connected audio source.

Calibration ended unsuccessfully (front LED blinks red)

If the calibration ends unsuccessfully and the front LED blinks red, make sure you have correctly inserted the XLR cable both on the microphone and on the 1/8" ARC mic input on the rear of iLoud MTM.

Specifications

- **Type:** 2-Way/3-speakers bi-amped, digitally controlled studio monitor
- **LF drivers:** 2 x 3.5" polypropylene custom-made mid-woofers
- **HD drivers:** 1" low distortion, back chambered silk dome tweeter
- **Acoustic design:** DSP tuned bass reflex
- **Number of amps per speaker:** 2
- **Amplifiers type:** High efficiency Class-D
- **Total power:** 100W RMS
- **LF power:** 70W RMS
- **HF power:** 30W RMS
- **Crossover type:** Linear Phase Variable Order
- **Crossover frequency:** 3.1kHz
- **Frequency response:** from 50 Hz to 24 kHz +/- 2dB (40 Hz -6dB when uncal, -3 dB when cal)
- **Phase response:** System remains coherent within +/- 15° from 200Hz to 20kHz
- **Sensitivity at +4dBu:** 0dBu signal generates a 100 dB SPL @ 1 m
- **Sensitivity at -10dBV:** -11dBu signal generates a 100 dB SPL @ 1 m
- **Maximum SPL @ 1m, one speaker playing, on axis:** 103dB from 200Hz up sine wave, 95dB at 100Hz sine, 93dB pink noise
- **Placement setup:** Manual switches for LF Extension, LF trim, HF trim, Desk position
- **LF extension switch:** Sets -3dB point of the frequency response at 40, 50 or 60 Hz
- **LF switch:** Low shelf, +2dB or -3dB from 100Hz down
- **HF switch:** High shelf, +2dB or -2dB from 8kHz up
- **Desk switch:** -4dB at 160Hz and +1dB at 1.8kHz
- **Calibration:** Fully automatic and built-in digital calibration, microphone included
- **Measurement microphone:** Omnidirectional, Mems based precision measurement microphone
- **Full DSP control**

- **Connectors:** 1x combo XLR-1/4" TRS balanced input; 1/8" TS ARC microphone input, 1 x USB type-B (service use only), AC POWER socket
- **Power requirement:** 90 to 240 V AC, auto-ranging, 50 or 60Hz, 120W max power consumption
- **Dimensions (inches):** 264mm/(10.39") x 160mm/(6.3") x 130mm/(5.12")
- **Weight :** 2.5kg (including tilting base)

Graphics

- **Frequency response**



- Phase

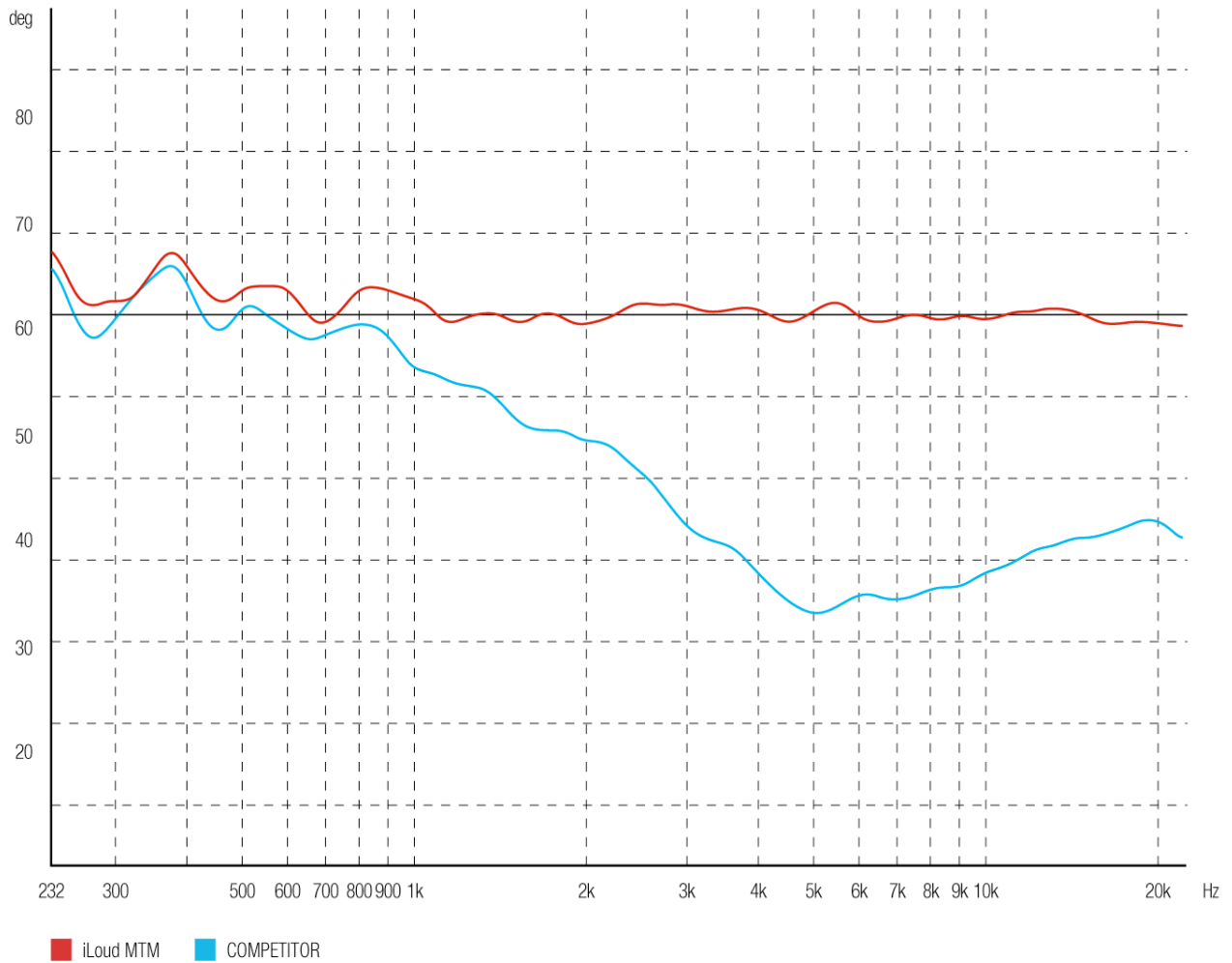

- IR graph

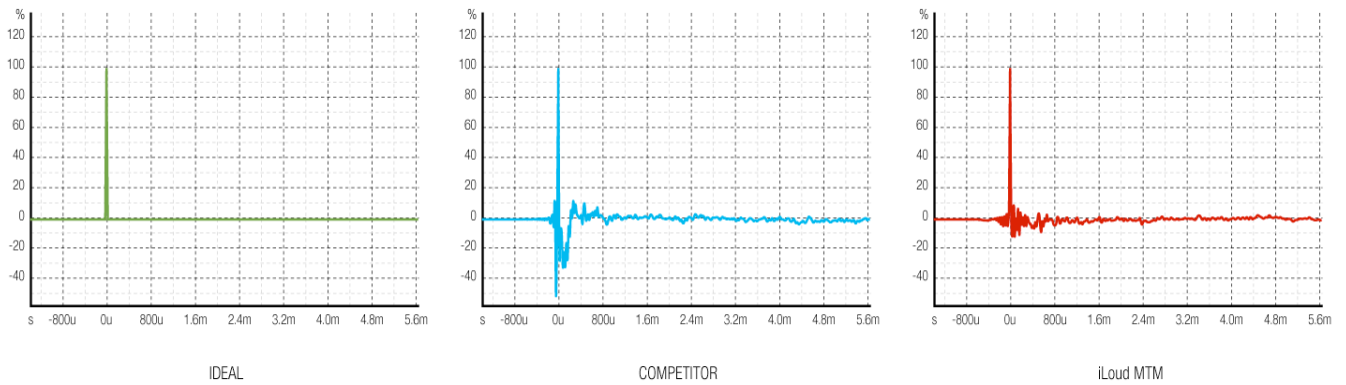

Warranty

Please visit:

www.ikmultimedia.com/warranty for the complete warranty policy.

Support and more info

www.ikmultimedia.com/support

www.iloudmtm.com

Regulatory

Model: iLoud MTM
Model Number: IK0000100

U.S.A.



FCC statement

This device complies with Part 15.107 and 15.109 Class B of the FCC Rules CFR47: October 2010. Operation is subject to the following two conditions:

1. This device may not cause harmful interference.
2. This device must accept any interference received, including interference that may cause undesired operation.

Changes or modifications not expressly approved by the party responsible for compliance could void the user's authority to operate the equipment.

EUROPE



AUSTRALIA/NEW ZEALAND



JAPAN



CHINA



iLoud® MTM is a trademark or registered trademark property of IK Multimedia Production Srl. All other product names and images, trademarks and artists names are the property of their respective owners, which are in no way associated or affiliated with IK Multimedia.