

Vena II Play

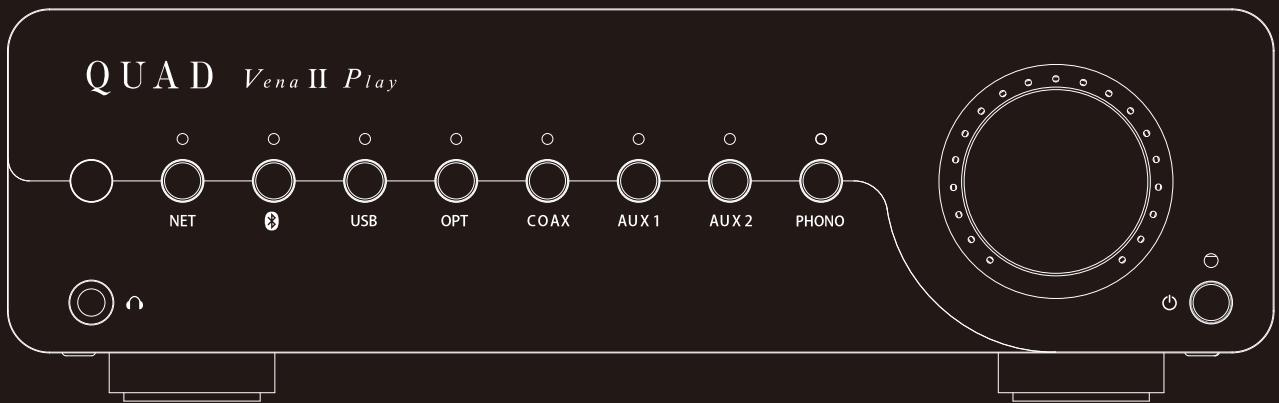

Wireless Streaming Integrated Amplifier

User Manual

QUAD

the closest approach to the original sound

IMPORTANT SAFETY INFORMATION



This lightning flash with arrowhead symbol within an equilateral triangle is intended to alert the user to the presence of non-insulated "dangerous voltage" within the product's enclosure that may be of sufficient magnitude to constitute a risk of electric shock.

Warning: To reduce the risk of electric shock, do not remove the cover (or back) as there are no user-serviceable parts inside. Refer servicing to qualified personnel.

This exclamation point within an equilateral triangle is intended to alert the user to the presence of important operating and maintenance instructions in the literature accompanying the appliance.

Read these instructions.

Keep these instructions.

Heed all warnings.

Follow all instructions.

Do not use this apparatus near water.

Clean only with dry cloth.

Do not block any ventilation openings. Install in accordance with the manufacturer's instructions.

Do not install near any heat sources such as radiators, heat registers, stoves, or other apparatus (including amplifiers) that produce heat.

Do not defeat the safety purpose of the polarized or grounding plug. A grounding plug has two blades and a third grounding prong. The wide blade or the third prong is provided for your safety. If the provided plug does not fit into your outlet, consult an electrician for replacement of the obsolete outlet.

Protect the power cord from being walked on or pinched particularly at the plugs, convenience receptacles, and at the point where they exit from the apparatus.



Use only with the cart, stand, tripod, bracket, or table specified by the manufacturer, or sold with the apparatus. When a cart or rack is used, use caution when moving the cart/apparatus combination to avoid injury from

tip-over.

Unplug this apparatus during lightning storms or when unused for long periods of time.

Refer all servicing to qualified service personnel. Servicing is required when the apparatus has been damaged in any way, such as power supply cord or plug is damaged, liquid has been spilled or objects have fallen into the apparatus, the apparatus has been exposed to rain or moisture, does not operate normally, or has been dropped.

WARNING: Only use attachments/accessories specified or provided by the manufacturer (such as the exclusive battery etc.).

WARNING: The mains plug/appliance coupler/is used as disconnection device; the disconnection device shall remain readily operable.

CAUTION: These servicing instructions are for use by qualified service personnel only. To reduce the risk of electric shock, do not perform any servicing other than that contained in the operating instructions unless you are qualified to do so.

Do not install this equipment in a confined or built-in space such as a bookcase or similar unit, and keep well ventilated in open space. The ventilation should not be impeded by covering the ventilation openings with items such as newspaper, table-cloths, curtains etc.

WARNING: To reduce the risk of fire or electric shock, do not expose this apparatus to rain or moisture. The apparatus shall not be exposed to dripping or splashing and ensure that objects filled with liquids, such as vases, shall not be placed on the apparatus. No naked flame sources, such as lighted candles, should be placed on the apparatus.

WARNING: Do not ingest the battery, Chemical Burn Hazard. (Supplied with the remote control.) This product contains a coin/button cell battery. If the coin / button cell battery is swallowed, it can cause severe internal burns in just 2 hours and can lead to death. Keep new and used batteries away from children. If the battery compartment does not close securely, stop using the product and keep it away from children. If you think batteries might have been swallowed or placed inside any part of the body, seek immediate medical attention.



Ground protection terminal. This product should be connected to a power outlet with ground protection.

Denmark: Apparatets stikprop skal tilsluttes en stikkontakt med jord, som giver forbindelse til stikproppens jord.

Finland: Laite on liitettävä suojakoskettimilla varustettuun pistorasiaan.

Norway: Apparatet må tilkoples jordet stikkontakt.

Sweden: Apparatens skall anslutas till jordat uttag.



This product will generate certain heat during use. Please pay attention to the hot surface.

WARNING: No naked flame sources, such as lighted candles, should be placed on the apparatus.

WARNING: Attention should be drawn to environmental aspects of battery disposal.

WARNING: Use of the apparatus in tropical climates.

QUAD

Vena II Play

CONTENTS

INTRODUCTION	4
UNPACKING THE EQUIPMENT.....	4
USB DRIVERS (AND FIRMWARE UPDATES)	4
PLACEMENT	4
CONTROLS AND FUNCTIONS	5
OUTPUT CONNECTIONS	8
INPUT CONNECTIONS	10
REMOTE HANDSET	11
DTS PLAY-FI® WIRELESS STREAMING TECHNOLOGY	14
DOWNLOAD THE APP	15
WI-FI CONNECTION USING THE APP	16
WI-FI CONNECTION SETUP USING A WINDOWS PC OR MAC	18
APP OPERATION	20
SPECIFICATIONS	26



The Bluetooth® word mark and logos are registered trademarks, owned by Bluetooth SIG, Inc. and any use of such marks by IAG Group Ltd is under license. Other trademarks and trade names are those of their respective owners.



aptX® software is copyright CSR plc. or its group companies. All rights reserved.

The aptX® mark and the aptX logo are trademarks of CSR plc. or one of its group companies and may be registered in one or more jurisdictions.

INTRODUCTION

Thank you for your investment in the QUAD Vena II Play. We are sure that the Vena II Play will continue to delight you for years to come.

The QUAD Vena II Play is designed to be the perfect match for all of your music sources and provides the necessary amplification to realise the highest quality of your music, regardless of the source.

You can link the Vena II Play to both analogue and digital sources, thanks to its diversity of inputs. A built-in phono pre-amp offers turntable connectivity. An innovative aptX codec provides CD quality audio over Bluetooth® connection. You can also make use of wireless audio streaming and multi-room systems with the built-in DTS Play-Fi technology.

With DTS Play-Fi® Technology, music can be streamed over your wireless network in high resolution format and can be easily expanded to an ultimate multi-room system, if required. You can stream from any source on your wireless network, including smart-phones, tablets or PCs as well as a NAS Drive.

Please read this manual carefully to discover all the ways you can connect your equipment to the QUAD Vena II Play and learn how to get the best performance from all of your music sources.

UNPACKING THE EQUIPMENT

The carton contains:

- The QUAD Vena II Play
- One IEC mains cable with a plug suitable for your area
- Three antenna cables
- One remote controller
- One QUAD Vena II Play user manual

Consult the dealer from whom you purchased the equipment if any item is not present. Carefully unpack the unit and accessories. Take care not to damage the surface finish when undoing the protective polythene sleeve. Retain the packing materials for future use. Retain the user manual and information concerning the date and place of purchase of your equipment for future reference. If you transfer the unit to a third party please pass on this instruction manual along with the equipment.

USB DRIVERS (AND FIRMWARE UPDATES)

To download Windows Drivers, please see the separate manual. Any firmware updates will also be available from www.quad-hifi.co.uk

PLACEMENT

The unit must be mounted on a solid, level and stable surface. Before you connect the QUAD Vena II Play to AC mains power, ensure your AC mains voltage corresponds to the rating on the rear panel of the product. If in doubt, consult your dealer. If you move to an area which has a different mains voltage, seek advice from a QUAD appointed dealer or a competent service technician.

CONTROLS AND FUNCTIONS

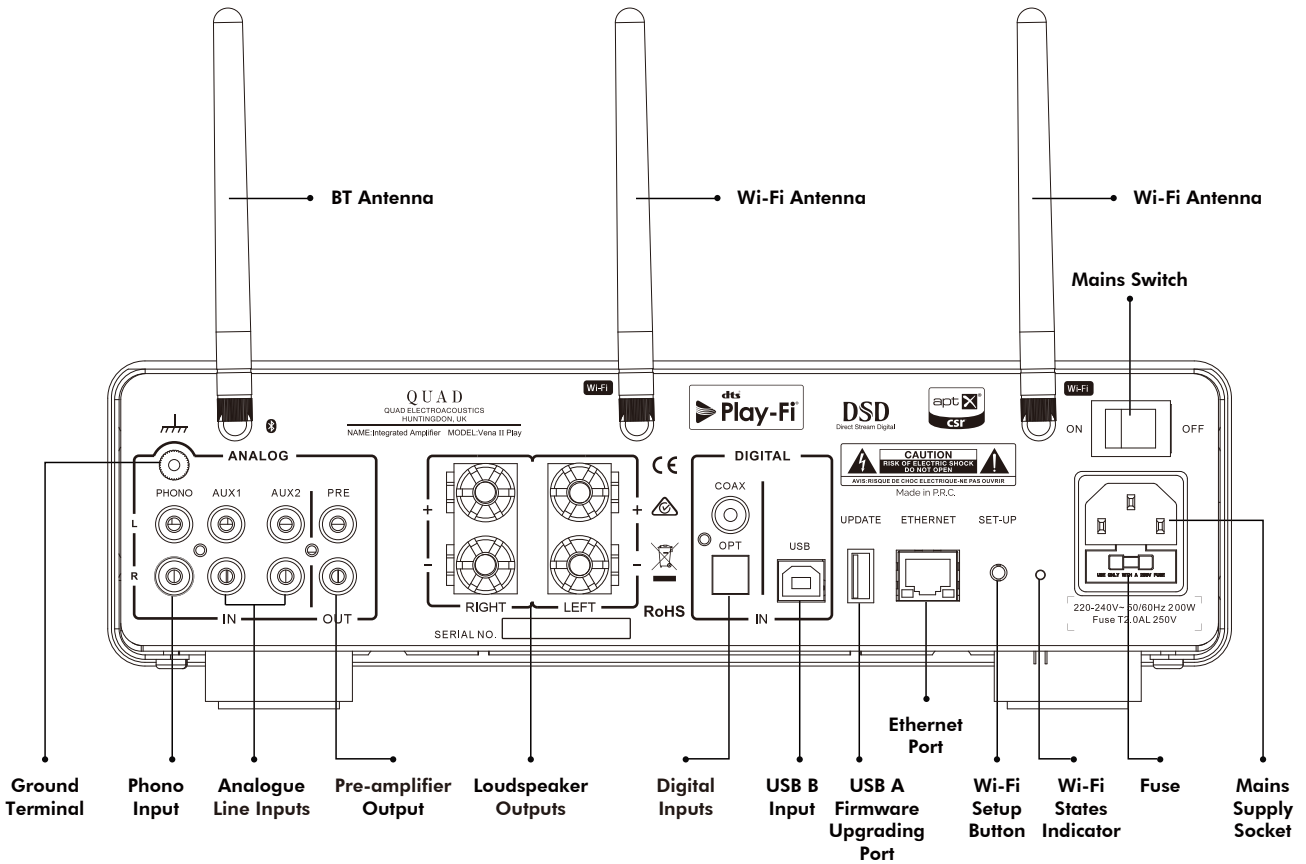
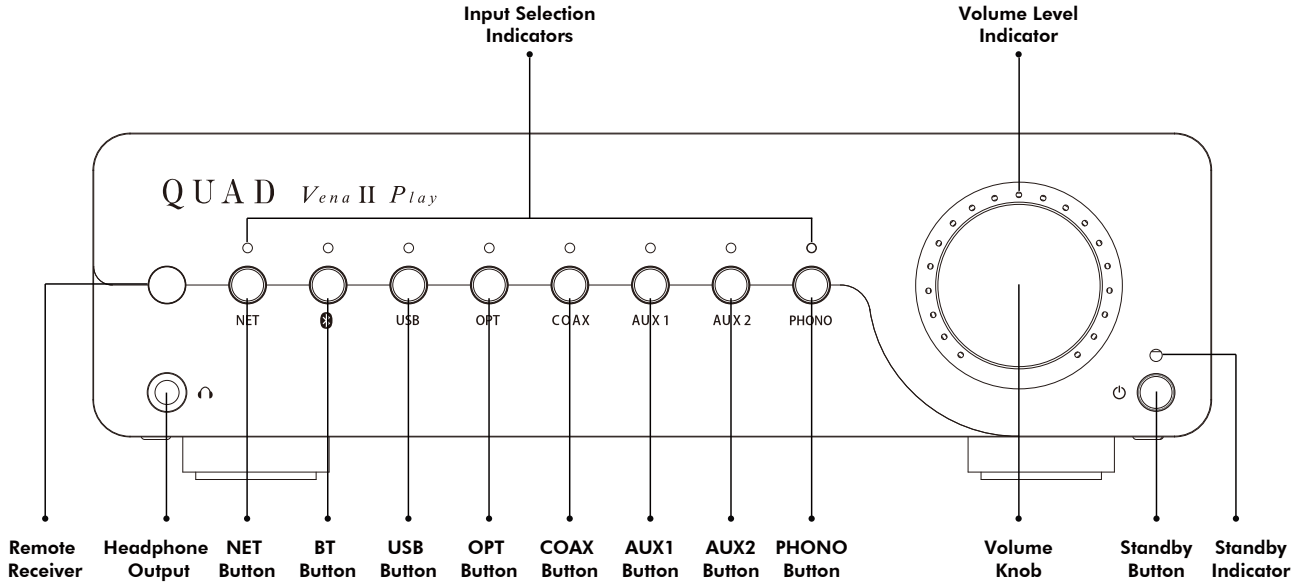

INSTALLATION

Before making any connections to your high fidelity equipment make sure that all units in the system are switched off and unplugged at the mains.

Mains Connections

The Mains On/Off switch is on the rear panel. Before connecting your QUAD equipment to the AC mains supply check and make sure the voltage marked on the back matches your supply voltage.

Analog Signal Output Connections

Preamplifier Output

Vena II Play has one pair of unbalanced RCA outputs which can make Vena II Play operate as a preamplifier.

Connect an RCA cable between the unbalanced pre output of Vena II Play and the unbalanced input of a power amplifier or associated equipment. Interconnectors should be of low-noise construction and fully screened to minimize hum and noise transmission.

Loudspeaker Outputs

Vena II Play has two sets of loudspeaker outputs. They are independent for right and left stereo amplifier outputs.

Connect the Positive (+) RED terminals of the amplifier to the Positive (+) RED terminals of the loudspeakers. Connect the Negative (-) BLACK terminals similarly. When connecting loudspeakers tighten the terminals securely by hand. Make sure there are no loose strands of wires which could cause short circuits.

Headphone Output

Vena II Play has a stereo 6.3mm(1/4") jack on the front panel for connecting headphones. Connecting headphones mutes the audio signal to the loudspeakers. Vena II Play headphone output can be set up to 4.5V, users can select suitable output levels to suit their headphones.

WARNING: Listening to music at high volume levels and for extended durations can damage one's hearing. In order to reduce the risk of damage to hearing, one should lower the volume to a safe, comfortable level, and reduce the amount of time listening at high levels. Headsets should comply with EN 50332-2 requirements (for GS certification).

NET Button

Activates DTS Play-Fi mode for wireless audio streaming and APP control.

Volume Knob

You can rotate the volume knob clockwise to increase the volume, rotate it counter-clockwise to decrease the volume. Press it once to mute the volume then press twice to un-mute the volume.

Volume Indicator

The volume level indicators have two states: brightly lit and off. To switch between the states, press and hold the volume knob for 4 seconds. In the 'off' state, the indicators will light for 5 seconds once the unit is activated, then go off. 'Off' is the default state.

Standby Button

Press the Standby button briefly to enter/exit the Standby mode.

Hold and press for 4 seconds to enter auto-standby set-up mode. (Please refer to page 12 to enable this function)

USB A Firmware Upgrading Port

This port must only be used to upgrade the internal firmware of Vena II Play. It cannot be used to connect a computer or USB disc to play music.

Ethernet Port

QUAD Vena II supports wired connection to your network music source. Connect the Ethernet Port to the LAN Port of a wireless router using a suitable cable. We recommend you use the wired network to play high resolution files without interruption or instability.

Set-up Button

Use the setup button to help set up your WiFi connection. Press and hold it for 4 seconds to enter the WPS network set-up mode. Press and hold for up to 8 seconds to enter the standard network set-up mode. Press the button again to cancel the WPS network set-up mode.

OUTPUT CONNECTIONS

Artera Play

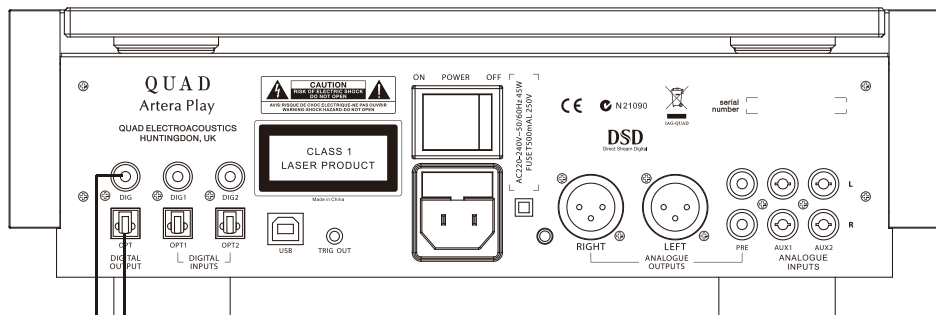

Loudspeaker Right

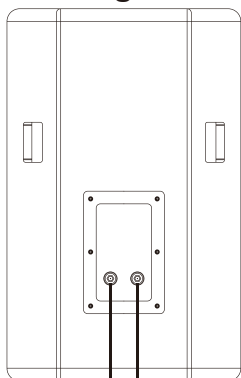

Loudspeaker Left

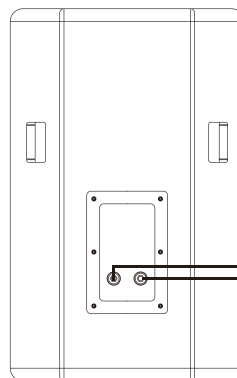

QUAD Vena II Play

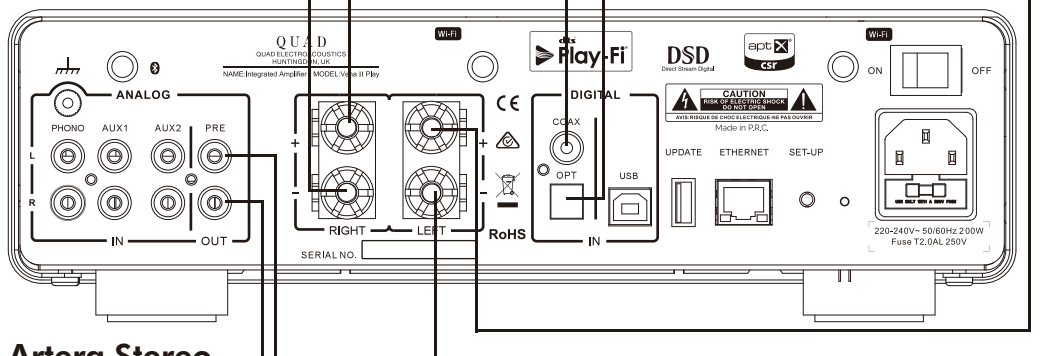

Artera Stereo

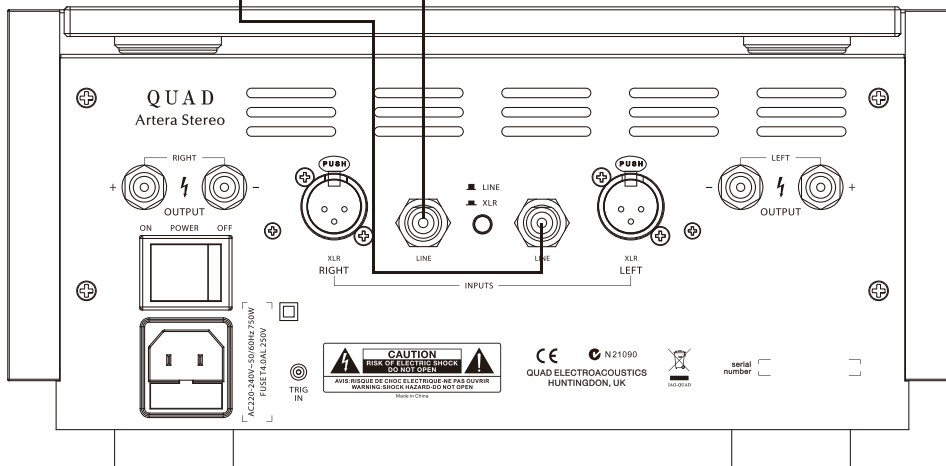

Analog Signal Input Connections

Vena II Play has two sets of unbalanced RCA inputs for connection to sources which provide line level outputs. Both sets are identical.

Connect an RCA cable between the unbalanced input of Vena II Play and the unbalanced output of a source unit like a CD player or DAC. Interconnections should be of low-noise construction and fully screened to minimize hum and noise transmission.

PHONO Signal Input Connections

Vena II Play has a PHONO signal input, the PHONO input should only be connected to turntables fitted with MM or high output MC cartridges.

Digital Signal Input Connections

Vena II Play has a variety of digital inputs, which can be connected to most popular digital sources, like the digital output of a CD or DVD player, DAC, PC.

Coaxial Input

Vena II Play has a coaxial SPDIF input. Connect an RCA digital interconnection between the digital coaxial output of the source unit to the COAX input of Vena II Play.

Optical Input

Vena II Play has an optical SPDIF input. Connect an optical (TOSlink) interconnection between the digital optical output of the source unit to the OPT input on Vena II Play.

Bluetooth Input

Vena II Play has a built-in Bluetooth signal processor module which can play audio files transmitted from the source unit via Bluetooth wireless transmission. Please refer to page 13 to enable this function.

USB Input

Vena II Play has one B-type USB input which lets you connect a Mac or PC to play audio files stored on a computer.



B-type USB

INPUT CONNECTIONS

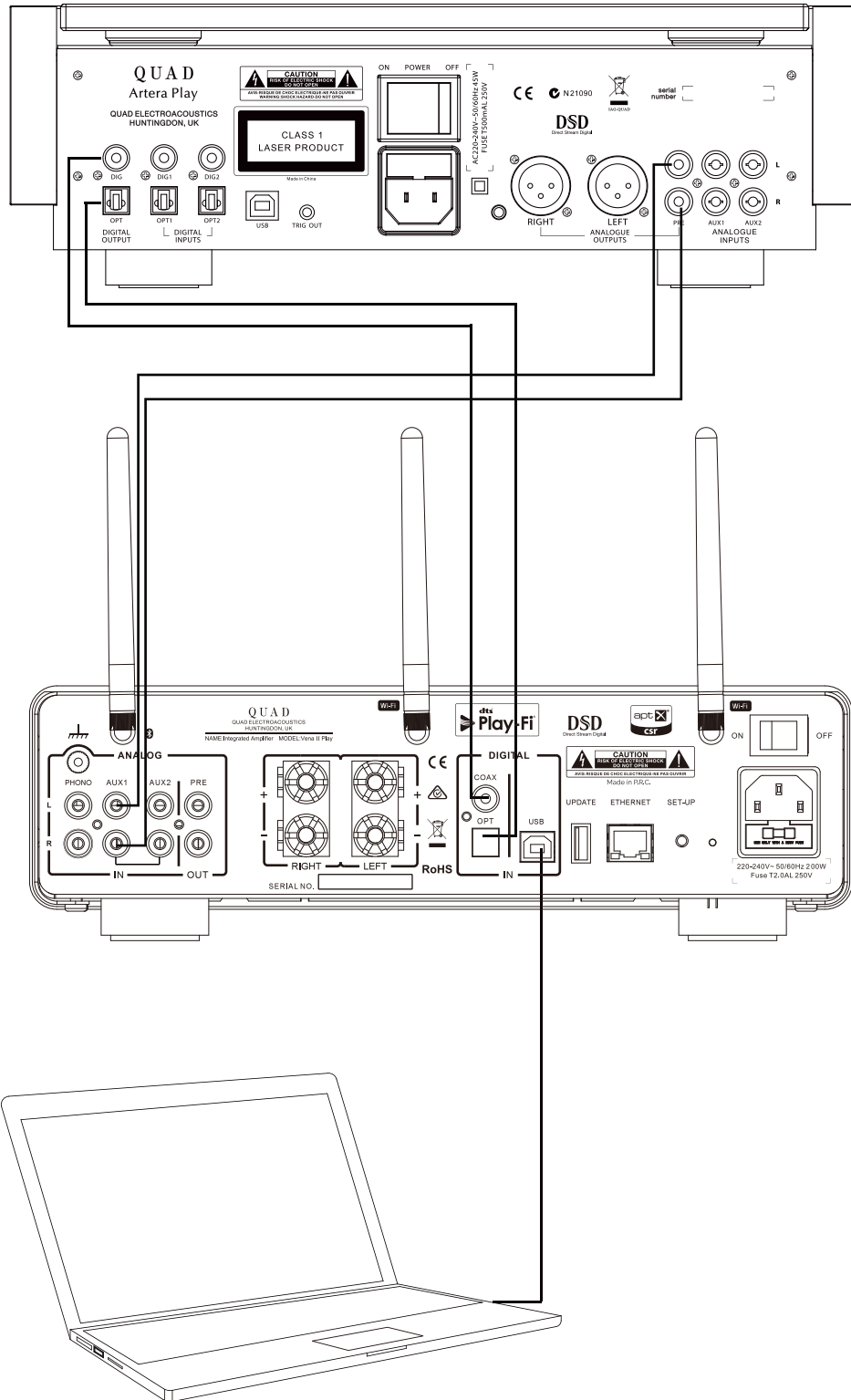

REMOTE HANDSET

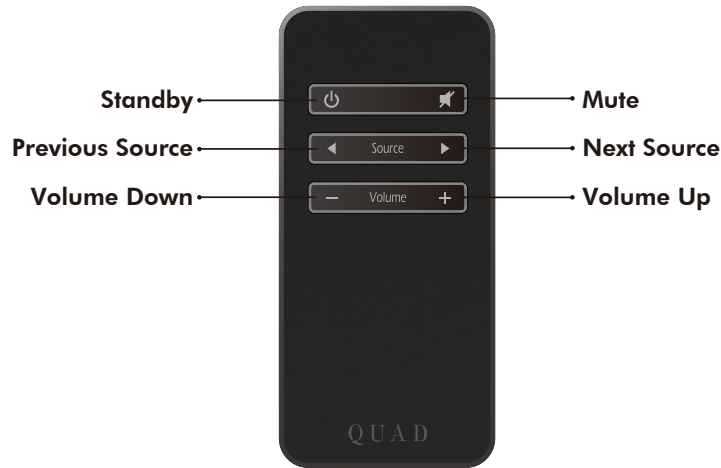

Press to bring product in/out of Standby mode



Press to Mute/Unmute the sound. In Mute , the volume indicator on the front panel will flash



Press to select Previous Source



Press to select Next Source



Press to increase volume



Press to decrease volume

Remote Controller Preparation

- Unpack the handset
- Invert the handset
- Remove the battery cover
- Insert a new battery
- Close the battery cover

Cautions About Battery Cautions

To prevent any burning, fire, or any possible harm to the environment or human health from the depleted batteries, please correctly dispose of the waste batteries in light of the recycling rules in your area. Don't dismantle, crush or puncture the batteries. Never short-circuit the batteries, throw the batteries into the water or fire or even try to repair them. The battery only can be changed with CR2025.

OPERATION

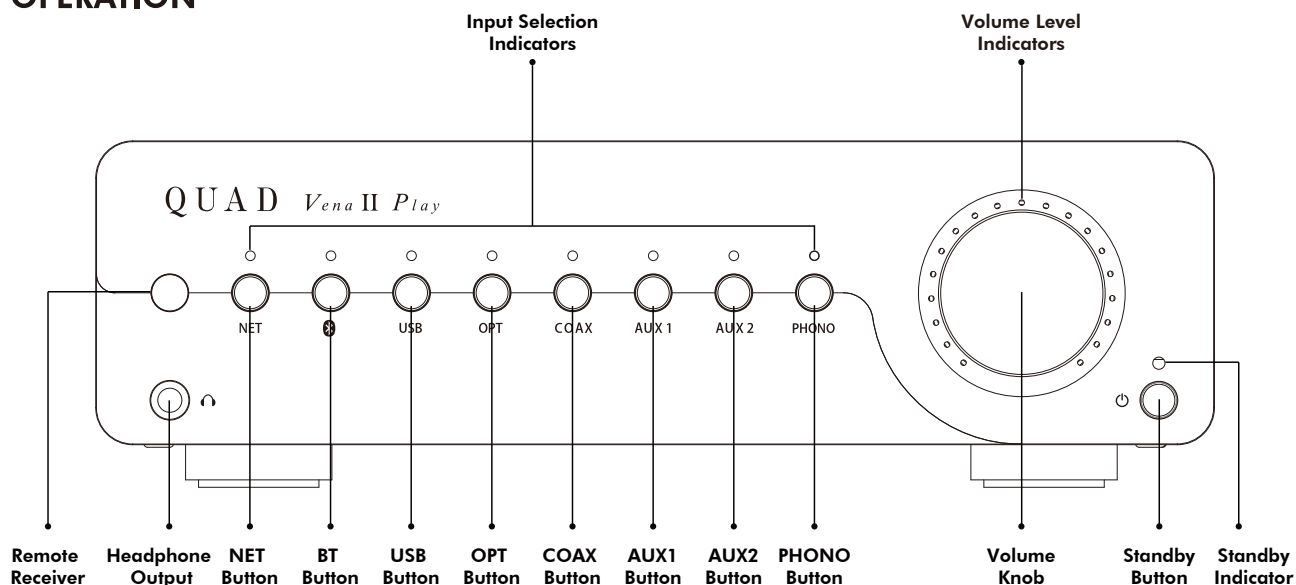

Standby Mode

Vena II Play will be in standby mode when powered on. The  indicator on front panel is lit. Press  button to bring Vena II Play out of standby.

You can activate the 'auto standby' function, as follows, by holding the  button down for 4 seconds.

The Standby indicator flashes once: Auto-Standby Never. QUAD Vena II Play will not go into Standby mode even if there is no signal input or operation.

The Standby indicator flashes twice: Auto-Standby 20 minutes. QUAD Vena II Play will automatically go into Standby mode if there is no signal input or operation for 20 minutes.

The Standby indicator flashes thrice: Auto-Standby 1 hour. QUAD Vena II Play will automatically go into Standby mode if there is no signal input or operation for 1 hour.

Protection Mode

Vena II Play is protected by a thermal switch which interrupts the AC Power supply if the amplifier is grossly overloaded for a period of time. To restore operation, simply press the  button on the front panel. It is thus fully protected against gross overload, short-circuited output etc, but not necessarily against seriously inadequate ventilation.

Mute Mode

Users can press the remote handset button  or press the volume knob to bring Vena II Play in or out of Mute mode when playing music. When muted, the volume indicator on the front panel will flash.

Combination Keys Function

PHONO+NET: Restore Factory Defaults

Synchronously hold and press the buttons "NET and PHONO" for 8 seconds, the Standby LED will flash twice with a warning tone. Then Vena II Play will automatically restore the factory defaults and restart.

PHONO+Volume: Power-on Volume Limit Set-up

To protect the speakers from being damaged by excessive volume, Vena II Play allows you to set up the volume limit value when powered on.

Synchronously hold and press the buttons "PHONO and Volume" for 4 seconds, release them when the volume indicator flashes. Now you can set up the Power-on volume limit value by rotating the volume knob, then press the knob once to confirm the set-up, the indicator will be stably lit.

You can set up any volume from Min. level to Max. level depending on your need. If Vena II Play was switched off with the volume level above the set-up value, the set-up volume defaults to be played when the unit is next switched on. If Vena II Play was switched off with the volume level below the set-up value, the volume will keep the same when the unit is next switched on.

Playing Music via Analog Inputs

Connect the analog signal of a source unit to Vena II Play's AUX1 or AUX2 input. Press AUX1 or AUX2 button on the front panel. AUX1 or AUX2 indicator will be lit and music will start playing.

Playing Music via Digital Inputs

Connect coaxial SPDIF signal of source units to the digital in COAX jack on Vena II Play's panel. Press COAX button on the front panel.

Connect optical (TOSLink) signal of source units to Vena II Play's OPT jack on Vena II Play's rear panel. Press OPT button on the front panel.

Playing Music via USB input

Connect a Mac or PC via the B-type USB interface on Vena II Play's panel. Press USB button on the front panel. USB indicator will be lit, and then click play on your music player software to play audio files stored on your computer.

Playing Music via Bluetooth

You can wirelessly connect Vena II Play to a music source via Bluetooth wireless technology. Volume up/down, standby and mute in/out can be controlled from either your Bluetooth source or from Vena II Play. Other functions-play, pause, previous track, next track, fast forward and reverse are all controlled from your Bluetooth source only.

Establishing a Bluetooth Connection

1. Place Vena II Play and a Bluetooth music source within a few meters of each other.
2. Power on Vena II Play and select Bluetooth as the source. The Bluetooth source indicator will flash when in pairing mode.
3. Activate the Bluetooth function on your music source.
4. Select "Quad Vena II Play" when Vena II Play is found to start the pairing process.
5. If prompted for a password, enter "0000".

To play music

Select Vena II Play as a music output device on your Bluetooth source to start playing music.

Disconnecting

To disconnect the Bluetooth music source either:

- Move the Bluetooth source beyond the communication area
- Turn off the connected device or turn off its Bluetooth function
- Hold and press the BT button for 3 seconds to disconnect the BT compulsorily

Note:

If you have difficulty connecting Vena II Play to a Bluetooth device, please try selecting "Forget this Device" on your source unit and then go through the connection procedure again.

Playing Music Via DTS Play-Fi

You can stream music from multiple sources via the DTS Play-Fi functionality of the Vena II Play. See the following pages for more information about DTS Play-Fi and the world of music sources which you can connect and enjoy via the Quad Vena II Play.

DTS PLAY-FI® WIRELESS STREAMING TECHNOLOGY

Key Features

DTS Play-Fi puts you in complete control of your music. It gives you the freedom to effortlessly stream via Wi-Fi® from any device to any speaker in any room in your house. It's never been easier to listen to music with the people you love, in the place you love most. A place that memories are made and music plays the starring role.



WI-FI®TECHNOLOGY

DTS Play-Fi streams music over standard Wi-Fi networks, delivering perfectly synchronized audio, with no lag and zero loss in sound quality.

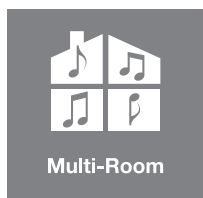

MULTI-ROOM

Enjoy music in every room of your house — all at once, perfectly synchronized, with no lag. You're in control.

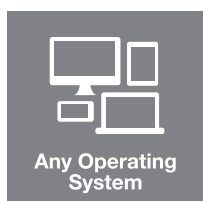

ANY OPERATING SYSTEM

Fully compatible with all operating systems: Apple iOS, Android™, Windows® PC, and Fire OS.



MULTI-SPEAKER

DTS Play-Fi is open to all speakers, no matter the size, shape, or brand. It's a truly all-inclusive system.

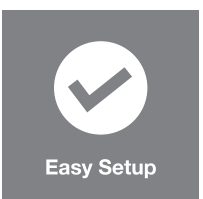

EASY SETUP

No logins, no complicated computer-based setups. Just download the APP and within minutes, you're ready to listen.



DTS PLAY-FI APP

Simply download the free APP and immediately send songs via Wi-Fi to any speaker in any room of the house.

For DTS patents, see <http://patents.dts.com>. Manufactured under license from DTS Licensing Limited. DTS, Play-Fi, the Symbol, and Play-Fi together in combination with the Symbol are trademarks of DTS, Inc. DTS and Play-Fi are registered trademarks of DTS, Inc. © DTS, Inc. All Rights Reserved.

DOWNLOAD THE APP

The DTS Play-Fi APP can be downloaded from the Google Play Store, Amazon APP Market or Apple App Store. For Windows PC you can download the Play-Fi Windows APP from the official website: <https://play-fi.com>



Network Settings

Wired network setting

Connect the Ethernet Port to the LAN port of a wireless router using a suitable cable. After switching on the Vena II Play, the white NET LED on the front panel and red Wi-Fi LED on the rear panel will flash during the initialize phase of Wi-Fi mode. The white NET LED will slow-flash when the device goes into the wired network connection. If the connection is successful, the red Wi-Fi LED will go off, but the white NET LED stays lit.

Wireless Network Setting

You can connect to a wireless network using one of two modes: WPS Mode or Standard Mode.

WPS Mode:

In order to make the Vena II Play enter WPS Mode, switch the unit on and press and hold the Wi-Fi SET-UP button on the rear panel for 4 seconds. The Wi-Fi LED will double-flash and beep with a warning tone indicating that WPS Mode is active. Then briefly press the WPS key on your wireless router and the unit should connect to your wireless network automatically. This connection phase may take up to 60 seconds. If the connection fails, please try again. However, if the unit has failed to enter WPS Mode for 2 minutes, the unit will convert into Standard Mode.

Standard Mode:

After switching the Vena II Play on, press and hold the Wi-Fi SET-UP button on the rear panel for 8 seconds. For the first 4 seconds the Wi-Fi LED will double-flash and beep with a warning tone - keep holding the button down and after 8 seconds the Wi-Fi LED will flash quickly and also beep with a warning tone. The Standard connection mode is now active and the Wi-Fi hotspot will be found after 20 seconds. Then the Wi-Fi LED will flash-breathe with a slow fluctuation between off and on (reflected by the white LED on the front panel). You can now use your Android or IOS device to enter the Wi-Fi password using the Play-Fi APP as follows (see next page):

WI-FI CONNECTION USING THE APP

For Andriod users:

- (1) Open the DTS Play-Fi APP, then click the 'Set-up your Play-Fi device' button.
- (2) When it has found the Vena II Play click the 'Set-Up'. Next input the Wi-Fi password for your wireless network. Then click the 'Next' button.
- (3) During installation the APP will find and update the Vena II Play Play-Fi settings to the latest version, this may take a few minutes.
- (4) After completing the network set-up and update, you can set a name for your Vena II Play device and begin enjoying the wireless streaming functionality.



For Apple iOS users:

(1) Download the Play-Fi APP. Before opening the APP please switch to the Settings - Wi-Fi menu on your smartphone or tablet and select 'PlayFiXDeviceXXXXXX' from the options.

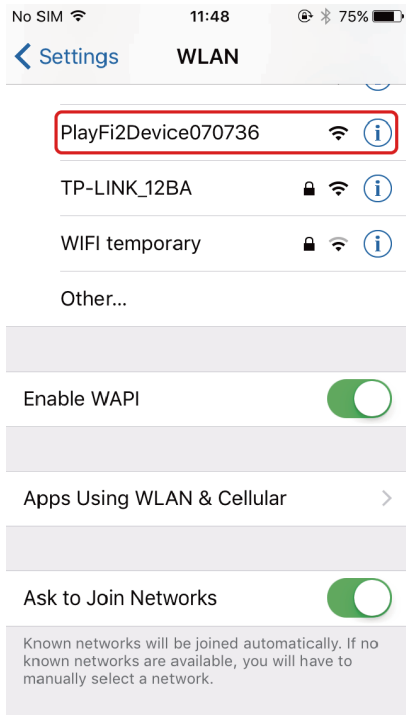

(2) Open the Play-Fi APP and find the Vena II Play Play-Fi Device name. Select it and enter your wireless network password.

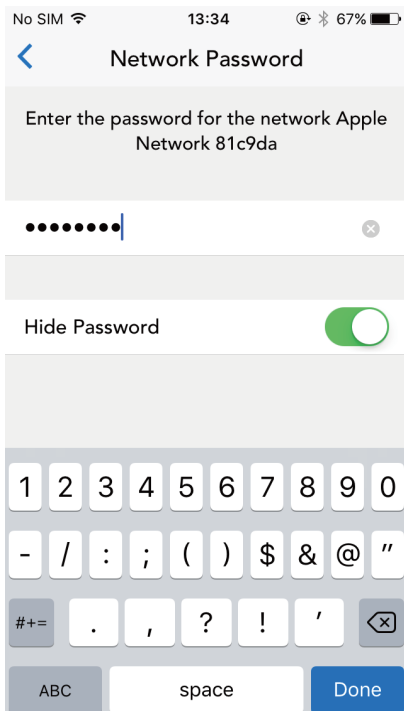

(3) During installation the APP will find and upgrade the Vena II Play Play-Fi settings which may take a few minutes.
(4) After completing the network set-up and upgrading you can set a name for your Vena II Play Device and use it.

WI-FI CONNECTION SETUP USING A WINDOWS PC OR MAC

For PC or Mac users:

If you cannot connect to use the Play-Fi APP, or you need to do some high-level options such as setting the static IP configuration, you can setup the Vena II Play using a web browser from your Windows PC or a Mac.

Set the Vena II Play to Standard Set-up mode, then follow these steps:

- (1) Connect your computer to the wireless Wi-Fi of the Vena II Play - it will show like 'PlayFi2Device000XXXXXX' or similar name. After connecting your computer may show 'No Internet Connection' - this is normal.
- (2) Open your Internet Browser and type: 192.168.0.1/index.html in the address bar.
- (3) Click the Enter key or click 'Continue' option in your Internet Browser.
- (4) This will open the Play-Fi configuration.
- (5) Select the 'Set Up' button.

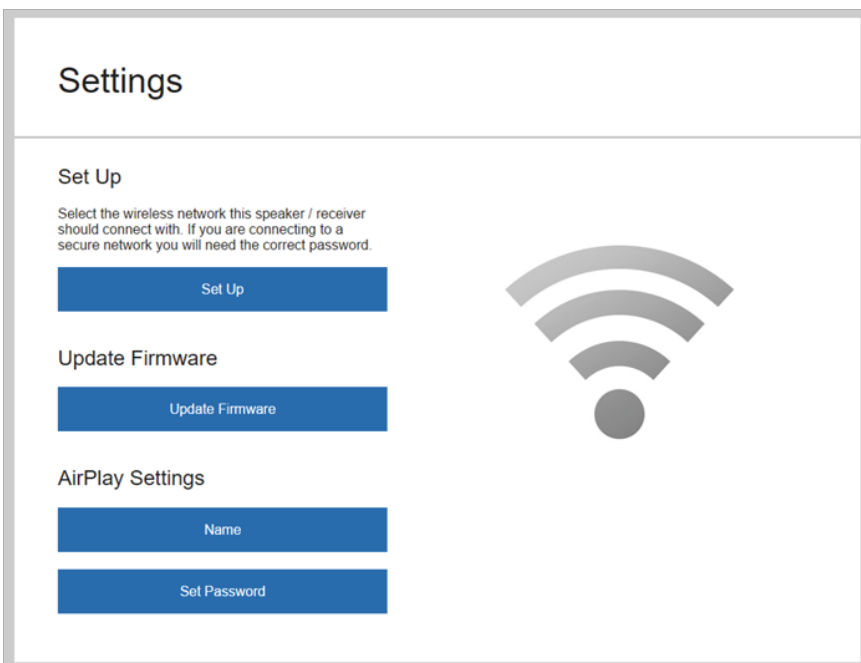

- (6) Select your wireless router Wi-Fi network.



(7) Enter the password for your wireless network. Then click the 'NEXT' button.

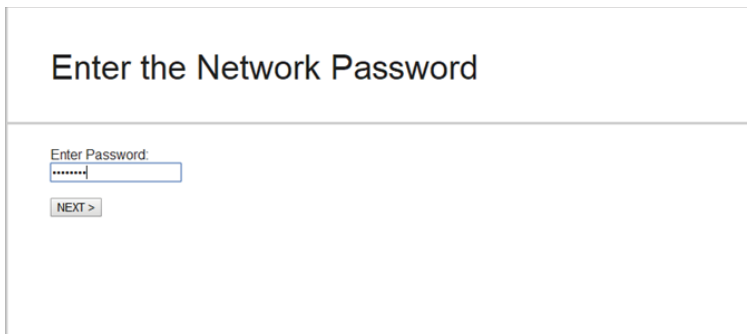

The screenshot shows a web-based interface for entering a network password. At the top, the title "Enter the Network Password" is displayed in a large, bold, black font. Below the title, there is a label "Enter Password:" followed by a text input field containing seven dots, indicating that the password is hidden. Below the input field is a button labeled "NEXT >" with a right-pointing arrow.

(8) You can then name your Vena II Play Device and click 'NEXT'. The Wi-Fi connection will be made and you can use the device.

APP OPERATIONS

Device Selection

The DTS Play-Fi APP allows you to control and direct streaming music to a variety of devices throughout your home that use the DTS Play-Fi system. The streaming music also can be played by Spotify Connect and DLNA. You can set each device to have a unique name. You can also group devices into an Area, where each device will play the same music.

After connecting the network, open the DTS Play-Fi APP, click the '+' icon on the upper right corner of the APP display. Select an Area to add, then select a device on which to play the music. If you wish to play high-resolution audio files, the icon 'Hi-Res AUDIO' should be selected.

Music Services

DTS Play-Fi supports the world's most popular and exciting streaming music services, so you can enjoy your favorites at home just as easily as you do in the gym. See below for more information of streaming music service platforms. Please feel free to choose one you like.

(Note: some streaming music service platforms probably need to be registered.)

Amazon Music

Amazon Prime members can use Amazon's popular music service for free. A growing selection of over 2 million songs is always ad-free and on-demand, with curated playlists, personalized stations and unlimited skips. Upgrade to Prime Music Unlimited, and enjoy 10 million songs, weekly new releases, and more.



Deezer

With 43 million tracks, 100 million playlists, and a presence in 182 countries, Deezer literally covers the globe for its subscribers. Subscriptions start at \$9.99/month, and include ad-free playback, premium audio quality, and more.



iHeartRadio

iHeartRadio combines access to over 1,500 of the most popular live terrestrial and internet radio stations with unique live events and compelling custom features, like artist radio, personalized radio, and on-demand podcasts for FREE. Their new Plus and All-Access subscriptions allow you to pause, rewind, skip and save live radio content, stream on-demand music, and more.



Internet Radio

DTS Play-Fi has a built-in Internet Radio service that gives you access to thousands of radio stations and podcasts from around the globe. Instantly see your local favorites, or tune into the BBC, ESPN, Radio Disney, the Wall Street Journal, and more. Browsing is a snap, and if you find a station you love, just give it a star and it'll be ready to stream whenever you are. Free, no subscription required.



Juke

With more than 20 million tracks and a dedicated base of music fans, Juke's streaming service includes popular features like on-the-go playlists, new music discovery, and ad-free listening. DTS Play-Fi is the only multi-room audio platform to offer the Juke service.



KKBox

KKBox is Asia's leading streaming music service, with over 30 million tracks from 500 local and major labels, and the most comprehensive collection of Asia-Pop in the world. Featuring both free and premium options, the service also includes mood-based programming and supplemental content including music news, videos, concert updates and more.



On Device Music

DTS Play-Fi puts your mobile music collection at your fingertips, automatically finding and indexing the songs stored on your device. You can browse and stream by album, artist or genre, and even use your existing playlists. DTS Play-Fi supports local files in multiple formats, from MP3 all the way up to premium CD and lossless quality encoding. Free, with no subscription required.



Media Server

Got a hard drive full of music? Avid digital collectors can access and stream from media servers using DTS Play-Fi. The system automatically discovers and indexes music from DLNA and UPnP servers on your network. You can select and stream files in multiple formats via DTS Play-Fi, including premium tracks encoded at CD quality or even 24-bit/192kHz lossless content. No subscription required.



Napster

Napster integrates the heritage of streaming market pioneer Rhapsody into its premium, ad-free on-demand service. With 30 million tracks, instant playlist creation, and anytime, anywhere access, Napster is justifiably popular on multiple continents with millions of subscribers.



Pandora

Listen free to music you'll love, as Pandora's streaming service evolves with your tastes. Give songs a thumbs up or down, and your stations become more personal the more you listen. Enjoy the service at no charge with ads, upgrade to Pandora Plus for commercial-free streaming, or try Pandora Premium to add on-demand features and premium sound quality to your experience.



Qobuz

Based in France, Qobuz was founded and built around a premium audio quality experience. It boasts 70,000 albums available for streaming at 24/192, with many more streaming at 16/44 CD quality. The service also features in-depth artist profiles and editorial content.



QQMusic

China's largest music streaming service offers tens of millions of tracks and thousands of radio stations to its 400 million monthly active users. With free and premium tiers, and both local and international content, QQ Music is a dominant force in music listening in China.

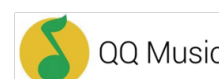

SiriusXM

With over 150 channels of commercial-free music plus sports, talk, comedy, entertainment, news and more, it's no wonder that Sirius XM is one of the most widely used premium streaming services in North America. It's a snap to go from listening in your car to listening at home with DTS Play-Fi.



SoundMachine

Business never sounded so good! Whether it's in an office or a restaurant, a retailer or a hotel, background music enhances both the customer and the employee experience. Hundreds of stations and millions of songs, including the ability to create artist stations, so you can design the perfect sound for your brand. Fully licensed for business environments.



Spotify

Spotify transformed music listening forever when it launched in Sweden in 2008. Discover, manage and share over 50m songs for free, or upgrade to Spotify Premium to access exclusive features including offline mode, improved sound quality, Spotify Connect and ad-free listening. Today, Spotify is the most popular global audio streaming subscription service with 217m users, including 100m subscribers, across 79 markets. We are the largest driver of revenue to the music business today.



The Spotify Software is subject to third party licenses found here:
www.spotify.com/connect/third-party-licenses.

Use your phone, tablet or computer as a remote control for Spotify. Go to spotify.com/connect to learn how.

Tidal

High Fidelity Music Streaming is Tidal’s hallmark. Every track on the service streams in premium audio format, with most in lossless CD quality or above. The service also boasts many exclusive new releases, artist-curated stations and in-depth features designed to complement the music offerings. Available to DTS Play-Fi users in the US and more than 50 other countries.



In addition to the support listed above, it also supports music services such as BBC, ESPN RADIO, HD tracks, NPR, tunein and so on, and there will be more music platforms involved in the development.

DISCLAIMER: Not all music services are available in all regions and countries.

Line In Mode

The Vena II Play supports wireless broadcasting of any of your music source inputs to other DTS Play-Fi audio solutions on your network. For instance, you can stream the turntable input from your VENA II PLAY to other DTS Play-Fi wireless speakers or streamers via the app. Perfect for a multi-room home audio solutions.

To activate this mode simply click the icon “+” on the top right corner of DTS Play-Fi App, select “Line In”, then select the source unit, source channel and music genre. Finally select the secondary audio output device to which you wish to broadcast and click “Start Line In Broadcast” to play.

Note: there should be at least 2 or more than 2 units of DTS Play-Fi system supporting to use this function. The Broadcast mode can support all the input channels except the Bluetooth functionality.

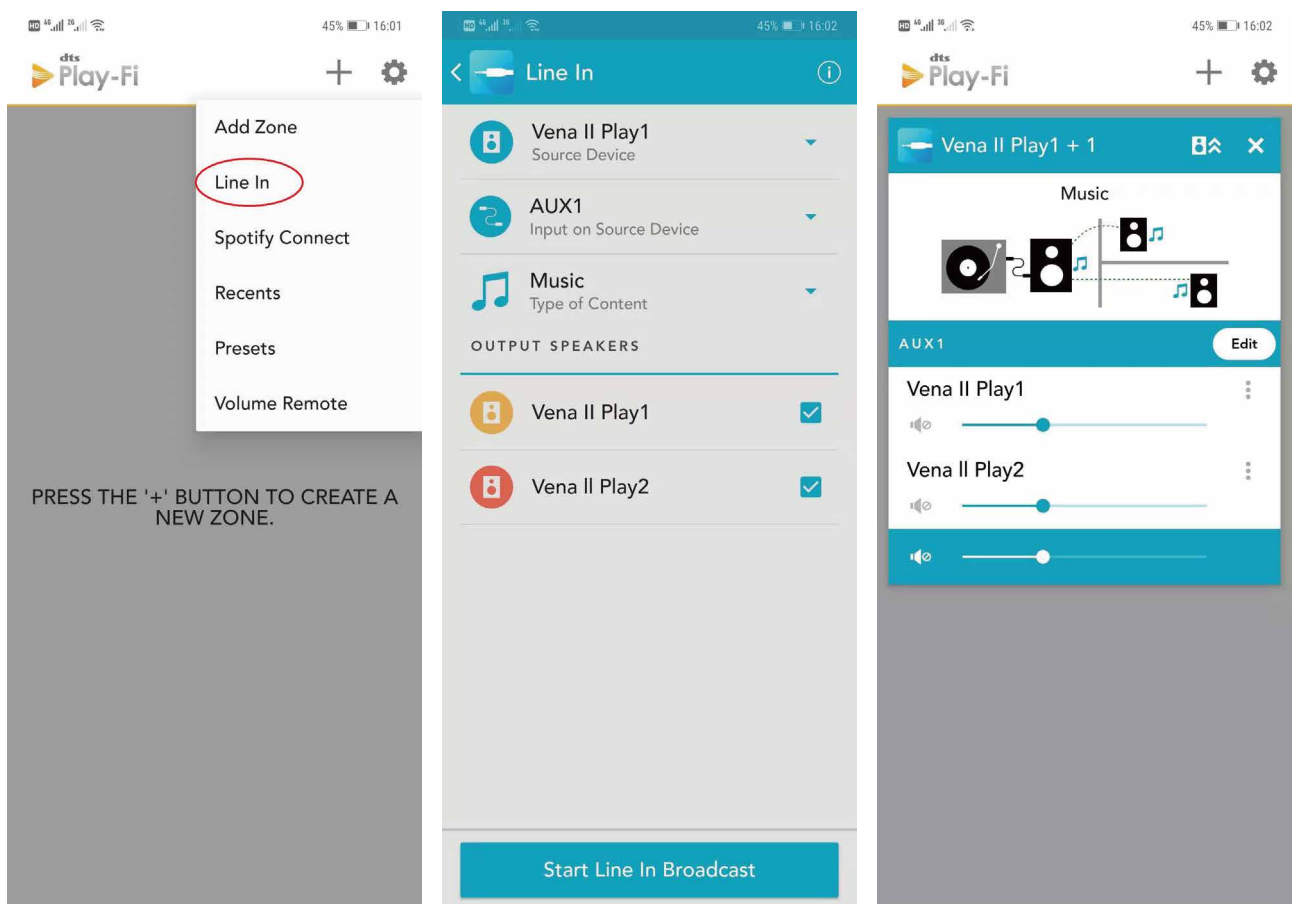

Speakers Group

To stream music from Vena II Play to multi-room Devices such as DTS Play-Fi Speakers, open the DTS Play-Fi APP, find the Device or Speaker, give it a name and then add it.

To delete the Device or Speaker, just click on the right side of the Device name and then delete.

Currently it is not recommended to wirelessly stream Hi-Res audio to speakers if you want stable, uninterrupted playback.

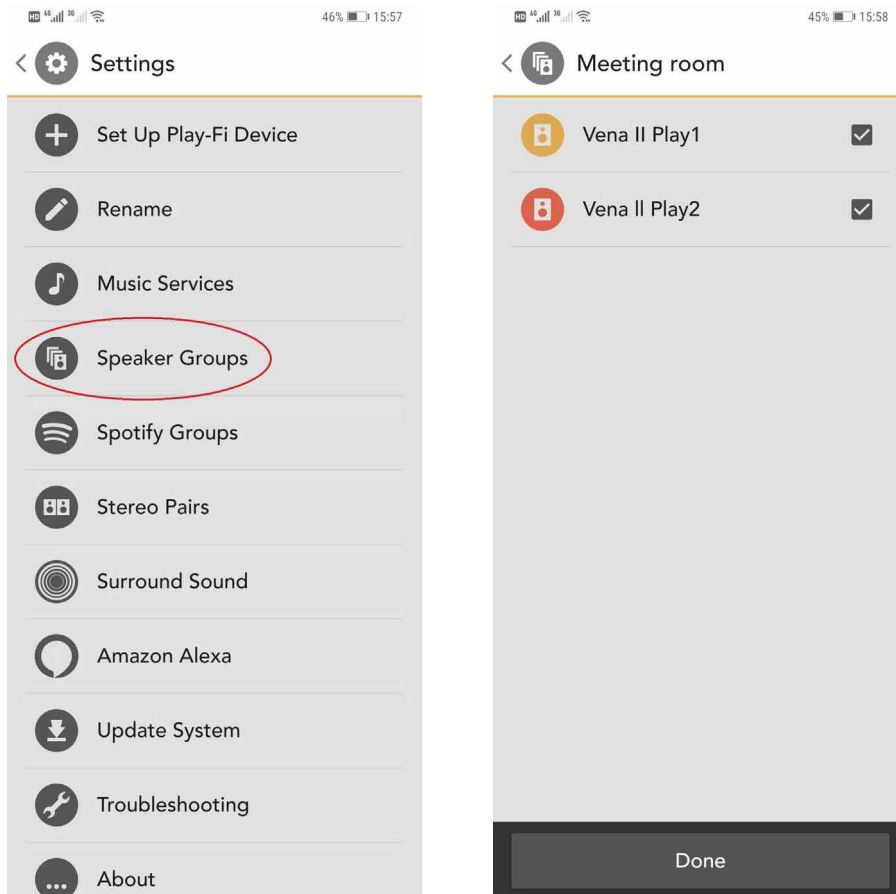

Spotify Group Setup

Open the Set Up of the DTS Play-Fi app and click the Spotify Group. Create a new group and name for it, then select any Play-Fi products you want to add into this group (on the right side). Any speakers that can't be added to the Spotify Group will show in grey. Any speakers that can't be joined to a Spotify Group will be greyed out. Once you're satisfied, head to the Spotify app to start streaming.

Surround Sound

So far, QUAD Vena II Play cannot support the play of "Surround Sound", "Amazon Alexa" and "Airplay". For the common problems in utilization and fault diagnosis, you can open the APP settings to find the "Fault diagnosis", then enter the DTS Play-Fi website knowledge base which has the detailed information.

Update System

If there is an update available, click "Update System" and the process will carry on automatically. Click "About", you can see the DTS Play-Fi's APP version and the status of network connection, IP address and versions of the module software and MCU. For 'Advanced Settings' you can choose from various options - the default mode is recommended.

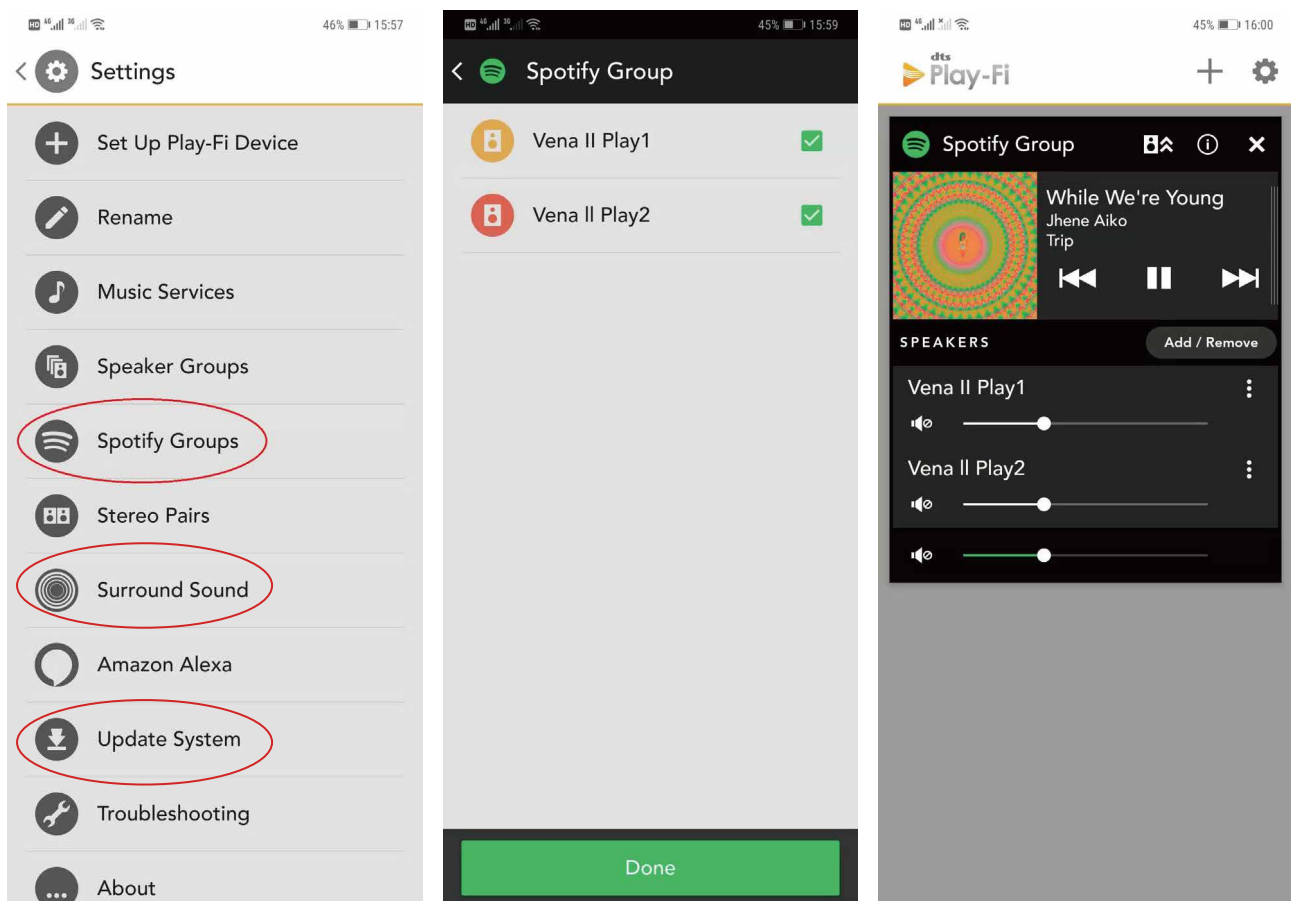

DTS Play-Fi Windows Application

In your PC of Windows 7,8, 8.1, or 10, DTS Play-Fi windows application allows you to stream any audio source like the APP servers or Websites, which includes Spotify, Google Play, iTunes, Xbox Live, etc.

Music Play Mode: recently the Music Play Mode is only suitable for the free version. After you select the Music Mode, then select the Vena II Play speaker to play.

Video Play Mode: upgrade this mode to be a high-grade version, purchasing a licensed key to activate the high-resolution DTS Play-Fi. The videos and Vena II Play audios both can be played synchronously throughout the high-resolution DTS Play-Fi. Click the option "Video Play Mode" then select the speaker to play. A variety of videos, such as YouTube, Windows media player, etc, are available with the high-resolution DTS Play-Fi.

The high-resolution DTS Play-Fi is the unique feasible scheme that contains high-grade encoder, decoder and proprietary QoS (Service Quality) technology to realize the Wi-Fi streaming play and provide the amazing audio accuracy even if in the busiest network.

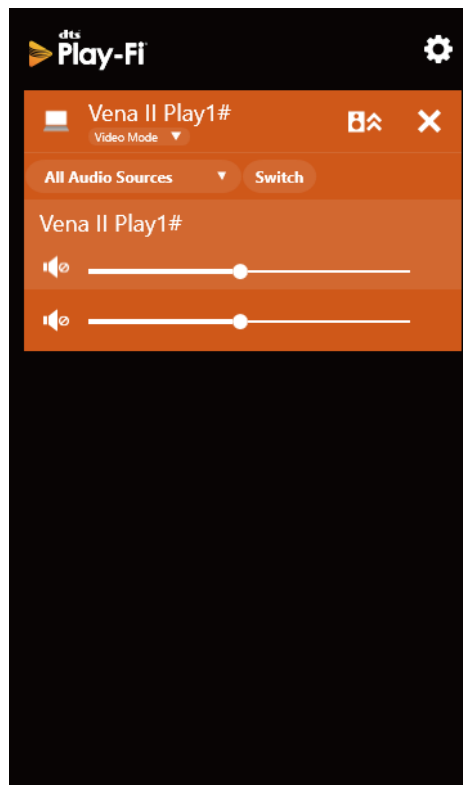
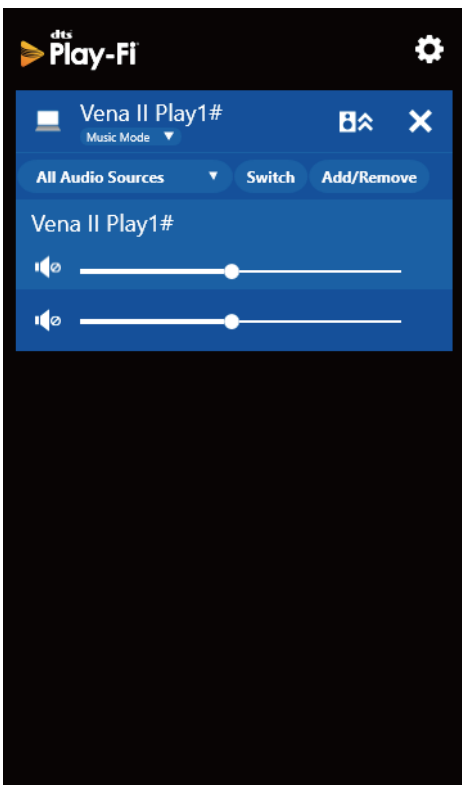

SPECIFICATIONS

Model	Vena II Play
DTS Play-Fi Technology	Dual - band 802.11a/b/g/n Support global, popular streaming content (Amazon Music, Spotify, TIDAL, Juke, BBC, ESPN, KKBox, SiriusXM, Napster, Internet Radio, Deezer, iHeartRadio, PANDORA, SOUNDMACHINE, tunein, Qobuz, Qmusic) Support Speakers Group Support android/iOS/Kindle Fire/Windows PC
Analogue Pre-Amplifier Section:	
Input Sensitivity (AUX)	525mV
Input Sensitivity (Phono, MM)	2.5mV
Input Impedance	10Kohm (AUX) , 47Kohm // 100pF (Phono)
Inputs	2 x AUX , 1x Phono (MM)
Output	1 x Pre-Out (RCA)
Frequency Response	20Hz-20KHz (+/- 0.5dB)
Total Harmonic Distortion (THD)	< 0.002%
Signal To Noise	> 110dB (A-Weighted)
Power Amplifier Section	
Rated Power	2 x 45W (8ohm) / 2 x 65W (4ohm)
Frequency Response	20Hz-20KHz (+/- 0.5dB)
Total Harmonic Distortion (THD)	< 0.005% (30W, 8ohm)
Signal To Noise	> 108dB (A-Weighted)
Digital Section	
DAC	ESS Sabre32 ES9018K2M chip
Sampling Frequency	Optical, coaxial: 44.1kHz ---192kHz ; USB:44.1kHz---384kHz(PCM)/DSD64, DSD128, DSD256 Ethernet, Wi-Fi: 44.1kHz ---192kHz
Digital Input	1 x Coaxial, 1 x Toslink Optical 1 x USB for PC USB Bluetooth(aptX, aptX LL)
Mechanical Section	
Size (W X H X D)	301 x 95 x 313 mm
Net Weight	6.1kg

Channel Indicators

The channel indicators indicate the current state of the channel you choose.

Channel Indicators	Device States	LED States
NET Indicator	Wi-Fi mode in initialization state	LED is fast-flash white
	WPS network set-up mode	LED is double-flash white
	Standard network setup mode	LED breathe white
	Connecting network	LED slow-flash white
	Wi-Fi /Wired Network connection	LED is bright white
BT Indicator	Spotify	LED is bright green
	BT disconnection	LED flash white
USB Indicator	BT connection	LED is bright white
	In the PC USB channel	LED is bright white
OPT Indicator	In the OPT channel	LED is bright white
COAX Indicator	In the COAX channel	LED is bright white
AUX1 Indicator	In the AUX1 channel	LED is bright white
AUX2 Indicator	In the AUX2 channel	LED is bright white
PHONO Indicator	In the PHONO channel	LED is bright white

Care And Cleaning

While cleaning is in progress the AC power cord must be unplugged from the AC power supply socket.

The surface of the equipment should be cleaned with a damp soft cloth. Solvent based cleaning materials should not be used as they may damage the finish.

If you have any queries regarding the use of QUAD equipment, consult your dealer.

Warranty

QUAD equipment is guaranteed against any defect in material and workmanship for a period of one year from the date of purchase. Proof of purchase is required for warranty claims.

Please complete and return the enclosed Warranty Registration Form. Within the warranty period QUAD will undertake replacement of defective parts free of charge provided that the failure was not caused by misuse, accident or negligence. Your statutory rights within the territory in which you purchased the equipment is not affected by this warranty.

QUAD carries out regular reviews and reserves the right to adjust the specifications and performance from time to time.

Servicing

Product service enquiries should, in the first instance, be referred to the supplying dealer. If you need to return your equipment for servicing we recommend that it is shipped in its original packing.

In cases of difficulty or for other product enquiries please contact that appointed QUAD distributor for your country. Principal Service Centre addresses and contact numbers can be found below.

For information of worldwide authorized service centres, please read worldwide distributor list on the QUAD website: www.quad-hifi.co.uk.

International Service Centre Address

IAG House, 13/14 Glebe Road, Huntingdon, Cambridgeshire, PE 29 7DL, UK

Tel: +44 (0) 1480 452561 Eml: service@quad-hifi.co.uk



Correct Disposal of this product. This marking indicates that this product should not be disposed with other household wastes throughout the EU. To prevent possible harm to the environment or human health from uncontrolled waste disposal, recycle it responsibly to promote the sustainable reuse of material resources. To return your used device, please use the return and collection systems or contact the retailer where the product was purchased. They can take this product for environmental safe recycling.

QUAD

IAG House, 13/14 Glebe Road, Huntingdon, Cambridgeshire, PE29 7DL, UK
Tel: +44(0)1480 452561 Eml: service@quad-hifi.co.uk <http://www.quad-hifi.co.uk>
IAG reserves the right to alter the design and specifications without notice. All rights reserved © IAG Group Ltd.
QUAD is a member of the International Audio Group.