

### Section 1 - Onyx Components

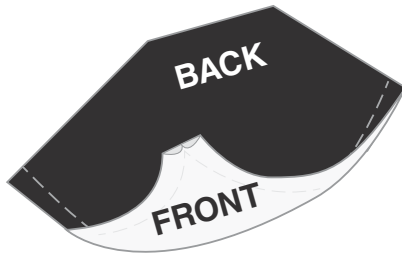

Viewing Surface - 1

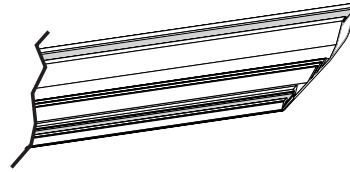

Frame Extrusions - 4



Corner Brackets  
w/Set screws - 8



1/8" Allen  
Wrench - 1



Surface Retention  
Extrusions - Several



Plastic Tubing - 4

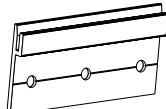

Wall Brackets - 2

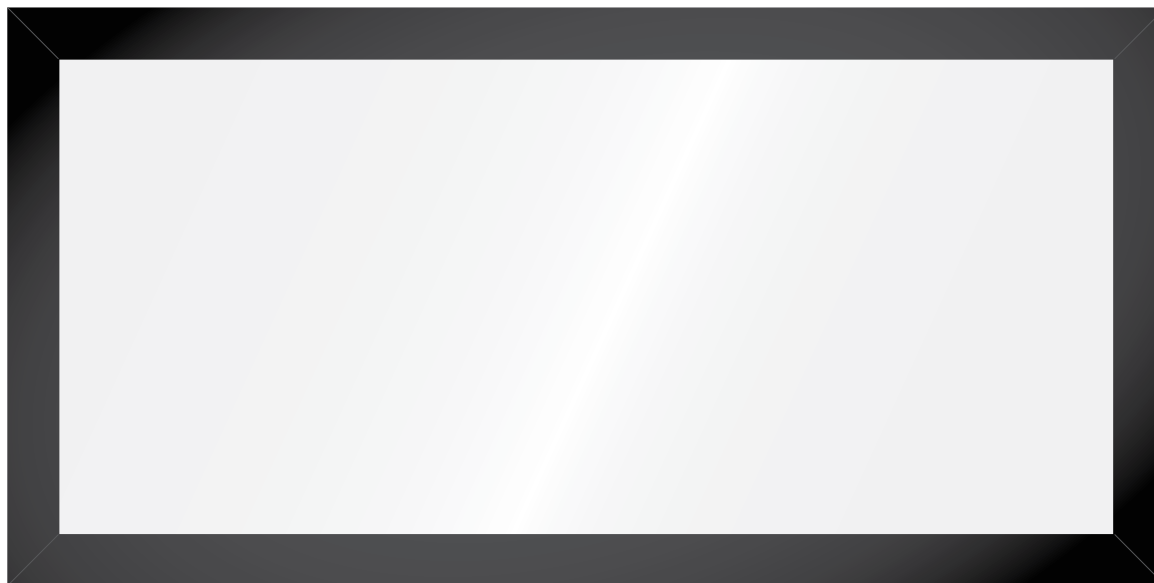

**Fully Assembled Onyx Projection Screen** - Front View

## CAUTION

1. Read instructions through completely before proceeding.
2. Follow instructions carefully. Installation contrary to instructions invalidates warranty.
3. Screen should be accessible for complete removal should surface become damaged or should other service be required.
4. Screen should be installed level (using a carpenter's level).
5. Nothing should be fastened to screen frame or viewing surface.
6. Make sure you have received all parts.
7. Draper recommends using two people for assembly and installation. When lifting assembled screen, do not lift at only one corner; lift at both corners. Lifting by one corner could result in damage to the screen frame, especially on large screens.
8. Installer is responsible for providing appropriate hardware for mounting.
9. The ideal temperature range for assembling permanently tensioned screens to prevent damaging the surface is 68° - 78° F (20° - 26° C). Assembling below recommended temperatures may damage surface and void warranty.
10. Use extreme care when handling TecVision surfaces. To prevent damaging the TecVision viewing surface, Draper strongly recommends using the provided white gloves.

**Please Note:**

Custom products/installations may not be reflected by this document. Call Draper, Inc. if you have questions about your installation.

### TOOLS REQUIRED



Pencil

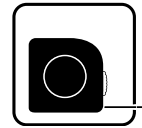

Tape Measure

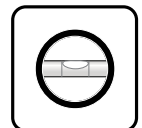

Level



Power Drill



Hardware (by Others)



White Gloves  
(TecVision Only)

## Section 2 - Frame Assembly

1. Clean area and place frame assembly pieces face down. Insert corner brackets into aluminum frame extrusions as indicated in Figures 1 through 4. For easier assembly insert the inner connectors first.
2. Make sure corner brackets are fully seated.
3. Secure corner brackets by tightening setscrews (see Fig. 4).

**Please Note:** If corner brackets do not slide into frame extrusions, make sure that setscrews are backed out enough to allow proper clearance.

The Onyx has a precision cut mitered corner.

**Please Note:** If corner gaps exist (painted frame only) readjusting the frame and/or applying a small bead of black silicone to fill the gap is the best solution. Apply a very small bead of black silicone to area where frame gap exists. Work silicone into gap (using your finger or a cloth). Remove ALL silicone on face of frame; only silicone inside gap should remain.

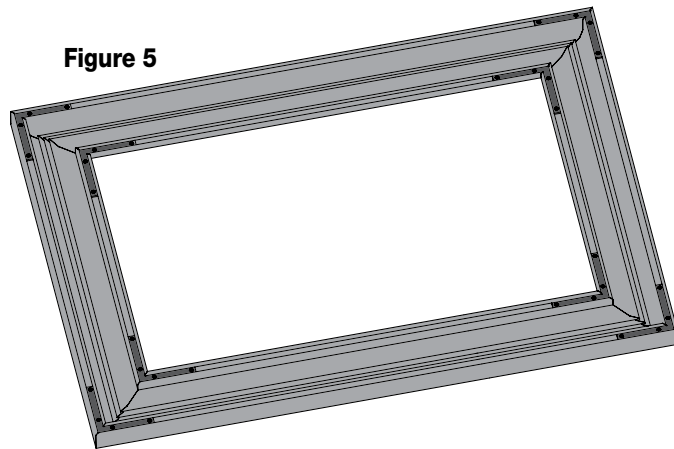

Figure 1

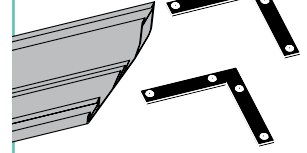

Figure 2

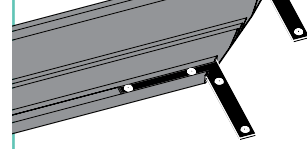

Figure 3

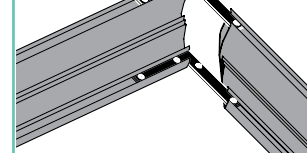
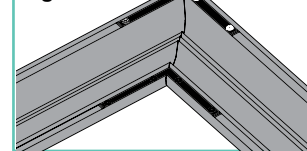

Figure 4



## Section 3 - Surface Preparation

1. Move frame assembly out of the way, unroll viewing surface and place on smooth/clean surface. (Position viewing surface so that folded side of hem is visible.)
2. Insert plastic tubing inside pocket formed by hem on all 4 edges of viewing surface (see Fig. 6).
3. Divide surface retention extrusions up so they will be evenly spaced all the way around the screen.
4. Carefully slide surface retention extrusions (rounded edge visible) along hem and onto surface on all 4 edges of surface (see Fig. 7).

**Caution:** Do not allow surface to snag on ends of extrusions. If the screen surface is not parallel with the surface retention extrusion, then it may slit and tear during installation.

**Please Note:** To make this step easier, pinch the end of the pocket closed before sliding it into the surface retention extrusions.

5. The top and bottom of the screen should have the same number of surface retention extrusions. The two sides should also have the same number (but fewer than the top and bottom). This will allow even spacing all the way around the screen.
6. Verify that all surface retention extrusions are installed with rounded edge visible and are centered on surface material.

Figure 6

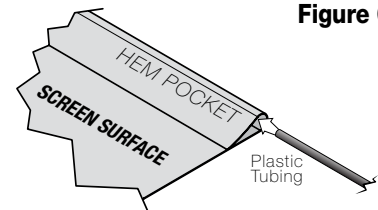
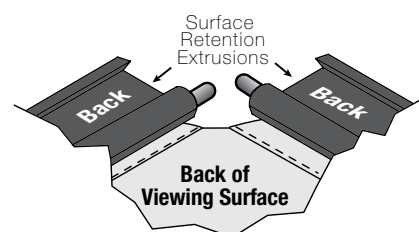
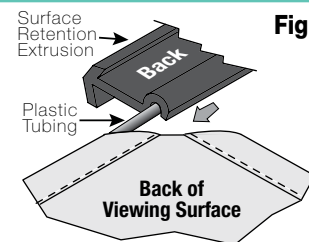

Figure 7



## Section 3 - Surface to Frame Assembly

1. Return frame onto clean surface, face down, and drape completed surface assembly over completed frame profile with rounded edges of surface retention extrusions visible.
2. Hook surface retention extrusions on any side of surface to notch #1 on corresponding side of frame extrusion (see Fig. 10).

**\*Please Note:** For proper tensioning, start in the center of the frame extrusion, and work your way out to the corners.

3. Repeat on opposite side of surface, again using notch #1.
4. Repeat steps 2-3 with remaining edges of surface.
5. Ensure surface retention extrusions are equally spaced in tension slots on all 4 edges of surface.
6. If additional tension in certain areas of the screen is desired, adjust surface retention extrusions to notch #2 or #3 as necessary.

**Please Note:** It is not necessary to adjust more than one edge at a time to increase surface tension.

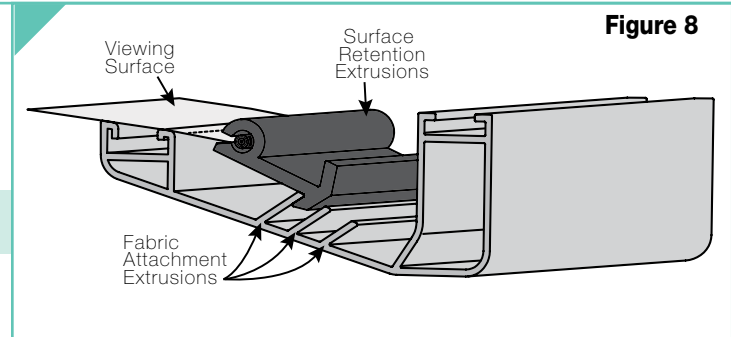
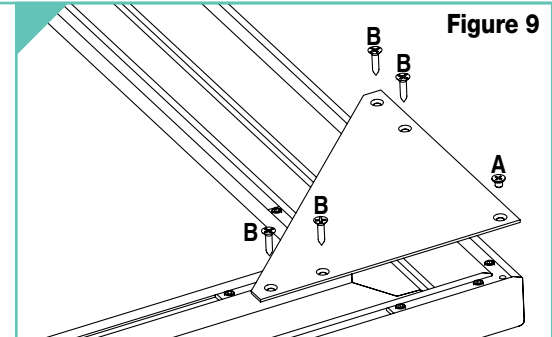

**Figure 8**

## Section 4 - Corner Reinforcement Kit (Part Number 253696)

A Corner Reinforcement kit is required for flown screens. Corner gussets may only be installed after screen is otherwise completely assembled (including surface).

1. Install frame per Onyx Instructions.
2. Align corner gusset plate to frame.
3. Install the supplied #10-24 x .250" fastener (A) into tapped hole in corner bracket.
4. Align corner gusset plate parallel with the outer edges of the frame.
5. Drill one hole through frame (using holes in gusset plate as a guide) with 1/8" or #30 drill bit.
6. Install one of the #8 x .750" self-threading fasteners (B) into the hole, and tighten completely to set the plate in position.
7. Drill the remaining three holes using the gusset plate as a guide.
8. Install the remaining three #8 x .750" self-threading fasteners (B) and tighten completely to set the plate in position.
9. Repeat the above steps on the remaining three corners of the screen.



**Figure 9**

## Section 5 - Onyx Frame Dimensions (Side View - Detail)

