

NEPTUNE 200 BEAM

USER MANUAL

 [®] NEPTUNE 200 BEAM
SS673

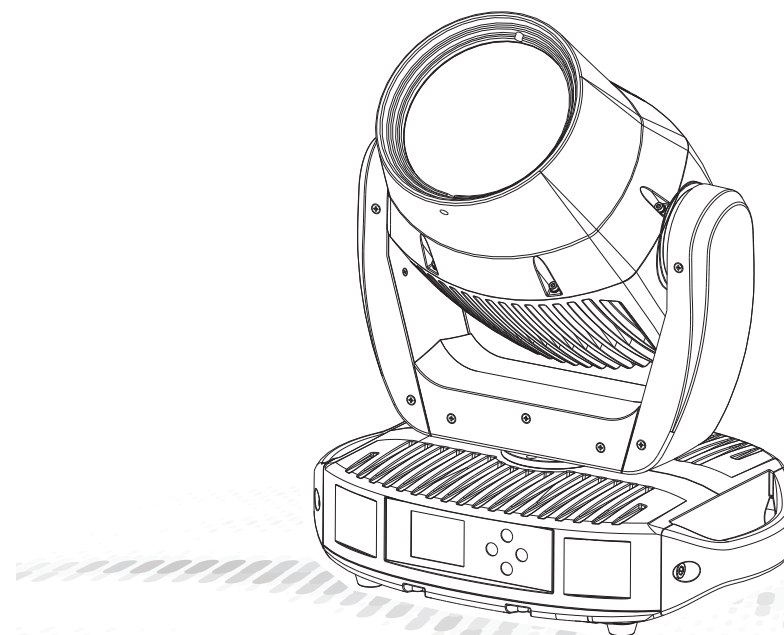

MODEL:SS673SCM



广州市雅江光电设备有限公司

Guangzhou Yajiang Photoelectric Equipment Ltd.

电话/Tel : 020-86947788 邮箱/E-mail : sales@yajiang.cn

传真/Fax : 020-86943773 网址/Website : www.yajiang.cn

— Since 1985 —

RD-SS673-SM-01(SS-1)

1 Product Introduction

1.1 Specification

| | |
|---------------------|------------------------|
| Product Code | SS673SCM |
| Dimension | 410 × 280 × 482(mm) |
| Weight | 22KG |
| Rated Power | 180W |
| Input Voltage | AC100~240VAC,50/60Hz |
| Frequency Range | 2.2A |
| Ambient Temperature | -20°C~45°C |
| Beam Angle | 1.7° |
| Control Model | DMX512/RDM/ArtNet/sACN |

| BASIC (12CH) | STANDARD (15CH) | EXTEND (18CH) | VALUE | FUNCTION |
|-----------------|--------------------|------------------|---------|-------------------------|
| | | | 221-230 | COLOR GOBO SYSTEM RESET |
| | | | 231-255 | PRISM FOCUS RESET |

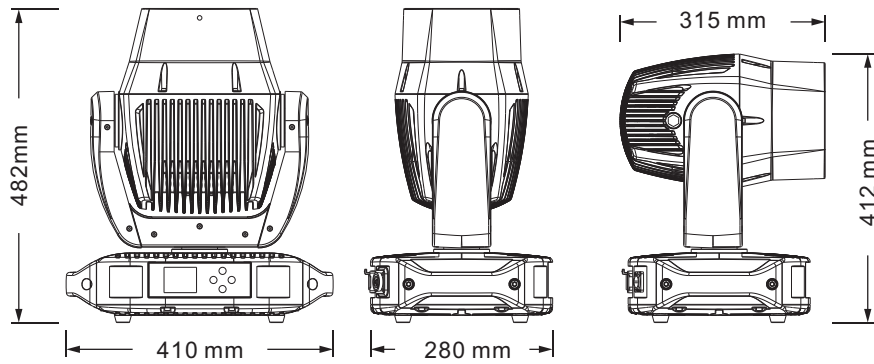

| BASIC (12CH) | STANDARD (15CH) | EXTEND (18CH) | VALUE | FUNCTION |
|--------------|-----------------|---------------|----------------|--|
| | | | 206-255 | PRISM INSERT AND REVERSE ROTATION (SPEED 1 → 100%) |
| CH.9 | CH.11 | CH.13 | 0-255 | FOCUS |
| - | - | CH.14 | 0-255 | FOCUS FINE |
| CH.10 | CH.12 | CH.15 | 0-255 | DIMMER |
| - | CH.13 | CH.16 | 0-255 | DIMMER FINE |
| CH.11 | CH.14 | CH.17 | STROBE | |
| | | | 0-9 | NO FUNCTION |
| | | | 10-99 | STROBE (FROM SLOW TO FAST) |
| | | | 100-109 | NO FUNCTION |
| | | | 110-179 | LIGHTNING STROBE |
| | | | 180-189 | NO FUNCTION |
| | | | 190-255 | RANDOM SROBE |
| CH.12 | CH.15 | CH.18 | CONTROL | |
| | | | 000-010 | NO FUNCTION |
| | | | 011-020 | PAN/TILT BLACK ACTIVATED |
| | | | 021-030 | PAN/TILT BLACK DEACTIVATED |
| | | | 031-040 | PAN INVERT |
| | | | 041-050 | TILT INVERT |
| | | | 051-060 | PAN/TILT INVERT OFF |
| | | | 061-070 | FAN SLOW |
| | | | 071-080 | FAN NORMAL |
| | | | 081-090 | FAN FAST |
| | | | 091-100 | FAN AUTO |
| | | | 101-110 | DIM4 |
| | | | 111-120 | DIM3 |
| | | | 121-130 | DIM2 |
| | | | 131-140 | DIM1 |
| | | | 141-150 | DIM0 |
| | | | 151-160 | 1200Hz |
| | | | 161-170 | 2400Hz |
| | | | 171-180 | 4000Hz |
| | | | 181-190 | 6000Hz |
| | | | 191-200 | 25000Hz |
| | | | 201-210 | ALL RESET |
| 211-220 | XY RESET | | | |

1.2 Safety warning

IMPORTANT

Always read the user manual before operation.
Please confirm that the power supply stated on the product is the same as the mains power supply in your area.

- This product must be installed by a qualified professional.
- Always operate the equipment as described in the user manual.
- A minimum distance of 0.5m must be maintained between the equipment and combustible surface.
- The product must always be placed in a well ventilated area.
- Always make sure that the equipment is installed securely.
- Do not stand close to the equipment and stare directly into the LED light source.
- Always disconnect the power supply before attempting and maintenance.
- Always make sure that the supporting structure is solid and can support the combined weight of the products.
- The earth wire must always be connected to the ground.
- Do not touch the power cables if your hands are wet.

ATTENTION



- This product left the place of manufacture in perfect condition. In order to maintain this condition and for safe operation, the user must always follow the instructions and safety warnings described in this user manual.
- Avoid shaking or strong impacts to any part of the equipment.
- Make sure that all parts of the equipment are kept clean and free of dust.
- Always make sure that the power connections are connected correct and secure.
- If there is any malfunction of the equipment, contact your distributor immediately.
- When transferring the product, it is advisable to use the original packaging in which the product left the factory.
- Shields, lenses or ultraviolet screens shall be changed if they have become damaged to such an extent that their effectiveness is impaired.
- The lamp (LED) shall be changed if it has become damaged or thermally deformed.



Caution, risk of electric shock
The light source contained in this luminaire shall only be replaced by the manufacturer or his service agent or a similar qualified person.

2 Installation

2.1 Mounting

The fixture can be mounted in any position.
Always ensure that mounting surface can withstand 10 times the weight of the fixture.

Always use a safety cable when mounting the fixture in any elevated position.

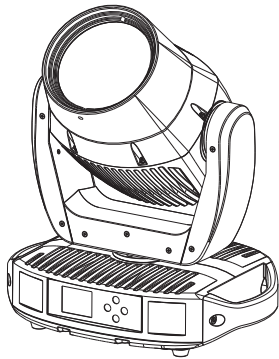

UPRIGHT

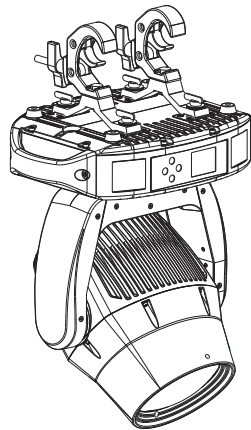

HANGING

2.2 Fuse replacement

- Remove the safety cap by a screwdriver.
- Fetch the old fuse from safety cap.
- Install a new fuse.
- Install the safety cap.

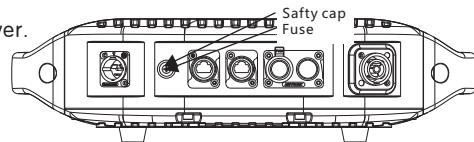

| BASIC (12CH) | STANDARD (15CH) | EXTEND (18CH) | VALUE | FUNCTION |
|--------------|---|---------------|----------------------|---|
| CH.5 | CH.7 | CH.8 | 053-058 | ROTATING GOBO 8 |
| | | | 059-066 | ROTATING GOBO 1 SHAKE (SPEED 1 → 100%) |
| | | | 067-074 | ROTATING GOBO 2 SHAKE (SPEED 1 → 100%) |
| | | | 075-082 | ROTATING GOBO 3 SHAKE (SPEED 1 → 100%) |
| | | | 083-090 | ROTATING GOBO 4 SHAKE (SPEED 1 → 100%) |
| | | | 091-098 | ROTATING GOBO 5 SHAKE (SPEED 1 → 100%) |
| | | | 099-106 | ROTATING GOBO 6 SHAKE (SPEED 1 → 100%) |
| | | | 107-114 | ROTATING GOBO 7 SHAKE (SPEED 1 → 100%) |
| | | | 115-122 | ROTATING GOBO 8 SHAKE (SPEED 1 → 100%) |
| | | | 123-127 | WHITE |
| | | | 128-190 | ROTATING GOBO FLOWING WATER EFFECT (SPEED 100 → 1%) |
| | | | 191-192 | STOP WATER EFFECT |
| 193-255 | ROTATING GOBO FLOWING WATER EFFECT (SPEED 1 → 100%) | | | |
| CH.6 | CH.8 | CH.9 | GOBO ROTATING | |
| | | | 0-120 | ROTATING GOBO ANGLE ADJUSTMENT (0 → 360°) |
| | | | 121-125 | STOP |
| | | | 126-165 | ROTATING GOBO SHAKE (SPEED 1 → 100%) |
| | | | 166-170 | STOP |
| | | | 171-210 | ROTATING GOBO POSITIVE ROTATION (SPEED 100% → 1) |
| | | | 211-215 | STOP |
| | | | 216-255 | ROTATING GOBO REVERSE ROTATION (SPEED 1 → 100%) |
| - | - | CH.10 | 000-255 | GOBO ROTATING FINE |
| CH.7 | CH.9 | CH.11 | PRISM 1 | |
| | | | 0-10 | WHITE |
| | | | 11-145 | PRISM INSERT AND ADJUST THE ANGLE (0 → 360°) |
| | | | 146-150 | STOP |
| | | | 151-200 | PRISM INSERT AND POSITIVE ROTATION (SPEED 100% → 1) |
| | | | 201-205 | STOP ROTATION |
| | | | 206-255 | PRISM INSERT AND REVERSE ROTATION (SPEED 1 → 100%) |
| CH.8 | CH.10 | CH.12 | PRISM 2 | |
| | | | 0-10 | WHITE |
| | | | 11-145 | PRISM INSERT AND ADJUST THE ANGLE (0 → 360°) |
| | | | 146-150 | STOP |
| | | | 151-200 | PRISM INSERT AND POSITIVE ROTATION (SPEED 100% → 1) |
| 201-205 | STOP ROTATION | | | |

4 Using a DMX512 Controller

4.1 Channel Assignment

Note: this product have DMX512 channel configuration: [BASIC] , [STANDARD] , [EXTEND] .

| BASIC (12CH) | STANDARD (15CH) | EXTEND (18CH) | VALUE | FUNCTION |
|--------------|---|---------------|-------------------|---|
| CH.1 | CH.1 | CH.1 | 000-255 | PAN 0-540° |
| - | CH.2 | CH.2 | 000-255 | PAN FINE |
| CH.2 | CH.3 | CH.3 | 000-255 | TILT 0-270° |
| - | CH.4 | CH.4 | 000-255 | TILT FINE |
| CH.3 | CH.5 | CH.5 | 000-255 | PT Speed |
| CH.4 | CH.6 | CH.6 | COLOR WHELL1 9+1 | |
| | | | 000-007 | WHITE |
| | | | 008-013 | COLOR 1 |
| | | | 014-019 | COLOR 2 |
| | | | 020-025 | COLOR 3 |
| | | | 026-031 | COLOR 4 |
| | | | 032-037 | COLOR 5 |
| | | | 038-043 | COLOR 6 |
| | | | 044-049 | COLOR 7 |
| | | | 050-055 | COLOR 8 |
| | | | 056-063 | COLOR 9 |
| | | | 064-191 | COLOR WHELL1 0-360° |
| | | | 192-222 | COLOR WHELL1 RAINBOW EFFECT(SPEED 100%→1) |
| | | | 223-224 | STOP |
| 225-255 | COLOR WHELL1 RAINBOW EFFECT(SPEED 1→100%) | | | |
| - | - | CH.7 | 000-255 | COLOR WHELL FINE |
| | | | ROTATING GOBO 8+1 | |
| | | | 000-010 | ROTATING WHITE |
| | | | 011-016 | ROTATING GOBO 1 |
| | | | 017-022 | ROTATING GOBO 2 |
| | | | 023-028 | ROTATING GOBO 3 |
| | | | 029-034 | ROTATING GOBO 4 |
| | | | 035-040 | ROTATING GOBO 5 |
| | | | 041-046 | ROTATING GOBO 6 |
| | | | 047-052 | ROTATING GOBO 7 |

2.3 Power connections

This product uses input and output power cable is 1.5 square mm copper wire
Note:

If the signal cable is over 60m between the DMX512 controller and fixture or between two fixtures, then a DMX signal amplifier is needed as well.

3 Display panel operation

3.1 Display operation

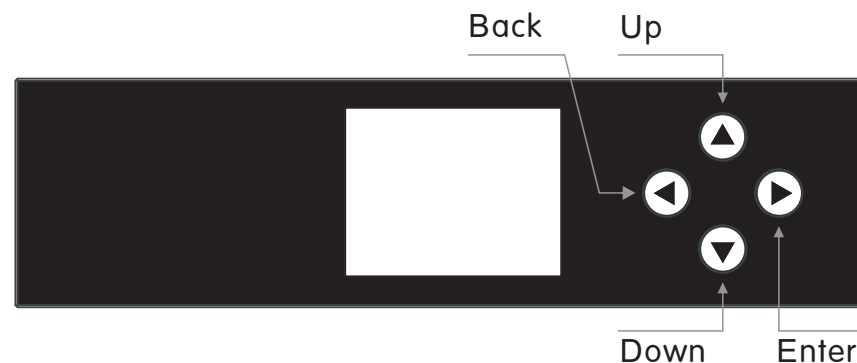

- Up: Scroll 'UP' through the menu list or increase the value of the current function.
- Down: Scroll 'DOWN' through the menu list or decrease the value of the current function.
- Left(Back): Scroll through the main menu or exit from the current sub-menu (press and hold to turn off power). When the display screen is off, you can long press 3-5 seconds to start the display screen, Enter the password "up down up down" to enter the display Settings.
- Right(Enter): Enter the currently selected menu or confirm the current function value.

3.2 Menu

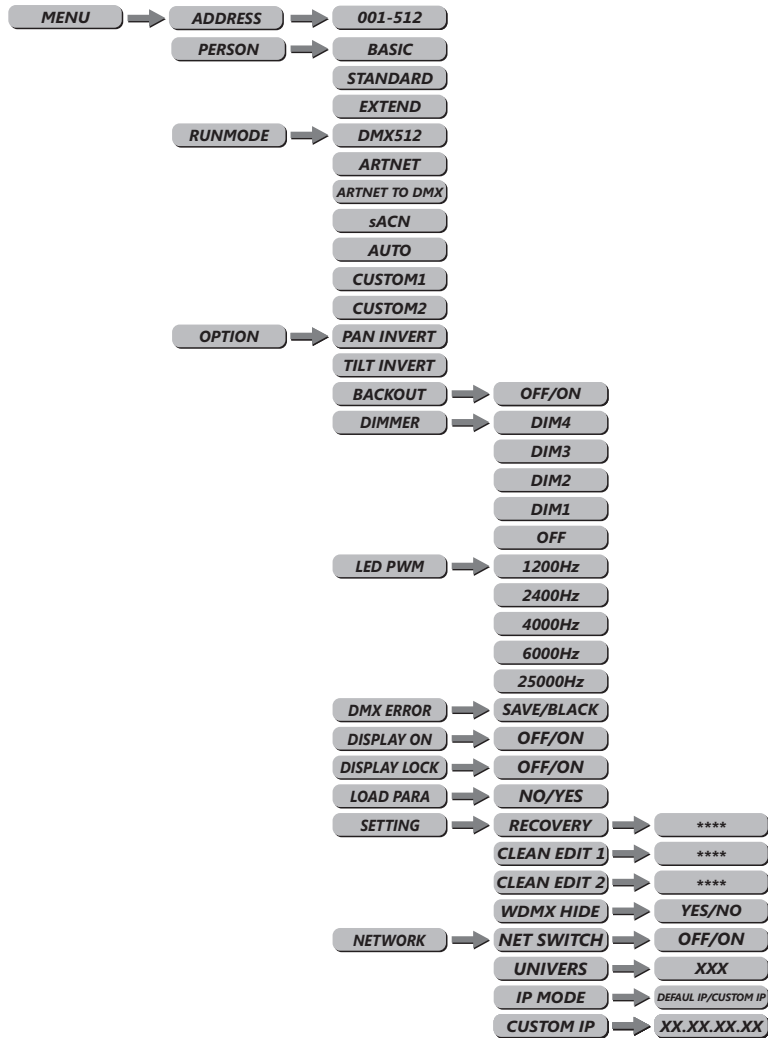

3.10 SERVICE

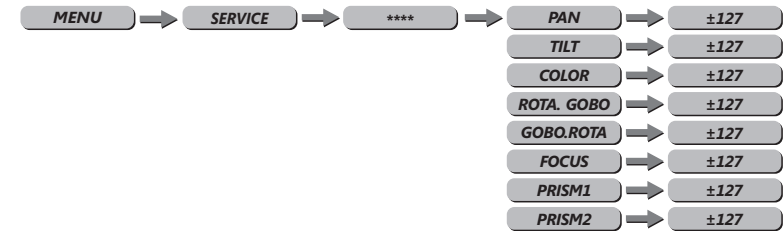

- Press [ENTER] into [SERVICE] Enter password to enter the options page.
 - [PAN] Pan position fine adjustment, Push up and down buttons adjust ± 127 value.
 - [TILT] Tilt position fine adjustment, Push up and down buttons adjust ± 127 value.
 - [COLOR] Color position fine adjustment, Push up and down buttons adjust ± 127 value.
 - [ROTA. GOBO] Rotation gobo position fine adjustment, Push up and down buttons adjust ± 127 value.
 - [GOBO.ROTA] Gobo self-rotation position fine adjustment, Push up and down buttons adjust ± 127 value.
 - [FOCUS] Focus position fine adjustment, Push up and down buttons adjust ± 127 value.
 - [PRISM 1] Prism position fine adjustment, Push up and down buttons adjust ± 127 value.
 - [PRISM 2] Prism position fine adjustment, Push up and down buttons adjust ± 127 value.

3.9 INFO

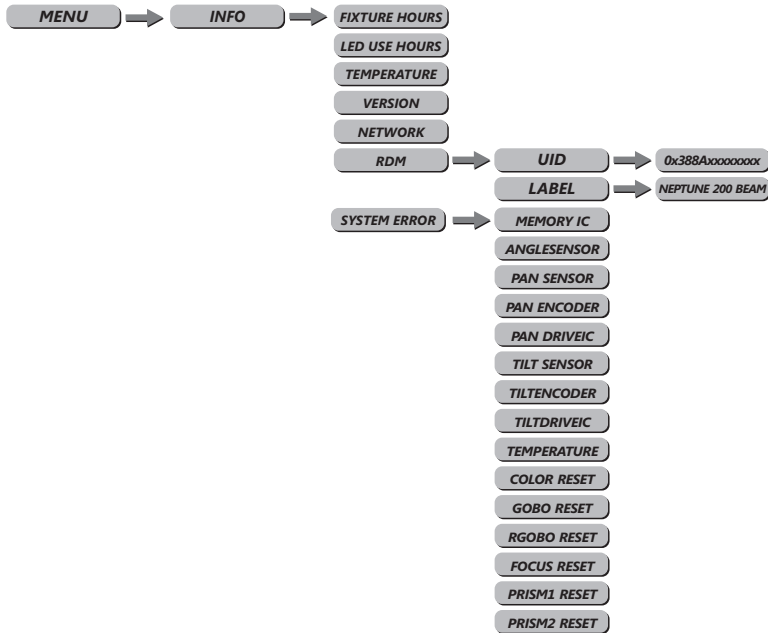

- Press [ENTER] into [INFO] check information,press up and down
 [FIXTURE HOURS] is hours of fixture use;
 [LED USE HOURS] is LED use time;
 [TEMPERATURE] is led temperature.
 [VERSION] is software versions;
 [NETWORK] check network parameter;
 [RDM] check fixture's ID.
 [SYSTEM ERROR] System information error: Memory IC,Angle Sensor,Pan Sensor,Pan Encoder,Pan Drive IC,Tilt Sensor,TiltEncoder,TiltDriveIC,Temperature,Color reset,Gobo reset,RGobo reset,Focus reset,Prism 1 reset,Prism 2 reset.

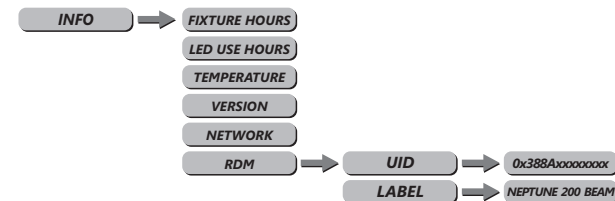
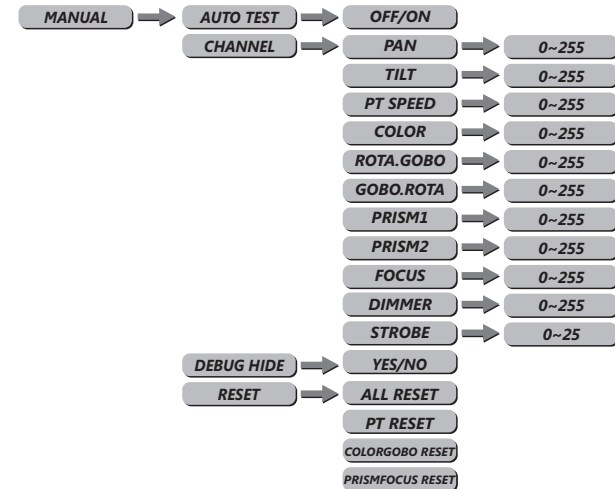
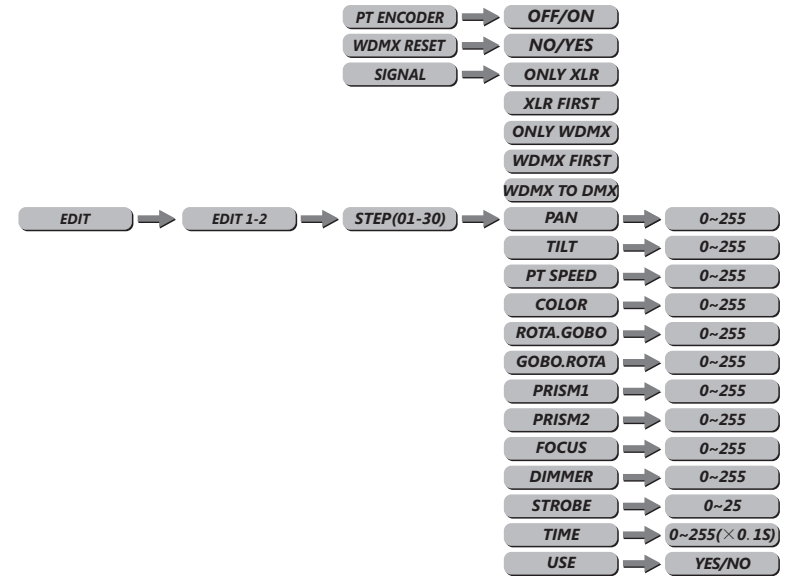

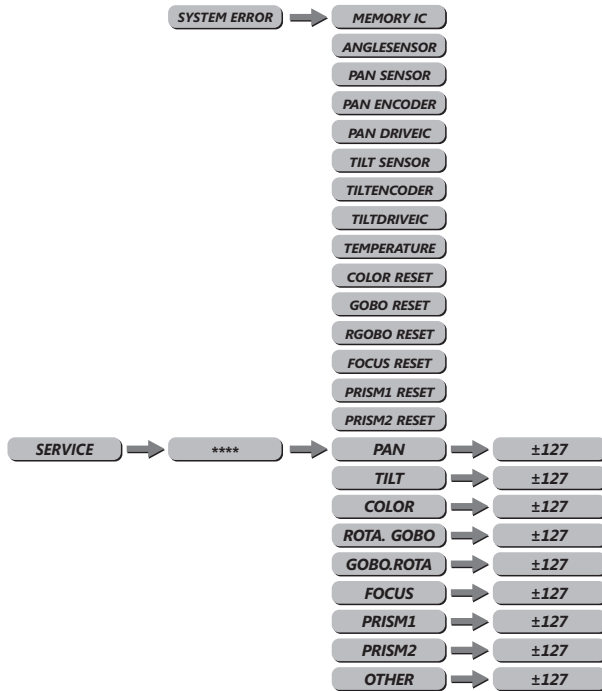

3.8 MANUAL

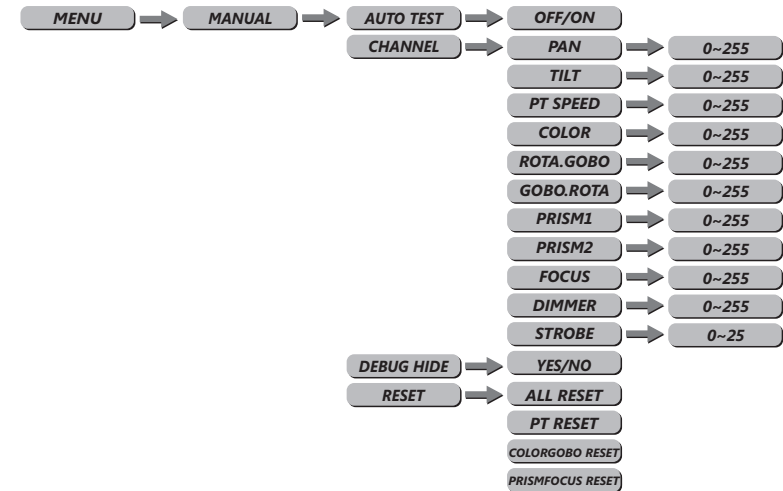

- Press [ENTER] into [AUTOTEST] at [MANUAL] .
- [PAN] pan set, [TILT] tilt set, [PTSPEED] set the pan & tilt speed, [COLOR] color temperature, [ROTA.GOBO] set the rotating gobo wheel, [GOBO.ROTA] set the autogiration of gobo wheell, [PRISM1] set the prism 1, [PRISM2] set the prism 2, [FOCUS] set the focusing, [DIMMER] set the dimmer, [STROBE] set the strobe, push the UP/DOWN to set the value [0~25] .
- [DEBUGHIDE] is the factory testing mode.All stepper motors are not controlled by signal,It only works again after the reset.enter No out、 enter Yes in.
- [RESET] set the reset:
 [ALL RESET] menu, select Yes/No to carry out all reset.
 [PT RESET] menu, select Yes/No to carry out PAN/TILT reset.
 [COLOR GOBO RESET] color wheel、 GOBO, press No do not resetting, press Yes resetting.
 [PRISM FOCUS RESET] focus、 prism, press No do not resetting, press Yes resetting.

3.7 EDIT



- Enter the [Edit] mode to edit the custom programs by adjusting the value of [PAN], [TILT], [PT SPEED], [COLOR], [ROTA.GOBO], [GOBO.ROTA], [PRISM 1], [PRISM 2], [FOCUS], [DIMMER], [STROBE], [TIME] .
- Enter [Use] and select [Yes] to run the steps user need.
- Note:if user want to circulate the created steps,please set the last step' s [TIME] as 0.

For example,there are 3 steps,the setting should be like belowed:

Step 1 [TIME] =4 [Use] =Yes
Step 2 [TIME] =5 [Use] =Yes
Step 3 [TIME] =0 [Use] =Yes

3.3 DMX Address



- Enter the [DMX] mode to set the DMX address.
- Enter Up/Down select [1~512] address.
- Enter [MENU] return.

3.4 Personality(Person)



- Enter the [PERSON] mode to select DMX mode: [STANDRAD], [BASIC], [EXTEND] .

3.5 Runmode

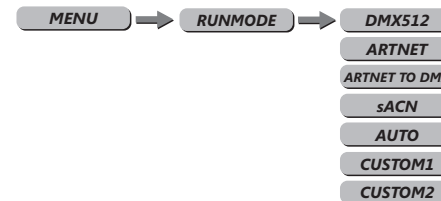

- [RUNMODE] menu, select required run mode, There are six modes inside: [DMX512] DMX512 Mode, [ARTNET] Artnet Mode, [ARTNET To DMX] ARTNET to DMX Mode, [sACN] sACN Mode, [AUTO] Auto run Mode, [CUSTOM1] Customer self-editing scene mode1, [CUSTOM2] Customer self-editing scene mode2 Press [DOWN] / [UP] select mode.
- Press [ENTER] accept, Press [MENU] return.

3.6 Performance(OPTION)

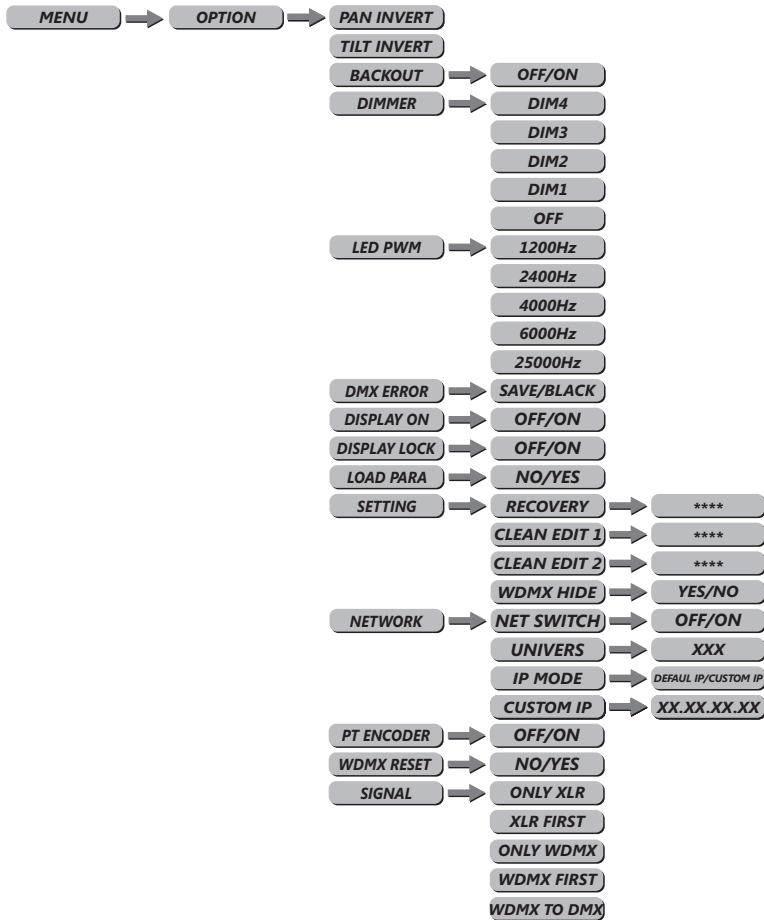

- Enter [OPTION] into the machine set.
- [PAN INVERT] menu, select [NORMAL] for normal direction,select [INVERT] for inverted of the PAN direction.
- [TILT INVERT] menu, select [NORMAL] for normal direction,select [INVERT] for inverted of the TILT direction.
- Choose [OFF] and [ON] to close and open the [BLACKOUT] mode.
- [DIMMER] menu for selection of [DIM1/DIM2/DIM3/DIM4/OFF] special dimming curves.

- [LED PWM] is PWM refresh rate bottom, press UP/DOWN to choose <1200Hz>、<2000Hz>、<2400Hz>、<6000Hz>、<25000Hz>;
Attention: The gray level of dimming will be reduced as the refresh rate increases.
- [DMX Error] menu, select [SAVE] to maintain last command in case of DMX error or [BLACK] for blackout.
- Choose [OFF] and [ON] to close and open the display open & close mode in menu [DISPLAY ON]
- Choose [OFF] and [ON] to close and open the screen lock mode in menu [DISPLAY LOCK]
- [LOAD PARA] is Parameter upload Settings, enter [NO] do not upload, enter [YES] upload.
- [SETTING] Maintain Settings, select [RECOVERY] is restore default factory Settings. Press [ENTER] Enter password then press [ENTER] ,if your password correct there will display [OK] .
[CLEAN EDIT1] clean Customer self-editing scene 1, press [ENTER] confirm.
[CLEAN EDIT2] clean Customer self-editing scene 2, press [ENTER] confirm.
[WDMX HIDE] hide wireless mode, WDMX RESET and SIGNAL hide and the default is wired mode only.
- [NETWORK] network setting, press [ENTER] in, Depending on the mode, you can hide unwanted features. For example Net Switch=Off IP Mode=Default.
[UNIVERS] Packet group Settings, output grouping 0~255.
[IP MODE] IP mode setting, [DEFAULTIP] is default IP, [CUSTOM IP] is customer's IP.
[CUSTOM IP EDIT] is customer's IP setting.
- [PT ENCODER] XY Encoder switch, [OFF] is close, [ON] is open.
- [WDMX RESET] wireless resetting,use for patch wireless signal, [YES] is Clear the receiver's message,press again patch wireless signal, [No] do not clear the receiver's message.
- [SIGNAL] is signal setting, ONLY XLR is wire only, XLR FIRST is wire first, ONLY WDMX is wireless only.WDMX FIRS is wireless first , WDMX TO DMX is wireless to wired.