

M-Vision Laser 18K Series

High Brightness Digital Video Projector

- ▶ INSTALLATION AND QUICK-START GUIDE
- ▶ CONNECTION GUIDE
- ▶ OPERATING GUIDE
- ▶ REFERENCE GUIDE



About This Document

Follow the instructions in this manual carefully to ensure safe and long-lasting use of the projector.

Symbols used in this manual

Many pages in this document have a dedicated area for notes. The information in that area is accompanied by the following symbols:



WARNING: this symbol indicates that there is a danger of physical injury to yourself and/or damage to the equipment unless the instructions are closely followed.



ELECTRICAL WARNING: this symbol indicates that there is a danger of electrical shock unless the instructions are closely followed.



LIGHT HAZARD WARNING: this symbol indicates that there is a danger of exposure to intensive light that may result in personal injury unless the instructions are closely followed.



LASER WARNING: this symbol indicates that there is a potential hazard of eye exposure to laser radiation unless the instructions are closely followed.



NOTE: this symbol indicates that there is some important information that you should read.

Product revision

Because we at Digital Projection continually strive to improve our products, we may change specifications and designs, and add new features without prior notice.

Updates may be available online - visit the Digital Projection website for all latest documents.

Legal notice

Trademarks and trade names mentioned in this document remain the property of their respective owners. Digital Projection disclaims any proprietary interest in trademarks and trade names other than its own.

Copyright © 2017 Digital Projection Ltd. All rights reserved.

Notes

Risk Group 3 Information

Light hazard warning



Failure to comply with the following may result in serious injury:

- No direct exposure to the beam is permitted, RG3 IEC 62471-5:2015.
- Operators control access to the beam within the hazard distance or install the projector at sufficient height to prevent exposures of spectators' eyes within the hazard distance.

The hazard distance (*Fig. 1*) is the distance measured from the projection lens at which the intensity or energy per unit of surface is lower than the applicable exposure limit on the cornea or skin. If the person is within the hazard distance, the beam is considered unsafe for exposure.

The hazard distance for this projector is 600 cm.

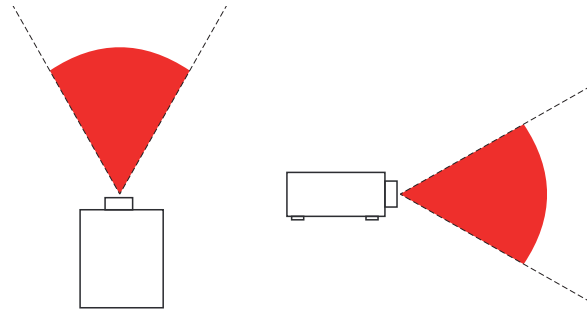
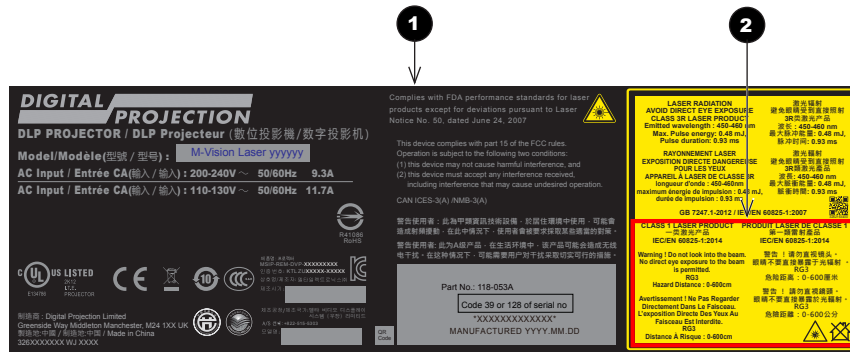

Fig. 1: hazard distance

Notes

Light hazard labels on the body of the projector

Light hazard labelling is part of the product label.



- 1** Product label
- 2** Risk Group 3 label
- 3** Hazard Warning symbol
- 4** Not For Home Use logo



Notes

Laser Information



Caution - use of controls or adjustments or performance of procedures other than those specified herein may result in hazardous radiation exposure.

Notes

Introduction

Congratulations on your purchase of this Digital Projection product.

Your projector has the following key features:

- WUXGA native resolution projector delivering 18,000 ISO lumens.
- Support for Frame Sequential and Dual Pipe 3D formats as well as Frame Packed, Side-by-Side etc. formats.
- HDBaseT® for transmission of uncompressed High Definition Video up to 100 m from the source.
- 3G-SDI with loop-through.
- Blanking control for custom input window sizing.
- Edge Blending with black level correction.
- Cornerstone, Vertical & Horizontal Keystone, Pincushion & Barrel, and Image Rotation.
- Non-Linear warp for irregular projection surfaces.
- Separate control of screen and source aspect ratio.
- Constant brightness mode maintains light output at selected levels.
- Control via LAN and RS232.
- Motorised lens mount.

A serial number is located on the side of the projector. Record it here:

Notes

CONTENTS

INSTALLATION AND QUICK-START GUIDE	1	CONNECTION GUIDE	23
WHAT'S IN THE BOX?	3	SIGNAL INPUTS AND OUTPUTS	25
CONNECTING THE POWER SUPPLY	4	Digital inputs and outputs.....	25
PROJECTOR OVERVIEW	5	EDID on the DisplayPort, HDMI and HDBaseT inputs.....	26
Front and rear views	5	Using DisplayPort/HDMI/HDBaseT switchers with the projector	26
Control panel.....	6	3D connections	27
<i>Projector indicators</i>	7	<i>Frame sequential 1080p and WUXGA 3D sources at 100 and 120 Hz</i>	27
REMOTE CONTROL	8	<i>Dual Pipe 1080p, WUXGA and WQXGA 3D sources at 100 and 120 Hz</i>	27
Infrared reception.....	11	3D Sync.....	28
POSITIONING THE SCREEN AND PROJECTOR	12	3D Sync In	28
Roll and pitch	13	3D Sync Out.....	28
Stacking instructions	14	CONTROL CONNECTIONS	29
CHANGING THE LENS	17	LAN connection examples	30
Inserting a new lens	17	RS232 connection example	31
Removing the lens	18		
OPERATING THE PROJECTOR	19		
Switching the projector on.....	19		
Switching the projector off.....	19		
Selecting an input signal	20		
Selecting a test pattern	20		
Adjusting the lens.....	21		
Adjusting the image.....	21		

CONTENTS (continued)

OPERATING GUIDE	33		
USING THE MENUS	35		
Opening the OSD.....	35		
Opening a menu.....	35		
Exiting menus and closing the OSD.....	35		
Inside a menu.....	36		
<i>Accessing sub-menus.....</i>	36		
<i>Executing commands.....</i>	36		
Editing projector settings.....	37		
<i>Using a slider to set a value.....</i>	37		
<i>Editing numeric values</i>	37		
USING THE PROJECTOR.....	38		
Main menu	38		
Lens menu	39		
<i>Lens Control.....</i>	39		
<i>Lens Memory.....</i>	40		
Image menu	41		
Color menu.....	42		
<i>Color Space</i>	42		
<i>Color Mode</i>	43		
Geometry menu	48		
<i>Aspect Ratio.....</i>	48		
<i>Digital Zoom.....</i>	50		
<i>Overscan.....</i>	51		
<i>Blanking.....</i>	52		
<i>Keystone</i>	53		
<i>4 Corners</i>	55		
		<i>Rotation</i>	56
		<i>Pincushion / Barrel.....</i>	57
		<i>Arc.....</i>	58
		<i>Custom Warp</i>	58
		Edge Blend menu.....	59
		<i>Blend Width.....</i>	60
		<i>Black Level Uplift.....</i>	61
		3D menu.....	62
		<i>3D types.....</i>	63
		<i>Some 3D settings explained</i>	64
		Laser menu	65
		Setup menu.....	66
		<i>ColorMax Setting</i>	68
		<i>Power On/Off.....</i>	69
		<i>Clock Adjust</i>	70
		<i>OSD Settings.....</i>	71
		<i>Memory.....</i>	71
		Network menu	72
		PIP menu	73
		Information menu	74
		<i>Signal Format</i>	74
		<i>System Status</i>	75
		<i>Thermal Status.....</i>	75
		<i>Factory Reset</i>	76

CONTENTS (continued)

REFERENCE GUIDE.....77

THE DMD™ 79

CHOOSING A LENS 81

 Basic calculation 82

 Basic calculation example..... 83

 Full lens calculation..... 84

Introducing TRC 84

Calculating TRC 85

Calculating the throw ratio with TRC 86

 Full lens calculation example 87

POSITIONING THE SCREEN AND PROJECTOR..... 88

POSITIONING THE IMAGE 89

FRAME RATES AND PULLDOWNS EXPLAINED..... 91

 Interlaced and progressive scan 91

 Frame rates of image sources 91

 Pulldowns - conversion into destination formats..... 92

2:3 (normal) pulldown 92

2:3:3:2 (advanced) pulldown..... 93

APPENDIX A: LENS PART NUMBERS..... 94

APPENDIX B: SUPPORTED SIGNAL INPUT MODES 95

 2D formats..... 95

 3D formats..... 98

APPENDIX C: WIRING DETAILS 100

 RS232 100

 Trigger 1 & Trigger 2 101

 Wired remote control..... 101

 Sync IN and Sync OUT 101

APPENDIX D: GLOSSARY OF TERMS 102

This page is intentionally left blank.



M-Vision Laser 18K Series

High Brightness Digital Video Projector

▶ INSTALLATION AND QUICK-START GUIDE



IN THIS GUIDE

- WHAT'S IN THE BOX?3**
- CONNECTING THE POWER SUPPLY4**
- PROJECTOR OVERVIEW.....5**
 - Front and rear views5
 - Control panel6
 - Projector indicators7
- REMOTE CONTROL.....8**
 - Infrared reception.....11
- POSITIONING THE SCREEN AND PROJECTOR12**
 - Roll and pitch13
 - Stacking instructions.....14
- CHANGING THE LENS17**
 - Inserting a new lens17
 - Removing the lens18
- OPERATING THE PROJECTOR19**
 - Switching the projector on.....19
 - Switching the projector off.....19
 - Selecting an input signal.....20
 - Selecting a test pattern.....20
 - Adjusting the lens21
 - Adjusting the image.....21

What's In The Box?

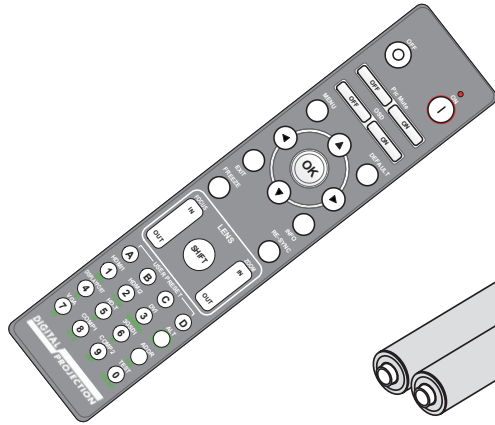

Remote control

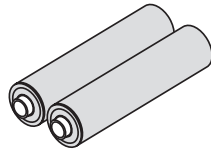

2x AAA batteries

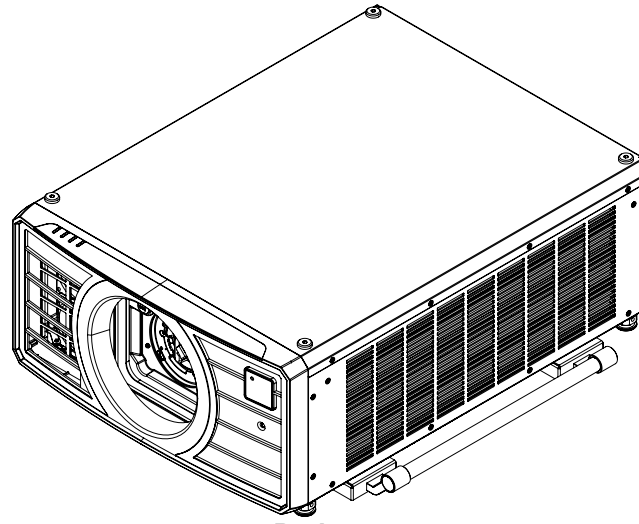

Projector

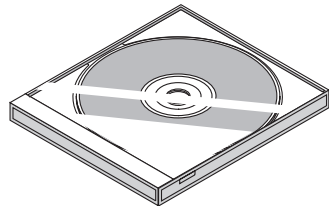

User Manual on disc

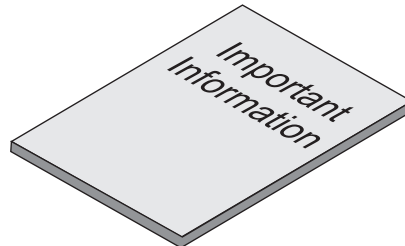

Important Information

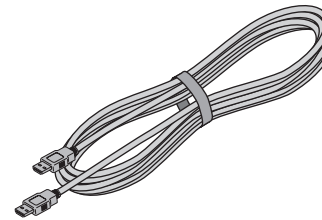

HDMI cable

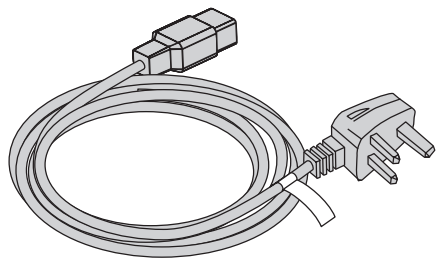

Power cable, United Kingdom

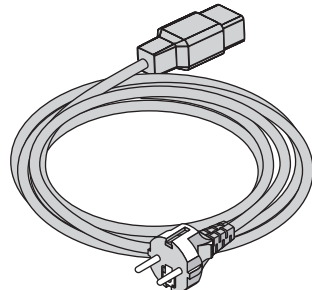

Power cable, Europe

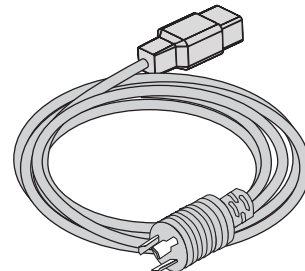

Power cable, North America

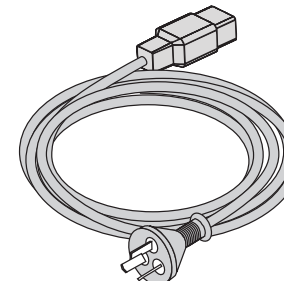

Power cable, China

Notes



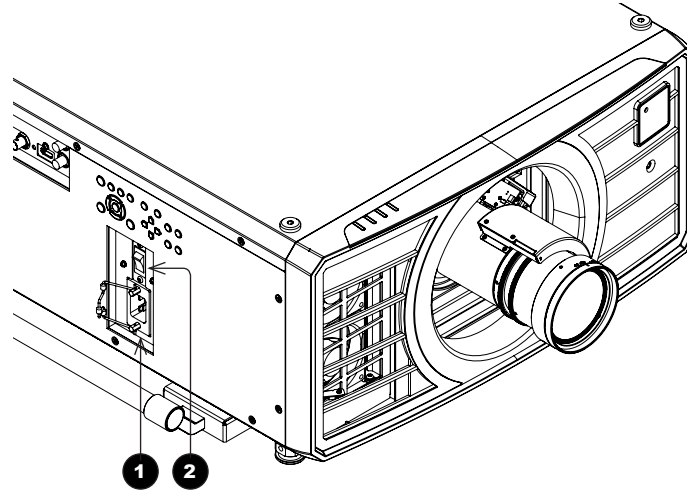

- Make sure your box contains everything listed. If any pieces are missing, contact your dealer.
- You should save the original box and packing materials, in case you ever need to ship your projector.
- The projector is shipped without a lens.
- Only one power cable - dependent on the destination territory - will be supplied with the projector.
- A stacking kit is also provided in some regions.

Connecting The Power Supply

Firmly push the mains connector into the **socket 1**, then press the **ON/OFF switch 2**.



Notes

-  Use only the power cable provided.
-  Ensure that the power outlet includes a ground connection as this equipment **MUST** be earthed.
-  Handle the power cable carefully and avoid sharp bends. Do not use a damaged power cable.
-  When operating on 110V Light output power is reduced by approx 35%.

Projector Overview

Front and rear views

- 1 Indicators: TEMP, LIGHT, STATUS and POWER
- 2 Lens mount
- 3 Air inlet
- 4 Lifting handle
- 5 Air inlet
- 6 Front infrared window
- 7 Stacking feet
- 8 Air outlet
- 9 Rear infrared window
- 10 Connections panel
- 11 Lifting handle
- 12 Control panel
- 13 Adjustable feet
- 14 Stacking feet
- 15 Mains socket and switch

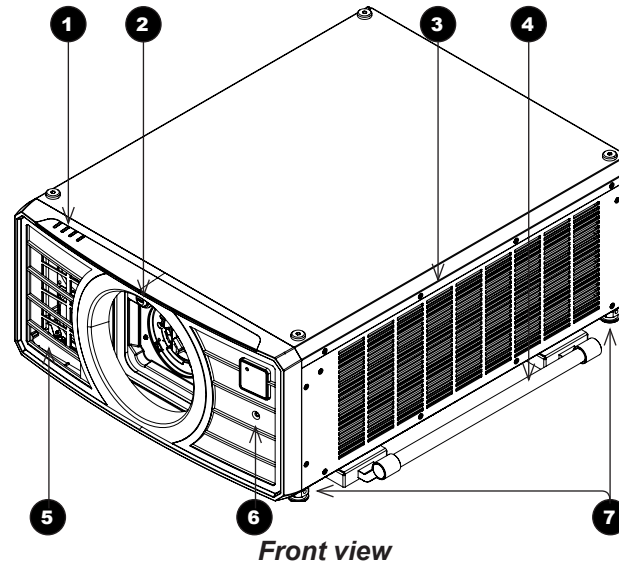

Front view

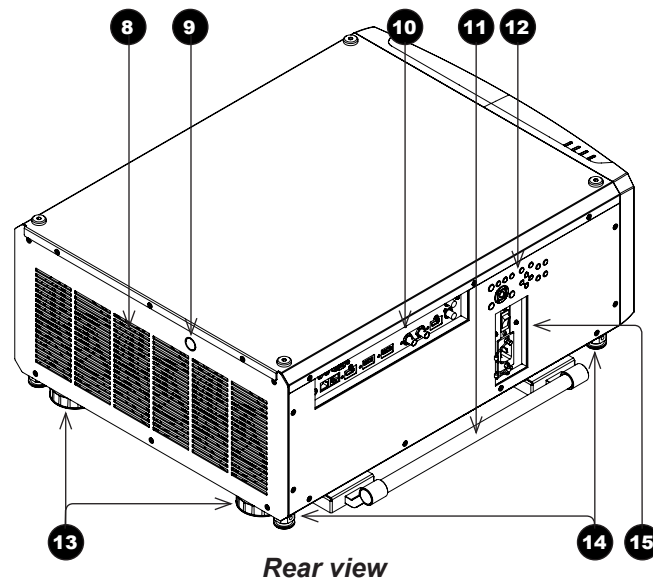

Rear view

Notes

Control panel

- 1 POWER**
Switches the projector on and off (STANDBY).
- 2 INPUT**
Switches to the next input source.
- 3 AUTO SYNC**
Re-synchronises with the current input signal.
- 4 ASPECT**
Changes the aspect ratio.
- 5 CENTER LENS**
Centers the lens.
- 6 PIC MUTE**
Shows and hides the projected image. When OFF, the light source is completely switched off and the screen is black.
- 7 MENU**
Displays and exits the OSD.
- 8 Arrow buttons & ENTER**
Navigation buttons used to highlight menu entries in the OSD. Press **ENTER** to open or execute the highlighted menu entry.
- 9 EXIT**
Exits the current OSD page and enters the level above.
- 10 LENS SHIFT arrow buttons**
Each of these buttons moves the lens in the specified direction.
- 11 FOCUS plus and minus buttons**
Used to move the focus in and out.
- 12 ZOOM plus and minus buttons**
Used to zoom in and out.

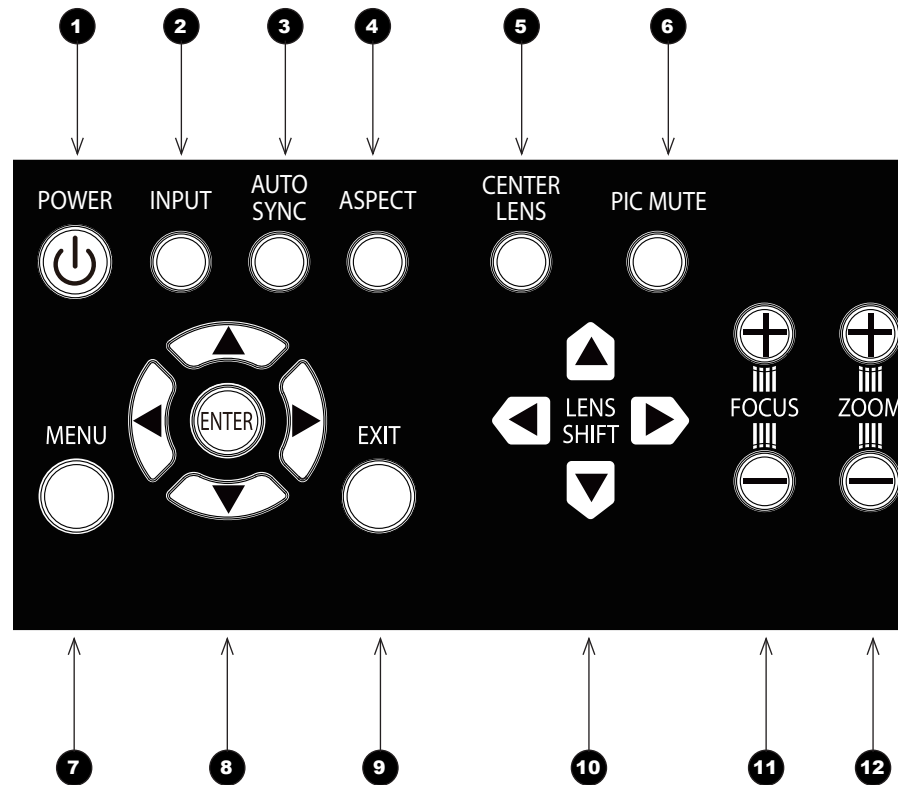

Notes

 *AUTO SYNC and ASPECT do not work when the projector uses HDMI 3 or 4.*

Projector indicators

TEMP. Off = no problem

Flashing red = temperature error

LIGHT Off = light is switched off

Flashing green = light is preparing to switch on

Flashing red (cycles of six flashes) = light module failure

On, green = light is switched on

STATUS Off = no problem

Flashing red (continuously) = cover error

Flashing red (cycles of four flashes) = fan error

On, red = system error

POWER Off = the projector is switched off

Flashing green = the projector is warming up

Flashing amber = the projector is cooling down

On, red = STANDBY mode

On, green = the projector is switched on

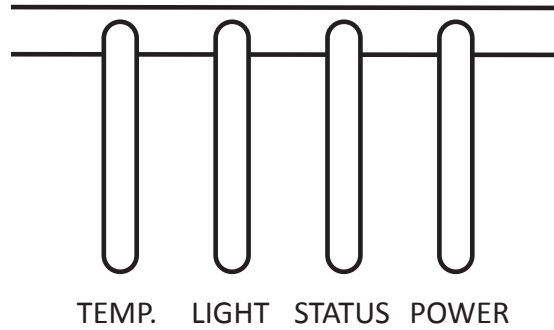

Notes

Remote Control

- 1 Power ON / OFF**
Turns power on and off.
- 2 Pic Mute OPEN / CLOSED**
Shows and hides the projected image.
When CLOSED, the light source is completely switched off and the screen is black.
- 2 OSD ON / OFF**
Enable and disable screen timeout messages and control whether to show the OSD during projection.
- 4 MENU**
Access the OSD. If the OSD is open, press this button to go back to the previous menu.
- 5 Navigation (arrows and OK)**
Navigate through the menus with the arrows, confirm your choice with **OK**.
In lens adjustment modes, the arrows are used to move, zoom or focus the lens. See **11** below.
In lens adjustment modes, or when the OSD is not showing, the **OK** button switches between modes: **Shift Adjustment** and **Zoom / Focus Adjustment**.
- 6 EXIT**
Go up one level in the OSD. When the top level is reached, press to close the OSD.
- 7 FREEZE**
Freeze the current frame.
- 8 DEFAULT**
When editing a parameter, press this button to restore the default value.
- 9 INFO**
Access information about the projector.
- 10 RE-SYNC**
Re-synchronise with the current input signal.

continues on next page...

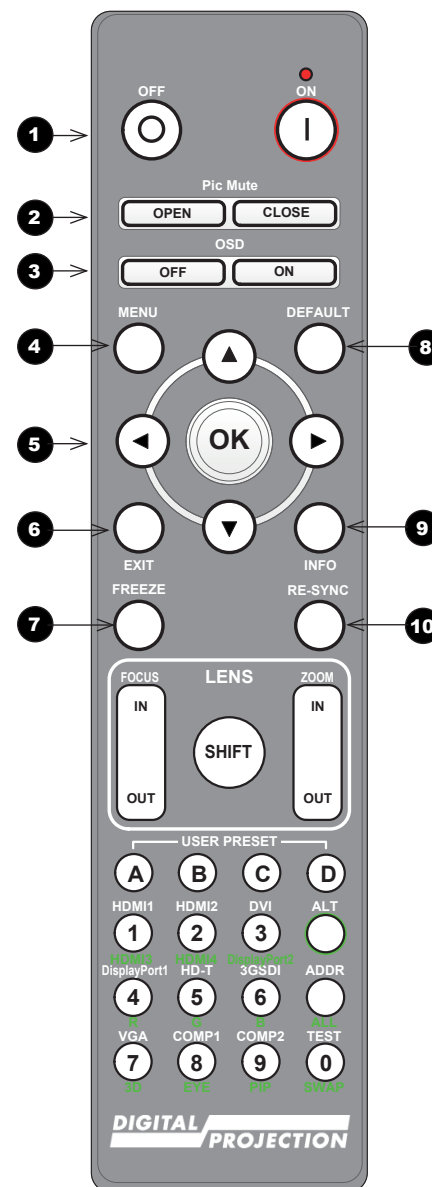

Remote control

Notes

 *FREEZE and RE-SYNC are not available when the projector uses input HDMI 3 or 4.*

 *This projector does not use the following options on the remote: DVI, VGA, COMP 1 and COMP 2.*

- 11** **LENS adjustment**
FOCUS IN / OUT: adjust focus.
SHIFT: press and hold this button, then use the Navigation arrow buttons to move the lens.
ZOOM IN / OUT: adjust zoom.
- 12** **USER PRESET A, B, C, D**
 Load user presets.
- 13** **ALT**
 Press and hold this button to access alternative functions for all buttons with a green label.
- 14** **DVI / DisplayPort2 / numeric input 3**
 There is no DVI input on this projector.
 Use with **ALT** to select the DisplayPort 2 input.
- 15** **HDMI 2 / HDMI 4 / numeric input 2**
 Select the HDMI 1 input.
 Use with **ALT** to select the HDMI 4 input.
- 16** **HDMI 1 / HDMI 3 / numeric input 1**
 Select the HDMI 1 input.
 Use with **ALT** to select the HDMI 3 input.
- 17** **TEST / SWAP / numeric input 0**
 Show a test pattern. Press again to show the next test pattern:
...Off, White, Black, Red, Green, Blue, CheckerBoard, CrossHatch, V Burst, H Burst, ColorBar...
 When **PIP** mode is on, use this button with **ALT** to swap the main and sub images.

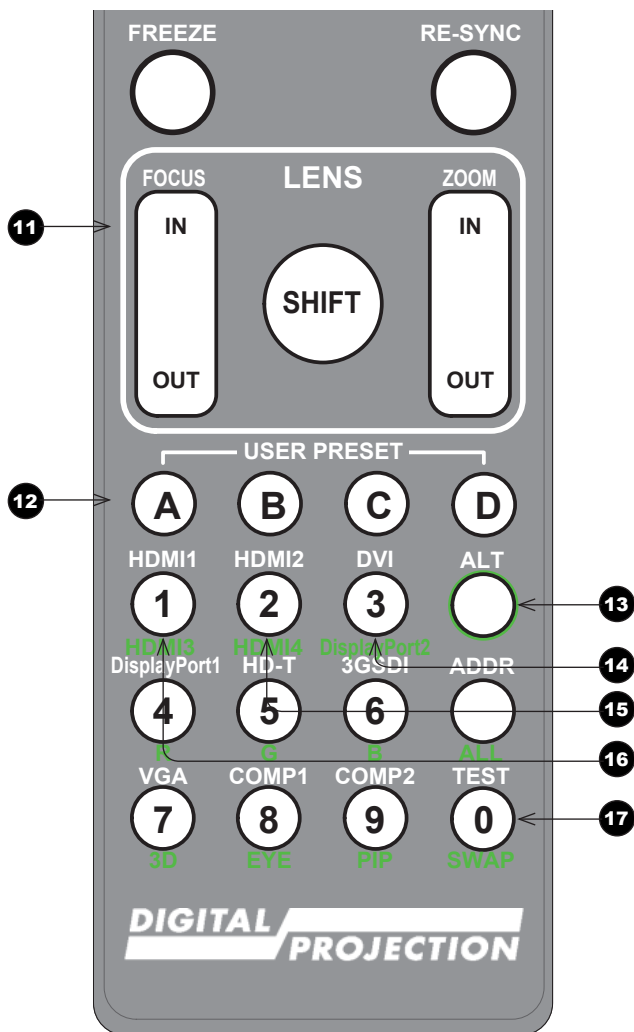

Remote control

Notes

 This projector does not use the following options on the remote:
 HDMI 3 and HDMI 4
 DVI, VGA, COMP 1 and COMP 2.

continues on next page...

- 17** **DISPLAYPORT 1 / R / numeric input 4**
Select DisplayPort 1 input.
- 18** **HD-T / G / numeric input 5**
Select the HDBaseT input.
- 19** **3GSDI / B / numeric input 6**
Select the 3G-SDI input.
- 20** **VGA / 3D / numeric input 7**
There is no VGA input on this projector.
Use with **ALT** to toggle the **3D Format** setting between **Off** and **Auto**.
- 21** **COMP1 / EYE / numeric input 8**
There is no Component 1 input on this projector.
Use with **ALT** to switch between left and right eye 3D dominance.
- 22** **COMP2 / PIP / numeric input 9**
There is no Component 2 input on this projector.
Use with **ALT** to switch on **Picture In Picture (PIP)** mode.
- 23** **ADDR / ALL (with red indicator at the top)**
Assign and unassign an IR remote address.
To assign an address:
 1. Press and hold this button until the indicator starts flashing.
 2. Release this button and while the indicator is still flashing, enter a two-digit address using the numeric input buttons. The indicator will flash three times quickly to confirm the change.**To unassign an address and return to the default address 00,**
 - Press and hold **ALT** and this button simultaneously until the indicator flashes to confirm the change.

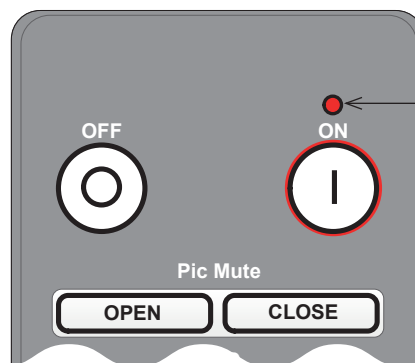

Remote control top

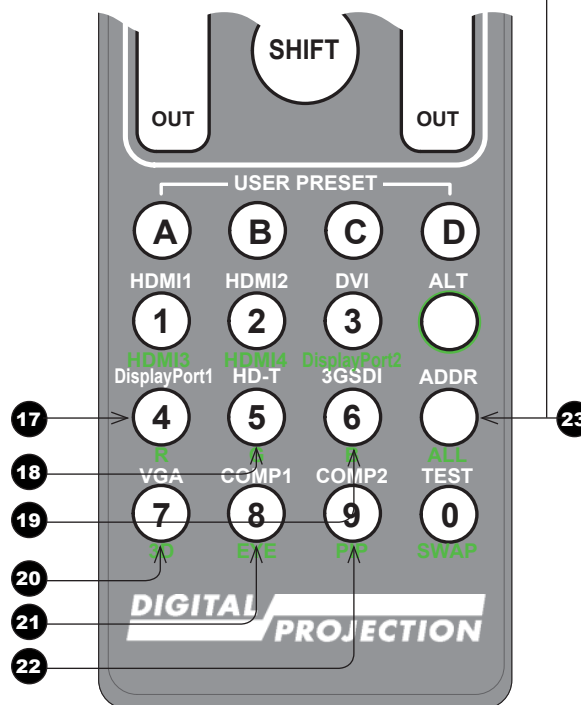

Remote control bottom

Notes

 This projector does not use the following options on the remote:
HDMI 3 and HDMI 4
DVI, VGA, COMP 1 and COMP 2.

Infrared reception

The projector has infrared sensors at the front and back.

The angle of acceptance is 40°. Make sure that the remote control is within the angle of acceptance when trying to control the projector.

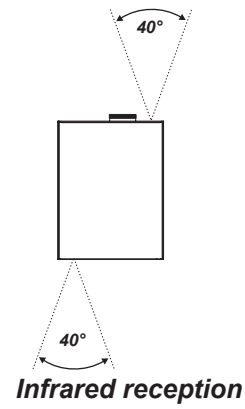

Notes

Positioning The Screen And Projector

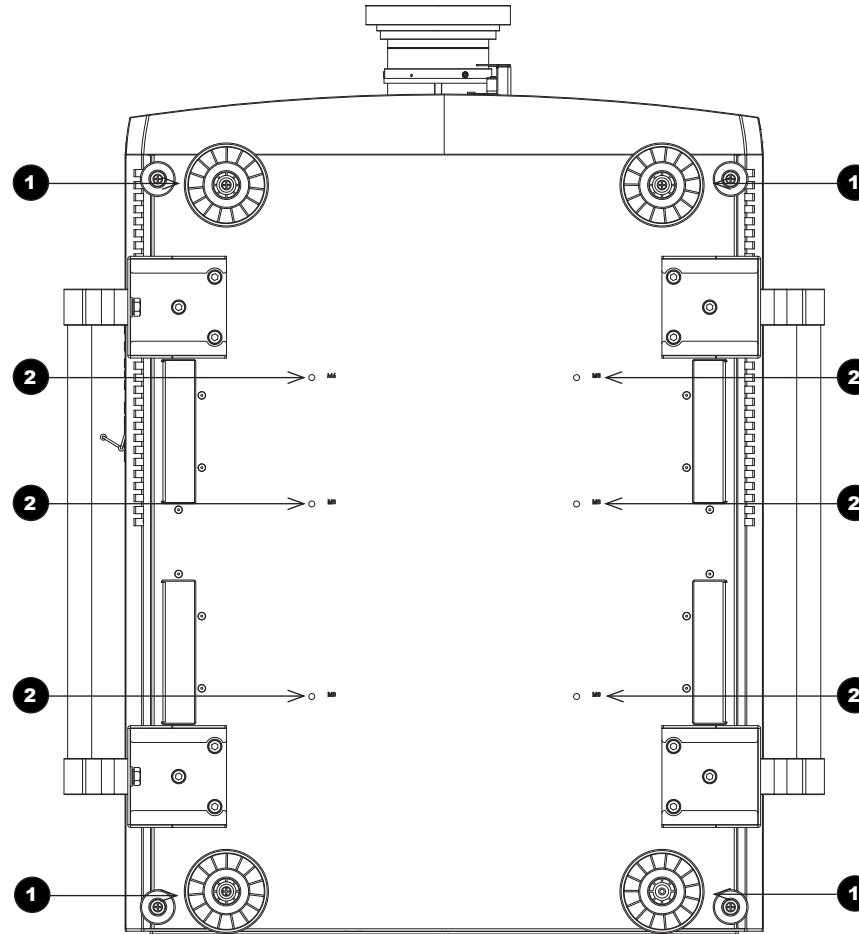

1. Install the screen, ensuring that it is in the best position for viewing by your audience.
2. Mount the projector, ensuring that it is at a suitable distance from the screen for the image to fill the screen. Set the adjustable feet so that the projector is level, and perpendicular to the screen.

The drawing below shows the positions of the feet for table mounting, and the fixing holes for ceiling mounting.



- 1** Four adjustable feet
- 2** Six M6 holes for ceiling mount
The screws should not penetrate more than 15 mm into the body of the projector.

Notes

-  **Always allow the projector to cool for 5 minutes before disconnecting the power or moving the projector.**
-  **Ensure that there is at least 50 cm (19.7 in) of space between the ventilation outlets and any wall, and 30 cm (11.8 in) on all other sides.**

Roll and pitch

The projector can be operated in any position, as shown in the illustration.

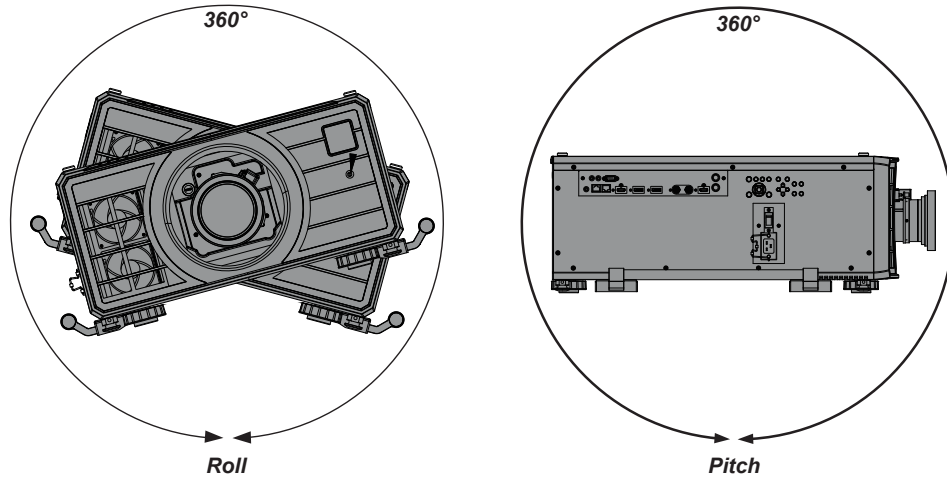

Fig. 1 Roll and pitch - any position is possible

However, the following positions are to be avoided as they can reduce motor life:

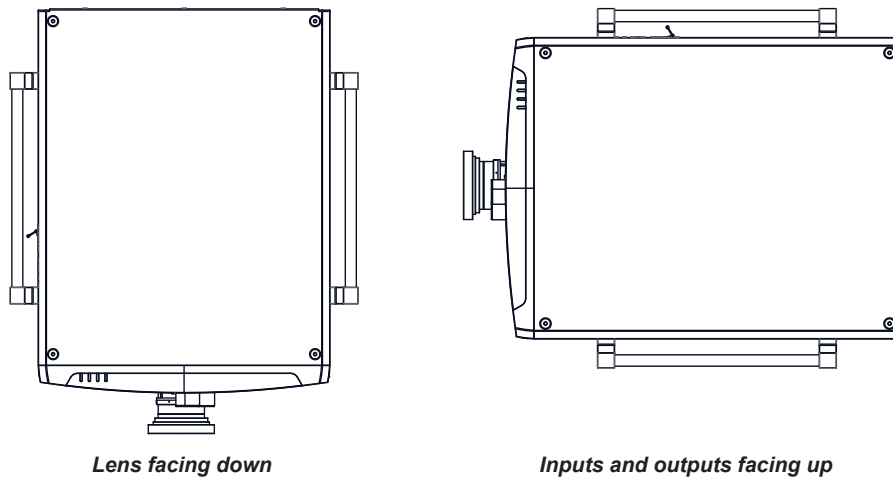
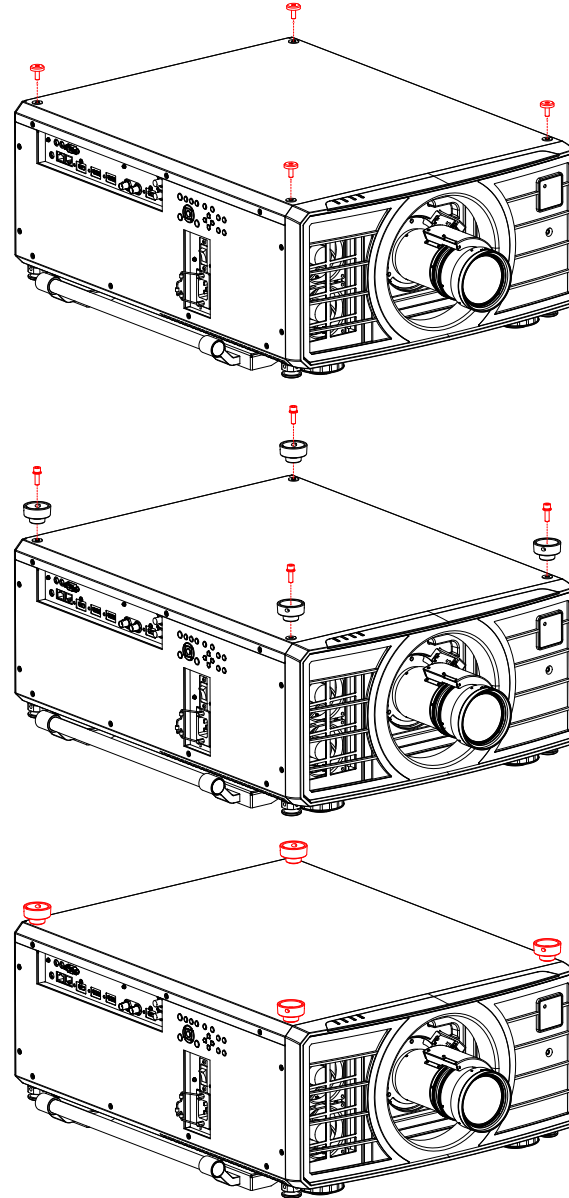

Fig. 2 Positions to avoid

Notes

Stacking instructions

1. On the bottom projector, remove the four screws on the top side. Insert and secure the stacking tops in their place.



Notes



When stacking projectors, the stack **MUST** be vertical, to ensure that the stresses are distributed to all four chassis corners.

Do not stack more than two projectors.

Do not use the provided eye bolts to suspend more than one projector. The eye bolts must not be used with stacks as they can carry the weight of one projector only.

Do not use the lifting handles when stacking. The handles will carry the weight of one projector only.

Use only the provided screws with a torque of 25-30 kgf cm (2.45 - 2.94 Nm).

It is the customer's responsibility to ensure that the assembly is carried out securely.



The stacking kit is provided in the box as standard in some regions. It is also available to order separately.

Stacking instructions continued

2. Remove the four adjustable feet of the top projector.
3. Slide the top projector over the bottom projector so the stacking feet are coupled with the stacking tops on the bottom projector.

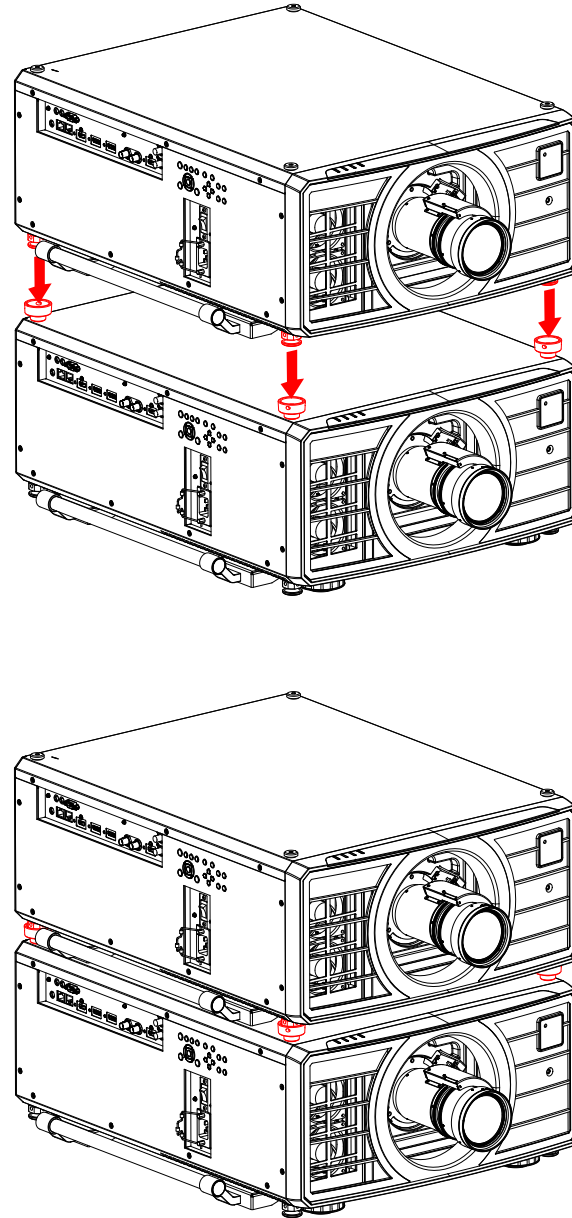
**Notes**

When stacking projectors, the stack **MUST** be vertical, to ensure that the stresses are distributed to all four chassis corners.

Do not stack more than two projectors.

Do not use the provided eye bolts to suspend more than one projector. The eye bolts must not be used with stacks as they can carry the weight of one projector only.

Do not use the lifting handles when stacking. The handles will carry the weight of one projector only.

Use only the provided screws with a torque of 25-30 kgf cm (2.45 - 2.94 Nm).

It is the customer's responsibility to ensure that the assembly is carried out securely.



The stacking kit is provided in the box as standard in some regions. It is also available to order separately.

Stacking instructions continued

4. Use the provided holding pins to secure each connection.

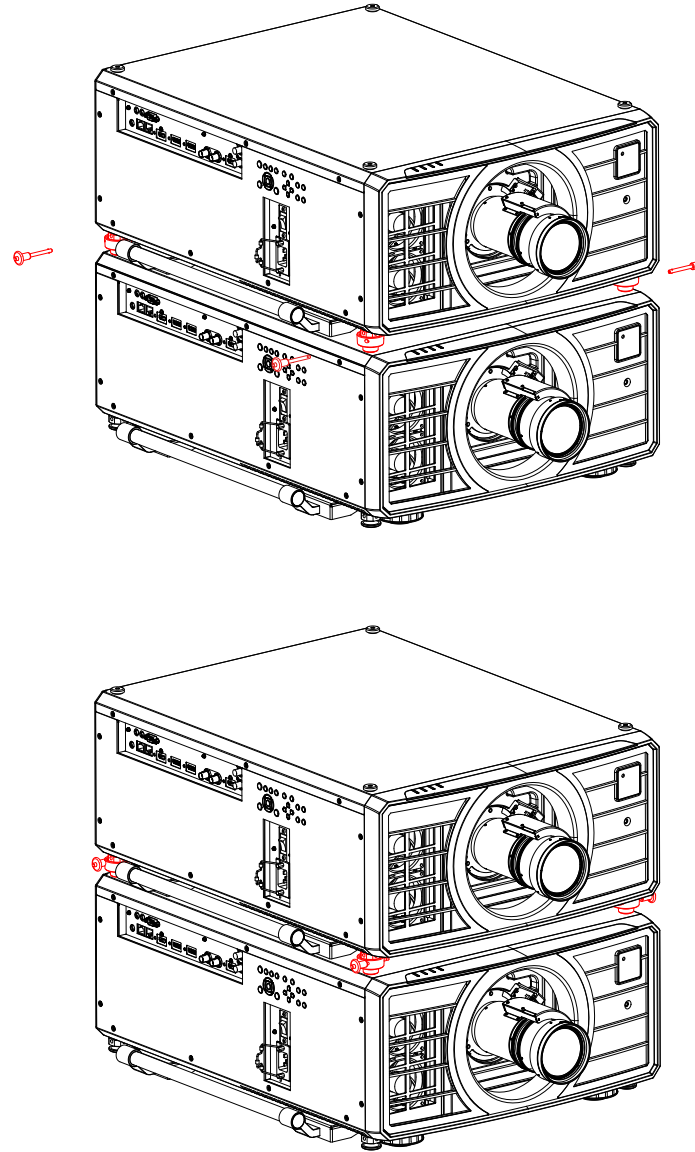
**Notes**

When stacking projectors, the stack **MUST** be vertical, to ensure that the stresses are distributed to all four chassis corners.

Do not stack more than two projectors.

Do not use the provided eye bolts to suspend more than one projector. The eye bolts must not be used with stacks as they can carry the weight of one projector only.

Do not use the lifting handles when stacking. The handles will carry the weight of one projector only.

Use only the provided screws with a torque of 25-30 kgf cm (2.45 - 2.94 Nm).

It is the customer's responsibility to ensure that the assembly is carried out securely.



The stacking kit is provided in the box as standard in some regions. It is also available to order separately.

Changing The Lens

Inserting a new lens

1. Remove the front and rear lens caps.
2. Insert the lens, keeping the connector in upright position.
3. Rotate the lens clockwise until it clicks into place.

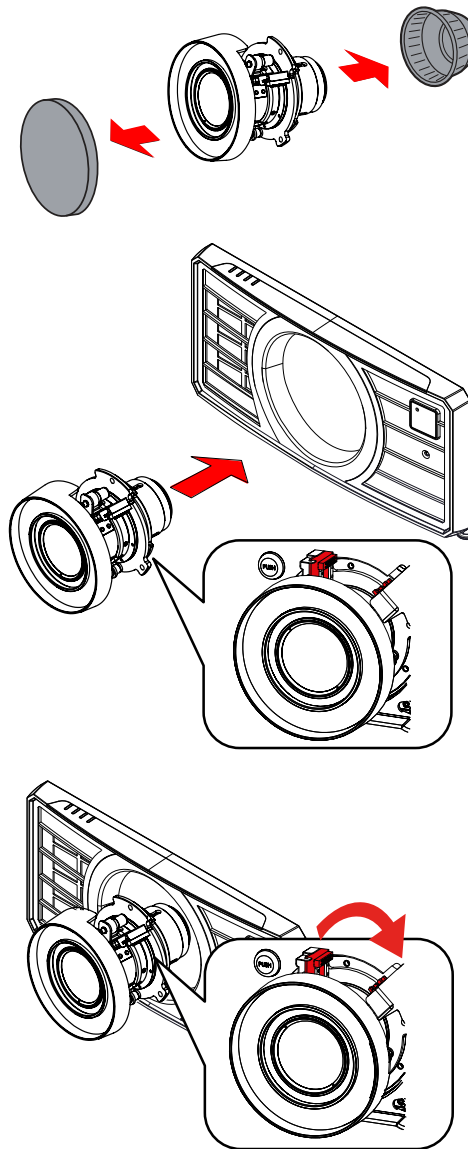

Notes



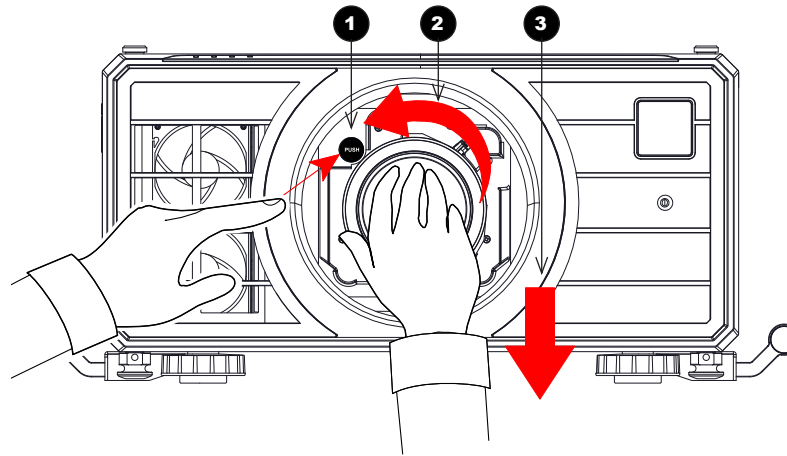

- ⚡ Before changing the lens, always make sure the projector is switched off and fully disconnected from its power supply.
- ⚠ When changing the lens, avoid using excessive force as this may damage the equipment.
- ✎ The lens is shipped separately.
- ✎ Take care to preserve the original lens packaging and protective caps for future use.
- ✎ The projector will not power on without the lens fitted.

Removing the lens

1. Push **the button 1** all the way in.
2. Rotate the lens **counterclockwise 2** until it disengages.
3. Slowly **pull the lens out 3**.



Notes

-  **Before changing the lens, always make sure the projector is switched off and fully disconnected from its power supply.**
-  **When changing the lens, avoid using excessive force as this may damage the equipment.**
-  *The lens is shipped separately.*
-  *Take care to preserve the original lens packaging and protective caps for future use.*
-  *The projector will not power on without the lens fitted.*

Operating The Projector

Switching the projector on

1. Ensure a lens is fitted. Connect the power cable between the mains supply and the projector. (See *Connecting the power supply* above.) Switch on at the switch next to the power connector.
2. The **POWER** indicator lights red to signal that the projector is in STANDBY mode. Press one of the following buttons:
 - On the remote control, the **ON** button
 - On the projector control panel, the **POWER** button.

The fans begin working, then the **POWER** indicator begins flashing green. When the flashing stops, the **POWER** and **LIGHT** indicators both light steady green. The projector is switched on.

Switching the projector off

1. Press **OFF** on the remote control or **POWER** on the control panel, then press again to confirm your choice.
The **POWER** indicator on the control panel will start flashing amber, the system will go out and the cooling fans will run for a short time until the **POWER** indicator goes steady red to indicate that the projector has entered STANDBY mode.
2. If you need to switch the projector off completely, switch off at the mains power switch next to the power connector and then disconnect the power cable from the projector.

Notes



See also [Connecting The Power Supply](#) earlier in this guide.



The self-test is running when all the LEDs on the control panel are lit.



Use only the power cable provided.



Ensure that the power outlet includes a ground connection as this equipment **MUST** be earthed.



Handle the power cable carefully and avoid sharp bends. Do not use a damaged power cable.

Selecting an input signal

1. Connect one or more image sources to the projector.
2. Select the input you want to display:
 - Press one of the input buttons on the remote control.
 - Alternatively, open the On-screen display (OSD) by pressing **MENU**. Highlight **Input** from the main menu, press **ENTER/OK** and then select an input signal using the **UP ▲** and **DOWN ▼** arrow buttons. Press **ENTER/OK** to confirm your choice.

Selecting a test pattern

To display a test pattern:

- Press **TEST** on the remote control.
Change the test pattern using the **LEFT ◀** and **RIGHT ▶** arrow buttons. Test patterns are displayed in the following order:
White, Black, Red, Green, Blue, Checkerboard, CrossHatch, V Burst, H Burst, ColorBar, Aspect Ratios, Off
- Alternatively, open the OSD by pressing **MENU**. Highlight **Test Patterns** from the main menu, then select a test pattern using the **LEFT** and **RIGHT** arrow buttons.

After the final test pattern, the projector exits test pattern mode and returns to the main image. To view test patterns again, you need to press **TEST** again. If you wish to exit the test patterns before you reach the final one,

- press **TEST** or **EXIT** at any time.

Notes



For full details of how to use the controls and the menu system, see the [Operating Guide](#).

Adjusting the lens

The lens can be adjusted using the **Lens** menu, or using the lens buttons on the remote control.

Lens menu

The **Lens** menu provides access to the **Lens Control** setting and the **Lens Center** command.

Lens Control allows **Zoom**, **Focus** and **Shift** adjustment using the arrow buttons. The setting operates in **Zoom/Focus Adjustment** and **Shift Adjustment** mode.

Press **ENTER/SELECT** to switch between the two modes.

Remote control

Use the remote control to adjust zoom, focus and shift directly, without opening a menu:

- **OK** enters lens control, then switches between **Zoom/Focus Adjustment** and **Shift Adjustment**.
- **EXIT** exits lens control and opens the **Lens** menu.
- **MENU** exits lens control and returns to the main image.
- The arrow buttons adjust zoom, focus and shift as indicated on the screen.

Adjusting the image

Orientation

- This can be set from the **Setup** menu.

Highlight **Orientation** and choose from **Front Tabletop**, **Front Ceiling**, **Rear Tabletop**, **Rear Ceiling** and **Auto-front**.

Geometry

- Settings such as **Keystone**, **Rotation**, **Pincushion / Barrel** and **Arc** can be set from the **Geometry** menu.

Picture

- Settings such as **Gamma**, **Brightness**, **Contrast**, **Saturation**, **Hue** and **Sharpness** can be set from the **Image** menu.

Notes



For full details of how to adjust the lens using the remote control, see [Remote Control](#) earlier in this guide.

Setup menu

Geometry menu

Image menu

This page is intentionally left blank.



M-Vision Laser 18K Series

High Brightness Digital Video Projector

▶ CONNECTION GUIDE



IN THIS GUIDE

SIGNAL INPUTS AND OUTPUTS25

- Digital inputs and outputs25
- EDID on the DisplayPort, HDMI and HDBaseT inputs26
- Using DisplayPort/HDMI/HDBaseT switchers with the projector26
- 3D connections**27
 - Frame sequential 1080p and WUXGA 3D sources at 100 and 120 Hz27
 - Dual Pipe 1080p, WUXGA and WQXGA 3D sources at 100 and 120 Hz.....27
- 3D Sync**28
 - 3D Sync In28
 - 3D Sync Out.....28

CONTROL CONNECTIONS29

- LAN connection examples30
- RS232 connection example31

Signal Inputs and outputs

Digital inputs and outputs

- 1 HDBaseT**
Receives digital signal from HDBaseT-compliant devices.
- 2 HDMI 1**
HDMI 1.4a.
- 3 DisplayPort 1 / DisplayPort 2**
DisplayPort 1.1a.
- 4 3G-SDI in / 3G-SDI out**
From the **3G-SDI out** port, connect a 3G-SDI cable to distribute the 3G-SDI signal to another projector.
- 5 HDMI 2**
HDMI 1.4a.

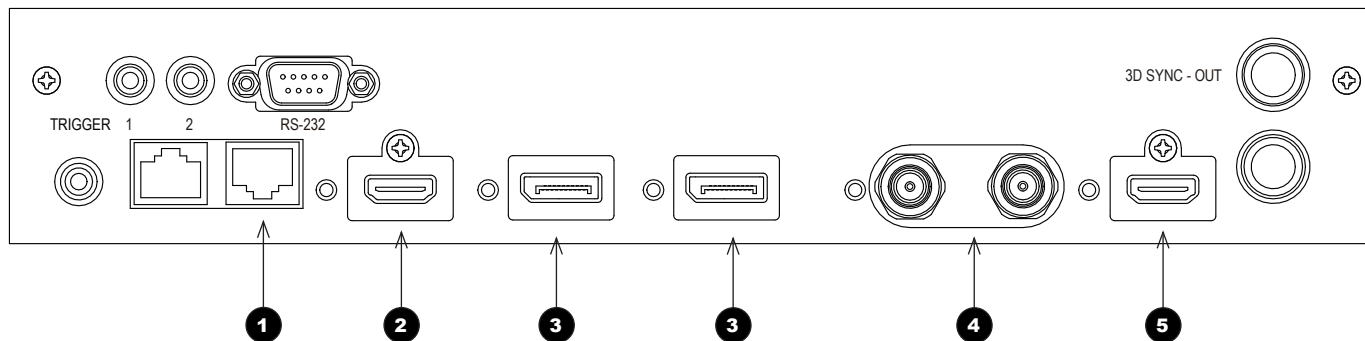

Notes

 For simultaneous HDBaseT and LAN connectivity, a third-party distribution product can be utilised to combine HDBaseT video stream with LAN connection for delivery to the projector.

EDID on the DisplayPort, HDMI and HDBaseT inputs

If you are using a computer graphics card or another source that obeys the EDID protocol, the source will automatically configure itself to suit the projector.

Otherwise refer to the documentation supplied with the source to manually set the resolution to the DMD™ resolution of the projector or the nearest suitable setting. Switch off the source, connect to the projector, then switch the source back on again.

Using DisplayPort/HDMI/HDBaseT switchers with the projector

When using a DisplayPort/HDMI/HDBaseT source switcher with the projector, it is important to set the switcher so that it passes the projector EDID through to the source devices. If this is not done, the projector may not be able to lock to the source or display the source correctly as its video output timings may not be compatible with those of the projector. Sometimes this is called transparent, pass-through or clone mode. See your switcher's manual for information on how to set this mode.

Notes

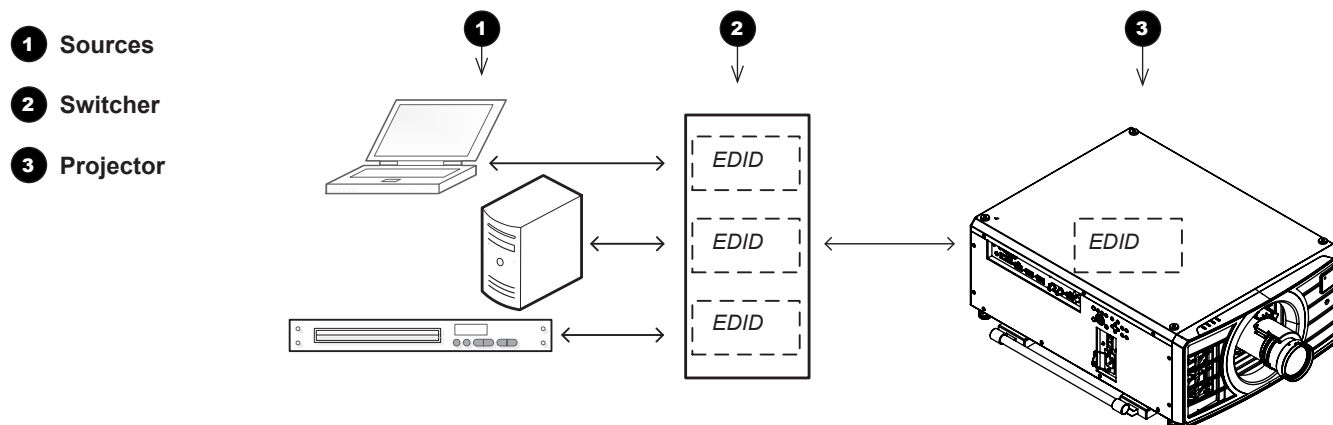

The EDIDs in the switcher should be the same as the one in the projector.

3D connections

Frame sequential 1080p and WUXGA 3D sources at 100 and 120 Hz

1. Connect to a DisplayPort input.
2. Set **3D Format** in the **3D** menu to **Frame Sequential**.

Dual Pipe 1080p, WUXGA and WQXGA 3D sources at 100 and 120 Hz

1. Connect the left eye output to the **HDMI 1** socket and the right eye output to the **HDMI 2** socket.
2. Set **3D Format** in the **3D** menu to **Dual-Pipe**.

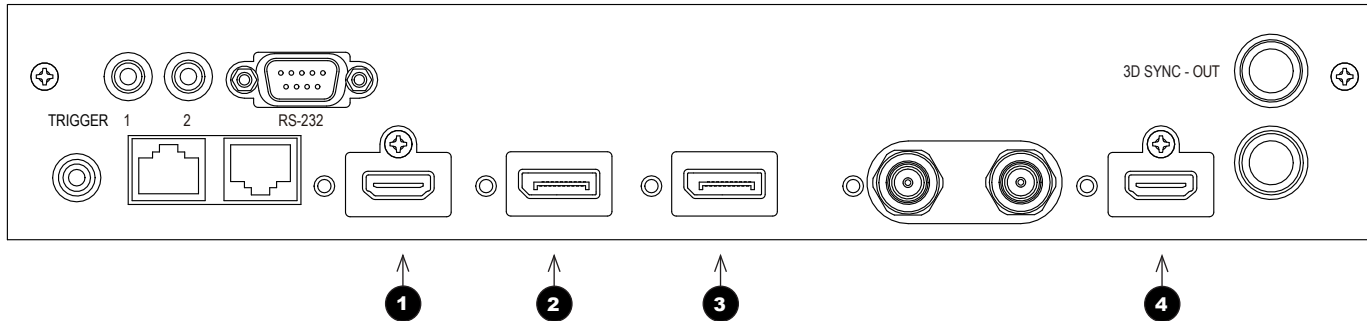

- 1** HDMI 1 / Dual Pipe LEFT
- 2** DisplayPort 1
- 3** DisplayPort 2
- 4** HDMI 2 / Dual Pipe RIGHT

Notes

 See [3D formats](#) in the *Reference Guide* for a complete list of supported formats and frame rates.

 While the projector can receive 100/120Hz and display 3D at 100/120Hz, video processing is limited to 60Hz.

This also applies to Dual Pipe 3D at 60 Hz per input.

3D Sync

3D Sync In

Sync input signal. Connect the 3D sync from your graphics card or server.

3D Sync Out

Sync output signal. This may be affected by the **Sync Offset** setting in the **3D Control** menu.

Connect this to your IR emitter or ZScreen.

Notes

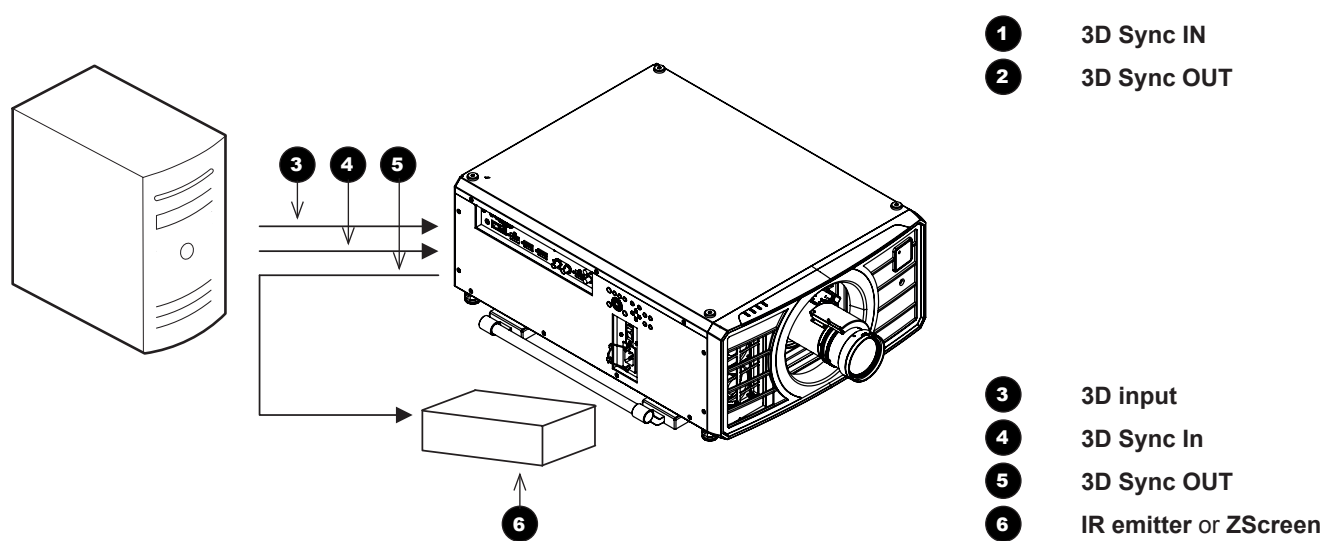
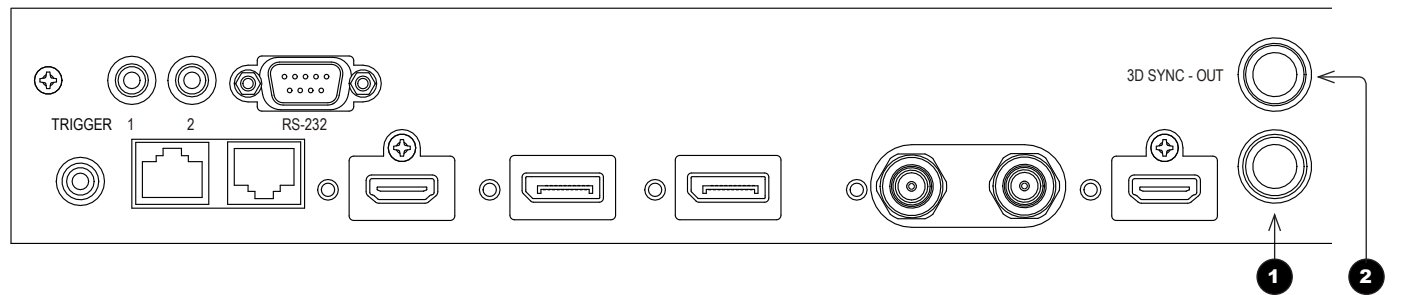

Control Connections

1 Trigger 1

2 Trigger 2

The Trigger outputs are activated by one of the three following conditions, as set in the **Setup** menu:

- Screen trigger: can be connected to an electrically operated screen, automatically deploying the screen when the projector starts up, and retracting the screen when the projector shuts down.
- Aspect ratio trigger: can be used to control screen shuttering for different aspect ratios.
- RS232 trigger: can be used to control the screen or screen shuttering on receipt of an RS232 command

3 RS232

- All of the projector's features can be controlled via a serial connection, using commands described in the **Protocol Guide**.
- Use a straight-through cable to connect directly to a computer.

4 Wired Remote

The remote control can be connected using a standard 3.5 mm mini jack cable (tip-ring-sleeve, or TRS).

5 LAN

This dedicated LAN connection can be used if **HDBaseT/LAN** is already being used for HDBaseT signal input.

6 HDBaseT/LAN

The projector's features can be controlled via a LAN connection, using Digital Projection's **Projector Controller** application or a terminal-emulation program.

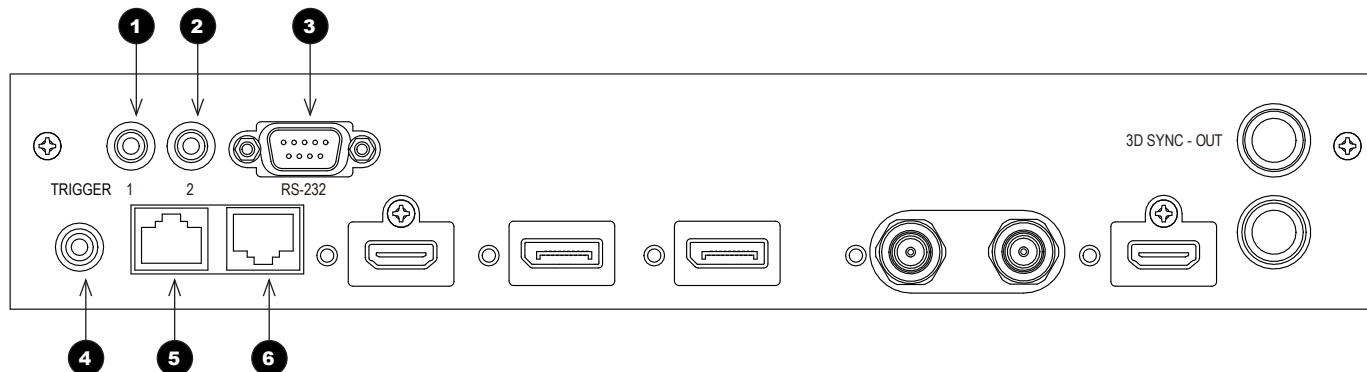



Notes

 For a list of all commands used to control the projector via LAN, see the **Protocol Guide**.

 Only one remote connection (RS232 or LAN) should be used at any one time.

 With a LAN connection the projector can serve a web page offering basic projector controls.

 **Trigger 1** and **Trigger 2** are not available with HDMI 3 and 4 inputs.



 **Projector Controller** is available for download, free of charge, from the Digital Projection website.

LAN connection examples

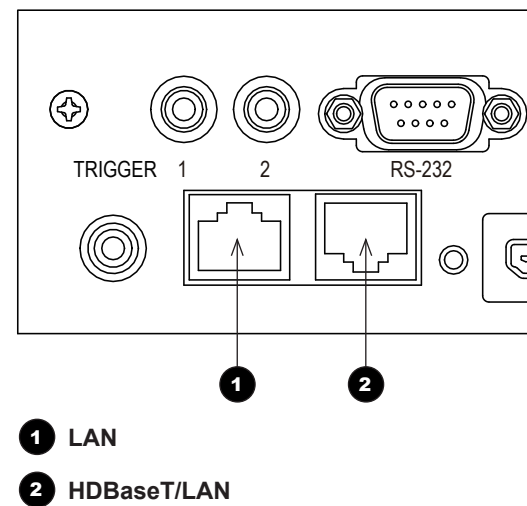
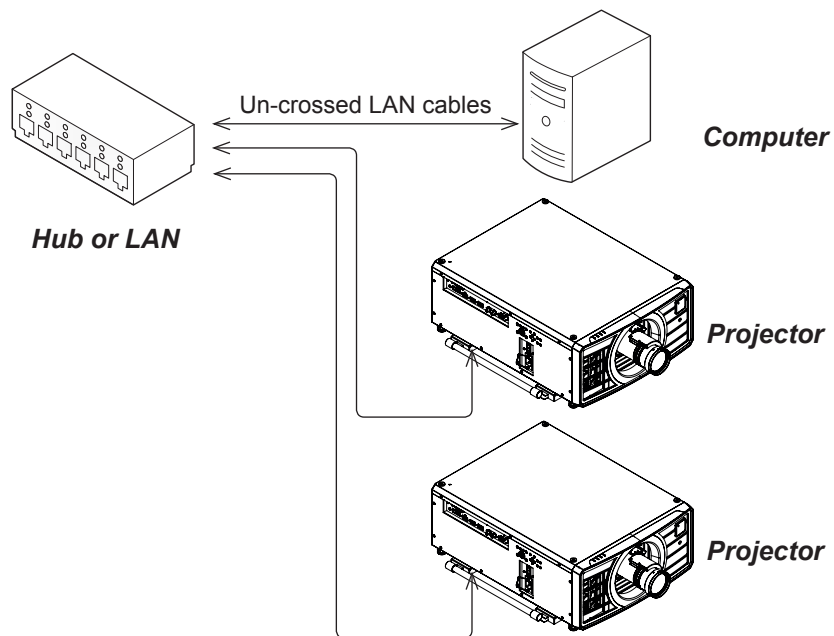
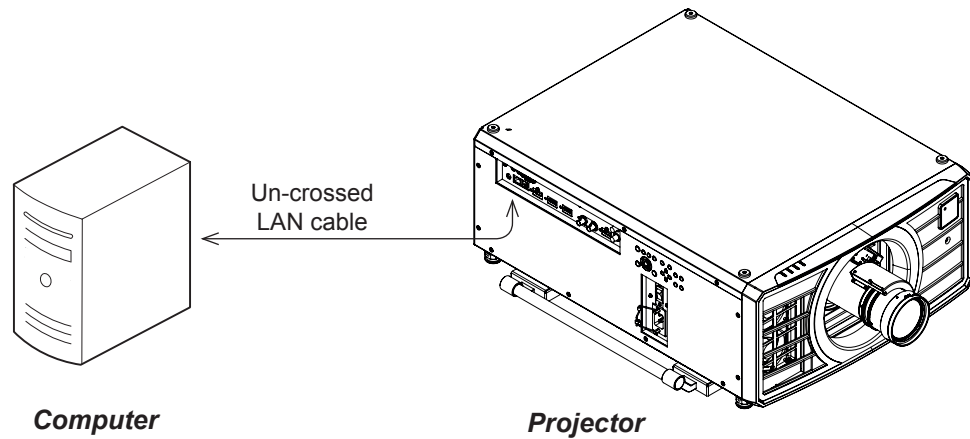
The projector's features can be controlled via a LAN connection, using Digital Projection's **Projector Controller** application or a terminal-emulation program



Notes

-  With a LAN connection the projector can serve a web page offering basic projector controls.
-  **Projector Controller** is available for download, free of charge, from the Digital Projection website.
-  For simultaneous HDBaseT and LAN connectivity, a third-party distribution product can be utilised to combine HDBaseT video stream with LAN connection for delivery to the projector.

RS232 connection example

All of the projector's features can be controlled via a serial connection, using commands described in the *Protocol Guide*.

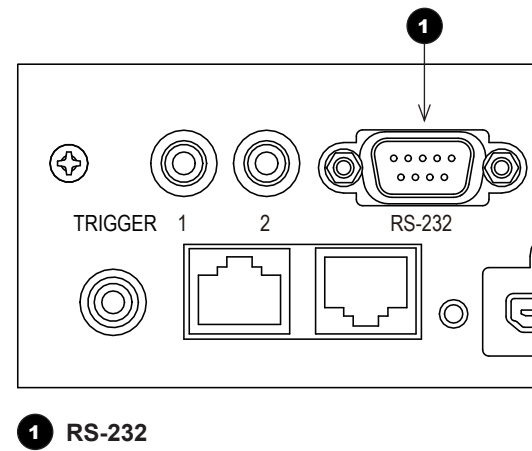
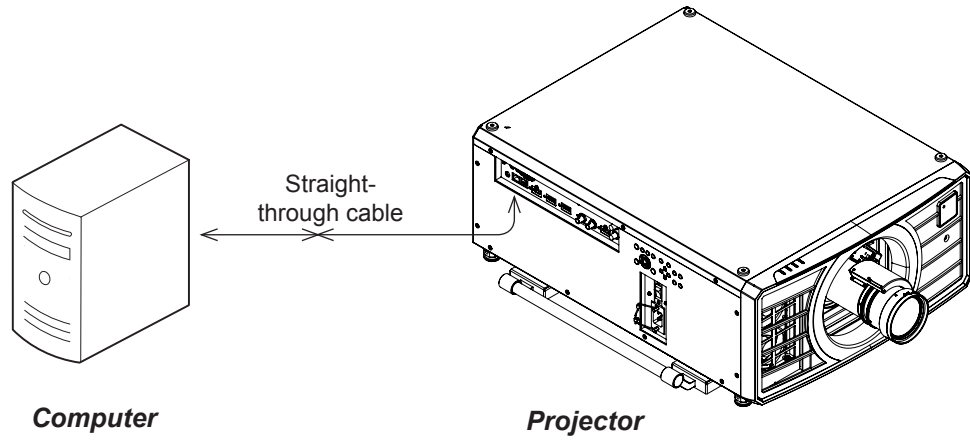

Notes

 The *Protocol Guide* is available separately.

This page is intentionally left blank.



M-Vision Laser 18K Series

High Brightness Digital Video Projector

▶ OPERATING GUIDE



CONTENTS

USING THE MENUS 35

OPENING THE OSD 35

OPENING A MENU 35

EXITING MENUS AND CLOSING THE OSD 35

INSIDE A MENU 36

 Accessing sub-menus 36

 Executing commands 36

EDITING PROJECTOR SETTINGS 37

 Using a slider to set a value 37

 Editing numeric values 37

USING THE PROJECTOR 38

MAIN MENU 38

LENS MENU 39

 Lens Control 39

 Lens Memory 40

IMAGE MENU 41

COLOR MENU 42

 Color Space 42

 Color Mode 43

GEOMETRY MENU 48

 Aspect Ratio 48

 Digital Zoom 50

 Overscan 51

 Blanking 52

 Keystone 53

 4 Corners 55

 Rotation 56

 Pincushion / Barrel 57

 Arc 58

 Custom Warp 58

EDGE BLEND MENU 59

 Blend Width 60

 Black Level Uplift 61

3D MENU 62

 3D types 63

 Some 3D settings explained 65

LASER MENU 66

SETUP MENU 67

 ColorMax Setting 69

 Power On/Off 70

 Clock Adjust 71

 OSD Settings 72

 Memory 72

NETWORK MENU 73

PIP MENU 74

INFORMATION MENU 75

 Signal Format 75

 System Status 76

 Thermal Status 76

 Factory Reset 77

Using The Menu

Opening the OSD

Access the various menus using either the projector control panel or the remote control. On either device,

- press the **MENU** button.

The on-screen display (OSD) opens showing the list of available menus.

Opening a menu

Move up and down the list using the **UP ▲** and **DOWN ▼** arrow buttons. To open a menu,

- press **ENTER** on the control panel or **OK** on the remote control.

This guide refers to the above two buttons as **ENTER/OK**.

Exiting menus and closing the OSD

To go back to the previous page,

- press **EXIT**.

When you reach the top level, pressing **EXIT** will close the OSD.

To close the OSD from any page,

- press **MENU**.

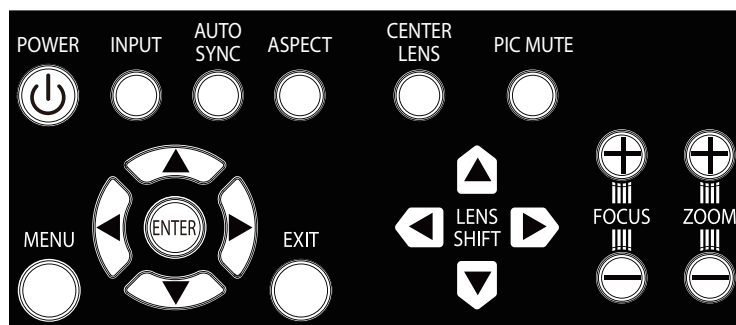

Projector control panel



Remote control

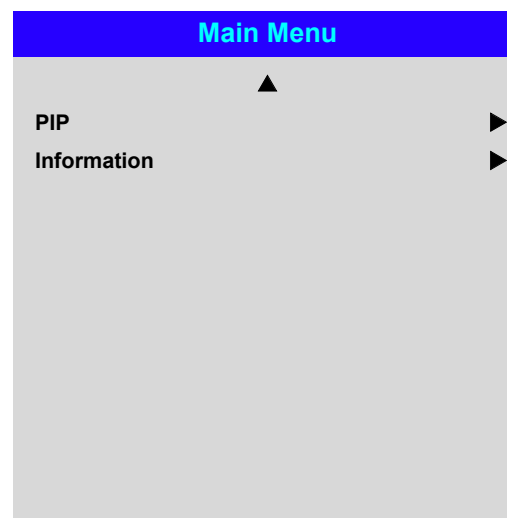
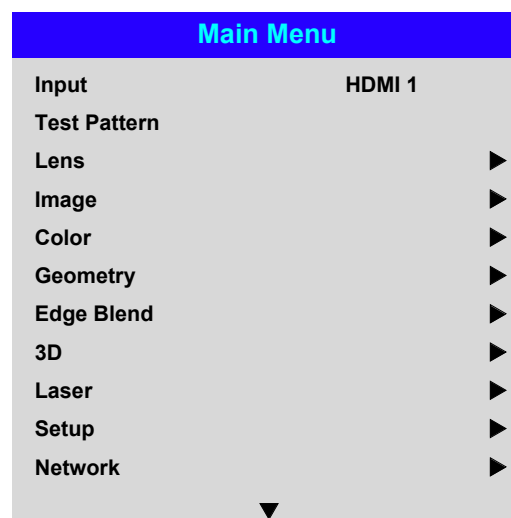

On-screen display (OSD): top level menus

Notes

Inside a menu

When you open a menu, the page consists of the following elements:

- Title bar at the top
Shows which menu you have accessed.
- Highlighted item
- Available and unavailable items
Unavailable items appear a pale gray color. Whether an item is available may depend on other settings.
- The text or symbol to the right of an item shows whether the item:
 - has a value that can be changed (the current value is shown)
 - opens a sub-menu (an arrow button ► is displayed)
 - executes a command (the space to the right of the item is blank).

Accessing sub-menus

Use the **UP ▲** and **DOWN ▼** arrow buttons to highlight the sub-menu, then press **ENTER/OK**.

Executing commands

If the item contains a command, highlighting it reveals an **OK** button.

Press **ENTER/OK** to execute the highlighted command.

You may be asked for confirmation. Use the **ENTER/OK** to confirm, or **EXIT** to cancel.

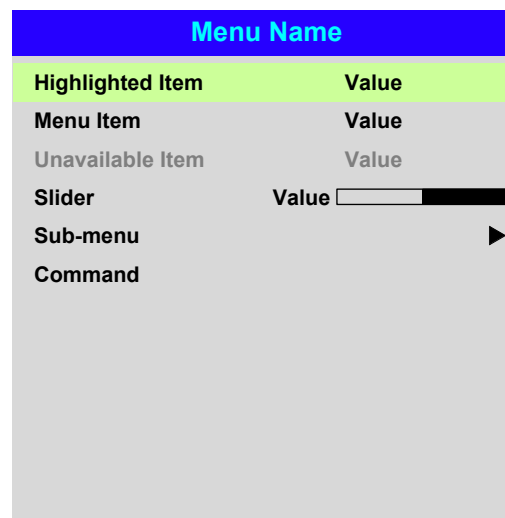

Inside a menu

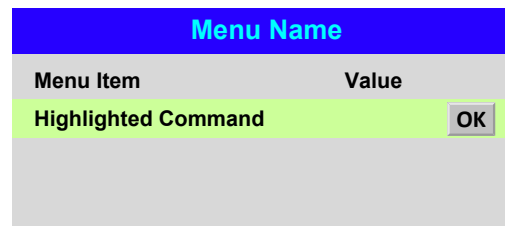

Highlighted command

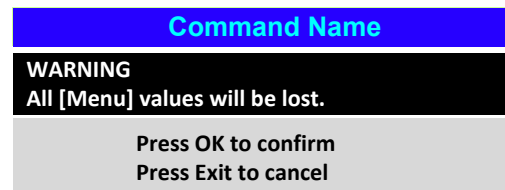

Confirmation dialog

Notes



The highlighted item has green background.

Editing projector settings

If the highlighted menu item contains a list of values to choose from, you can change the value by doing the following:

1. Highlight the menu item and press **ENTER/OK**.
2. In the list of values that opens, use the **UP ▲** and **DOWN ▼** arrow buttons to highlight a value, then press **ENTER/OK** again to select the highlighted value.

Using a slider to set a value

Some parameters open a slider. To set such a parameter:

1. Press the **LEFT ◀** or **RIGHT ▶** arrow button, or **ENTER/OK**. The arrow buttons will open the slider and adjust the value at the same time. **ENTER/OK** will open the slider without altering the initial value.
2. Use the **LEFT ◀** and **RIGHT ▶** arrow buttons to move the slider.
3. When ready, press **EXIT** to exit the slider and return to the menu, or press **MENU** to exit the slider without showing the menu again.

Editing numeric values

Some parameters take numeric values without using sliders - for example, color matching values or IP addresses.

1. Use the **UP ▲** and **DOWN ▼** arrow buttons to highlight the row containing the numeric field you wish to edit.
2. Press **ENTER/OK** to enter edit mode. A numeric field in edit mode is white text on blue background.
3. In edit mode:
 - Use the **UP ▲** arrow button to increase the numeric value.
 - Use the **DOWN ▼** arrow button to decrease the numeric value.
4. Use the **LEFT ◀** and **RIGHT ▶** arrow buttons to edit the next or previous numeric fields within the same row.
5. Once ready, press **ENTER/OK** to exit edit mode.

Menu Name	
Highlighted Item	Current Value
Menu Item	Highlighted Value
Menu Item	Value
	Value
	Value

List of values

Parameter	Value
	<input type="text"/>

Slider

Data		
Row	x: 0.658	y: 0.339
Highlighted Row	x: 0.315	y: 0.662
Row	x: 0.146	y: 0.043
Row	x: 0.276	y: 0.283

Numeric values

Notes



Some menu items may be unavailable due to settings in other menus. Unavailable menu items appear gray.

Using The Projector

Main menu

- Input**
 Press **ENTER/OK** to open the list of available inputs.
 Use the **UP ▲** and **DOWN ▼** arrow buttons to select an input from the list, then press **ENTER/OK** to confirm your choice.
 Press **EXIT** to return to the main menu.
- Test Pattern**
 Choose from:
...Off, White, Black, Red, Green, Blue, Cyan, Yellow, Magenta...
 Use the **LEFT ◀** and **RIGHT ▶** arrow buttons to switch between values.
- Lens, Image, Color, Geometry, Edge Blend, 3D, Laser, Setup and Network**
 Press **ENTER/OK** to open these menus and access various settings.

Press the **DOWN ▼** arrow at the bottom of the page to access additional menus:

- PIP and Information**
 Press **ENTER/OK** to open these menus and access various settings.

Press the **UP ▲** arrow to return to the previous page.

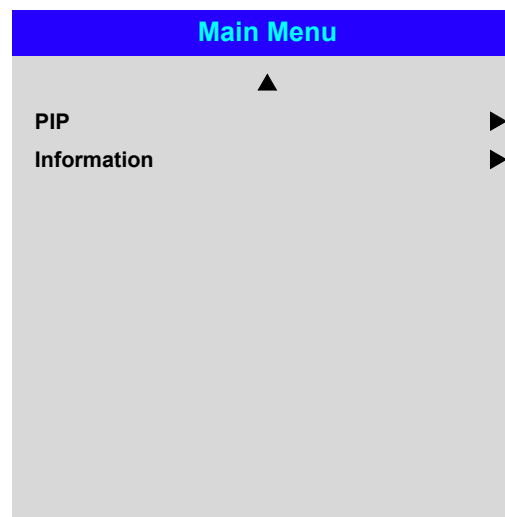
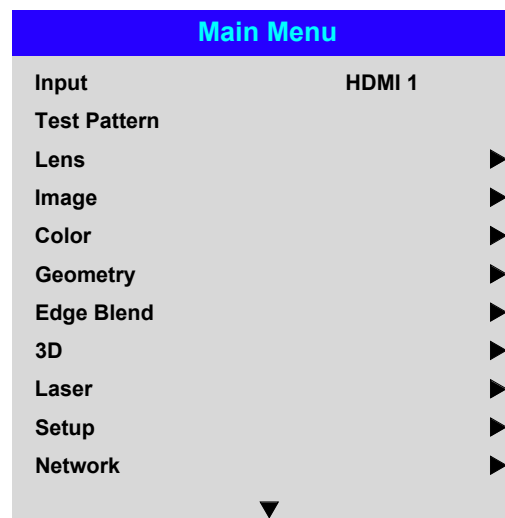

Main menu, page 1 and 2

Notes

 See [Signal Inputs](#) in the [Connection Guide](#) for further information about the available inputs and connections.

 Selecting a test pattern hides the OSD. Press **EXIT** to hide the test pattern, and then press **MENU** to show the OSD.

Lens menu

- Lens Lock**
 When this feature is **On**, all other **Lens** menu items are disabled.
- Lens Control**
 Opens a sub-menu, see below.
- Center Lens**
 Centers the lens.
- Lens Memory**
 Opens a sub-menu, see next page.

Lens Control

Lens Control settings operate in **Zoom/Focus Adjustment** and **Shift Adjustment** mode. Press **ENTER/OK** to switch between modes.

When in **Zoom/Focus Adjustment** mode:

- Use the **UP ▲** and **DOWN ▼** arrow buttons to adjust **Zoom**.
- Use the **LEFT ◀** and **RIGHT ▶** arrow buttons to adjust **Focus**.

When in **Shift Adjustment** mode, use the arrow buttons to adjust **Shift**.

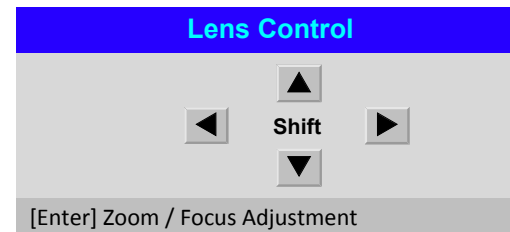
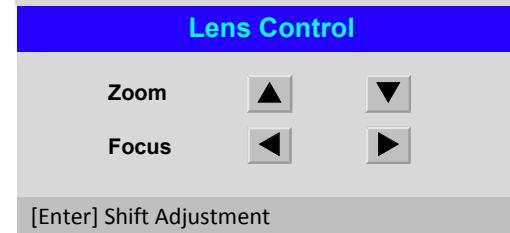
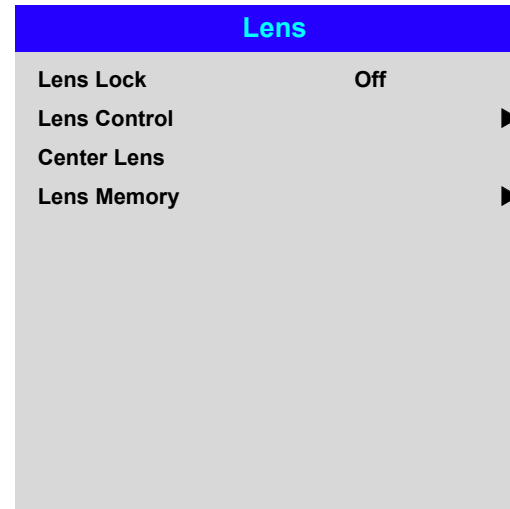

Notes

Lens menu continued from previous page

Lens Memory

This menu allows you to load, save and delete up to ten lens presets, containing position, zoom, focus and shift adjustment information.

For example, if using different screen sizes and aspect ratios, you can save zoom, focus and positioning for each screen size and aspect ratio in a dedicated preset.

Use **Clear Memory** to delete a memory preset if you need to save a new combination of lens settings in its place. Overwriting a saved memory preset is not possible.

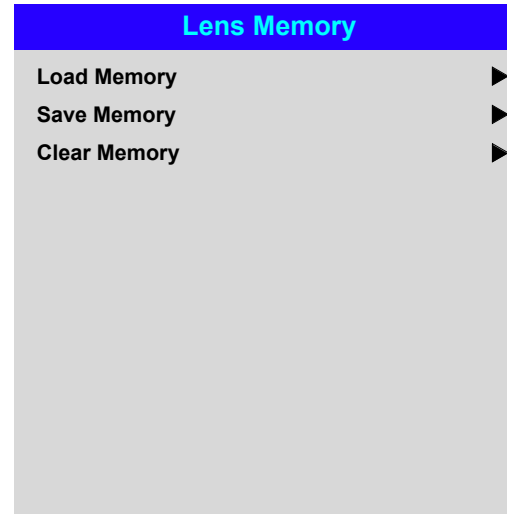

Notes

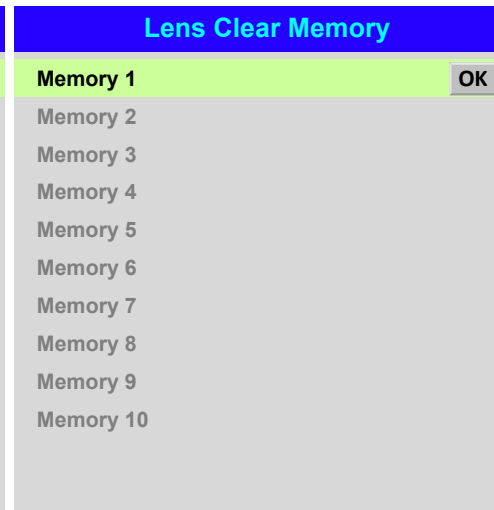
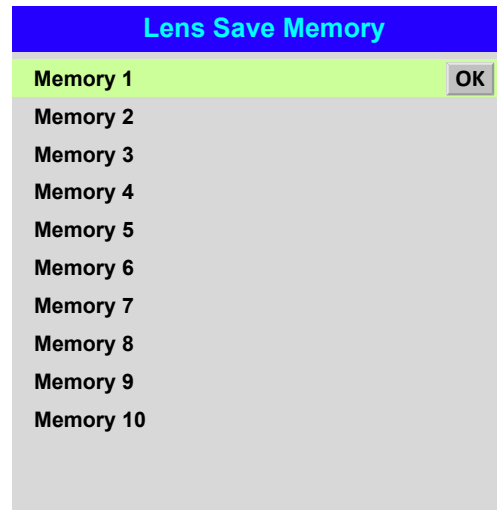
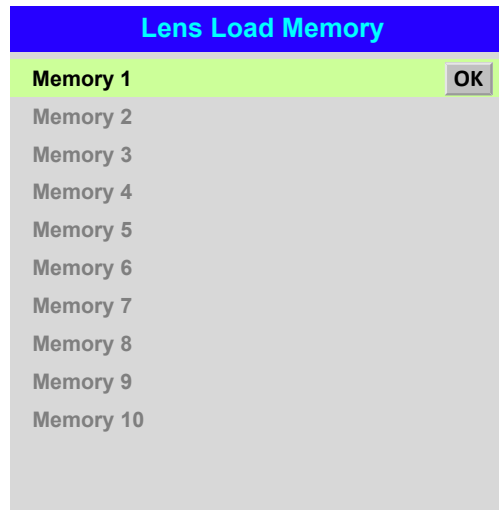

Image menu

- Picture Mode**
 Choose from **High Bright**, **Presentation** and **Video**.
 Use a different setting depending the type of input source.
 Press **ENTER/SELECT** to open the list.
 Use the **UP ▲** and **DOWN ▼** arrow buttons to select a picture mode from the list, then press **ENTER/OK** to confirm your choice.
 Press **EXIT** to return to the main menu.
- Dynamic Black**
 Set to **On** to allow for increased contrast in darker scenes by modulating the light source.
- Light Off Timer**
 When Dynamic Black is **On**, the Laser light source may turn off depending upon the setting of the **Light Off Timer**. Options are: Disable, 0.5, 1.0, 1.5, 2.0, 3.0, 4.0 seconds.
- Gamma**
 Choose a de-gamma curve from **1.0**, **1.8**, **2.0**, **2.2**, **2.35**, **2.5**, **S-Curve** and **DICOM**.
 Used correctly, the **Gamma** setting can improve contrast while maintaining good details for blacks and whites.
 If excess ambient light washes out the image and it is difficult to see details in dark areas, lower the **Gamma** setting to compensate. This improves contrast while maintaining good details for blacks. Conversely, if the image is washed out and unnatural, with excessive detail in black areas, increase the setting.
S-Curve is an enhanced mid-tone gamma.
DICOM is a simulated DICOM display, which can be used for training applications.
- Brightness, Contrast, Saturation, Hue, Sharpness, Noise Reduction**
 Highlight the setting you wish to edit, and then press **ENTER/OK**, or the **LEFT ◀** or **RIGHT ▶** arrow button to open the slider.
 Use the **LEFT ◀** and **RIGHT ▶** arrow buttons to adjust the slider.
 Press **EXIT** to close the slider and return to the menu, or **MENU** to close the slider and return to the projected image.
- Freeze**
 Freezes the current frame.
- Resync**
 Press **ENTER/OK** to force the projector to resynchronise with the current input.



Notes

Color menu

Color Space

In most cases, the **Auto** setting determines the correct colorspace to use. If it does not, you can choose a specific colorspace:

Choose from **Auto**, **YPbPr**, **YCbCr**, **RGB PC** and **RGB Video**.

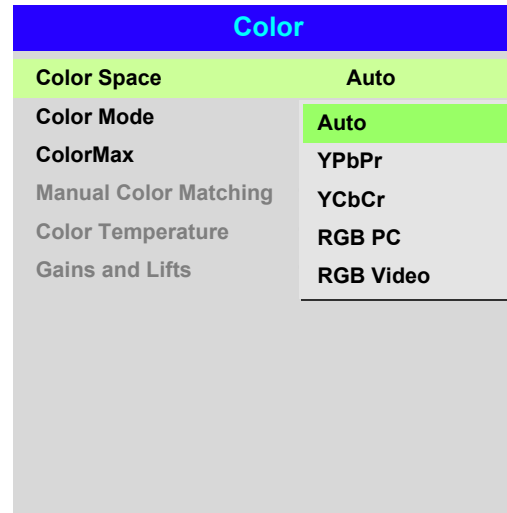
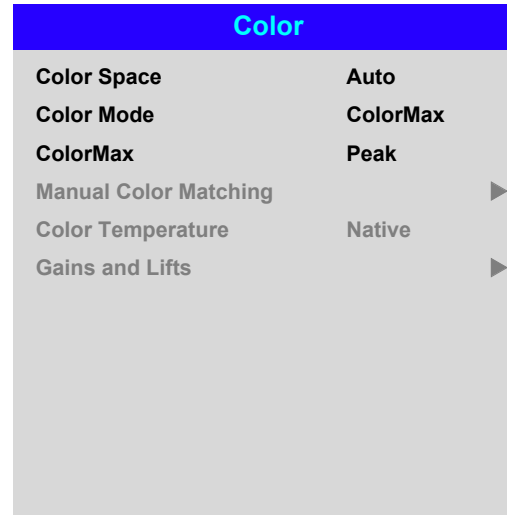

Notes

Color Mode

The projector can work in the following color modes: **ColorMax**, **Manual Color Matching**, **Color Temperature** and **Gains and Lifts**.

Color	
Color Space	Auto
Color Mode	ColorMax
ColorMax	ColorMax
Manual Color Match	Manual Color Matching
Color Temperature	Color Temperature
Gains and Lifts	Gains and Lifts

ColorMax

1. Set **Color Mode** to **ColorMax**.
 2. Navigate to the **ColorMax** setting. Choose from **HDTV**, **Peak**, **User 1** and **User 2**.
- User 1** and **User 2** are user-defined color gamuts set via the **Setup > ColorMax** menu.

Color	
Color Space	Auto
Color Mode	ColorMax
ColorMax	Peak
Manual Color Matching	HDTV
Color Temperature	Peak
Gains and Lifts	User 1
	User 2

Notes

 Only one color mode can be selected at a time. Settings used by the other color modes are disabled.

 See [Setup menu](#) for further information about setting up the **User 1** and **User 2** color gamuts.

Color menu continued from previous page

Manual Color Matching

1. Set **Color Mode** to **Manual Color Matching**.
2. Open the **Manual Color Matching** submenu.

Here you can do the following:

- Switch **Auto Test Pattern On** and **Off**.
- Adjust **Hue**, **Saturation** and **Gain** settings for each individual color to improve the color balance of the projected image.
- Adjust white balance RGB values.
- Reset all values.

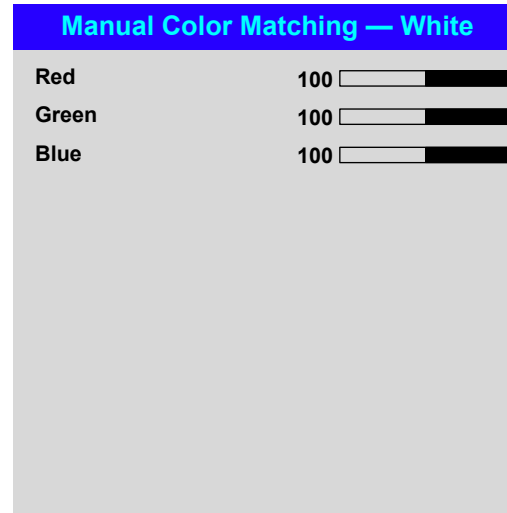
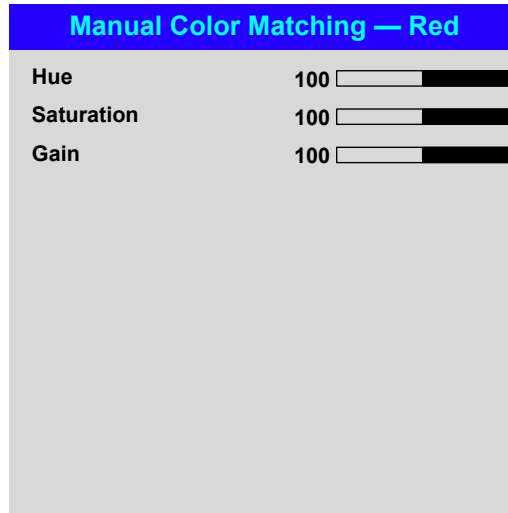
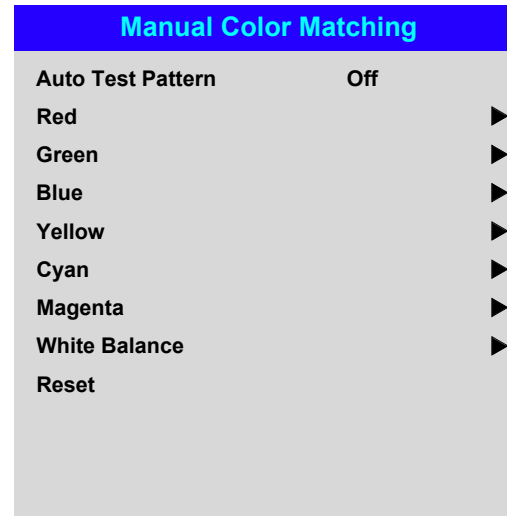

Notes

 For more details about the **Hue**, **Saturation** and **Gain** settings, see [Color matching parameters explained](#) further in this guide.

Color menu continued from previous page

Color matching parameters explained

The levels of hue, saturation and gain in the **Manual Color Matching** menu change the color values in the following ways:

- 1 Hue**
Specifies the position of each color (*red, yellow, green, cyan, blue* and *magenta*) relative to its neighboring colors.
- 2 Saturation**
Specifies the level of white in each color (i.e. how "pale" each color is).
- 3 Gain**
Controls the amount of light that goes into each color, i.e. the lowest gain would produce black.

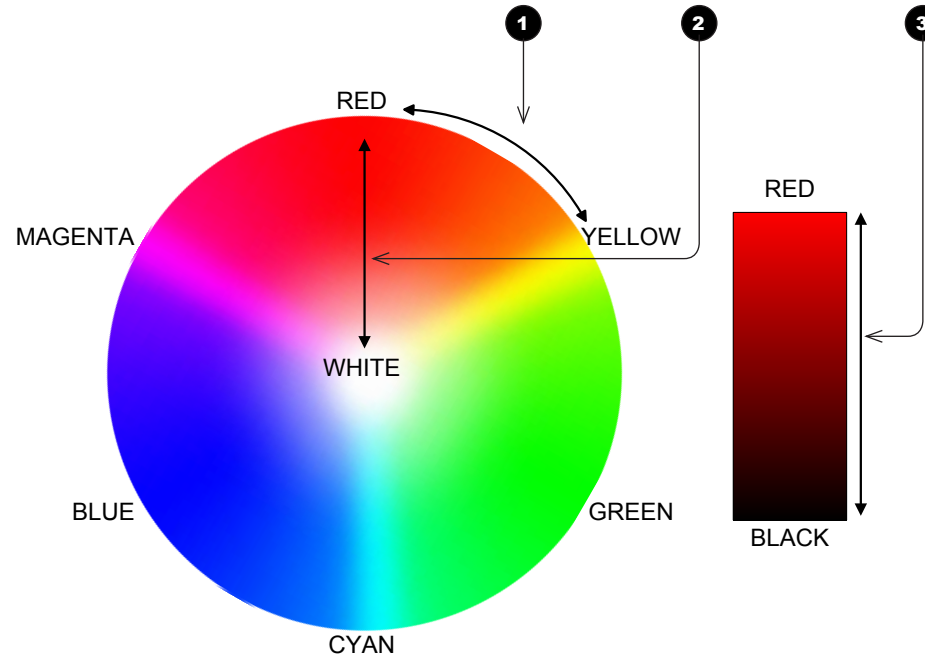

Notes

Color menu continued from previous page

Color Temperature

1. Set **Color Mode** to **Color Temperature**.
2. Navigate to the **Color Temperature** setting. Choose a value from **3200K** (warmer) to **9300K** (cooler) or **Native** (no correction).

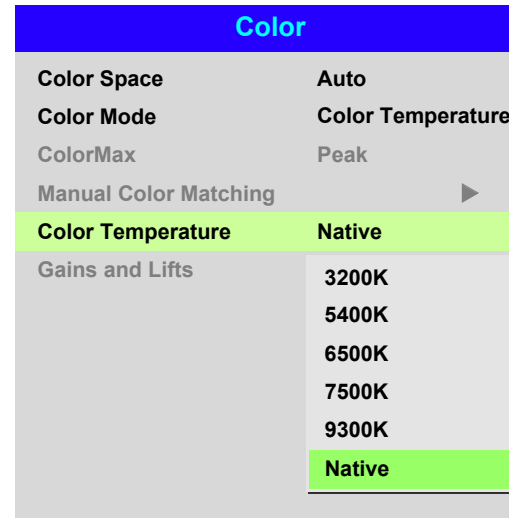

Notes

Color menu continued from previous page

Gains and Lifts

Lifts allow you to adjust black levels of individual colors, while gains adjust the bright part of the scale.

Set the sliders as required.

Gains and Lifts	
Red Lift	100 <input type="range"/>
Green Lift	100 <input type="range"/>
Blue Lift	100 <input type="range"/>
Red Gain	100 <input type="range"/>
Green Gain	100 <input type="range"/>
Blue Gain	100 <input type="range"/>
Reset	

Notes

Geometry menu

This menu allows you to compensate for image distortions caused by an unusual projection angle or irregular screen surface.

Geometry	
Aspect Ratio	Source
Digital Zoom	▶
Overscan	Off
Blanking	▶
Keystone	▶
4 Corners	▶
Rotation	▶
Pincushion / Barrel	▶
Arc	▶
Custom Warp	Off

Notes



Only one of the following should be used at any one time. **Keystone, 4 Corners, Rotation, Pincushion/Barrel** and **Arc**

For more complex adjustments use **Custom Warp** later in this section.

Aspect Ratio

This feature defines the aspect ratio of the source. Use the **Setup > Screen Setting** to define the screen aspect ratio.

If you choose a preset aspect ratio from here, it will give you the best fit for your selection.

Choose from:

- **5:4**
- **4:3**
- **16:10**
- **16:9**
- **1.88**
- **2.35**
- **TheaterScope**
- **Source**
- **Unscaled**



Image scaling and aspect ratio are also influenced by **Setup > Screen Setting**.



See next page for further information about the **TheaterScope** aspect ratio.

Theaterscope setting

The **TheaterScope** setting is used in combination with an anamorphic lens to restore 2.35:1 images packed into a 16:9 frame. Such images are projected with black lines at the top and bottom of the 16:9 screen to make up for the difference in aspect ratios.

Without an anamorphic lens and without the TheaterScope setting applied, a 16:9 source containing a 2.35:1 image looks like this:

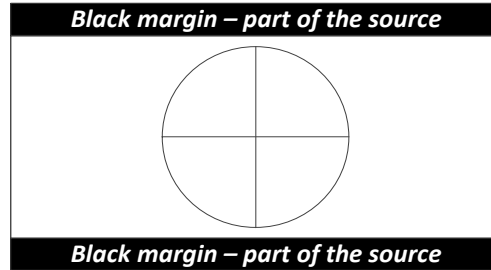

If we change the setting to **TheaterScope**, the black lines will disappear but the image will stretch vertically to reach the top and bottom of the DMD™:

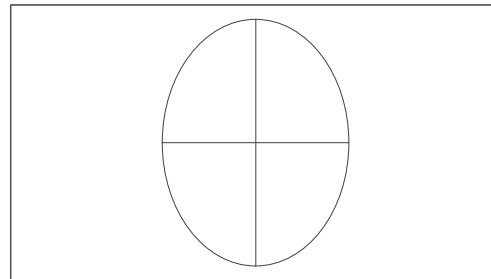

An anamorphic lens will stretch the image horizontally, restoring the original 2.35 ratio:

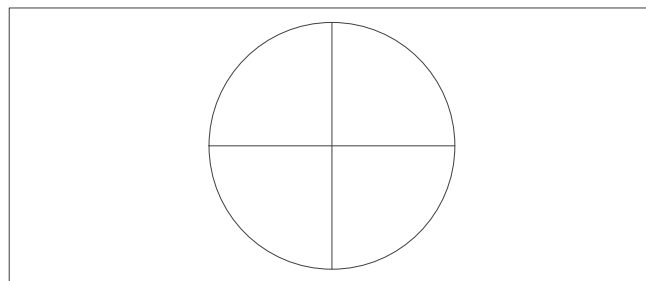

Notes

 TheaterScope is used with an anamorphic lens.

 If you use TheaterScope, set the screen aspect ratio to 16:9.

.Geometry menu continued from previous page

Digital Zoom

Digital zooming enlarges a section of the image, while the area outside the enlarged section is cropped out to preserve the overall image size.

- **Digital Zoom** defines the level of zoom that needs to be applied. If **Digital Zoom** is set to **0**, then the other settings in the menu will be disabled.
- **Digital Pan** and **Digital Scan** specify the area that is being enlarged:
 - **Digital Pan** adjusts the horizontal coordinates.
 - **Digital Scan** adjusts the vertical coordinates.

The **Reset** command restores the default **Digital Zoom**, **Digital Pan** and **Digital Scan** values.

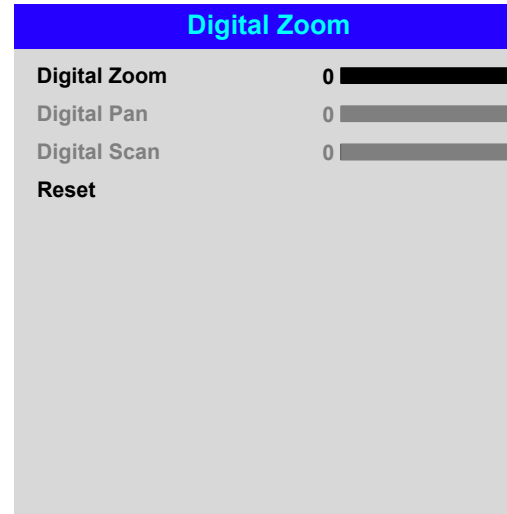

Notes

Geometry menu continued from previous page

Overscan

Use this setting to compensate for noisy or badly defined image edges.

Crop removes unwanted artifacts from the edges of your image by cropping the edges.

Zoom increases the size of the image to force the edges off-screen.

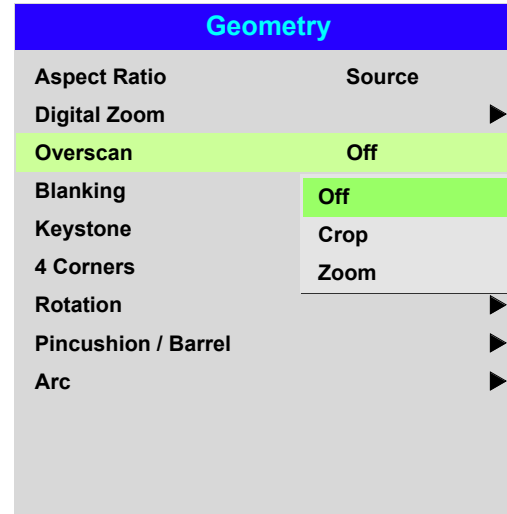

Notes



Image with noisy edges



Overscanned image

Geometry menu continued from previous page

Blanking

Use this feature to:

- fit an odd-sized screen;
- cut off timecode dots in the top line of a picture;
- cut off subtitles, etc.

Select the edge you wish to blank and use the **LEFT** ◀ and **RIGHT** ▶ arrow buttons to determine the amount of correction.

Use the **Reset** command to restore blanked edges.

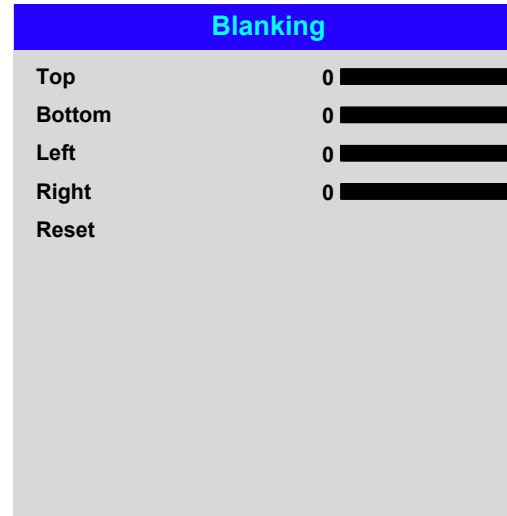

Notes

Geometry menu continued from previous page

Keystone

Use this setting to compensate for any distortion caused by the projector being in a different horizontal or vertical plane to the screen.

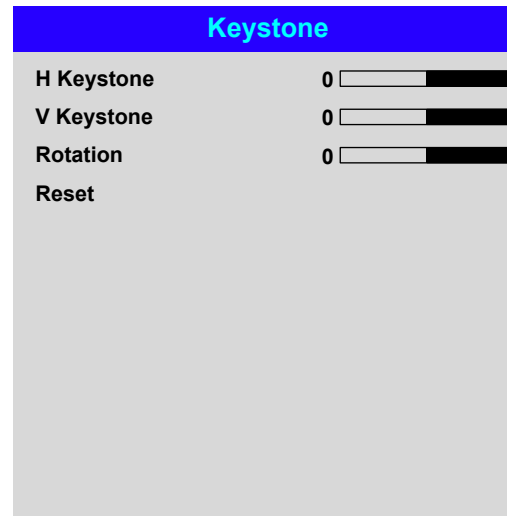

Notes

Keystone example

- 1 The projector is positioned at an angle
- 2 The resulting image is distorted
- 3 The image is corrected when Keystone is applied

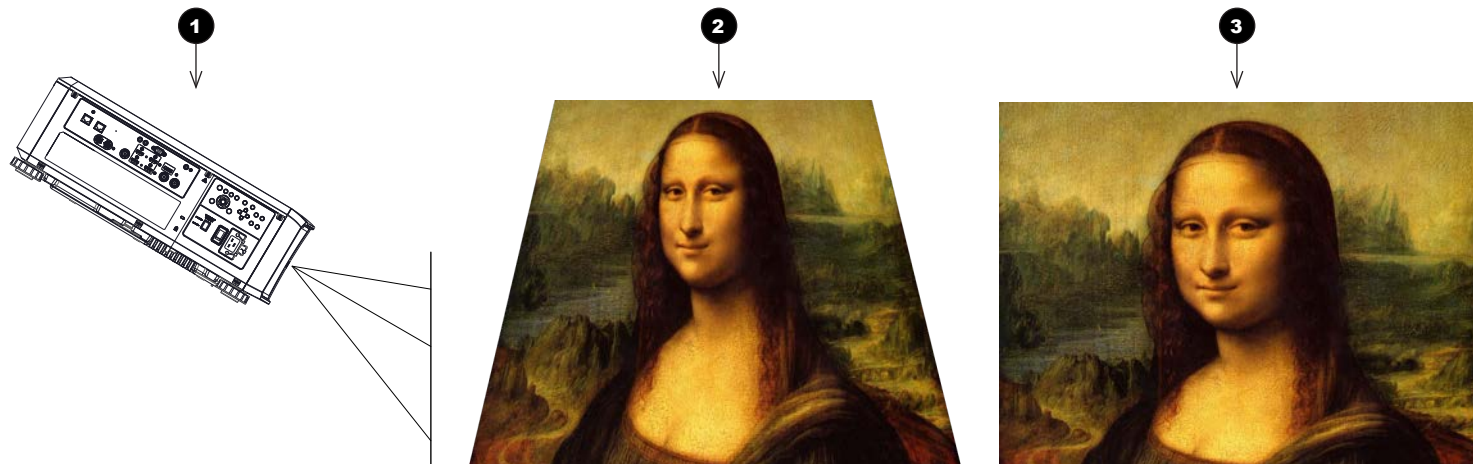

Geometry menu continued from previous page

Keystone settings

- 1 Projector to the left**
 The projector is positioned to the left of the screen.
 To correct, apply a positive **Horizontal Keystone** value using the **RIGHT** arrow button.
- 2 Projector to the right**
 The projector is positioned to the right of the screen.
 To correct, apply a negative **Horizontal Keystone** value using the **LEFT** arrow button.
- 3 Projector high**
 The projector is positioned above the screen at a downward angle.
 To correct, apply a negative **Vertical Keystone** value using the **DOWN** arrow button.
- 4 Projector low**
 The projector is positioned below the screen at an upward angle.
 To correct, apply a positive **Vertical Keystone** value using the **UP** arrow button.
- 5 Projector straight**
 The projector is directly opposite the screen at a right angle both horizontally and vertically.
 No correction is needed.

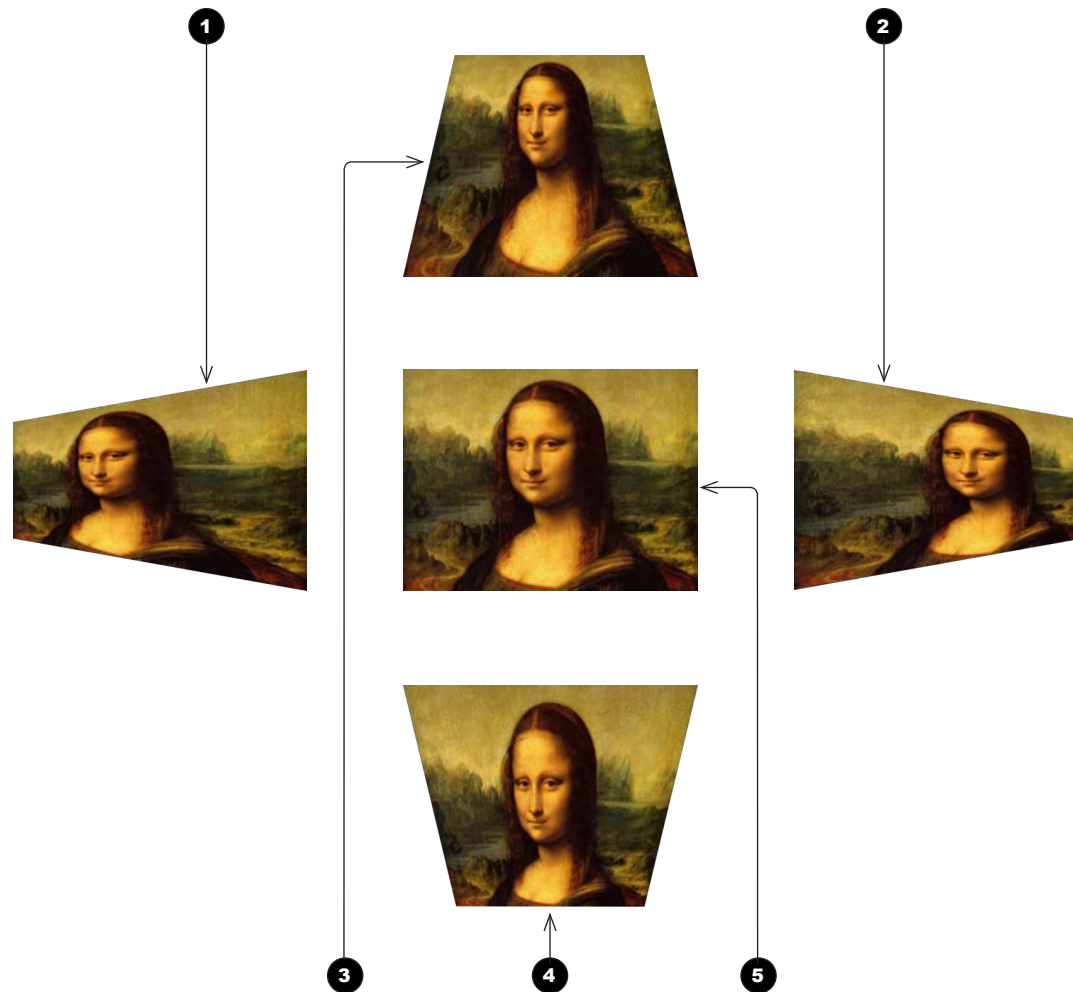

Horizontal and vertical keystone corrections

Notes

Geometry menu continued from previous page

4 Corners

For each corner, apply horizontal and / or vertical correction as necessary to restore the rectangular shape of the image.

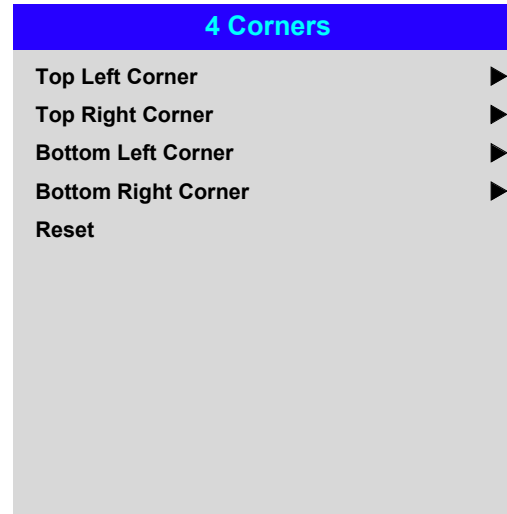

Top Right Corner example

In this illustration, the top right corner requires both horizontal and vertical correction.

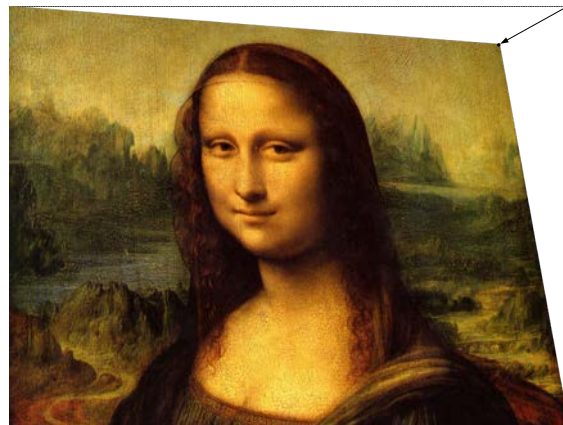

Top Right Corner correction



Notes

 Corner corrections provide a simple setup for awkward installations and irregular shaped screens that may distort the image. To apply a similar (but less flexible) correction, while preserving the original aspect ratio of the image, use the **Keystone** menu.

Geometry menu continued from previous page

Rotation

Use this feature for example to correct a mounting error causing the image not to be level with the screen.

Rotation example

- 1 **DMD™ area**
The DMD™ is not rotated. It still covers the area that would be occupied by the image without correction.
- 2 **Rotated image**
The image is smaller than the surrounding DMD™ area. It is scaled in order to remain within the DMD™ area.
- 3 **Angle of rotation**
The angle equals a quarter of the **Rotation** setting.
In this example the angle is 5°, therefore **Rotation = 20**.

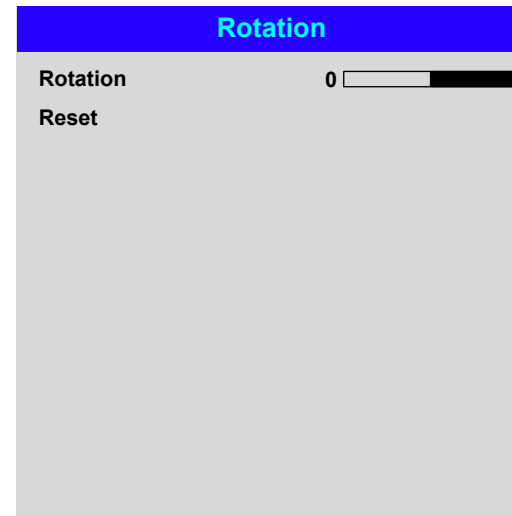
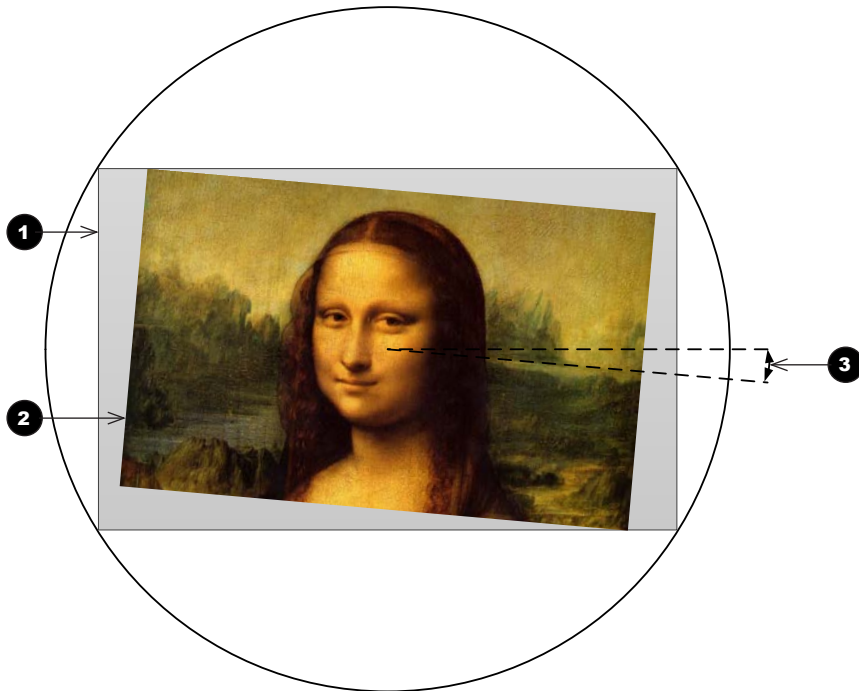

Notes

Geometry menu continued from previous page

Pincushion / Barrel

Pincushion or barrel distortions are the result of poor or incorrect tensioning of the screen or using a surface that is not flat.

Use the **Pincushion / Barrel** control to compensate electronically for such distortions.

You can also use this menu to make simple panoramic screen corrections without using external processors.

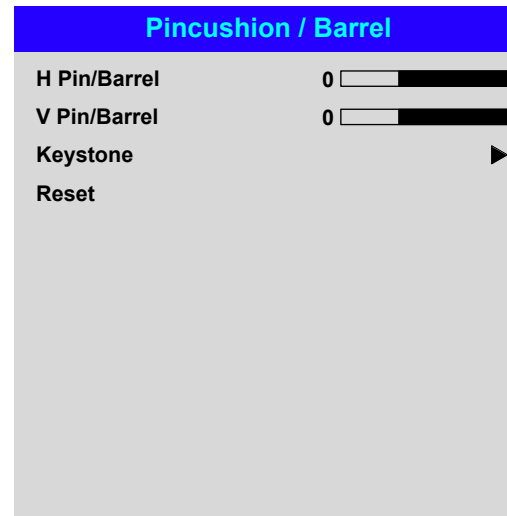

Notes

Pincushion / Barrel example

The illustration shows pincushion and barrel correction applied both horizontally and vertically, in equal measures.



Pincushion



Barrel

Geometry menu continued from previous page

Arc

This feature is similar to **Pincushion / Barrel** but allows you to apply curvature to each edge of the image independently so you can have any combination of corrections.



Arc	
Top	0 <input type="range"/>
Bottom	0 <input type="range"/>
Left	0 <input type="range"/>
Right	0 <input type="range"/>
Reset	

Notes

Please note that a positive **Arc** value on any edge will reduce the image size as the projector needs to maintain the aspect ratio.

A negative **Arc** value will not affect the overall image size.

Custom warp maps may be created using the Digital Projection - **Projector Controller PC** application.

The **Projector Controller** software is available for download from the Digital Projection website, free of charge.

Custom Warp

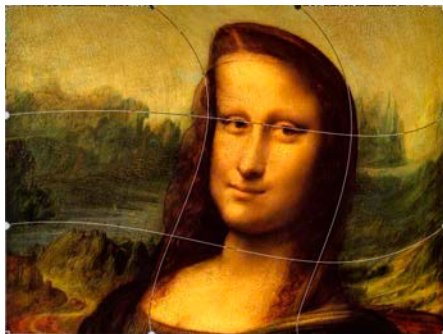

Geometry	
Aspect Ratio	Source
Digital Zoom & Shift	▶
Overscan	Off
Blanking	▶
Keystone	▶
4 Corners	▶
Rotation	▶
Pincushion / Barrel	▶
Custom Warp	<div style="border: 1px solid black; padding: 2px;"> Off User 1 User 2 </div>

Settings User 1 and User 2 are selections of user created predownloaded custom warp maps.

Edge Blend menu

Use this menu to blend together images from an array of two or more projectors.

The feature feathers the light output of the projector within the edges that overlap with other projectors in the array: as a result, the overlapping edges are evenly lit and easily blend in with the rest of the image.

- **Edge Blend**
Enable and disable **Edge Blend**
- **Align Pattern**
Add markers to the image showing the edges of the blend area and making the overlaps more visible to help adjust the physical position of the projectors in the array.
- **Blend Width**
Determine the width of the blended regions.
- **Black Level Uplift**
Adjust black levels to compensate if the blended regions appear brighter than the rest of the image.
- **Reset**
Reset all **Edge Blend** settings to their factory default values.



Notes

 When **Edge Blend** is set to **Off**, all other edge blend settings are disabled.

 The picture in the blend region needs to be delivered to all overlapping projectors, which may require a special setup of the source.

Edge Blend menu continued from previous page

Blend Width

Use the **LEFT** ◀ and **RIGHT** ▶ arrow buttons to set the width of the blended regions:

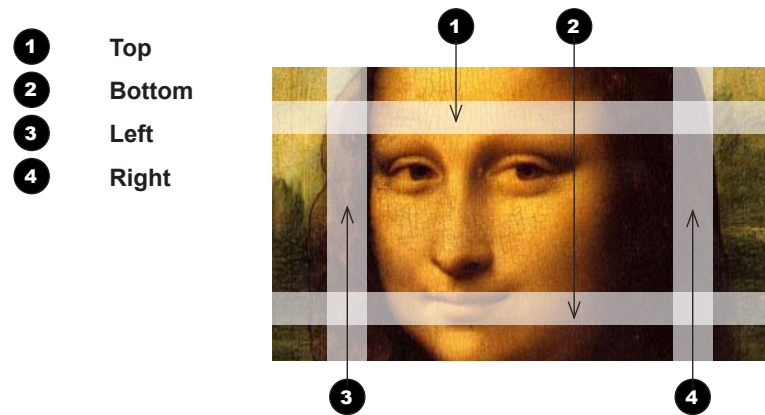

Blend Width	
Top	0 [Progress bar]
Bottom	0 [Progress bar]
Left	0 [Progress bar]
Right	0 [Progress bar]

Notes

Edge Blend menu continued from previous page

Black Level Uplift

Black in the blended regions appears less dark than in the rest of the image. To compensate for this, use this menu to raise the black levels of the rest of the image:

- Set **All** to the required amount of black level correction. This will apply equal correction to the black levels of all colors.
- If necessary, use the individual color sliders (**Red**, **Green** and **Blue**) for fine adjustment.

You may experience artifacts at the edges where the blended region of one projector overlaps the *pond of mirrors* of its neighbor. In the example below, the blended image comes from *two projectors*, **1** and **2**. Both images have black level uplift applied; as a result, *artifacts* **3** and **4** have emerged at the edges where the black level uplift region of one projector overlaps the pond of mirrors of the other.

To remove the artifacts, you need to slightly reduce the size of the black level uplift region of each projector so it does not overlap the pond of mirrors of the other projector.

- Depending on your array, use **Top**, **Bottom**, **Left** and/or **Right** to reduce the black level uplift size. In the example below, use the **Right** slider of the *projector on the left* **1** to remove the *artifact on the right* **4**, and the **Left** slider of the *projector on the right* **2** to remove the *artifact on the left* **3**.

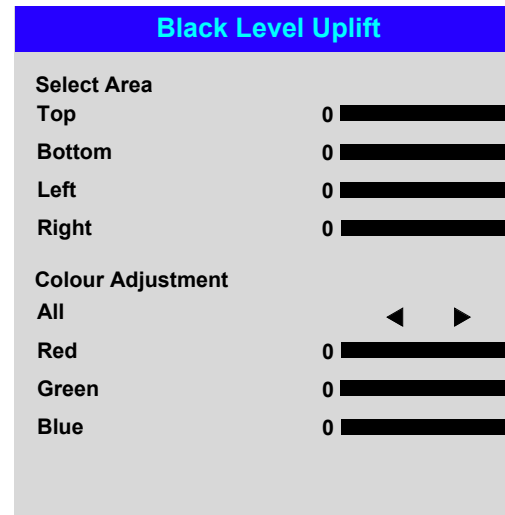

 Enable **Align Pattern** from the **Edge Blend** menu to see the black level uplift area.

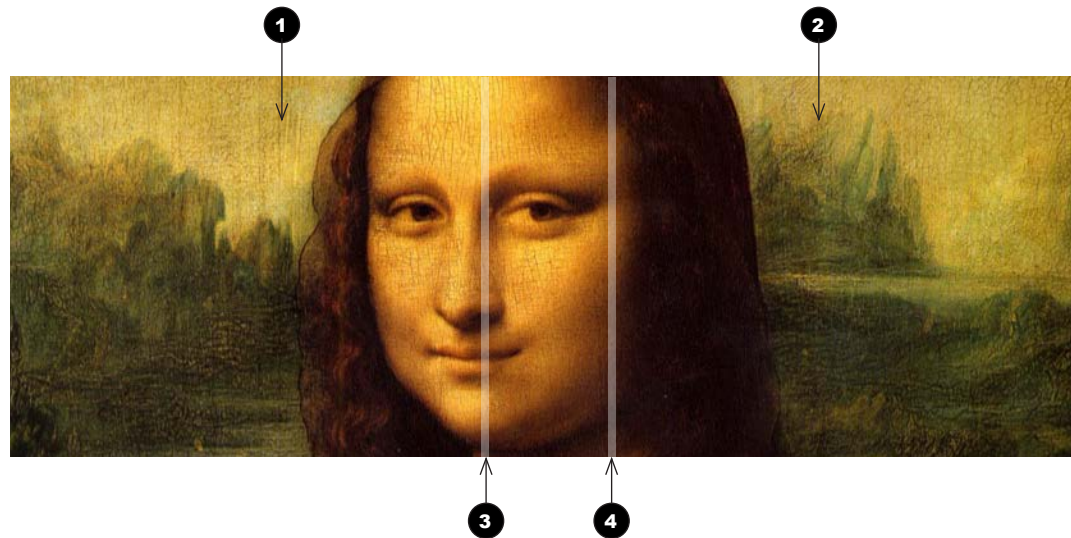

3D menu

Use this menu to enable, disable and set up 3D input, as follows:

- **3D Format** — **Off**, **Auto**, **Side-bySide (half)**, **Top and Bottom**, **Dual Pipe** and **Frame Sequential**.
Frame Sequential is displayed at the incoming rate whereas **Dual Pipe** is for sources where Left and Right eye are delivered on separate inputs.
- **DLP Link** — **Off** / **On**.
DLP Link On emits a sync pulse for the 3D glasses via the projected image. **DLP Link Off** will send the sync pulse to the sync out connector to use with an external third party emitter.
- **Eye Swap** — **Normal** and **Reverse** (set to **Reverse** if the left- and right-eye images are displayed in the wrong order)
- **Dark Time** — **0.65 ms**, **1.3 ms** and **1.95 ms**. Set to reduce the effect of banding and image overlapping when viewed through 3D the glasses.

3D Sync

- **Offset** — use the **LEFT** ◀ and **RIGHT** ▶ arrow buttons to compensate for image overlapping (ghosting) when viewed through 3D glasses.
- **Reference** — **External** and **Internal**. This is information only.

3D	
3D Format	Auto
DLP Link	Off
Eye Swap	Normal
Dark Time	1.95 ms
3D Sync	
Offset	100
Reference	Internal

Notes

If **3D Format** is set to **Off**, all other 3D settings will be unavailable.

For further information about supported 3D formats, see [3D connections](#) in the **Connection Guide**.

When 3D is on, the following settings become unavailable:

- **Image > Picture Mode, Dynamic Black, Freeze.**
- **Geometry > Digital Zoom, Overscan.**
- **PIP > all settings.**

See also [3D types](#) and [Some 3D settings explained](#) further in this guide.

See [Appendix B: Supported Signal Input Modes > 3D formats](#) in the **Reference Guide** for 3D resolutions and frame rates.

3D menu continued from previous page

3D types

In most situations you can use the **Auto** setting to have the projector automatically detect the format. Otherwise, consider the notes below to help you set up the 3D input manually.

The following 3D formats are supported:

- **Dual Pipe (LEFT and RIGHT)**

The left and right eye images are delivered on two separate HDMI links, which the projector will interleave for 3D display.

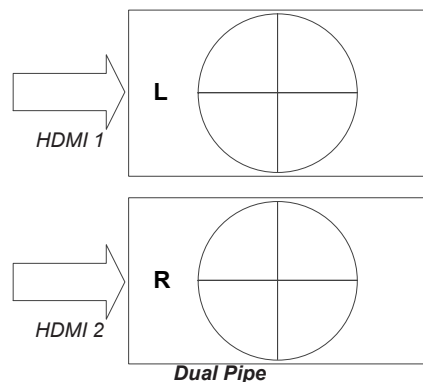

- **Frame Sequential**

Displayport and HDMI inputs can accept **Frame Sequential** formats where both left and right eye images are delivered on a single cable. Up to 120Hz can be received and displayed. Frames rates of 50Hz or 60Hz will be displayed at 100Hz or 120Hz respectively.

For sequential 3D, an external sync is required to identify left and right frames. If no sync is available from the sequential source, the projector will generate an output sync, but it may then be necessary to manually reset the dominance each time the player is started.

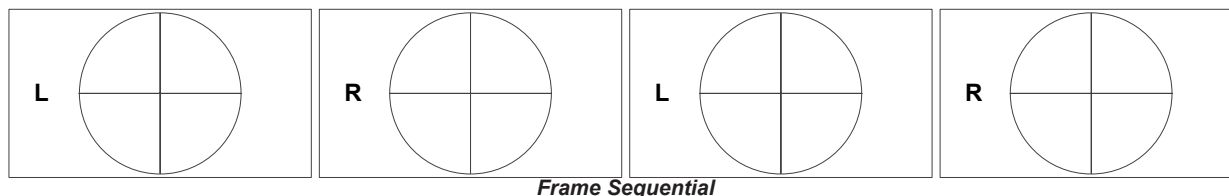

Notes

 Processing through the projector is limited 60Hz. Therefore while 120Hz sequential or Dual Pipe can be accepted and displayed it will drop to 60Hz for processing and then frame double after processing.

3D menu continued from previous page

- **Frame Packing**

This format will be detected, re-synchronised, frame-multiplied and displayed at 96 Hz with the left eye / right eye dominance automatically extracted from the video data. You need to optimize **Dark Time** and **Sync Delay** manually to suit your chosen switching glasses.

- **Top and Bottom**

Sets the projector to reformat the video frames and map them to the display with the left eye / right eye dominance automatically extracted from the video data. You need to optimize **Dark Time** and **Sync Delay** manually to suit your chosen switching glasses.

- **Side by Side (Half):** interlaced and progressive, 50 and 60Hz

The side-by-side image will be de-interlaced (if appropriate), resized and then sequentially displayed at 100 or 120 Hz. The left eye / right eye dominance will be automatically extracted from the video data, however you will need to optimize **Dark Time** and **Sync Delay** manually to suit your chosen switching glasses.

Dark Time and **Sync Delay** need to be set only once, to optimize the image for the glasses in use.

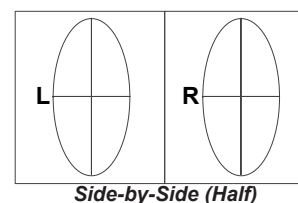
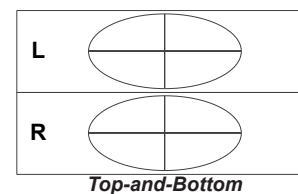
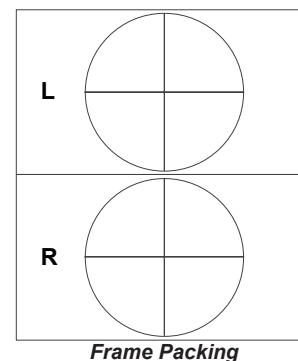
**Notes**

3D menu continued from previous page

Some 3D settings explained

Dark Time

Banding can be caused if the image is displayed before each eye of the 3D switching glasses or ZScreen is not fully open. **Dark Time** allows you to minimize this effect.

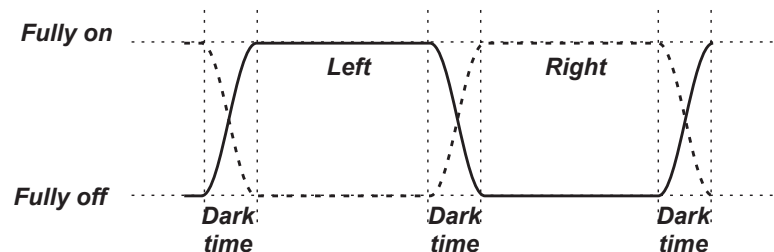

Eye Swap

The outgoing 3D frames are in pairs - the dominant frame being presented first. You can determine which frame should be the dominant one.

By convention the default setting is **Left**.

Dominance Left

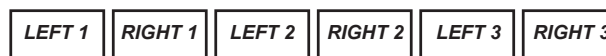

Dominance Right

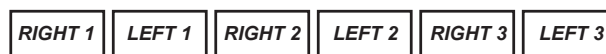

Sync Offset

The sync signal from the 3D server will be in phase with the frames generated by its graphics card. However, to compensate for switching delays in the glasses or ZScreen, **Sync Offset** is used to adjust the sync output signal sent to the ZScreen or 3D glasses to minimise overlapping (ghosting in the image when viewed through the 3D glasses)

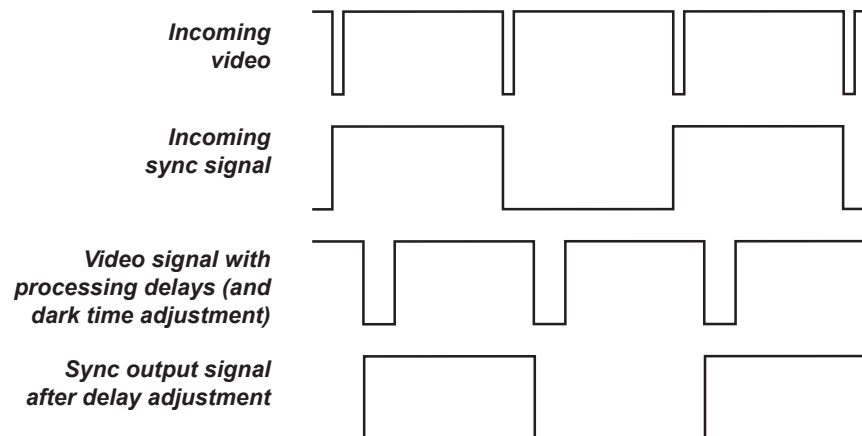

Notes



In order to achieve maximum light output and a smooth grayscale, whilst eliminating ghosting, the following procedure is recommended:

1. Set **Dark Time** to a value appropriate to the glasses or ZScreen, say 1.3 ms or 1.95 ms.
2. Adjust **Sync Offset** time to eliminate ghosting and achieve a smooth grayscale.
3. Repeat steps 1 and 2 until the best result is obtained.

Laser menu

- **Power Mode**

- **Eco** will automatically set the laser power to 80%.
- **Normal** will set the power to 100%.
- Set to **Custom** if you wish to adjust the power manually.

- **Power Level**

This setting is only available if **Power Mode** is set to **Custom**.

Choose a value between 20 and 100, ranging from 20% to 100% laser power.

- **Constant Brightness**

Once a **Custom** brightness has been set, then **Constant Brightness** can be turned **ON**. This setting will maintain the brightness until the maximum laser power has been reached. The lower the power level the longer it will be maintained.

Laser	
Power Mode	Normal
Power Level	-----
Constant Brightness	Off

Notes

Setup menu

- Orientation**
 Choose from **Front Tabletop**, **Front Ceiling**, **Rear Tabletop**, **Rear Ceiling** and **Auto-front**.
- High Altitude**
 Choose from **On**, **Auto** and **Quiet**.
- Standby Mode**
 Choose from **SuperECO**, **ECO** and **Normal**.
SuperECO uses minimal power and disables power ON via LAN.
ECO uses a low power setting but enables power ON via Ethernet port only.
Normal enables power ON via both HDBase-T/LAN and Ethernet ports.
- Screen Setting**
 Choose from **16:10**, **16:9** and **4:3**.
- ColorMax Setting**
 Set up user-defined color gamut values.
- Power On/Off**
 Access the submenu to set up automatic projector power on and power off.
- Clock Adjust**
 Access the submenu to set current date and local time.
- Startup Logo**
 Set this to **On** if you want the DP logo to show when the projector is first switched on.
- Blank Screen**
 Choose from **Logo**, **Black**, **Blue** and **White**.
- Auto Source**
 If this setting is **On**, the projector will automatically search for an active input source.
- OSD Settings**
 Access this submenu to adjust the appearance and position of the on-screen display.

Setup	
Orientation	Auto-front
High Altitude	Auto
Standby Mode	SuperECO
Screen Setting	16:9
ColorMax Setting	▶
Power On/Off	▶
Clock Adjust	▶
Startup Logo	On
Blank Screen	Logo
Auto Source	Off
OSD Settings	▶
▼	

Notes



Auto-front automatically detects the projector's position and sets the orientation accordingly.

Highlight the **DOWN ▼** arrow at the bottom of the page and press **ENTER/OK** to navigate to the second **Setup** menu page.

Setup menu continued from previous page

- **Trigger1 and Trigger 2**
Choose from **Screen, 5:4, 4:3, 16:10, 16:9, 1.88, 2.35, TheaterScope, Source, Unscaled** or **RS232** to determine what will cause each trigger output to activate.
- **Infrared Remote**
Set to **Off** if you wish to disable the remote control.
- **IR Code**
The projector and the remote control need a matching IR code: a two-digit number between **00** and **99**.

The default IR code is **00**. This is also a master code, which, if assigned to a remote, will work regardless of the value assigned to the projector.
To assign an IR code for the projector:
 1. Select **IR Code**.
 2. Use the **UP ▲** and **DOWN ▼** arrow buttons to change the values.**To assign an IR code for the remote:**
 1. Press and hold the **ADDR** button on the remote until the indicator starts flashing.
 2. Release the **ADDR** button and while the indicator is still flashing, enter a two-digit address using the numeric input buttons. The indicator will flash three times quickly to confirm the change.
- **IR Code Reset**
Use this command to unassign an IR code from the projector. This will revert the **IR Code** value to **00**.

To unassign an IR code from the remote control,
 - Press and hold **ALT** and **ADDR** simultaneously until the indicator flashes to confirm the change.
- **Memory**
Access this submenu to save up to four presets containing custom combinations of image settings, or to recall a saved preset.
- **Image Latency**
Choose either **Normal** or **Fast**.
Fast offers reduced latency for both 2D and 3D sources. **Normal** should be used in cases where large amounts of geometry or warp have been applied.

Highlight the **UP ▲** arrow at the top of the page and press **ENTER/OK** to go back to the first **Setup** menu page.

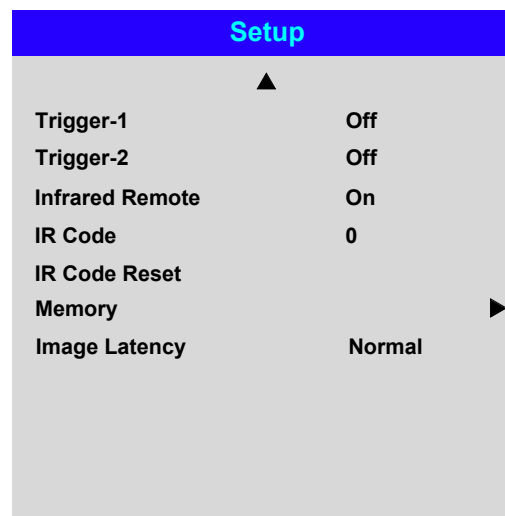
**Notes**

 If you turn the remote control off, you can only turn it back on again from the control panel or via the **Projector Controller** application.

The **Projector Controller** software is available for download from the [Digital Projection website](#), free of charge.

 A wired remote control will also be disabled if **Infrared Remote** is set to **Off**.

Setup menu continued from previous page

ColorMax Setting

ColorMax Setting permits seven point color matching of red, green, blue, yellow, cyan, magenta and white.

You can enter your own gamut values here, or edit values you have imported using the **Projector Controller** software.

Defining your own colorspace with individual x and y coordinates for each color enables you to match not only the whites but each individual color as well.

Highlight the submenu you wish to open and press **ENTER/OK** to confirm your choice.

Measured Data / Target Data

1. Use the **UP ▲** and **DOWN ▼** arrow buttons to highlight a color, then use the **LEFT ◀** and **RIGHT ▶** arrow buttons to navigate to the **x** or **y** coordinate.
2. Use the **UP ▲** and **DOWN ▼** arrow buttons to increase and decrease the value, respectively.
3. Exit edit mode:
 - press **ENTER/OK**, if you want to save the edited values.
 - press **EXIT**, if you do not wish to save the edited values
4. If necessary, highlight another color and repeat the procedure.

ColorMax	
Measured Data	▶
Target Data – User 1	▶
Target Data – User 2	▶

Measured Data		
Red	x: 0.658	y: 0.339
Green	x: 0.315	y: 0.662
Blue	x: 0.146	y: 0.043
White	x: 0.276	y: 0.283
Reset		

Target Data – User 1		
Red	x: 0.640	y: 0.390
Green	x: 0.300	y: 0.600
Blue	x: 0.150	y: 0.060
Yellow	x: 0.419	y: 0.505
Cyan	x: 0.225	y: 0.329
Magenta	x: 0.321	y: 0.154
White	x: 0.285	y: 0.302

Notes

 The **Projector Controller** software is available for download from the **Digital Projection** website, free of charge.

 This tool is best used in conjunction with a specialized light meter (a photo spectrometer) to measure color parameters within a particular installation. However, the preloaded generic factory default data set is designed to give more than satisfactory results.

Setup menu continued from previous page

Power On/Off

- **Auto Power Off**

Set this to On if you want the projector to go into STANDBY mode when no input source is detected for 20 minutes.

- **Auto Power On**

Set this to **On** if you want the projector to start up immediately when the mains is connected.

Set this to **Off** if you want the projector to go into STANDBY mode when the mains is connected. In this case, the projector will not start up until the **POWER** button is pressed on the control panel or the **ON** button is pressed on the remote control.

- **Scheduled on/off**

Access this submenu to create a weekly schedule for automatic on and off times:

1. Set a schedule:

- Use the **UP ▲** and **DOWN ▼** arrow buttons to highlight a row, then press **ENTER/OK** to enable edit mode.
- Within a row, navigate with the **LEFT ◀** and **RIGHT ▶** arrow buttons. Set values with the **UP ▲** and **DOWN ▼** arrow buttons.
- To exit edit mode, press **ENTER/OK**. Alternatively, press **EXIT** if you don't want the changes to take effect. Move to another row using the **UP ▲** and **DOWN ▼** arrow buttons.

2. To enable the schedule, set **Schedule** to **On**.

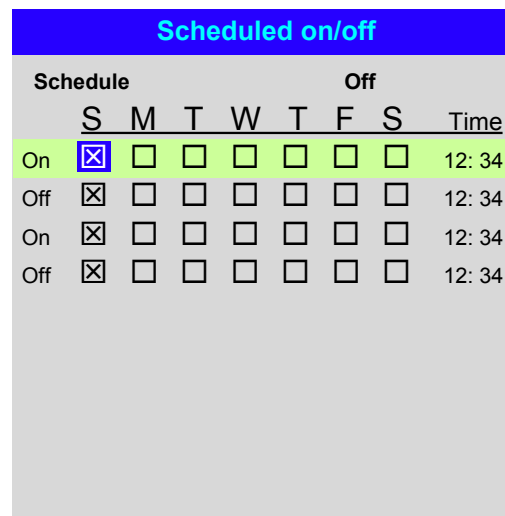
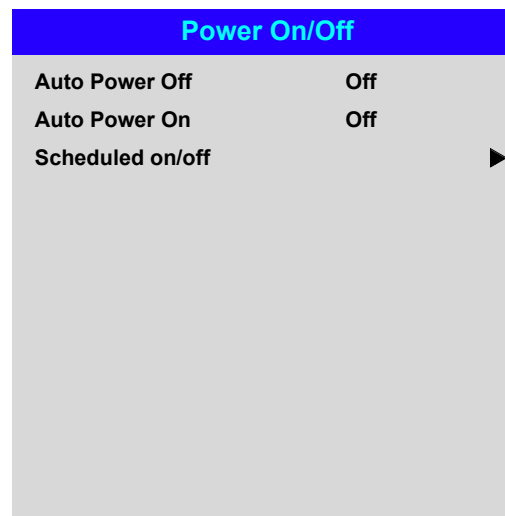

Notes

Setup menu continued from previous page

Clock Adjust

Use this menu to set date (in **dd:MM:yyyy** format), time (in **HH:mm** format) and time zone.

The date and time set here will affect any schedule created within the **Power On/Off** menu.



Notes

Setup menu continued from previous page

OSD Settings

- **Language** sets the OSD language.
- **Menu Position** determines where the OSD should appear on the screen when activated.
- **Menu Transparency** sets OSD transparency between **0%** (no transparency), **25%**, **50%** and **75%**.
- **Time Out** determines how long the OSD should remain on screen if no buttons are pressed. Choose **Always On** to disable this feature.
- **Message Box** determines whether projector status messages should appear on the screen.

Memory

The current image settings can be saved as a preset, which you can recall later. The default settings can be recalled at any time as well.

Up to four custom presets can be stored for each input.

The following settings are saved in a preset:

- From the **Image** menu — **Dynamic Black, Gamma, Brightness, Contrast, Saturation, Hue, Sharpness** and **Noise Reduction**
- From the **Color** menu — **Color Space, Color Mode, ColorMax, Color Temperature, RGB Lift** and **RGB Gain**
- From the **Geometry** menu — **Aspect Ratio** and **Overscan**
- From the **3D** Menu — **3D Format, DLPLink, Sync, Dark Time, Sync Offset**

To recall a saved preset:

- Select **Recall Memory** and press **ENTER/OK**, then select a preset from **Preset A** to **Preset D**. Select **Default** to load factory default values.

To save a preset:

- Select **Save Settings** and press **ENTER/OK**, then choose from **Preset A, Preset B, Preset C** and **Preset D**.

OSD Settings	
Language	English
Menu Position	Center
Menu Transparency	0
Time Out	30 Seconds
Message Box	On

Memory	
Recall Memory	Default
Save Settings	Preset A

Notes



Presets from one input cannot be applied to another input.

Network menu

- **Network Mode**
Choose between **Projector Control** and **Service**.
- **DHCP, IP, Subnet Mask, Gateway, DNS**
Set **DHCP** to **On** if the IP address is to be assigned by a DHCP server, or **Off** if it is to be set here.
If **DHCP** is **On**, it will not be possible to edit **IP Address, Subnet Mask, Gateway** or **DNS**.
If **DHCP** is set to **Off**, edit **IP Address, Subnet Mask, Gateway** and **DNS** as required.
- **MAC**
This field is read-only.
- **AMX (Device Discovery)**
Switch on or off.

Network	
Network Mode	Projector Control
DHCP	Off
IP	192 . 168 . 000 . 100
Subnet Mask	255 . 255 . 255 . 000
Gateway	000 . 000 . 000 . 000
DNS	000 . 000 . 000 . 000
MAC	00: 18: 27: 2d: f2: 06
AMX (Device Discovery)	On

Notes

PIP menu

- **PIP**
Turn PIP on and off.
- **Source**
Select an input source for the PIP image.
Any combinations are possible between main and PIP input source, as long as one of the inputs is either **DisplayPort** or **3G-SDI**.
- **Position**
Set the location of the PIP image on the screen. Choose from **Top-Left**, **Top-Right**, **Bottom-Left**, **Bottom-Right** and **PBP**.

PIP	
PIP	Off
Source	HDMI1
Position	Top-Left

Notes

Information menu

This menu gives information about software and hardware configuration, input source and laser operating times. It also allows you to restore the factory default settings.

Information	
Model Name	E-Vision Laser 4K
Serial Number	X000XXXXX0000
Software Version 1	MD02-SE07-FD01
Software Version 2	LE02-19-RD02-3092
Laser Hours	2
Active / PIP Source	HDMI 1
Signal Format	▶
System Status	▶
Thermal Status	▶
Factory Reset	

Notes

Signal Format

Signal Format	
Active Source	
Timing	1080p/60Hz
H Refresh	67.500 KHz
V Refresh	60.00 Hz
Pixel Clock	148.500 MHz
PIP Source	
Timing	576p/50Hz
H Refresh	31.250 KHz
V Refresh	50.00 Hz
Pixel Clock	27.0 MHz

Information menu continued from previous page

System Status

System Status	
Atmospheric Pressure	98988 Pa (116 m)
AC Voltage	160V – 264V
Ceiling Mode	0
Tilt Angle	4 deg
Portrait Angle	0 deg
Altitude Mode	Low
Laser Power	100%
Constant Brightness	Off

Thermal Status

Thermal Status	
Inlet Temp.	Ti=24 / Ta=34 °C
DMD Temp.	Tc=38 °C
LD 1-2 Temp.	B9=56 / B15=52 °C
Fan 1-4 Speed	1399 / 1402 / 1391 / 1686
Fan 5-8 Speed	1410 / 1200 / 1205 / 1686
Fan 9-12 Speed	1211 / 1407 / 1410 / 1691
Fan 13-16 Speed	1709 / 3005 / 3007 / 2495
Fan 17-20 Speed	2986 / 2984 / 2984 / 4493
Fan 21-23 Speed	3020 / 3015 / 2517
Water Pump Speed	3506 / 3026

Notes

Information menu continued from previous page

Factory Reset

To restore the factory default settings:

1. Navigate to **Factory Reset** and press **ENTER/OK**.
2. When prompted, press **ENTER/OK** to confirm your choice, or press **EXIT** to cancel.

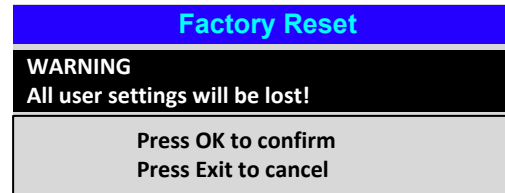

Notes



M-Vision Laser 18K Series

High Brightness Digital Video Projector

▶ REFERENCE GUIDE



IN THIS GUIDE

CHOOSING A LENS.....79

 Basic calculation.....80

 Basic calculation example81

 Full lens calculation.....82

 Introducing TRC.....82

 Calculating TRC.....83

 Calculating the throw ratio with TRC.....84

 Full lens calculation example85

POSITIONING THE IMAGE.....86

APPENDIX A: LENS PART NUMBERS88

APPENDIX B: SUPPORTED SIGNAL INPUT MODES89

 2D formats89

 3D formats92

APPENDIX C: WIRING DETAILS94

 RS23294

 Trigger 1 & Trigger 295

 Wired remote control95

 Sync IN and Sync OUT95

APPENDIX D: GLOSSARY OF TERMS96

Choosing A Lens

A number of lenses are available. Which lens you choose depends on the screen size, image aspect ratio, throw distance and light output.

The following table shows all available lenses in order of their **throw ratios**:

Throw ratios	Focus range	Lens shift
1.20 - 1.56 : 1 zoom	1 m - 8 m	V: 0.5 (U) 0.5 (D) frame H: 0.15 (L) 0.15 (R) frame
1.50 - 2.00 : 1 zoom	2 m - 12 m	V: 0.5 (U) 0.3 (D) frame H: 0.15 (L) 0.15 (R) frame
2.00 - 4.00 : 1 zoom	2.5 m - 15 m	V: 0.5 (U) 0.3 (D) frame H: 0.15 (L) 0.15 (R) frame
4.00 - 7.00 : 1 zoom	4 m - 42 m	V: 0.5 (U) 0.3 (D) frame H: 0.15 (L) 0.15 (R) frame

To choose a lens, calculate the **throw ratio** required.

Notes

 Throw distance calculations are based on the distance from the outer end of the lens, which will vary from lens to lens.

The distance between the front of the projector chassis and the outer end of the lens is called **lens extension**. Lens extensions is measured when the lens is focused at infinity, and fully extended.

 Refer to the projector CAD drawings for individual lens extension figures.

 For information about individual lens part numbers, see [Appendix A](#) at the end of this document.

Basic calculation

Identify the required lens by calculating the **throw ratio**.

A **throw ratio** is the ratio of the throw distance to the screen width:

$$\text{Throw ratio} = \frac{\text{Throw distance}}{\text{Screen width}}$$

1. Use the formula above to obtain the required throw ratio.
2. Match the throw ratio with a lens from the table below:

Throw ratios	Focus range
1.20 - 1.56 : 1 zoom	1 m - 8 m
1.50 - 2.00 : 1 zoom	2 m - 12 m
2.00 - 4.00 : 1 zoom	2.5 m - 15 m
4.00 - 7.00 : 1 zoom	4 m - 42 m

3. Ensure the required throw distance is within the range covered by the lens.

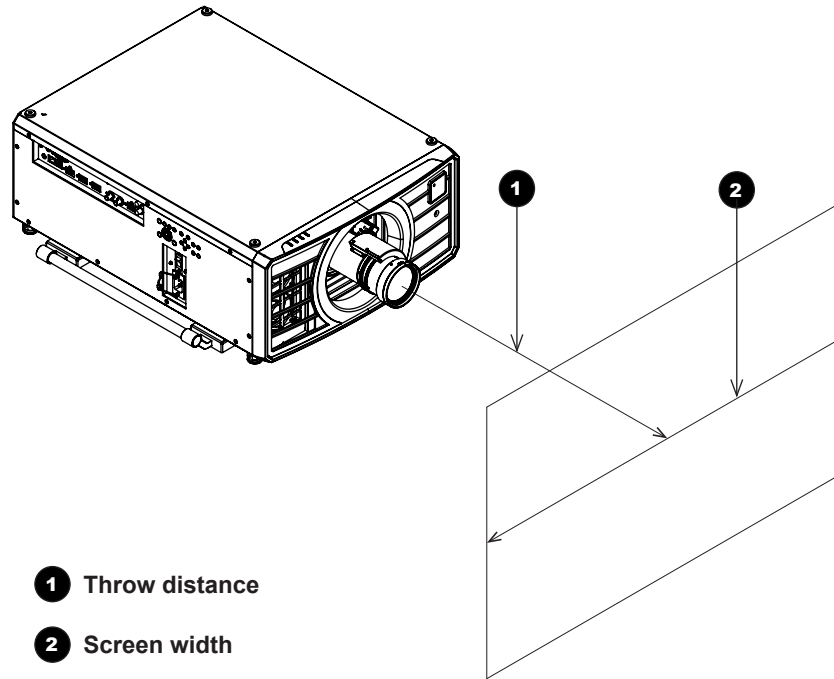

1 Throw distance

2 Screen width

Notes

The lens table shown on this page includes High Brightness lenses only. For a full list, see [Appendix A](#) at the end of this document.

The basic calculation on this page does not take into consideration DMD™ and image size, which could affect the throw ratio. For a more complex and realistic calculation, see [Full lens calculation](#) in this section.

When calculating the throw ratio, be sure to use identical measurement units for both the throw distance and the screen width.

For information about individual lens part numbers, see [Appendix A](#) at the end of this document.

Basic calculation example

1. Calculate the throw ratio using the formula.

Your screen is **4.5 m** wide and you wish to place the projector approximately **10 m** from the screen. The throw ratio will then be

$$\frac{10}{4.5} = 2.22$$

2. Match the result with the lens table.

The lens matching a throw ratio of 2.22 is **the 2.00 - 4.00 : 1 zoom lens**.

3. Check whether the lens covers the required throw distance.

The focus range quoted for the 2.00 - 4.00 : 1 zoom lens is **2.5 - 15 m**. The required distance of 10 m is within the range.

INFORMATION YOU NEED FOR THIS CALCULATION

- The throw ratio formula:

$$\text{Throw ratio} = \frac{\text{Throw distance}}{\text{Screen width}}$$

- The lens table:

Throw ratios	Focus range
1.20 - 1.56 : 1 zoom	1 m - 8 m
1.50 - 2.00 : 1 zoom	2 m - 12 m
2.00 - 4.00 : 1 zoom	2.5 m - 15 m
4.00 - 7.00 : 1 zoom	4 m - 42 m

Notes



The lens table shown on this page includes High Brightness lenses only. For a full list, see [Appendix A](#) at the end of this document.



The basic calculation on this page does not take into consideration DMD™ and image size, which could affect the throw ratio. For a more complex and realistic calculation, see [Full lens calculation](#) in this section.



For information about individual lens part numbers, see [Appendix A](#) at the end of this document.

Full lens calculation

Introducing TRC

The choice of lens will affect the image size and will address discrepancies between the DMD™ resolution and the source.

When an image fills the height of the DMD™ but not the width, it uses less than 100% of the DMD™ surface. A lens chosen using the basic formula may produce an image that is considerably smaller than the actual screen.

To compensate for loss of screen space in such situations, you need to increase the throw ratio using a **Throw Ratio Correction (TRC)**.

Example

Fig. 1 illustrates a 4:3 image within a WUXGA DMD™.

When a WUXGA projector is used for a 4:3 image, the image does not fill the width of the DMD™, creating a **pillarboxing** effect - blank spaces to the left and right.

Fig. 2 shows the same image projected on a 4:3 screen using a standard lens (chosen with the basic calculation).

The DMD™ accurately fills the width of the screen; however, the pillarboxing is now part of the projected image and is transferred to the screen.

The DMD™ does not fill the height of the screen, which has caused **letterboxing** - further blank spaces at the top and bottom of the screen.

The image is now surrounded by blank space, which can be removed if the throw ratio is increased.

Fig. 3 shows the image projected on the same screen with a lens chosen using TRC.

The increased throw ratio has allowed the 4:3 image to fill the 4:3 screen seamlessly.



Fig. 1

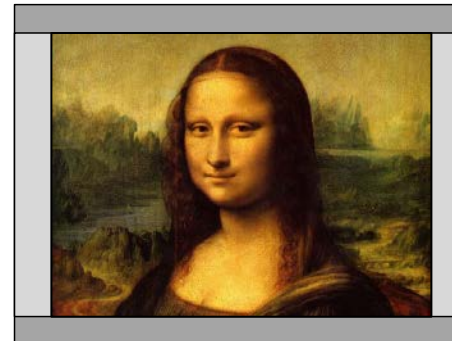



Fig. 2



Fig. 3

Notes

 TRC can only be applied if greater than 1. If TRC is 1 or less, disregard it and calculate the throw ratio using the basic formula.

Calculating TRC

To calculate TRC, use the following formula:

$$TRC = \frac{1.6 \text{ (DMD™ aspect ratio)}}{\text{Source aspect ratio}}$$

TRC table

Alternatively, you can save time by referencing the following table, which shows the TRC value for some popular image formats:

2.35:1 (Scope) , 1920 x 817 pixels	TRC < 1, not used
1.85:1 (Flat) , 1920 x 1037 pixels	TRC < 1, not used
1.78:1 (16:9) , 1920 x 1080	TRC < 1, not used
1.66:1 (Vista) , 1792 x 1080 pixels	TRC < 1, not used
1.6:1 (16:10) , 1728 x 1080 pixels	TRC = 1, not used (native resolution)
1.33:1 (4:3) , 1440 x 1080 pixels	TRC = 1.2
1.25:1 (5:4) , 1350 x 1080 pixels	TRC = 1.28

Notes

TRC can only be applied if greater than 1. If TRC is 1 or less, disregard it and calculate the throw ratio using the basic formula.

Calculating the throw ratio with TRC

1. For TRC > 1, amend the basic throw ratio formula as follows:

$$\text{Throw ratio} = \frac{\text{Throw distance}}{\text{Screen width} \times \text{TRC}}$$

2. Once a throw ratio is established, identify the matching lens from the table:

Throw ratios	Focus range
1.20 - 1.56 : 1 zoom	1 m - 8 m
1.50 - 2.00 : 1 zoom	2 m - 12 m
2.00 - 4.00 : 1 zoom	2.5 m - 15 m
4.00 - 7.00 : 1 zoom	4 m - 42 m

3. Ensure the required throw distance is within the range of the matching lens.

Notes



The lens table shown on this page includes High Brightness lenses only. For a full list, see [Appendix A](#) at the end of this document.



TRC can only be applied if greater than 1. If TRC is 1 or less, disregard it and calculate the throw ratio using the basic formula.

Full lens calculation example

Your screen is **4.5 m** wide; you wish to place the projector approximately **10 m** from the screen. The source is **4:3**.

1. Calculate TRC as follows:

$$TRC = \frac{1.6}{1.33} = 1.2$$

2. Calculate the throw ratio:

$$Throw\ ratio = \frac{10}{4.5 \times 1.2} = 1.85$$

3. Find a match in the lens table.
 The table shows that the matching lens is **the 1.50 - 2.00 : 1 zoom lens**.

4. Check whether the lens covers the required throw distance.
 The focus range quoted for the 1.50 - 2.00 : 1 zoom lens is **2 - 12 m**. The required distance of 10 m is within the range.

INFORMATION YOU NEED FOR THESE CALCULATIONS

- The TRC formula
$$TRC = \frac{DMD^{TM}\ aspect\ ratio}{Source\ aspect\ ratio}$$
- The TRC table (to use instead of the formula)

2.35:1 (Scope)	TRC not used
1.85:1 (Flat)	TRC not used
1.78:1 (16:9)	TRC not used
1.66:1 (Vista)	TRC not used
1.6:1 (16:10)	TRC not used (native resolution)
1.33:1 (4:3)	TRC = 1.2
1.25:1 (5:4)	TRC = 1.28

$$Throw\ ratio = \frac{Throw\ distance}{Screen\ width \times TRC}$$

- The throw ratio formula
- The lens table:

Throw ratios	Focus range
1.20 - 1.56 : 1 zoom	1 m - 8 m
1.50 - 2.00 : 1 zoom	2 m - 12 m
2.00 - 4.00 : 1 zoom	2.5 m - 15 m
4.00 - 7.00 : 1 zoom	4 m - 42 m

Notes

 The lens table shown on this page includes High Brightness lenses only. For a full list, see [Appendix A](#) at the end of this document.

Positioning The Image

The normal position for the projector is at the centre of the screen. However, you can set the projector above or below the centre, or to one side, and adjust the image using the **Lens shift** feature (known as *rising and falling front*) to maintain a geometrically correct image.

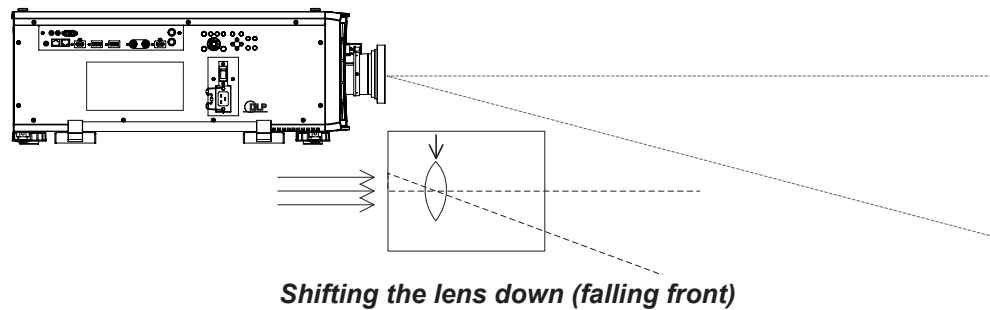
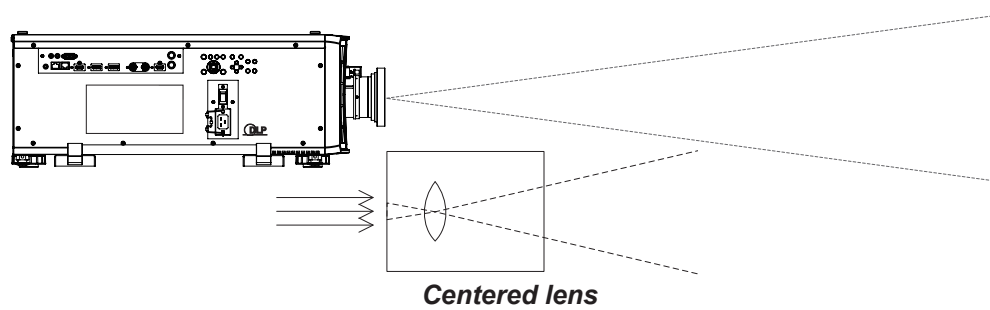
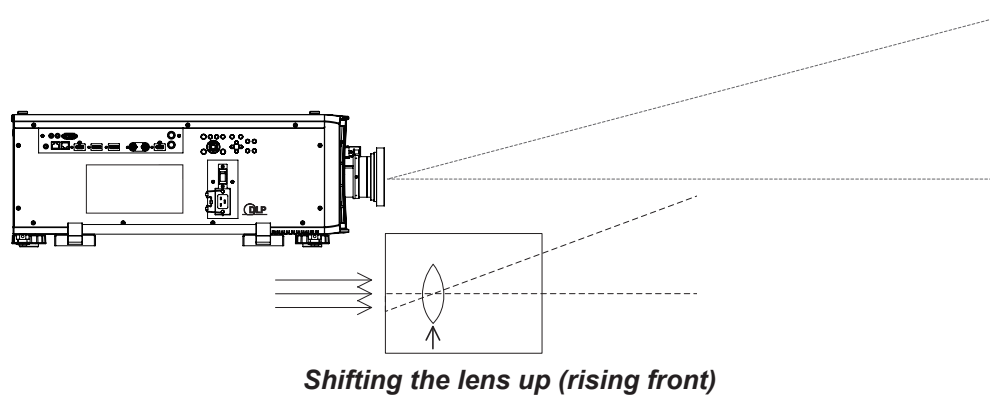

Notes

Any single adjustment outside the ranges specified on the following page may result in an unacceptable level of distortion, particularly at the corners of the image, due to the image passing through the periphery of the lens optics.

If the lens is to be shifted in two directions combined, the maximum range without distortion will be somewhat less, as can be seen in the illustrations below.

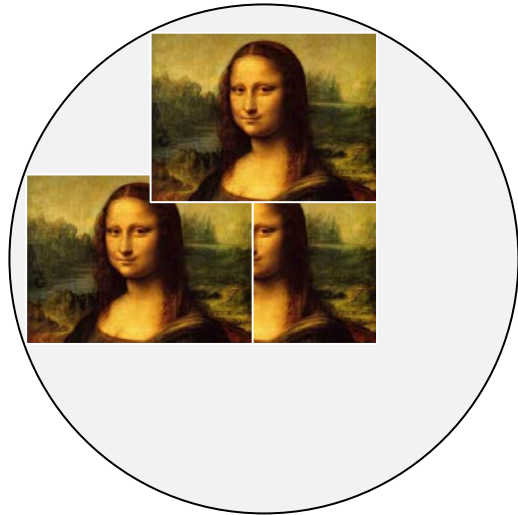

Full horizontal or vertical shift

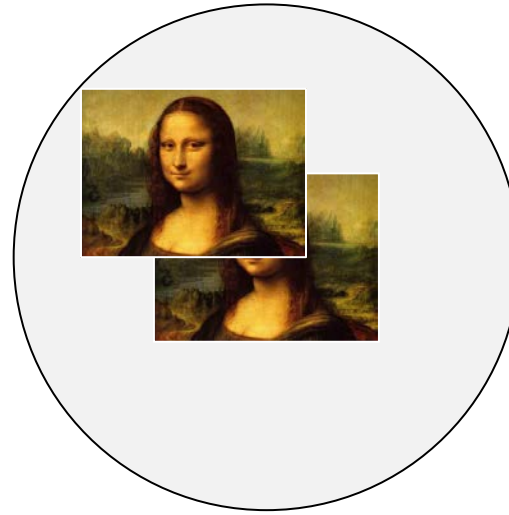

Combined shift is reduced

Notes

Appendix A: Lens Part Numbers

Throw ratios	Part number	Focus range	Lens shift
0.84-1.03:1	114-313	1.5m - 10m	V: 0.37 (U) 0.37 (D) frame H: 0.12 (L) 0.12 (R) frame
1.20 - 1.56 : 1 zoom	117-573	1 m - 8 m	V: 0.5 (U) 0.5 (D) frame H: 0.15 (L) 0.15 (R) frame
1.50 - 2.00 : 1 zoom	118-578	2 m - 12 m	V: 0.5 (U) 0.3 (D) frame H: 0.15 (L) 0.15 (R) frame
2.00 - 4.00 : 1 zoom	118-588	2.5 m - 15 m	V: 0.5 (U) 0.3 (D) frame H: 0.15 (L) 0.15 (R) frame
4.00 - 7.00 : 1 zoom	117-483	4 m - 42 m	V: 0.5 (U) 0.3 (D) frame H: 0.15 (L) 0.15 (R) frame

Notes

 Throw distance calculations are based on the distance from the outer end of the lens, which will vary from lens to lens.

The distance between the front of the projector chassis and the outer end of the lens is called **lens extension**. Lens extensions is measured when the lens is focused at infinity, and fully extended.

 Refer to the projector CAD drawings for individual lens extension figures.

 The **0.38 : 1 fixed lens** has no adjustable shift value. However, the lens has an inherent offset depending on image size. See the UST documentation published separately on the Digital Projection website.

 The **0.84 - 1.03 : 1 zoom lens** has an additional feature permitting focus correction for curved screens. The front ring of the lens is a manual control which provides focus curvature adjustment to correct for the different focal distances between center and corner.

Appendix B: Supported Signal Input Modes

2D formats

Signal Format	Resolution	H Freq. (KHz)	Frame Rate (Hz)	PCLK (MHz)	DisplayPort	HDMI / HDBaseT				HD/SDI/3G	Remark
						RGB	YUV 8-bit	YUV 10-bit	YUV 12-bit		
PC	640x480	31.469	59.94	25.175	X	X					VESA DMT
	640x480	37.500	74.99	31.500	X	X					VESA DMT
	640x480	43.269	85	36.000	X	X					VESA DMT
	800x600	37.879	60.32	40.000	X	X					VESA DMT
	800x600	46.875	75	49.500	X	X					VESA DMT
	800x600	53.674	85.06	56.250	X	X					VESA DMT
	848x480	23.674	47.95	25.000	X	X					VESA CVT
	848x480	31.020	60	33.750	X	X					VESA DMT
	1024x768	48.363	60	65.000	X	X					VESA DMT
	1024x768	56.476	70.07	75.000	X	X					VESA DMT
	1024x768	60.023	75	78.750	X	X					VESA DMT
	1024x768	68.677	85	94.500	X	X					VESA DMT
	1152x864	67.5	75	108.000							VESA DMT
	1280x720	35.531	47.95	57.987	X	X					VESA GTF
	1280 x 768	47.776	60	79.500	X	X					VESA DMT
	1280 x 768	60.289	74.89	102.250	X	X					VESA DMT
	1280 x 768	68.633	84.84	117.500	X	X					VESA DMT
	1280 x 800	49.702	60	83.500	X	X					VESA DMT
	1280 x 800	62.795	74.93	106.500	X	X					VESA DMT
	1280 x 960	60.000	60	108.000	X	X					VESA DMT
	1280 x 960	85.938	85	148.500	X	X					VESA DMT
1280x1024	63.981	60.02	108.000	X	X					VESA DMT	
1280x1024	79.976	75.02	135.000	X	X					VESA DMT	
1280x1024	91.146	85.02	157.500	X	X					VESA DMT	

Notes

Signal Format	Resolution	H Freq. (KHz)	Frame Rate (Hz)	PCLK (MHz)	DisplayPort	HDMI / HDBaseT				HD/SDI/3G	Remark
						RGB	YUV 8-bit	YUV 10-bit	YUV 12-bit		
PC continued	1366 x 768	47.712	60	85.500	X	X					VESA DMT
	1400X1050	65.317	60	121.750	X	X					VESA DMT
	1400X1050	82.278	74.87	156.000	X	X					VESA DMT
	1440 x 900	55.935	59.89	106.500	X	X					VESA DMT
	1440 x 900	70.635	74.98	136.750	X	X					VESA DMT
	1600x900	55.92	60	119.000	X	X					VESA GTF
	1600x1200	75.000	60	162.000	X	X					VESA DMT
	1680x1050	65.290	60	146.250	X	X					VESA DMT
	1920x1080	53.225	47.95	135.403	X	X					VESA CVT
	1920x1200 RB	61.816	50	158.250	X	X					VESA CVT
	1920x1200 RB	74.038	60	154.000	X	X					VESA CVT
	2048x1152 RB	72.000	60	162.000	X						VESA CVT
	2560x1600 RB	98.713	59.97	268.500	X						VESA CVT
Apple Mac	640x480		66.59		X	X					Apple MAC
	832x624		74.54		X	X					Apple MAC
	1024x768	60.241	74.93	80.000	X	X					Apple MAC
	1152x870	68.861	75.06	100.000	X	X					Apple MAC
SDTV	480i		59.94							X	
	1440x480i		60			X	X	X	X		
	1440x576i		50			X	X	X	X		
	576i		50							X	
EDTV	480p		59.94		X	X	X	X	X		
	576p		50		X	X	X	X	X		

Signal Format	Resolution	H Freq. (KHz)	Frame Rate (Hz)	PCLK (MHz)	DisplayPort	HDMI / HDBaseT				HD/SDI/3G	Remark
						RGB	YUV 8-bit	YUV 10-bit	YUV 12-bit		
HDTV	1035i		60			X	X	X	X	X	
	1080i		50		X	X	X	X	X	X	
	1080i		59.94		X	X	X	X	X	X	
	1080i		60		X	X	X	X	X	X	
	720p		50		X	X	X	X	X	X	
	720p		59.94		X	X	X	X	X	X	
	720p		60		X	X	X	X	X	X	
	1080p		23.98		X	X	X	X	X	X	
	1080p		24		X	X	X	X	X	X	
	1080p		25		X	X	X	X	X	X	
	1080p		29.97		X	X	X	X	X	x	
	1080p		30		X	X	X	X	X	X	
	1080p		50		X	X	X	X	X	X	
	1080p		59.94		X	X	X	X	X	X	
	1080p		60		X	X	X	X	X	X	
PsF formats	1080sf	27	24	74.250						X	
	1080sf	28.125	25	74.250						X	
	1080sf	33.75	30	74.250						X	
HD-SDI	720p24	18	24	74.250						X	
	720p25	18.75	25	74.250						X	
	720p30	22.5	30	74.250						X	

3D formats

Standard		Resolution	V-Freq (Hz)	V-Total	H-Freq (kHz)	HDMI1/2 (*1)	DisplayPort (*2)	HB Dual-pipe HDMI (*3)	HB DisplayPort (*3)	Remarks	Output Display Frame Rate
720p50	Frame Packing	1280x720	50.00	1470	37.50	√				*5	100
720p59	Frame Packing	1280x720	59.94	1470	44.96	√				*5	120
720p60	Frame Packing	1280x720	60.00	1470	45.00	√				*5	120
720p50	Top-and-Bottom	1280x720	50.00	750	37.50	√	√			*5	100
720p59	Top-and-Bottom	1280x720	59.94	750	44.96	√	√			*5	120
720p60	Top-and-Bottom	1280x720	60.00	750	45.00	√	√			*5	120
1080p23	Frame Packing	1920x1080	23.98	2205	26.97	√				*6	96
1080p24	Frame Packing	1920x1080	24.00	2205	27.00	√				*6	96
1080i50	Side-by-Side (Half)	1920x1080	50.00	1125	56.25	√	√			*5	100
1080i59	Side-by-Side (Half)	1920x1080	59.94	1125	67.43	√	√			*5	120
1080i60	Side-by-Side (Half)	1920x1080	60.00	1125	67.50	√	√			*5	120
1080p50	Side-by-Side (Half)	1920x1080	50.00	1125	56.25	√	√			*5	100
1080p59	Side-by-Side (Half)	1920x1080	59.94	1125	67.43	√	√			*5	120
1080p60	Side-by-Side (Half)	1920x1080	60.00	1125	67.50	√	√			*5	120
1080p50	Top-and-Bottom	1920x1080	50.00	1125	56.25	√	√			*5	100
1080p59	Top-and-Bottom	1920x1080	59.94	1125	67.43	√	√			*5	120
1080p60	Top-and-Bottom	1920x1080	60.00	1125	67.50	√	√			*5	100
1080p50	Frame Sequential	1920x1080	50.00	1125	56.25	√	√			*5	100
1080p59	Frame Sequential	1920x1080	59.94	1125	67.43	√	√			*5	120
1080p60	Frame Sequential	1920x1080	60.00	1125	67.50	√	√			*5	120
1080p100	Frame Sequential	1920x1080	100.00	1125	112.50		√		√	*4, *5	100
1080p120	Frame Sequential	1920x1080	120.00	1125	135.00		√		√	*4, *5	120
WUXGA_100_RB	Frame Sequential	1920x1200	100.00	1258	125.72		√		√	*4, *5	100
WUXGA_120_RB	Frame Sequential	1920x1200	120.00	1271	152.40		√		√	*4, *5	120
1080p23	Dual Pipe	1920x1080	23.98	1125	26.97			√		*6	96
1080p24	Dual Pipe	1920x1080	24.00	1125	27.00			√		*6	96

Notes



Remarks:

*1: Based on IT6802 chip specification

*2: Based on IT6535 chip specification

*3: Disable PIP function in this situation

*4: 8-bit / color

*5: Frame drop at scaler and frame doubling at formatter

*6: Output display frame rate up to 96Hz for 24Hz 3D input

Standard		Resolution	V-Freq (Hz)	V-Total	H-Freq (kHz)	HDMI1/2 (*1)	DisplayPort (*2)	HB Dual-pipe HDMI (*3)	HB DisplayPort (*3)	Remarks	Output Display Frame Rate
1080p25	Dual Pipe	1920x1080	25.00	1125	28.13			√		*5	100
1080p30	Dual Pipe	1920x1080	30.00	1125	33.75			√		*5	120
1080p50	Dual Pipe	1920x1080	50.00	1125	56.25			√		*5	100
1080p59	Dual Pipe	1920x1080	59.94	1125	67.43			√		*5	120
1080p60	Dual Pipe	1920x1080	60.00	1125	67.50			√		*5	120
WUXGA_60_RB	Dual Pipe	1920x1200	60.00	1235	74.04			√		*5	120

Appendix C: Wiring Details

RS232

9 way D-type connector

- 1 unused
- 2 Transmitted Data (TX)
- 3 Received Data (RX)
- 4 unused
- 5 Signal Ground
- 6 unused
- 7 unused
- 8 unused
- 9 unused

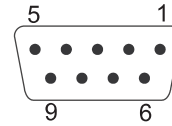

RS232:
pin view of female connector

Notes

Trigger 1 & Trigger 2

3.5 mm mini jack

Tip Trigger
Ring Not connected
Sleeve Ground

Output: 12V, 200 mA max

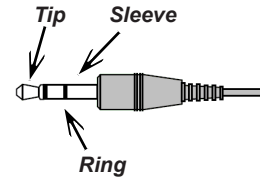

Wired remote control

3.5 mm mini jack

Tip 3V output
Ring Signal
Sleeve Ground

Output: 2.85-3.15V, Max. 500 mA

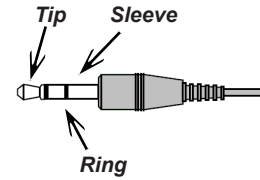

Sync IN and Sync OUT

75 ohm BNC

Max input / output voltage: 5.5V

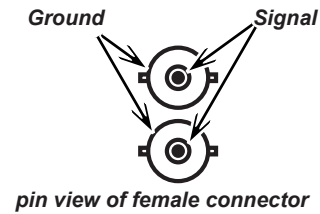

Notes

Appendix D: Glossary Of Terms

1080p

An [HDTV resolution](#) which corresponds to 1920 x 1080 [pixels](#) (a widescreen [aspect ratio](#) of 16:9).

3D active glasses

Wireless battery-powered glasses with LCD shutters. Synchronization information is communicated to the glasses by means of an infrared (IR) or radio frequency (RF) emitter which is connected to the Sync Out terminal on the projector. IR or RF pulses are transmitted by the emitter to signal when the left eye and right eye images are being displayed. The glasses incorporate a sensor which detects the emitter's signal and synchronises the left and right eye shutters with the projected image.

3D passive glasses

Passive glasses do not require a power source to work. Light with left-hand polarisation can pass through the left lens and light with right-hand polarisation can pass through the right-hand lens. These glasses are used in conjunction with another device which polarizes the image, such as a [ZScreen](#).

Adjust lines

A pattern applied to the image where its edge is to be blended with another image. Adjust lines are used to position the projectors in the array during the [edge blend](#) process.

Anamorphic lens

A special lens which, when used with the [TheaterScope aspect ratio](#), allows watching 2.35:1 content packed in a 16:9 source.

Aperture

The opening of the lens that determines the angle through which light travels to come into focus.

Notes

Aspect ratio

The proportional relationship between the width and the height of the projected image. It is represented by two numbers separated by a colon, indicating the ratio of image width and height respectively: for example, 16:9 or 2.35:1.

Not to be confused with [resolution](#).

Blanking (projection)

The ability to intentionally turn off, that is, set to black, areas around the edges of the projected image. It is sometimes referred to as “curtains” since it can be used to blank an area of image that literally falls on the curtains at the side of the screen in a movie theater. Usually no image resizing or geometric correction takes place and the “blanked” part of the image is lost.

Not to be confused with horizontal and vertical [blanking \(video signal\)](#).

Blanking (video signal)

The section of the video signal where there is no active video data.

Not to be confused with [blanking \(projection\)](#).

Blend region

The area of the image that is to overlap with another image in an [edge blend](#) setup. Sometimes called *overlapping region*.

Brightness (electronic control)

A control which adds a fixed intensity value to every [pixel](#) in the display, moving the entire range of displayed intensities up or down, and is used to set the black point in the image (see [Contrast](#)). In [Component Video](#) signals, brightness is the same as [luminance](#).

Brightness (optical)

Describes how ‘bright’ an image that is projected onto a screen appears to an observer.

C

See [Chrominance](#).

Notes

Chrominance

Also known as '**C**', this is the component, or pair of components, of a **Component Video** signal which describes **color difference** information.

Color difference

In **Component Video** signals, the difference between specified colors and the **luminance** component. Color difference is zero for monochrome images.

Color gamut

The spectrum of color available to be displayed.

Color temperature

The position along the black body curve on the chromaticity diagram, normally quoted in Kelvin. It takes into account the preset values for color balance in the service set-up to take up the variations in the prism. The projector allows you to adjust this temperature (i.e. adjust the picture color temperature).

Component video

A three-wire or four-wire video interface that carries the signal split into its basic **RGB** components or **luminance (brightness)** and two-**color-difference** signals (**YUV**) and **synchronization** signals.

Contrast (electronic control)

The adjustment of the white point of the image without affecting the black point. This increases the intensity range of the displayed image.

Contrast (optical)

The intensity difference between the darkest and lightest areas of the screen.

Cr, Cb

Color difference signals used with '**Y**' for digital **Component Video** inputs. They provide information about the signal color. Not to be confused with **Pr, Pb**.

Notes

Crop

Remove part of the projected image.

Alternatively, fit an image into a frame with a different **aspect ratio** by removing part of the image. The image is resized so that either its length or its width equals the length or width of the frame, while the other dimension has moved outside the frame; the excess area is then cut out.

Dark time

The time inserted between **frames** when using **3D active glasses**, to avoid **ghosting** caused by switching time between left and right eye.

DDC (Display Data Channel)

A communications link between the source and projector. DDC is used on the HDMI, DVI and VGA inputs. The link is used by the source to read the **EDID** stored in the projector.

Deinterlacing

The process of converting **interlaced** video signals into **progressive** ones.

DHCP (Dynamic Host Configuration Protocol)

A network protocol that is used to configure network devices so that they can communicate on an IP network, for example by allocating an IP address.

DMD™ (Digital Micromirror Device™)

The optical tool that transforms the electronic signal from the input source into an optical image projected on the screen. The DMD™ of a projector has a fixed **resolution**, which affects the **aspect ratio** of the projected image.

A Digital Micromirror Device™ (DMD™) consists of moving microscopic mirrors. Each mirror, which acts as a **pixel**, is suspended between two posts by a thin torsion hinge. It can be tilted to produce either a bright or dark pixel.

Edge blend

A method of creating a combined image by blending the adjoining edges of two or more individual images.

Notes**Remarks:**

*1: Based on IT6802 chip specification

*2: Based on IT6535 chip specification

*3: Disable PIP function in this situation

*4: 8-bit / color

*5: Frame drop at scaler and frame doubling at formatter

*6: Output display frame rate up to 96Hz for 24Hz 3D input

Edge tear

An artifact observed in [interlaced video](#) where the screen appears to be split horizontally. Edge tears appear when the video feed is out of sync with the refresh rate of the display device.

EDID (Extended Display Identification Data)

Information stored in the projector that can be read by the source.

EDID is used on the HDMI, DVI and VGA inputs, allowing the source to automatically configure to the optimum display settings.

EDTV (Enhanced Definition Television)

A [progressive](#) digital television system with a lower resolution than [HDTV](#).

Field

In [interlaced video](#), a part of the image [frame](#) that is scanned separately. A field is a collection of either all the odd lines or all the even lines within the frame.

Frame

One of the many still images displayed in a sequence to create a moving picture. A frame is made of horizontal lines of [pixels](#). For example, a 1920x1080 frame consists of 1080 lines, each containing 1920 pixels. In analog video frames are scanned one at a time ([progressive scanning](#)) or split into [fields](#) for each field to be scanned separately ([interlaced video](#)).

Frame rate

The number of [frames](#) shown per second (fps). In TV and video, a frame rate is the rate at which the display device scans the screen to “draw” the frame.

Frame rate multiplication

To stop low [frame rate](#) 3D images from flickering, frame rate multiplication can be used, which increases the displayed frame rate by two or three times.

Notes

Gamma

A nonlinear operation used to code and decode [luminance](#). It originates from the Cathode Ray Tube technology used in legacy television sets.

Ghosting

An artifact in 3D image viewing. Ghosting occurs when an image intended for one eye is partially seen by the other eye.

Ghosting can be removed by optimizing the [dark time](#) and sync delay.

HDCP (High-bandwidth Digital Content Protection)

An encryption scheme used to protect video content.

HDTV (High Definition Television)

A television system with a higher [resolution](#) than [SDTV](#) and [EDTV](#). It can be transmitted in various formats, notably [1080p](#) and 720p.

Hertz (Hz)

Cycles per second.

Horizontal Scan Rate

The rate at which the lines of the incoming signal are refreshed. The rate is set by the horizontal [synchronization](#) from the source and measured in [Hertz](#).

Hs + Vs

Horizontal and vertical [synchronization](#).

Hue

The graduation (red/green balance) of color (applicable to [NTSC](#)).

Notes

Interlacing

A method of updating the image. The screen is divided in two [fields](#), one containing every odd horizontal line, the other one containing the even lines. The fields are then alternately updated. In analog TV interlacing was commonly used as a way of doubling the refresh rate without consuming extra bandwidth.

Interleaving

The alternation between left and right eye images when displaying 3D.

LED (Light Emitting Diode)

An electronic component that emits light.

Letterboxing

Black margins at the top and bottom of the image. Letterboxing appears when a wider image is packed into a narrower [frame](#) without changing the original [aspect ratio](#).

Lumen

A photometric unit of radiant power. For projectors, it is normally used to specify the total amount of emitted visible light.

Luminance

Also known as '[Y](#)', this is the part of a [Component Video](#) signal which affects the brightness, i.e. the black and white part.

Noise

Electrical interference displayed on the screen.

NTSC (National Television Standards Committee)

The United States standard for television - 525 lines transmitted at 60 [interlaced fields](#) per second.

Notes

OSD (on-screen display)

The projector menus allowing you to adjust various settings.

Overlapping region

See [blend region](#).

PAL (Phase Alternate Line)

The television system used in the UK, Australia and other countries - 625 lines transmitted at 50 [interlaced fields](#) per second.

Pillarboxing

Black margins at the left and right of the image. Pillarboxing appears when a narrower image is packed into a wider [frame](#) without changing the [aspect ratio](#).

Pixel

Short for *Picture Element*. The most basic unit of an image. Pixels are arranged in lines and columns. Each pixel corresponds to a micromirror within the [DMD™](#); resolutions reflect the number of pixels per line by the number of lines. For example, a [1080p](#) projector contains 1080 lines, each consisting of 1920 pixels.

Pond of mirrors

Area around the periphery of the [DMD™](#) containing inactive mirrors. The pond of mirrors may cause artifacts, for example during the [edge blending](#) process.

Pr, Pb

[Color difference](#) signals used with 'Y' for analog [Component Video](#) inputs. They provide information about the signal color. Not to be confused with [Cr, Cb](#).

Primary colors

Three colors any two of which cannot be mixed to produce the third. In additive color television systems the primary colors are red, green and blue.

Notes

Progressive scanning

A method of updating the image in which the lines of each **frame** are drawn in a sequence, without **interlacing**.

Pulldown

The process of converting a 24 fps film footage to a video **frame rate** (25 fps for **PAL/SECAM**, 30 fps for **NTSC**) by adding extra **frames**. DP projectors automatically carry out reverse pulldown whenever possible.

Resolution

The number of **pixels** in an image, usually represented by the number of pixels per line and the number of lines (for example, 1920 x 1200).

RGB (Red, Green and Blue)

An uncompressed **Component Video** standard.

Saturation

The amount of color in an image.

Scope

An **aspect ratio** of 2.35:1.

SDTV (Standard Definition Television)

An **interlaced** television system with a lower **resolution** than **HDTV**. For **PAL** and **SECAM** signals, the resolution is 576i; for **NTSC** it is 480i.

SECAM (Sequential Color with Memory)

The television system used in France, Russia and some other countries - 625 lines transmitted at 50 **interlaced fields** per second.

SX+

A display **resolution** of 1400 x 1050 pixels with a 4:3 screen **aspect ratio**. (Shortened from SXGA+, stands for *Super Extended Graphics Array Plus*.)

Notes

Synchronization

A timing signal used to coordinate an action.

Test pattern

A still image specially prepared for testing a projection system. It may contain various combinations of colors, lines and geometric shapes.

TheaterScope

An [aspect ratio](#) used in conjunction with a special [anamorphic lens](#) to display 2.35:1 images packed into a 16:9 [frame](#).

Throw distance

The distance between the screen and the projector.

Throw ratio

The ratio of the [throw distance](#) to the screen width.

TRC (Throw ratio correction)

A special number used in calculating [throw distances](#) and [throw ratios](#) when the image does not fill the width of the [DMD™](#).

TRC is the ratio of the [DMD™ aspect ratio](#) to the image source aspect ratio:

$$TRC = \frac{DMD^{\text{TM}} \text{ aspect ratio}}{\text{Source aspect ratio}}$$

TRC is only used in calculations if it is greater than 1.

UXGA

A display [resolution](#) of 1600 x 1200 [pixels](#) with a 4:3 screen [aspect ratio](#). (Stands for *Ultra Extended Graphics Array*.)

Notes

Vertical Scan Rate

The rate at which the [frames](#) of the incoming signal are refreshed. The rate is set by the vertical [synchronization](#) from the source and measured in [Hertz](#).

Vignetting

Optical cropping of the image caused by the components in the projection lens. This can happen if too much offset is applied when positioning the image using the lens mount.

Vista

An [aspect ratio](#) of 1.66:1.

WUXGA

A display [resolution](#) of 1920 x 1200 [pixels](#) with a 16:10 screen [aspect ratio](#). (Stands for Widescreen *Ultra Extended Graphics Array*.)

Y

This is the [luminance](#) input ([brightness](#)) from a [Component Video](#) signal.

YUV

See [Pr](#), [Pb](#).

ZScreen

A special kind of light modulator which polarizes the projected image for 3D viewing. It normally requires that images are projected onto a silver screen. The ZScreen is placed between the projector lens and screen. It changes the polarization of the projected light and switches between left- and right-handed circularly polarized light at the field rate.

Notes

This page is intentionally left blank.



Digital Projection Limited

Greenside Way, Middleton
Manchester M24 1XX, UK

*Registered in England No. 2207264
Registered Office: as above*

Tel (+44) 161 947 3300
Fax (+44) 161 684 7674

enquiries@digitalprojection.co.uk
service@digitalprojection.co.uk

www.digitalprojection.co.uk

Digital Projection Inc.

55 Chastain Road, Suite 115
Kennesaw, GA 30144, USA

Tel (+1) 770 420 1350
Fax (+1) 770 420 1360

powerinfo@digitalprojection.com
www.digitalprojection.com

Digital Projection China

中国 北京市 朝阳区 芍药居北里101号
世奥国际中心A座2006室(100029)

Rm A2006
ShaoYaoJu 101 North Lane
Shi Ao International Center
Chaoyang District
Beijing 100029, PR CHINA

Tel (+86) 10 84888566
Fax (+86) 10 84888566-805

techsupport@dp-china.com.cn
www.dp-china.com.cn

Contact Information:**Digital Projection Asia**

16 New Industrial Road
#02-10 Hudson Technocentre
Singapore 536204

Tel (+65) 6284-1138
Fax (+65) 6284-1238

www.digitalprojectionasia.com