

elipson® | planet L | wall mount

Cher Client,
 Merci d'avoir choisi les produits Elipson.
 Prenez le temps de lire attentivement
 ce mode d'emploi avant d'installer ce support.

Dear Customer,
 Thank you for choosing Elipson products.
 Take time to read this manual carefully
 before installing this wall mount.





Planet L | Support mural
Ce support mural pour Planet L est doté d'une très grande flexibilité.
D'un geste, vous pourrez orienter le son dans la direction de votre choix,
pour un confort d'écoute optimale.

Caractéristiques
 Dimensions : L60 x H233 x P227 mm
 Poids : 1,9 kg / 2 pièces
 Finition : acier brossé

Planet L | Wall mount
This wall bracket for Planet L has a very high flexibility.
With one touch you can direct the sound in the direction of your choice
for an optimal listening comfort.

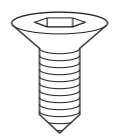
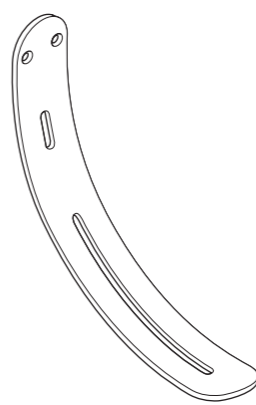
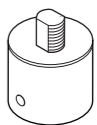
Specifications
 Dimensions: W60 x H233 x D227 mm
 Weight: 1,9 kg / 2 pcs
 Finish: brushed chrome

Dans le colis | In the box

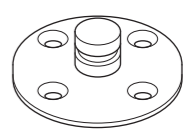
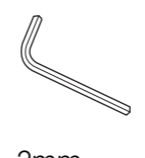
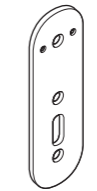
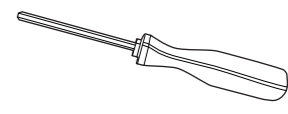
A1		x4	B1		x2	B3		x2
A2		x2		B4		x2		
A3		x1	x2	B5		x2		
A4		x1	B2		x2	B6		x1
								3mm

Étape 1 | Step 1

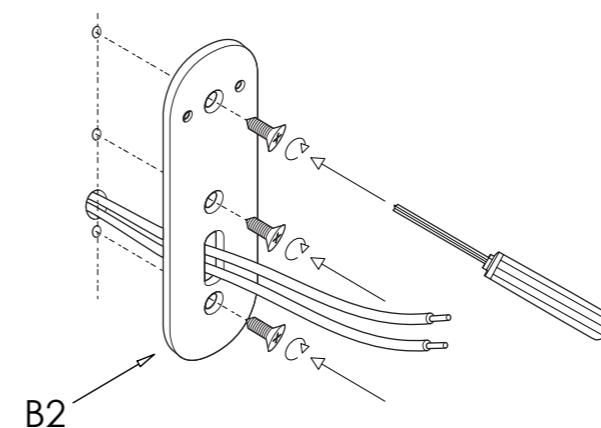

Étape 2 | Step 2

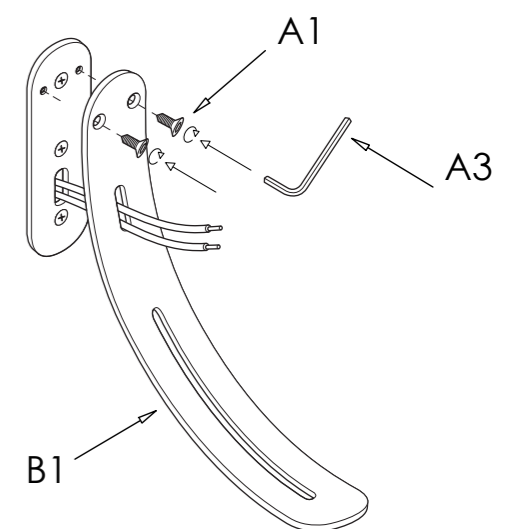

⚠ Les vis et le tournevis de cette illustration ne sont pas inclus. Choisissez les vis M4 de montage en fonction de la nature votre mur. **Poids de l'ensemble monté : 8Kgs**
Éteignez l'amplificateur avant toute manipulation.

⚠ Screws and screwdriver on this illustration are not provided. Choose screws for mounting according to your wall material. **Mounted assembly weight: 8Kgs | 18Lbs**
Turn off the amplifier before any handling.

INOVADIS

314 rue du Professeur Paul Milliez 94506 Champigny Cedex - France
 Elipson est une marque déposée du groupe INOVADIS. Elipson is a registered trademark of INOVADIS.

Étape 3 | Step 3

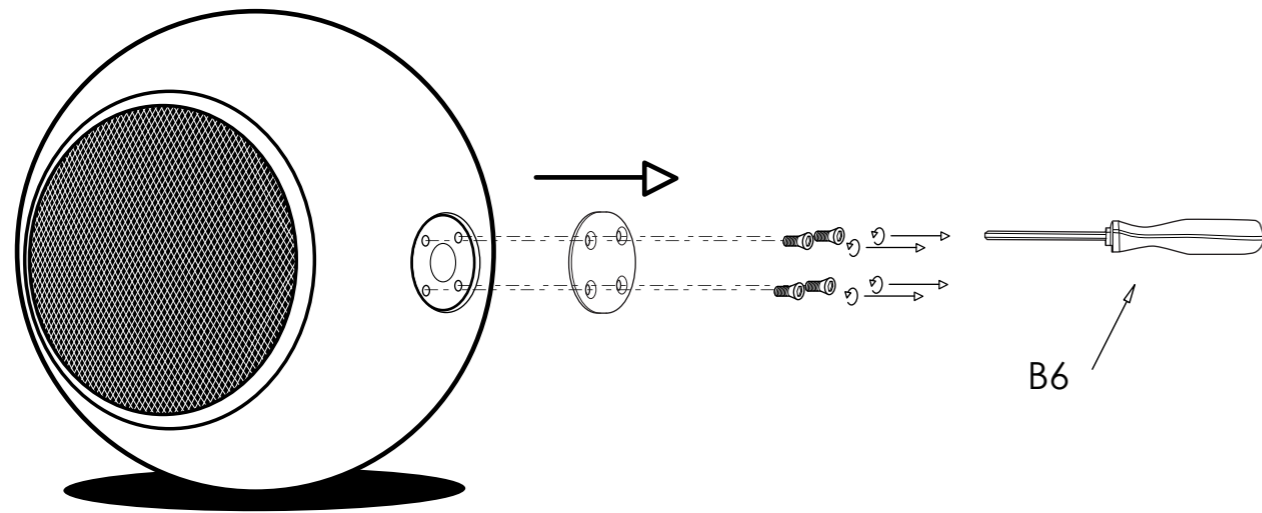

Étape 6 | Step 6

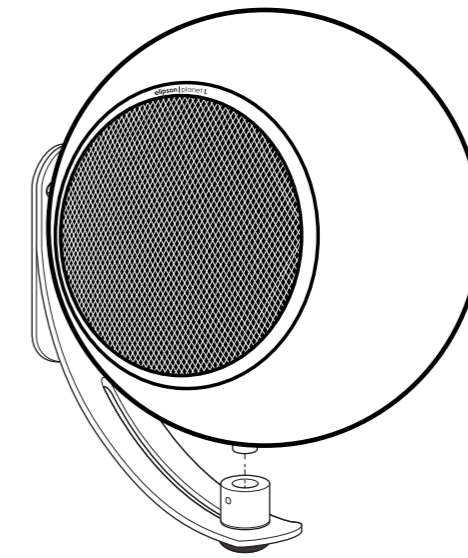

Étape 4 | Step 4

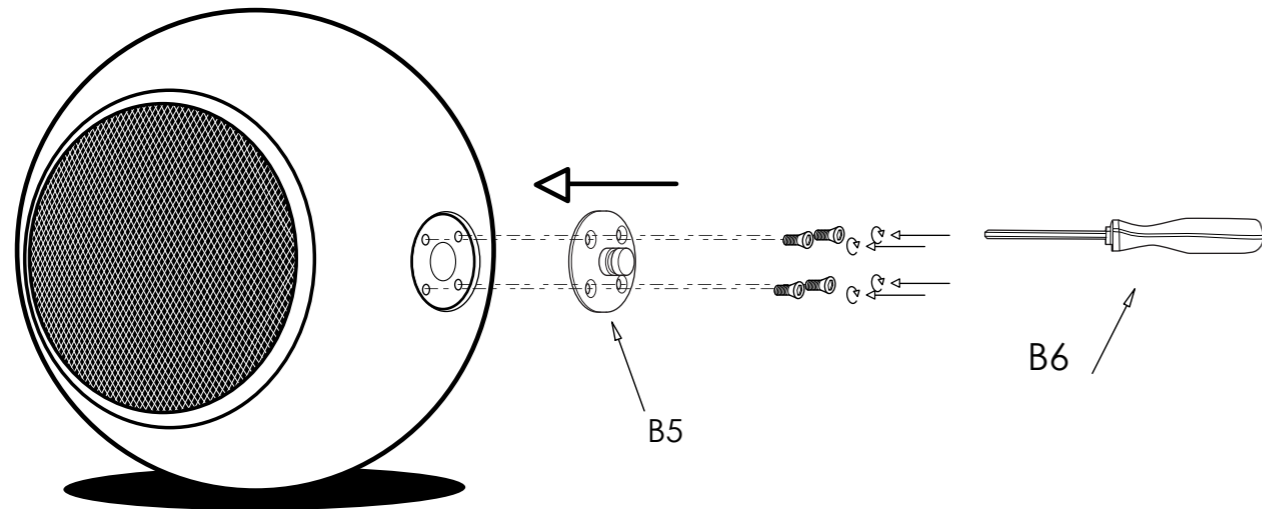

Étape 7 | Step 7

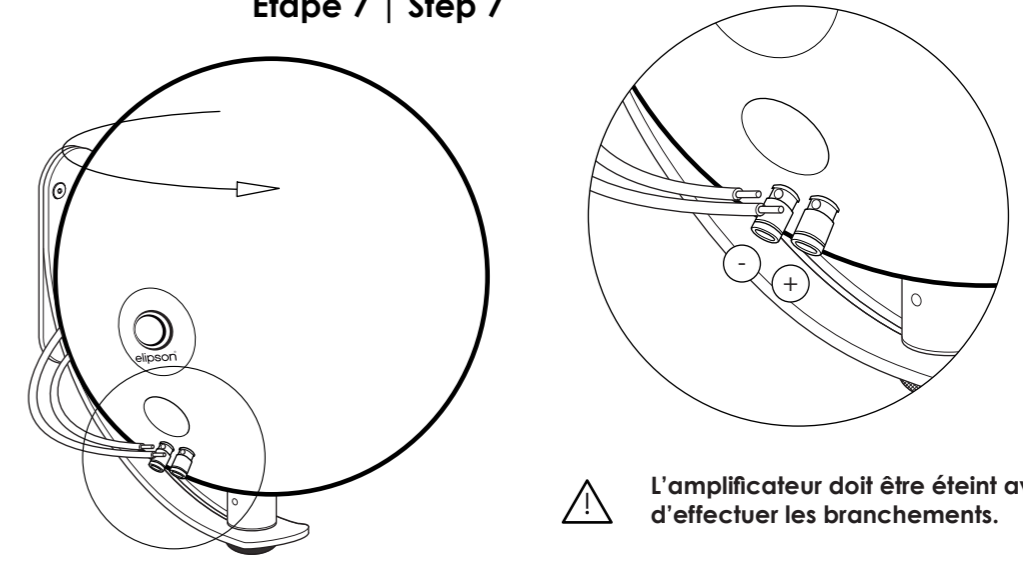

⚠ L'amplificateur doit être éteint avant d'effectuer les branchements.
 ⚠ Amplifier must be turned off before plugging the cables.

Étape 5 | Step 5

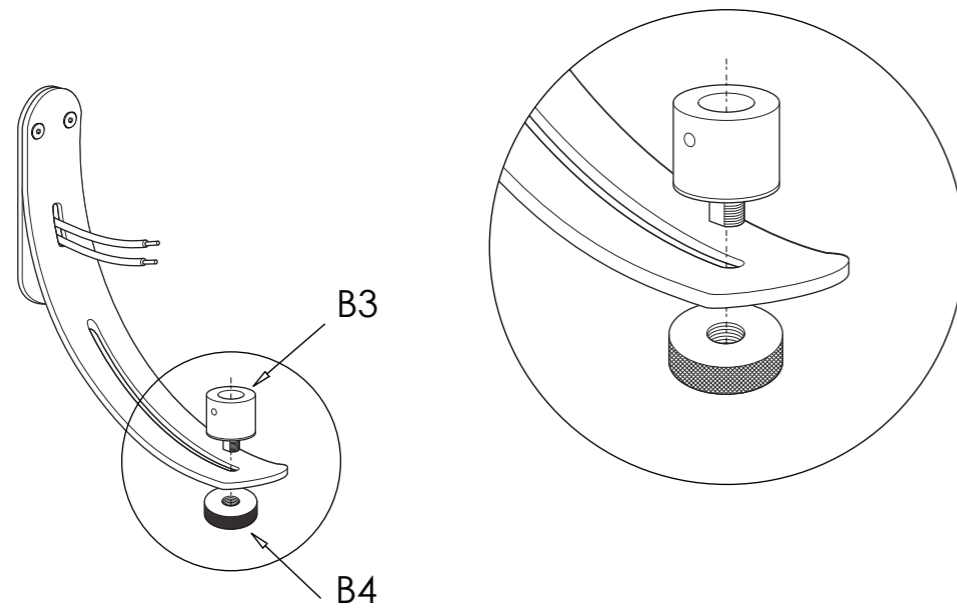

Étape 8 | Step 8

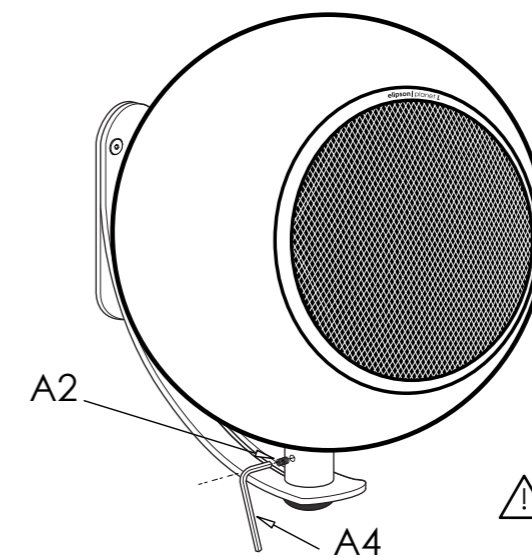

⚠ Verrouillez le support après avoir orienté l'enceinte dans la direction de votre choix.
 ⚠ Point the speaker as wished before locking the support.