

## 5.1 MAINTENANCE

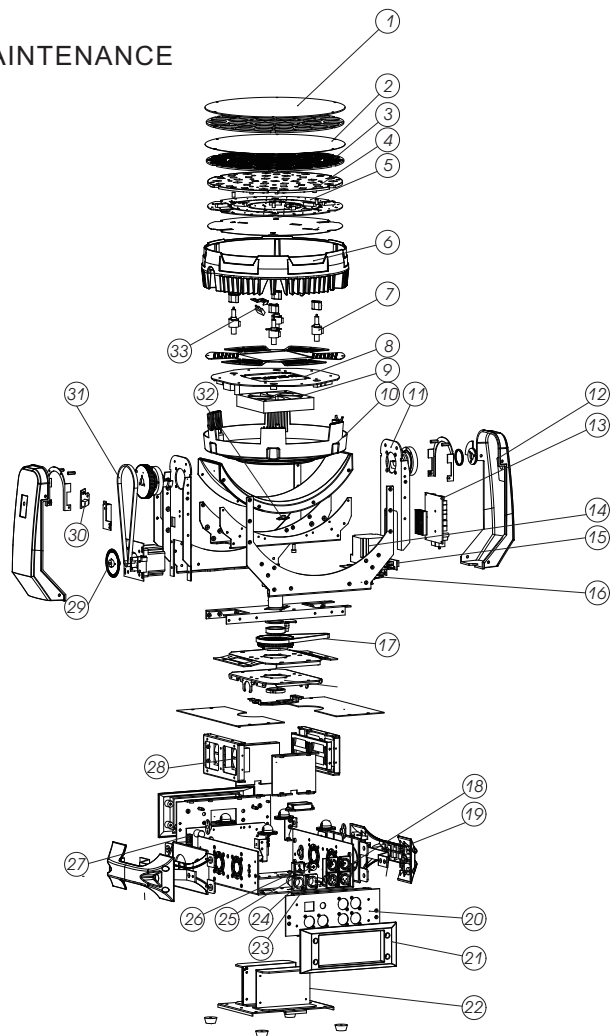

NO	Part name	NO	Part name	NO	Part name
1	Dust cover	12	Plastic arm	23	PS socket (male)
2	Frosted flakes	13	Motor driver PCB	24	PS socket (male)
3	Focus cover	14	Three-phase stepper motor	25	Fuse holder
4	Reflective bowl	15	Optical stopper sensor	26	Power switch
5	LED board	16	Optical wheel	27	Display board
6	Lamp cap	17	Synchronous belt	28	Fan
7	Linear motor	18	Adaptor PCB	29	Y-Small gear
8	LED driver PCB	19	Base handle	30	Magnetic stopper sensor
9	Slide block	20	End cap plate	31	Synchronous belt
10	Back cover	21	Base plastic cover	32	Magnetic stopper sensor
11	Arm etagere	22	Power Supply (PS)	33	Thermal switch

# CYAN 12000XCE MK3/MK4

## USER MANUAL

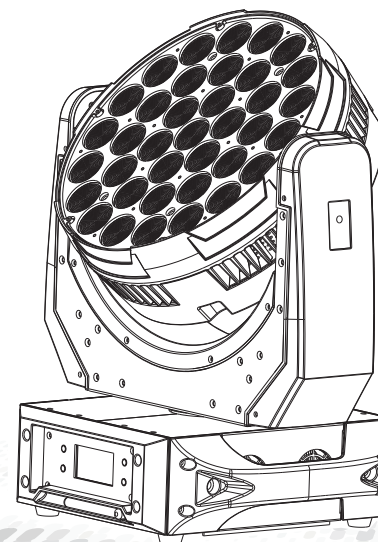

SS644

# 1 PRODUCT SPECIFICATIONS

## 1.1 PRODUCT SPECIFICATIONS

### Electrical

- ~ Voltage:AC100~240V 50/60Hz
- ~ Max Power:570W
- ~ Size:410X310X396mm
- ~ Weight:16.5kg

## 1.2 PRODUCT FEATURES

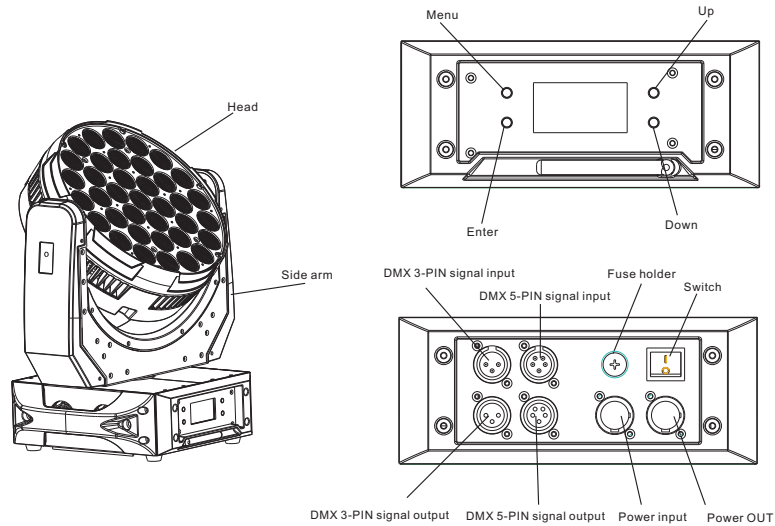

## PERSON6

CHANNEL	FUNCTION	VALUE	EFFECT
1	PAN	000 ↔ 255	0~540°
2	PAN FINE	000 ↔ 255	0~3°
3	TILT	000 ↔ 255	0~270°
4	TILT FINE	000 ↔ 255	0~3°
5	PAN/TILT SPEED	000 ↔ 255	From fast to slow
6	DIMMER	000 ↔ 255	Dark to light
7	STROBE	000 ↔ 009 010 ↔ 255	NO function 1~20Hz
8	ZOOM	000 ↔ 255	Since the zoom
9	CONTROL	000 ↔ 019 020 ↔ 039 040 ↔ 059 060 ↔ 079 080 ↔ 099 100 ↔ 119 120 ↔ 139 140 ↔ 149 150 ↔ 159 160 ↔ 169 170 ↔ 179 180 ↔ 199 200 ↔ 219 220 ↔ 235 236 ↔ 239 240 ↔ 243 244 ↔ 247 248 ↔ 251 252 ↔ 255	NO FUNCTION PAN/TILT BLACK ACTIVATED PAN/TILT BLACK DEACTIVATED FAN AUTO FAN SLOW FAN NORMAL FAN FAST AUTO1 AUTO2 TEST CUSTOM NO FUNCTION RESET(Delay 3 seconds) NO FUNCTION DIM0 DIM1 DIM2 DIM3 DIM4
10	RED1	000 ↔ 255	RED1
11	GREEN1	000 ↔ 255	GREEN1
12	BLUE1	000 ↔ 255	BLUE1
13	RED2	000 ↔ 255	RED2
14	GREEN2	000 ↔ 255	GREEN2
15	BLUE2	000 ↔ 255	BLUE2
16	RED3	000 ↔ 255	RED3
17	GREEN3	000 ↔ 255	GREEN3
18	BLUE3	000 ↔ 255	BLUE3
19	RED4	000 ↔ 255	RED4
20	GREEN4	000 ↔ 255	GREEN4
21	BLUE4	000 ↔ 255	BLUE4

CHANNEL	FUNCTION	VALUE	EFFECT
11	RED1	000 ↔ 255	RED1
12	RED1 FINE	000 ↔ 255	RED1 FINE
13	GREEN1	000 ↔ 255	GREEN1
14	GREEN1 FINE	000 ↔ 255	GREEN1 FINE
15	BLUE1	000 ↔ 255	BLUE1
16	BLUE1 FINE	000 ↔ 255	BLUE1 FINE
17	WHITE1	000 ↔ 255	WHITE1
18	WHITE1 FINE	000 ↔ 255	WHITE1 FINE
19	RED2	000 ↔ 255	RED2
20	RED2 FINE	000 ↔ 255	RED2 FINE
21	GREEN2	000 ↔ 255	GREEN2
22	GREEN2 FINE	000 ↔ 255	GREEN2 FINE
23	BLUE2	000 ↔ 255	BLUE2
24	BLUE2 FINE	000 ↔ 255	BLUE2 FINE
25	WHITE2	000 ↔ 255	WHITE2
26	WHITE2 FINE	000 ↔ 255	WHITE2 FINE
27	RED3U	000 ↔ 255	RED3U
28	RED3UFINE	000 ↔ 255	RED3UFINE
29	GREEN3U	000 ↔ 255	GREEN3U
30	GREEN3U FINE	000 ↔ 255	GREEN3U FINE
31	BLUE3U	000 ↔ 255	BLUE3U
32	BLUE3U FINE	000 ↔ 255	BLUE3U FINE
33	WHITE3U	000 ↔ 255	WHITE3U
34	WHITE3U FINE	000 ↔ 255	WHITE3U FINE
35	RED3D	000 ↔ 255	RED3D
36	RED3DFINE	000 ↔ 255	RED3DFINE
37	GREEN3D	000 ↔ 255	GREEN3D
38	GREEN3D FINE	000 ↔ 255	GREEN3D FINE
39	BLUE3D	000 ↔ 255	BLUE3D
40	BLUE3D FINE	000 ↔ 255	BLUE3D FINE
41	WHITE3D	000 ↔ 255	WHITE3D
42	WHITE3DFINE	000 ↔ 255	WHITE3DFINE
43	RED4U	000 ↔ 255	RED4U
44	RED4UFINE	000 ↔ 255	RED4UFINE
45	GREEN4U	000 ↔ 255	GREEN4U
46	GREEN4U FINE	000 ↔ 255	GREEN4U FINE
47	BLUE4U	000 ↔ 255	BLUE4U
48	BLUE4U FINE	000 ↔ 255	BLUE4U FINE
49	WHITE4U	000 ↔ 255	WHITE4U
50	WHITE4U FINE	000 ↔ 255	WHITE4U FINE
51	RED4D	000 ↔ 255	RED4D
52	RED4DFINE	000 ↔ 255	RED4DFINE
53	GREEN4D	000 ↔ 255	GREEN4D
54	GREEN4D FINE	000 ↔ 255	GREEN4D FINE
55	BLUE4D	000 ↔ 255	BLUE4D
56	BLUE4D FINE	000 ↔ 255	BLUE4D FINE
57	WHITE4D	000 ↔ 255	WHITE4D
58	WHITE4DFINE	000 ↔ 255	WHITE4DFINE

## 1.3 SAFETY WARNING

### IMPORTANT

This product must be installed by a qualified professional.

All maintenance must be carried out by a qualified electrician.

A minimum distance of 0.5m must be maintained between the equipment and a combustible surface.

The product must always be operated in a well ventilated area.

DO NOT stare directly into the LED light source.

Always disconnect the power before carrying out any maintenance.

The earth must always be connected to the ground.

Ensure that all parts of the equipment are kept clean and free of dust.

## 2 INSTALLATION

### 2.1 MOUNTING

The fixture can be mounted in any position.

Always ensure that mounting surface can withstand 10 times the weight of the fixture.

Always use a safety cable when mounting the fixture in any elevated position.

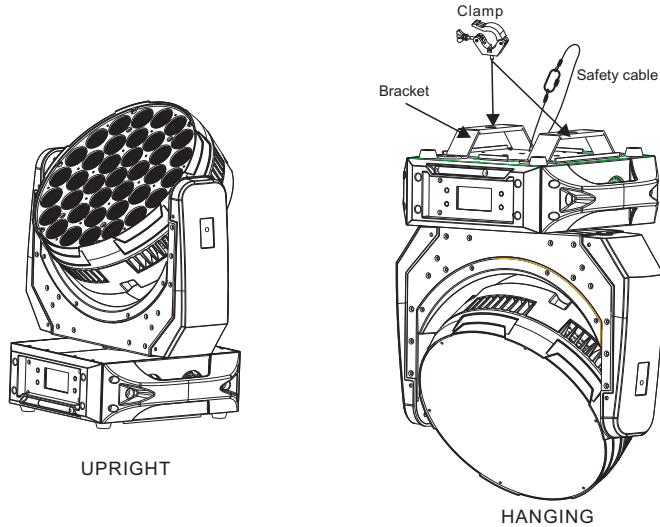

#### IMPORTANT SAFETY NOTE!!

Always use a safety cable when installing this unit!!

Be sure that the safety cable is connected to a solid load-bearing structure.

### 2.2 POWER CONNECTIONS

220~240V: 4 units may be connected in series

110~120V: 2units may be connected in series



#### Note:

If the signal cable is over 60m between the DMX512 controller and fixture or between two fixtures, then a DMX signal amplifier is needed as well.

## PERSON5

CHANNEL	FUNCTION	VALUE	EFFECT
1	PAN	000 ⇄ 255	0~540°
2	PAN FINE	000 ⇄ 255	0~3°
3	TILT	000 ⇄ 255	0~270°
4	TILT FINE	000 ⇄ 255	0~3°
5	PAN/TILT SPEED	000 ⇄ 255	From fast to slow
6	DIMMER	000 ⇄ 255	Dark to light
7	DIMMER FINE	000 ⇄ 255	Dark to light
8	STROBE	000 ⇄ 009 010 ⇄ 255	NO function 1~20Hz
9	ZOOM	000 ⇄ 255	Since the zoom
10	CONTROL	000 ⇄ 019 020 ⇄ 039 040 ⇄ 059 060 ⇄ 079 080 ⇄ 099 100 ⇄ 119 120 ⇄ 139 140 ⇄ 149 150 ⇄ 159 160 ⇄ 169 170 ⇄ 179 180 ⇄ 199 200 ⇄ 219 220 ⇄ 235 236 ⇄ 239 240 ⇄ 243 244 ⇄ 247 248 ⇄ 251 252 ⇄ 255	NO FUNCTION PAN/TILT BLACK ACTIVATED PAN/TILT BLACK DEACTIVATED FAN AUTO FAN SLOW FAN NORMAL FAN FAST AUTO1 AUTO2 TEST CUSTOM NO FUNCTION RESET(Delay 3 seconds) NO FUNCTION DIM0 DIM1 DIM2 DIM3 DIM4

## PERSON4

CHANNEL	FUNCTION	VALUE	EFFECT
1	PAN	000 ↔ 255	0~540°
2	PAN FINE	000 ↔ 255	0~3°
3	TILT	000 ↔ 255	0~270°
4	TILT FINE	000 ↔ 255	0~3°
5	PAN/TILT SPEED	000 ↔ 255	From fast to slow
6	DIMMER	000 ↔ 255	Dark to light 
7	STROBE	000 ↔ 009 010 ↔ 255	NO function 1~20Hz
8	ZOOM	000 ↔ 255	Since the zoom 
9	CONTROL	000 ↔ 019	NO FUNCTION
		020 ↔ 039	PAN/TILT BLACK ACTIVATED
		040 ↔ 059	PAN/TILT BLACK DEACTIVATED
		060 ↔ 079	FAN AUTO
		080 ↔ 099	FAN SLOW
		100 ↔ 119	FAN NORMAL
		120 ↔ 139	FAN FAST
		140 ↔ 149	AUTO1
		150 ↔ 159	AUTO2
		160 ↔ 169	TEST
		170 ↔ 179	CUSTOM
		180 ↔ 199	NO FUNCTION
		200 ↔ 219	RESET(Delay 3 seconds)
		220 ↔ 235	NO FUNCTION
236 ↔ 239	DIM0		
240 ↔ 243	DIM1		
244 ↔ 247	DIM2		
248 ↔ 251	DIM3		
252 ↔ 255	DIM4		
10	RED1	000 ↔ 255	RED1
11	GREEN1	000 ↔ 255	GREEN1
12	BLUE1	000 ↔ 255	BLUE1
13	WHITE1	000 ↔ 255	WHITE1
14	RED2	000 ↔ 255	RED2
15	GREEN2	000 ↔ 255	GREEN2
16	BLUE2	000 ↔ 255	BLUE2
17	WHITE2	000 ↔ 255	WHITE2
18	RED3	000 ↔ 255	RED3
19	GREEN3	000 ↔ 255	GREEN3
20	BLUE3	000 ↔ 255	BLUE3
21	WHITE3	000 ↔ 255	WHITE3
22	RED4	000 ↔ 255	RED4
23	GREEN4	000 ↔ 255	GREEN4
24	BLUE4	000 ↔ 255	BLUE4
25	WHITE4	000 ↔ 255	WHITE4

## 3 DISPLAY PANEL OPERATION

### 3.1 DISPLAY OPERATION

- ~ MENU BACK
- ~ ENTER ENTER OR SAVE
- ~ DOWN DOWN
- ~ UP UP

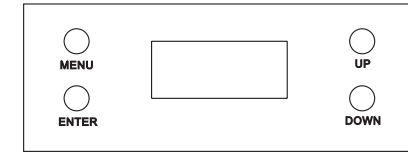



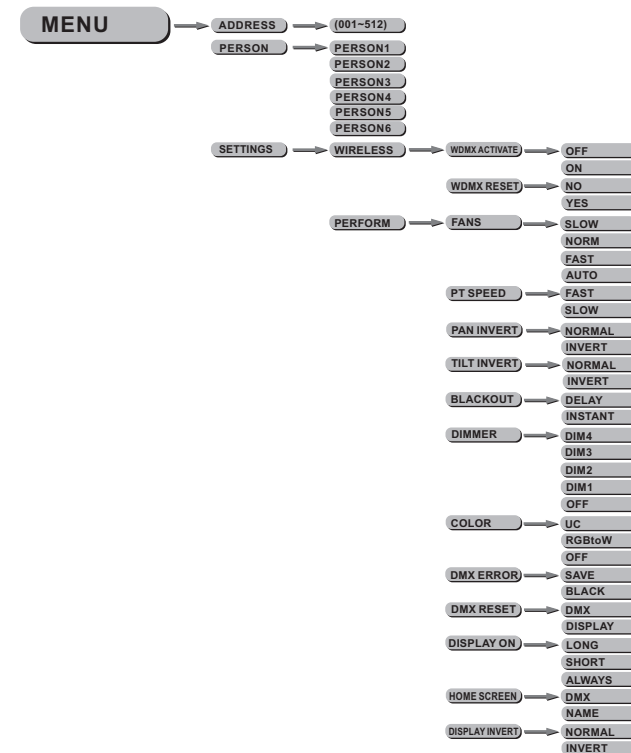

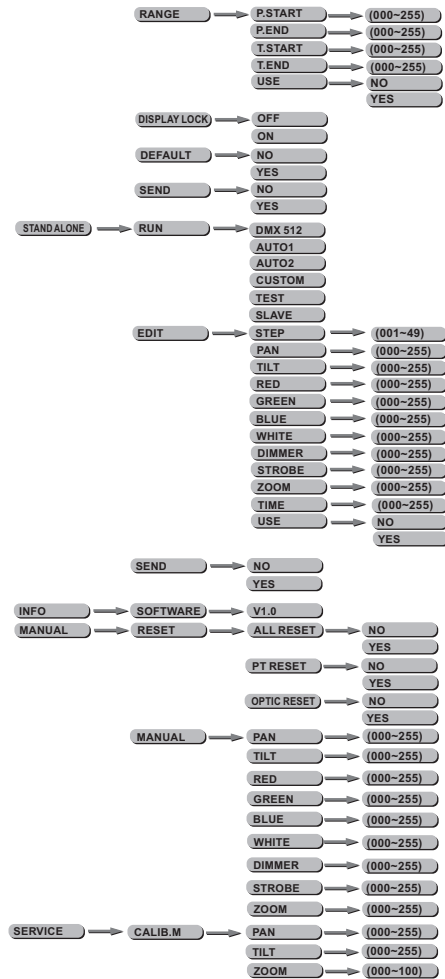
### 3.2 MENU MAP





### PERSON3

CHANNEL	FUNCTION	VALUE	EFFECT
1	PAN	000 ↔ 255	Clockwise rotate 0-540
2	TILT	000 ↔ 255	Fine control of tilt movement 0-270
3	HUE	000 ↔ 255	HUE
4	SATURATION	000 ↔ 255	SATURATION
5	VALUE	000 ↔ 255	VALUE
6	STROBE	000 ↔ 009 010 ↔ 255	NO function 1-20Hz
7	ZOOM	000 ↔ 255	Since the zoom 
8	CONTROL	000 ↔ 019 020 ↔ 039 040 ↔ 059 060 ↔ 079 080 ↔ 099 100 ↔ 119 120 ↔ 139 140 ↔ 149 150 ↔ 159 160 ↔ 169 170 ↔ 179 180 ↔ 199 200 ↔ 219 220 ↔ 235 236 ↔ 239 240 ↔ 243 244 ↔ 247 248 ↔ 251 252 ↔ 255	NO FUNCTION PAN/TILT BLACK ACTIVATED PAN/TILT BLACK DEACTIVATED FAN AUTO FAN SLOW FAN NORMAL FAN FAST AUTO1 AUTO2 TEST CUSTOM NO FUNCTION RESET(Delay 3 seconds) NO FUNCTION DIM0 DIM1 DIM2 DIM3 DIM4

CHANNEL	FUNCTION	VALUE	EFFECT
15	AUTO RINGS	000 ⇔ 009	ALL RINGS
		010 ⇔ 019	STATIC RING 1
		020 ⇔ 029	STATIC RING 2
		030 ⇔ 039	STATIC RING 3u
		040 ⇔ 049	STATIC RING 3d
		050 ⇔ 059	STATIC RING 4u
		060 ⇔ 069	STATIC RING 4d
		070 ⇔ 079	RING EFFECT 1: FILL centre-out with black (1, 1+2, 1+2+3, 1+2+3+4, 0)
		080 ⇔ 089	RING EFFECT 2: FILL centre-out no black (1, 1+2, 1+2+3, 1+2+3+4)
		090 ⇔ 099	RING EFFECT 3: FILL out-centre with black (1+2+3+4, 1+2+3, 2+1, 1, 0)
		100 ⇔ 109	RING EFFECT 4: FILL out-centre no black (1+2+3+4, 1+2+3, 2+1, 1)
		110 ⇔ 119	RING EFFECT 5: RING centre-out with black (1, 2, 3, 4, 0)
		120 ⇔ 129	RING EFFECT 6: RING centre-out noblack (1, 2, 3, 4)
		130 ⇔ 139	RING EFFECT 7: RING out-centre with black (4, 3, 2, 1, 0)
		140 ⇔ 149	RING EFFECT 8: RING out-centre with black (4, 3, 2, 1)
		150 ⇔ 159	RING EFFECT 9: DOT-FILL with blackout (1, 0, 1+2, 0, 1+2+3, 0, 1+1+3+4, 0)
		160 ⇔ 169	RING EFFECT 10: DOT-FILL no blackout (1, 1+2+3+4)
		170 ⇔ 179	RING EFFECT 11: BIG DOT STROBE (1+3, 0)
		180 ⇔ 189	RING EFFECT 12: THICK RING STROBE (2+4, 0)
		190 ⇔ 199	RING EFFECT 13: OUTER RING STROBE (1+3, 0, 2+4, 0)
200 ⇔ 209	RING EFFECT 14: OUTER RING STROBE (2+3+4, 0)		
210 ⇔ 219	RING EFFECT 15: RANDOM		
220 ⇔ 229	RING EFFECT 16: LINES ONEWAY (4u, 3u, 1+2, 3d, 4d)		
230 ⇔ 239	RING EFFECT 17: LINES WIDE ONEWAY (4u, 4u +3u, 3u+ 1+2, 1+2+3d, 3d+4d, 4d)		
240 ⇔ 249	RING EFFECT 18: LINES TWOWAY (4u, 3u, 1+2, 3d, 4d, 3d, 1+2, 3u)		
250 ⇔ 255	RING EFFECT 19: ALL RINGS		
16	AUTO SPEED	000 ⇔ 255	Slow to fast
17	DIMMER	000 ⇔ 255	Dark to light 
18	DIMMER FINE	000 ⇔ 255	Dark to light 
19	STROBE	000 ⇔ 009 010 ⇔ 255	NO function 1~20Hz
20	ZOOM	000 ⇔ 255	Since the zoom 
21	CONTROL	000 ⇔ 019	NO FUNCTION
		020 ⇔ 039	PAN/TILT BLACK ACTIVATED
		040 ⇔ 059	PAN/TILT BLACK DEACTIVATED
		060 ⇔ 079	FAN AUTO
		080 ⇔ 099	FAN SLOW
		100 ⇔ 119	FAN NORMAL
		120 ⇔ 139	FAN FAST
		140 ⇔ 149	AUTO1
		150 ⇔ 159	AUTO2
		160 ⇔ 169	TEST
		170 ⇔ 179	CUSTOM
		180 ⇔ 199	NO FUNCTION
		200 ⇔ 219	RESET(Delay 3 seconds)
		220 ⇔ 235	NO FUNCTION
		236 ⇔ 239	DIM0
		240 ⇔ 243	DIM1
		244 ⇔ 247	DIM2
		248 ⇔ 251	DIM3
		252 ⇔ 255	DIM4

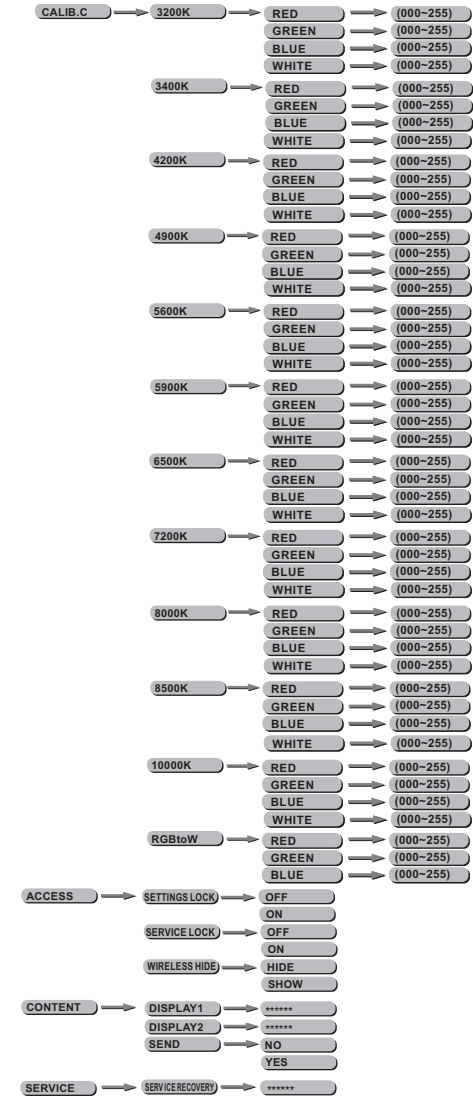

### 3.3 DMX512 SETTINGS



Enter the DMX mode to set the DMX ADDRESS.

### 3.4 PERSONALITY

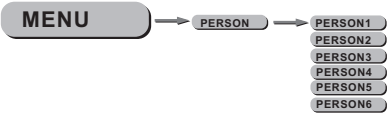

Enter the PERSONALITY mode to select DMX mode: PERSON1, PERSON2, PERSON3, PERSON4, PERSON5, PERSON6.

### 3.51 DATA

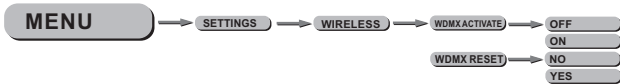

Select DATA from the SETTINGS menu.

WDMX ACTIVATE menu, select ON/OFF for WDMX activation

WDMX RESET menu, select NO/YES for resetting the WDMX function.

Please note that a fixture must be reset before it can be paired with a new WDMX transmitter.

### PERSON2

CHANNEL	FUNCTION	VALUE	EFFECT
1	PAN	000 ↔ 255	0~540°
2	PAN FINE	000 ↔ 255	0~3°
3	TILT	000 ↔ 255	0~270°
4	TILT FINE	000 ↔ 255	0~3°
5	PAN/TILT SPEED	000 ↔ 255	From fast to slow
6	RED	000 ↔ 255	RED
7	RED FINE	000 ↔ 255	RED FINE
8	GREEN	000 ↔ 255	GREEN
9	GREEN FINE	000 ↔ 255	GREEN FINE
10	BLUE	000 ↔ 255	BLUE
11	BLUE FINE	000 ↔ 255	BLUE FINE
12	WHITE	000 ↔ 255	WHITE
13	WHITE FINE	000 ↔ 255	WHITE FINE
14	COLOR/ WHITE MACRO	000 ↔ 005	NO FUNCTION
		006 ↔ 010	NO FUNCTION
		011 ↔ 030	RED 100% / GREEN UP / BLUE 0%
		031 ↔ 050	RED DOWN / GREEN 100% / BLUE 0%
		051 ↔ 070	RED 0% / GREEN 100% / BLUE UP
		071 ↔ 090	RED 0% / GREEN DOWN / BLUE 100%
		091 ↔ 110	RED UP / GREEN 0% / BLUE 100%
		111 ↔ 130	RED 100% / GREEN 0% / BLUE DOWN
		131 ↔ 150	RED 100% / GREEN UP / BLUE UP
		151 ↔ 170	RED DOWN / GREEN DOWN / BLUE 100%
		171 ↔ 200	RED 100% / GREEN 100% / BLUE 100% WHITE 100%
		201 ↔ 205	WHITE1: 3200K
		206 ↔ 210	WHITE2: 3400K
		211 ↔ 215	WHITE3: 4200K
216 ↔ 220	WHITE4: 4900K		
221 ↔ 225	WHITE5: 5600K		
226 ↔ 230	WHITE6: 5900K		
231 ↔ 235	WHITE7: 6500K		
236 ↔ 240	WHITE8: 7200K		
241 ↔ 245	WHITE9: 8000K		
246 ↔ 250	WHITE10: 8500K		
251 ↔ 255	WHITE11: 10000K		



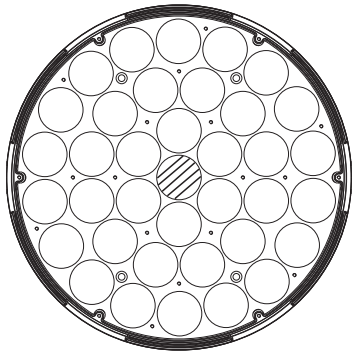

RING 1

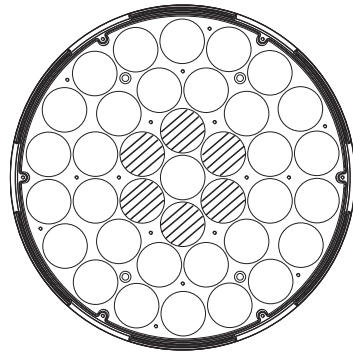

RING 2

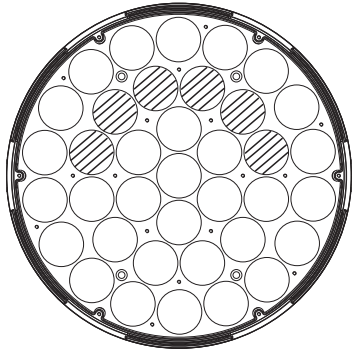

RING 3U

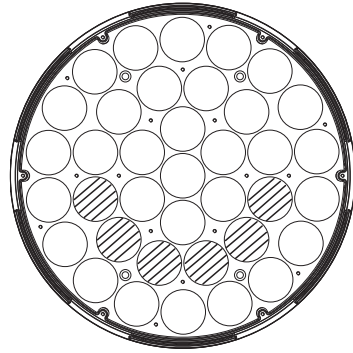

RING 3D

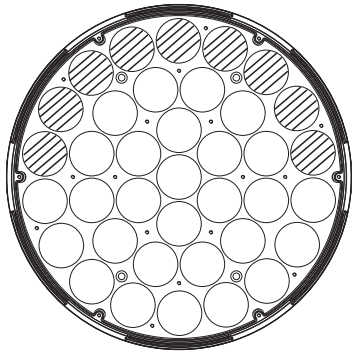

RING 4U

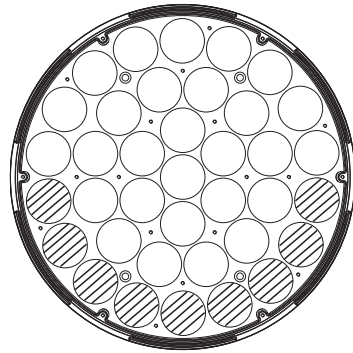

RING 4D

To identify up, middle and down by head which after the fixture electrify & reset

### 3.52 PERFORM

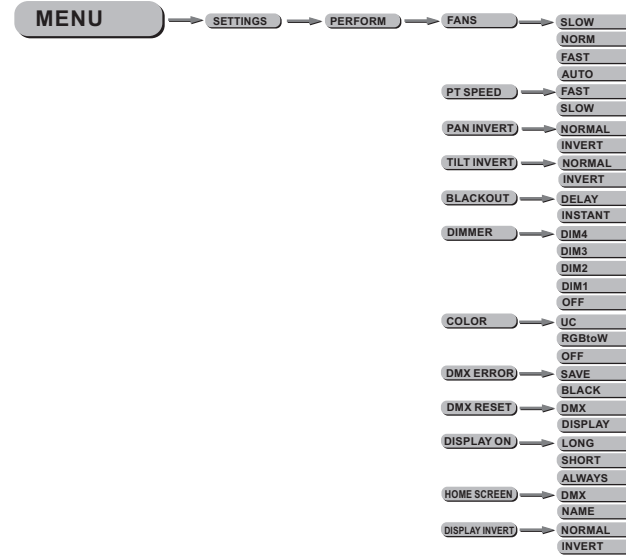

Select PERFORM from the SETTINGS menu.

FANS menu, select Slow/Norm/Fast/Auto as required fan speed.

PT SPEED menu, select Slow/Fast as required PAN/TILT movement speed.

PAN INVERT menu, select NORM/INVERT for normal/inverted control of the PAN function

TILT INVERT menu, select NORM/INVERT for normal/inverted control of the TILT function

BLACKOUT menu, select INSTANT for immediate activation of PAN/TILT blackout when selected using the control channel or DELAY for 3 second delay before activation. DIMMER menu for selection of

DIM1/DIM2/DIM3/DIM4/OFF special dimming curves

COLOR is for activate/unactivate the color calibration functions. When [RGBtoW] is selected, on RGB = 255,255,255, the color is displayed as calibrated in CAL2 -- RGBW. When [COLOR] is set [OFF], on RGB = 255,255,255, the RGB values are not adjusted and the output is most powerful. When [UC] is selected, the RGB output are adjusted to a standard preset universal color which balances fixtures from different generations.

DMX error menu, select SAVE to maintain last command in case of DMX error or BLACK for blackout

DMX reset menu, select DMX to allow remote reset using DMX controller or DISPLAY for reset only available at on-fixtured display

DISPLAY ON menu, select LONG/SHORT/ALWAYS for length of time for display backlight

HOME SCREEN menu, select DMX to display DMX address or NAME for product/manufacturer name

Display Invert menu, select NORMAL/INVERT display direction

### 3.53 INVERT



Select P.start / P.end / T.start / T.end to which is from (001–512)  
 Press USE is to set angle, choose NO to disable this function, choose YES to using this function.

### 3.54 DISPLAY LOCK



~ Choose the ~ Display lock ~ key lock Settings

### 3.55 DEFAULT



~ This functions will reset all setting to the original factory setting

## 4 USING A DMX512 CONTROLLER

### 4.1 CHANNEL ASSIGNMENT

Note: This product have six DMX512 channel configuration:  
**PERSON1 / PERSON2 / PERSON3 PERSON4**  
**PERSON5 . and PERSON6 .**

#### PERSON1

CHANNEL	FUNCTION	VALUE	EFFECT
1	PAN	000 ↔ 255	Clockwise rotate 0~540
2	TILT	000 ↔ 255	Fine control of tilt movement 0~270
3	RED	000 ↔ 255	RED
4	GREEN	000 ↔ 255	GREEN
5	BLUE	000 ↔ 255	BLUE
6	WHITE	000 ↔ 255	WHITE
7	DIMMER	000 ↔ 255	Dark to light
8	STROBE	000 ↔ 009 010 ↔ 255	NO function 1~20Hz
9	ZOOM	000 ↔ 255	Since the zoom
10	CONTROL	000 ↔ 019 020 ↔ 039 040 ↔ 059 060 ↔ 079 080 ↔ 099 100 ↔ 119 120 ↔ 139 140 ↔ 149 150 ↔ 159 160 ↔ 169 170 ↔ 179 180 ↔ 199 200 ↔ 219 220 ↔ 235 236 ↔ 239 240 ↔ 243 244 ↔ 247 248 ↔ 251 252 ↔ 255	NO FUNCTION PAN/TILT BLACK ACTIVATED PAN/TILT BLACK DEACTIVATED FAN AUTO FAN SLOW FAN NORMAL FAN FAST AUTO1 AUTO2 TEST CUSTOM NO FUNCTION RESET(Delay 3 seconds) NO FUNCTION DIM0 DIM1 DIM2 DIM3 DIM4

### 3.8 ACCESS



Select ACCESS from the SERVICE menu  
 SETTINGS LOCK menu, select OFF/ON to enable access to SETTINGS menu  
 SERVICE LOCK menu, select OFF/ON to enable access to SERVICE menu  
 WIRELESS HIDE menu, select HIDE/SHOW to show wireless options in settings menu

### 3.9 CONTENT

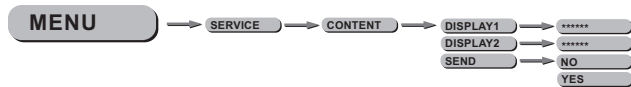

Select CONTENT from the SERVICE menu  
 DISPLAY 1 menu, edit first line of display content  
 DISPLAY 2 menu, edit second line of display content  
 SEND menu, select YES in order to transfer display content to all fixtures currently connected via data cable

### 3.10 SERVICE



- In order to reset custom modes to default values select [ REST ] .

### 3.56 SEND



Select SEND from the SETTINGS menu in order to send all settings to all fixtures currently linked via data cable

### 3.61 RUN

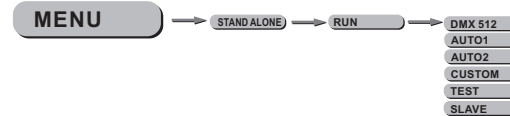

Enter the STAND ALONE menu to select from AUTO 1/AUTO 2/CUSTOM/TEST/SLAVE run modes

### 3.62 EDIT

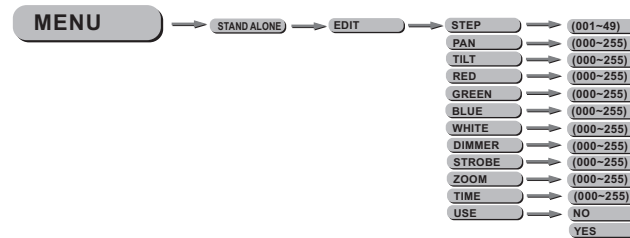

Enter the Edit mode to edit the custom programs by adjusting the value of Step , Pan , Tilt , Red , Green , Blue , White , Dimmer , Strobe , Zoom , Time  
 Enter Use and select Yes to run the steps user need.

Note: if user want to circulate the created steps, please set the last step s Time as 0

For example, there are 3 steps, the setting should be like belowed:

Step 1 Time = 4 Use = Yes  
 Step 2 Time = 5 Use = Yes  
 Step 3 Time = 0 Use = Yes

### 3.63 SEND



Select SEND from the STAND ALONE menu to send the CUSTOM program to all fixtures currently linked via data cable

### 3.64 INFO



Select INFO from the Stand alone menu in order to view the Software version UID number

### 3.65(1) MANUAL

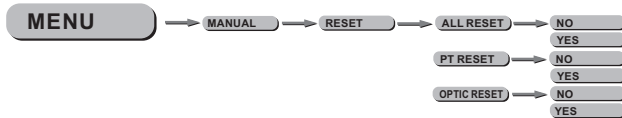

Select RESET from the MANUAL menu  
 ALL RESET menu, select YES/NO to carry out full fixture reset  
 PT RESET menu, select YES/NO to carry out PAN/TILT reset  
 OPTIC RESET menu, select YES/NO to carry out OPTIC reset

### 3.65(2) MANUAL

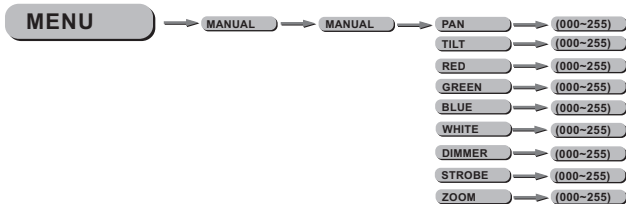

Select MANUAL from the MANUAL menu  
 Adjust the values of PAN/TILT/RED/GREEN/BLUE/WHITE/DIMMER/STROBE/ZOOM in order to carry out manual control

### 3.66 CALIB.M



Select CALIB.M from the SERVICE menu in order to calibrate the motors  
 Adjust the values of the PAN/TILT/ZOOM motors in order to calibrate the start motor position

### 3.7 CALIB

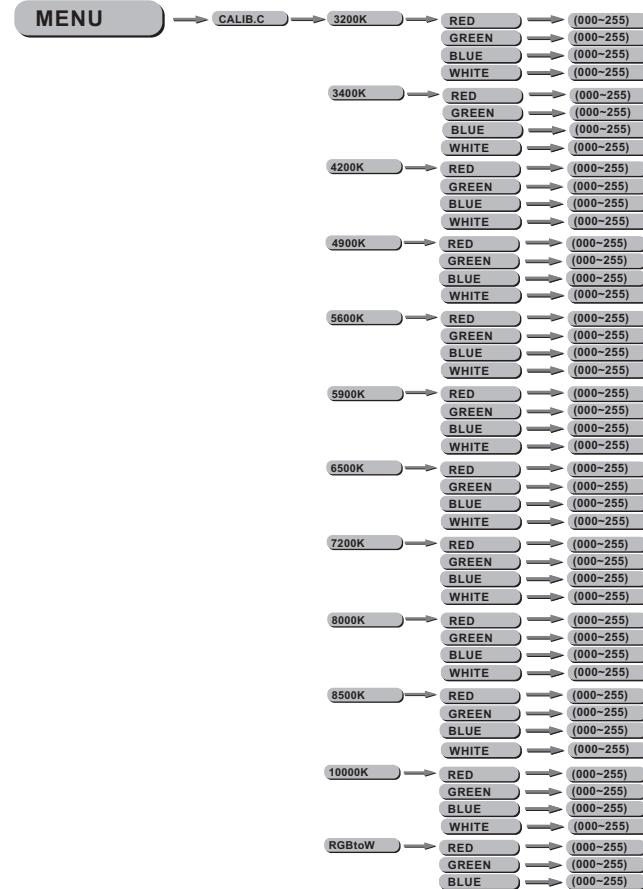

Enter the Calib to select white color of different color temperature.  
 There are 11 pre-programmed White colors plus RGB TO WHITE and can be edited by using Red, Green, Blue & White.