



CPLUS-V4H4H

4x4 4K UHD+ Matrix



4K2K

Operation Manual

DISCLAIMERS

The information in this manual has been carefully checked and is believed to be accurate. Cypress Technology assumes no responsibility for any infringements of patents or other rights of third parties which may result from its use.

Cypress Technology assumes no responsibility for any inaccuracies that may be contained in this document. Cypress also makes no commitment to update or to keep current the information contained in this document.

Cypress Technology reserves the right to make improvements to this document and/or product at any time and without notice.

COPYRIGHT NOTICE

No part of this document may be reproduced, transmitted, transcribed, stored in a retrieval system, or any of its part translated into any language or computer file, in any form or by any means—electronic, mechanical, magnetic, optical, chemical, manual, or otherwise—without express written permission and consent from Cypress Technology.

© Copyright 2015 by Cypress Technology.

All Rights Reserved.

TRADEMARK ACKNOWLEDGMENTS

All products or service names mentioned in this document may be trademarks of the companies with which they are associated.





SAFETY PRECAUTIONS

Please read all instructions before attempting to unpack, install or operate this equipment and before connecting the power supply.

Please keep the following in mind as you unpack and install this equipment:

- Always follow basic safety precautions to reduce the risk of fire, electrical shock and injury to persons.
- To prevent fire or shock hazard, do not expose the unit to rain, moisture or install this product near water.
- Never spill liquid of any kind on or into this product.
- Never push an object of any kind into this product through any openings or empty slots in the unit, as you may damage parts inside the unit.
- Do not attach the power supply cabling to building surfaces.
- Use only the supplied power supply unit (PSU). Do not use the PSU if it is damaged.
- Do not allow anything to rest on the power cabling or allow any weight to be placed upon it or any person walk on it.
- To protect the unit from overheating, do not block any vents or openings in the unit housing that provide ventilation and allow for sufficient space for air to circulate around the unit.

REVISION HISTORY

VERSION NO.	DATE (DD/MM/YY)	SUMMARY OF CHANGE
RDV1	09/11/15	Preliminary release



CONTENTS

1. Introduction	1
2. Applications	1
3. Package Contents	1
4. System Requirements	2
5. Features	2
6. Operation Controls and Functions	3
6.1 Front Panel	3
6.2 Rear Panel.....	4
6.3 Remote Control.....	5
6.4 IR Pin Definitions	6
6.5 RS-232 Protocols	6
6.6 Telnet and RS-232 Commands(not final version)	7
6.7 Telnet Control	10
6.8 WebGUI Control	11
7. Connection Diagram	21
8. Specifications	22
8.1 Technical Specifications	22
9. Timing	23





1. INTRODUCTION

This 4x4 4K UHD Matrix provides a high level of audio and video performance with support for resolutions up to 4K@60Hz (YUV 4:4:4, 8-bit) and pass-through support of digital audio formats including LPCM 7.1 (with sampling rates up to 192kHz), bitstream, and HD bitstream. The 4 HDMI inputs and 4 HDMI outputs support fully matrixed switching. A sophisticated WebGUI interface supports storing and recalling up to four routing presets, making remote control and configuration of the unit a breeze. Built in EDID management support allows the user select from multiple built in EDIDs as well as to upload custom EDID files and download the EDID from connected displays. Control is provided via front panel buttons, IR remote, WebGUI, RS-232, and telnet.

2. APPLICATIONS

- Video/TV wall display and control
- Security surveillance and control
- Commercial advertising, display and control
- University lecture hall, display and control
- Retail sales and demonstration

3. PACKAGE CONTENTS

- 1 x 4x4 4K UHD+ Matrix
- 1 x IR Extender
- 1 x OTG USB converter
- 1 x 24V/2.7A DC Power Adaptor
- 1 x IR Remote Control with Battery.
- 1 x Power Cord
- Operation Manual

4. SYSTEM REQUIREMENTS

- HDMI source equipment such as media players, video game consoles or set-top boxes.
- HDMI receiving equipment such as HDTVs, monitors or audio amplifiers.
- The use of "Premium High Speed HDMI" cables is highly recommended.

5. FEATURES

- HDMI inputs and outputs with 18Gbps (600MHz) 4K UHD support
- DVI 1.0 compliant with the use of an HDMI-DVI adaptor
- HDCP 1.4 and 2.2 compliant
- Supports HD resolutions up to 3840x2160@60 Hz (YUV 4:4:4, 8-bit) & 4096x2160@60 Hz (YUV 4:4:4, 8-bit)
- Supports 48-bit Deep Color up to 1080p60
- Supports 3D signal bypass
- Supports pass-through of LPCM 7.1, bitstream and HD bitstream audio formats over HDMI
- Provides powerful EDID management tools with 4 slots for user-created EDIDs, and EDID bypass support
- Supports storing and recall of up to four routing presets
- Controllable via front-panel buttons, RS-232, telnet, WebGUI, and IR remote

6. OPERATION CONTROLS AND FUNCTIONS

6.1 Front Panel

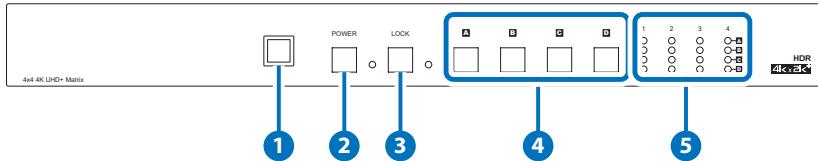

- 1 IR Window:** Accepts IR signals from the included IR remote for control of this unit only.
- 2 Power Button & LED:** Press this button to power the unit on (green LED) or place it into stand-by mode (red LED).
- 3 LOCK & LED:** Press to lock all button functions on the front panel. Press and hold for 3 seconds to release the lock function. The LED will be lit when the front panel is in the locked state.
- 4 A~D:** Press and hold these buttons to sequentially switch through the available inputs for the associated output.
- 5 LED 1~4:** These LEDs will illuminate to indicate which sources are currently selected for each output. No lit LED for an output indicates that that output is muted.

6.2 Rear Panel

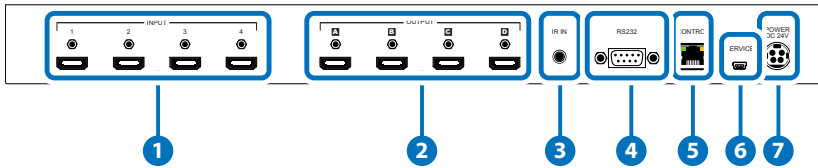

- 1 INPUT 1~4:** Connect to HDMI source equipment such as media players, game consoles or set-top boxes. DVI sources are supported with the use of an HDMI to DVI adapter.
- 2 OUTPUT A~D:** Connect to HDMI TVs, monitors or amplifiers for digital video and audio output.
- 3 IR IN:** Connect to the provided IR Extender to extend the IR control range of the unit. Ensure that the remote being used is within direct line-of-sight of the IR Extender.
- 4 RS232:** Connect directly to a PC, laptop or other serial control device to send RS-232 commands to control the unit.
- 5 Control:** Connect directly, or through a network switch, to your PC/ laptop to control the unit via telnet/WebGUI.
- 6 SERVICE:** This slot is reserved for firmware update use only.
- 7 DC 24V:** Plug the 24V DC power adapter into the unit and connect it to an AC wall outlet for power.

6.3 Remote Control

- 1 **POWER:** Press this button to power the unit on or place it into stand-by mode.
- 2 **OUTPUT A:** Press the number of the input (1~4) to display on Output A.
- 3 **OUTPUT B:** Press the number of the input (1~4) to display on Output B.
- 4 **OUTPUT C:** Press the number of the input (1~4) to display on Output C.
- 5 **OUTPUT D:** Press the number of the input (1~4) to display on Output D.

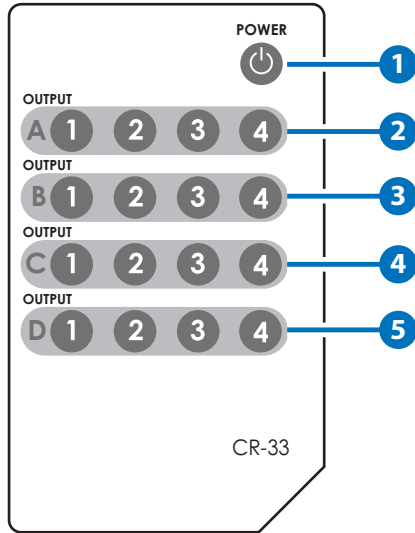

6.4 IR Pin Definitions

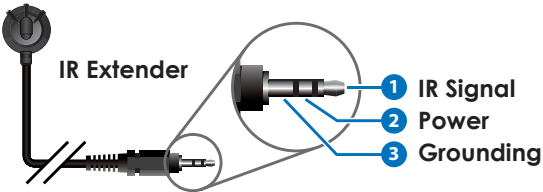

6.5 RS-232 Protocols

MATRIX	
Pin	Definition
1	NC
2	Tx
3	Rx
4	NC
5	GND
6	NC
7	NC
8	NC
9	NC



REMOTE CONTROLLER	
Pin	Definition
1	NC
2	Rx
3	Tx
4	NC
5	GND
6	NC
7	NC
8	NC
9	NC

Baud Rate: 115200bps
 Data bit: 8 bits
 Parity: None
 Flow Control: None
 Stop Bit: 1

6.6 Telnet and RS-232 Commands(not final version)

COMMAND	DESCRIPTION	DESCRIPTION OF PARAMETER
A N	Switch Output A to Input N	N=1~4
B N	Switch Output B to Input N	N=1~4
C N	Switch Output C to Input N	N=1~4
D N	Switch Output D to Input N	N=1~4
I N	Switch All Output to Input N	N=1~4
AB..... N	Switch output AB...to input N	N=1~4
SETIP x.x.x.x x.x.x.x x.x.x.x	Setting IP, Subnet, Gateway(Static IP)	X=0~255
IPCONFIG	Display The Current IP Configuration	NONE
RSTIP	Set IP Configuration to DHCP	NONE
P0	Power Off	NONE
P1	Power On	NONE
STORE N	Store Current I/O to Position N	N=1~4

COMMAND	DESCRIPTION	DESCRIPTION OF PARAMETER
SHOW N	Show Current Port N I/O Position	N=1~4
PRESET N	Preset the store I/O Position N	N=1~4
Name N N1	Name port N as N1	N=1~4
N1=ABCDEFGH(Max Length=8)		
ST	Show Unit Firmware Version	NONE
EM N N1	Setting port N EDID Mode to N1	N=1~4 N1= 1-FHD2CH, 2-FHDMCH, 3-4KUHD2CH, 4-4KUHDMCH, 5-4KUHD+2CH, 6-4KUHD+MCH, 7-TXA, 8-TXB, 9-TXC, 10-TXD, 11-USER1, 12-USER2, 13-USER3, 14-USER4

COMMAND	DESCRIPTION	DESCRIPTION OF PARAMETER
EM? N	Show port N current EDID mode.	N=1~4
RS	Routing Reset to Default	NONE
USBISP	Update FW by USB	NONE
HELP	Display all available commands and its description	NONE
?	Display all available commands	NONE
QUIT	Quit Telnet	NONE

Note: Commands will not be executed unless followed by a carriage return. Commands are not case-sensitive.

6.7 Telnet Control

the PC/Laptop are connected to the same active networks.

To access Telnet in Windows 7, click on the “Start” menu and type “cmd” in the search field, then press “Enter”.

Under Windows XP go to the “Start” menu, click on “Run”, type “cmd” then press “Enter”.

Under Mac OS X, go to Go→Applications→Utilities→Terminal

See below for reference.

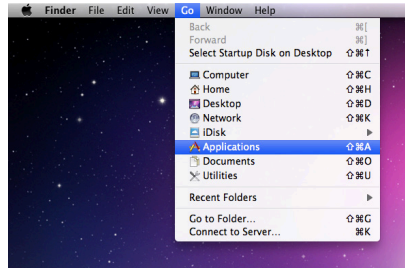
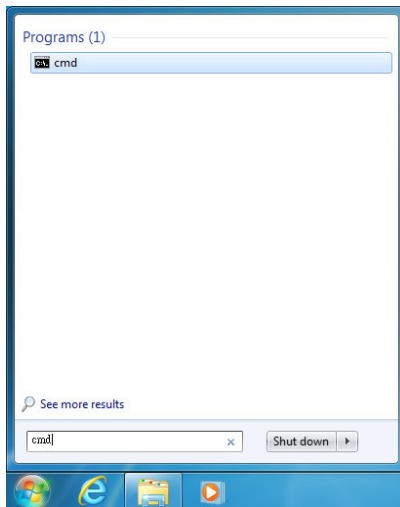

Once in the CLI (Command Line Interface) type “telnet” followed by the IP address of the unit (and the port number if it is non-standard) and then hit “Enter”.

```
Microsoft Windows [Version 6.1.7601]
Copyright (c) 2009 Microsoft Corporation. All rights reserved.

C:\Users\Administrator>telnet 192.168.5.80 23
```



This will connect us to the unit we wish to control. Type “help” to list the available commands.

```
HELP
? :SHOW DESCRIPT OF COMMAND
HELP :SHOW DESCRIPT OF COMMAND
SETIP :SET ETHERNET IP ADDRESS P1 P2 P3 P1=IPADDRESS, P2=NETMASK, P3=GATEWAY(P1-P3)=X.X.X.X (X=0-255)
IPCONFIG : DISPLAY THE CURRENT IPCONFIG
RSTIP : IP CONFIGURATION RESET TO <DHCP>
REBOOT : System Reset
PO : POWER OFF
P1 : POWER ON
STORE : STORE current I/O position (1-4)
SHOW : SHOW current port's I/O position (1-4)
PRESET : PRESET the store I/O position (1-4)
NAME : NAME P1 P2 the stored port P1(1-4) no more than 8 characters P2 ,Sst PRESET NAME
I1-I4 : SET ALL OUTPUTS SOURCE
ST : SHOW UNIT FIRMWARE VERSION
RS : System Reset to A1,B2,C3,D4
EM : Setting EDID MODE. EM P1 P2. P1=(1-4 PORT) P2=(1-FHD2CH,2-FHD3CH,3-4KUHD2CH,4-4KUHD3CH,5-4KUHD+2CH,6-4KUHD+MCH,7-TXA,8-TXB,9-TXC,10-TXD,11-USER1,12-USER2,13-USER3,14-USER4)
EM? : Show current EDID mode. EM? P1. P1=(1-4 PORT)
USBESP : Update FW by USB
A1-A4 : SET OUTPUT A SOURCE(1-4)
B1-B4 : SET OUTPUT B SOURCE(1-4)
C1-C4 : SET OUTPUT C SOURCE(1-4)
D1-D4 : SET OUTPUT D SOURCE(1-4)
FADEFAULT : ALL CONFIGURE SET TO FACTORY DEFAULT
AB..1-AB..4 : Switch output ABCD... to 1-4 at the same time
QUIT : Telnet QUIT
```

6.8 WebGUI Control

All primary functions of this unit are controllable via the built in WebGUI. This control is presented across 3 separate tabs, including Switch, EDID Settings, and System Settings. The individual functions will be introduced in the following sections.

To obtain device current IP address, you could use RS232 tool or to install Device Discovery Tool. Use current IP to login WebGUI to functions control

- **Install the Device Discovery Tool**

Please obtain the Device Discovery software from your authorized dealer and save it in a directory where you can easily find it.

Note: The unit's default IP address is 192.168.1.50

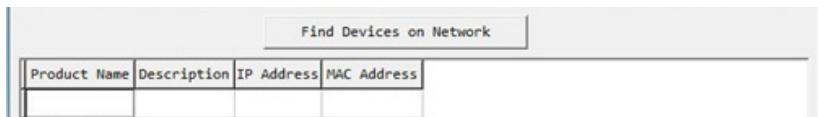

Connect the unit and your PC/Laptop to the same active network and execute the Device Discovery software. Click on “Find Devices on Network” and a list of devices connected to the local network will show up indicating their current IP address.

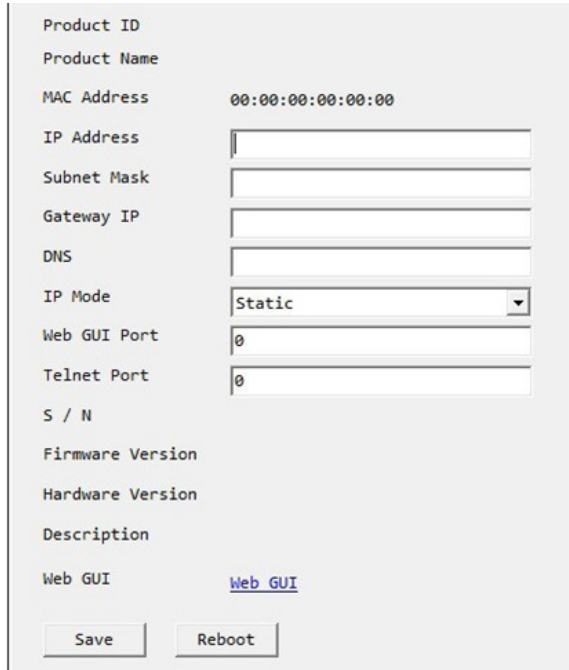

The screenshot shows a web-based configuration interface for a network device. It features a list of fields for network settings, each with a corresponding input field or dropdown menu. The fields are: Product ID, Product Name, MAC Address (displayed as 00:00:00:00:00:00), IP Address, Subnet Mask, Gateway IP, DNS, IP Mode (set to Static), Web GUI Port (set to 0), and Telnet Port (set to 0). Below these fields are sections for S / N, Firmware Version, Hardware Version, and Description. At the bottom, there is a Web GUI link and two buttons: Save and Reboot.

By clicking on one of the listed devices you will be presented with the network details of that particular device. If you choose, you can alter the static IP network settings for the device, or switch the unit into DHCP mode to automatically obtain proper network settings from a local DHCP server. To switch to DHCP mode, please select DHCP from the IP mode drop-down, then click “Save” followed by “Reboot”.

Once you are satisfied with the network settings, you may use them to connect via Telnet or WebGUI. The network information window provides a convenient link to launch the WebGUI directly.

- **Log in to the WebGUI**

To access the WebGUI, open a web browser on a PC/Laptop that is connected to an active network and type the unit's IP address into the web address entry bar. Log into the unit by entering the appropriate user name and password.

Note: The default user name and password are "admin".

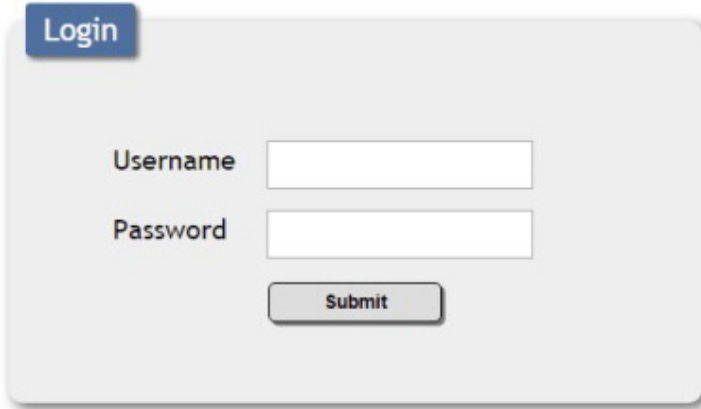

- **Switch Tab**

The Switch tab provides video routing settings, preset saving/loading, and I/O renaming options.

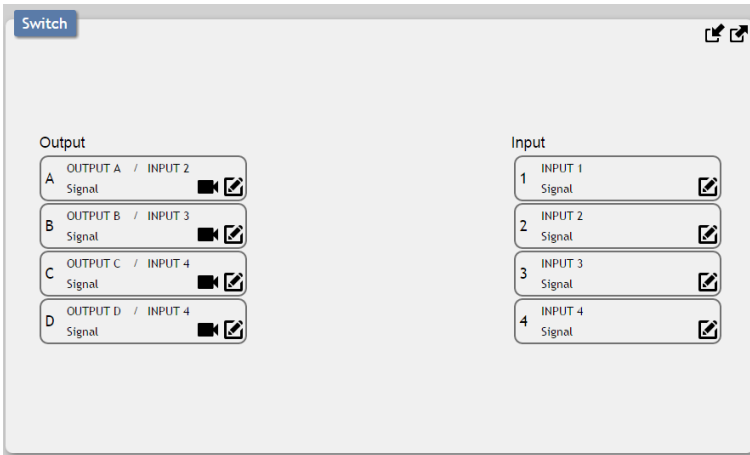

Routing Controls:

To begin assigning a new video route, please click the button of the HDMI output you wish to send video to (e.g. "OUTPUT A") and then click on the button of the preferred HDMI input port (e.g. "INPUT 3"). As you select each button they will change their color to orange. The new route will become active immediately and the routing information displayed on the buttons will change accordingly. If you need to route an input to multiple outputs, please select all of the appropriate output buttons before selecting the input port.

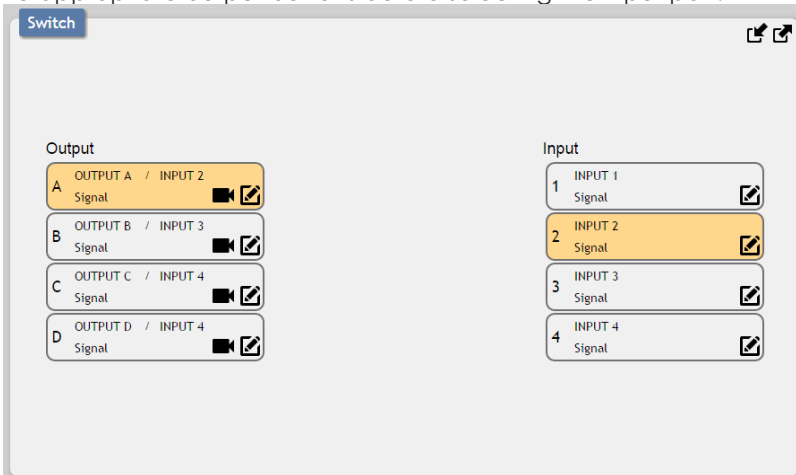

Renaming I/O:

All inputs and outputs can be renamed as required. To rename the HDMI input and output ports please click the "edit" icon (). Click the "Save" icon to confirm the change.

Note: Blank spaces (" ") are not allowed in names.

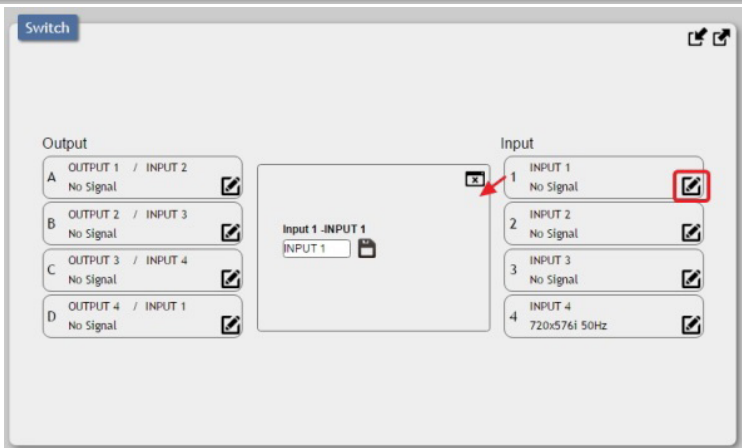
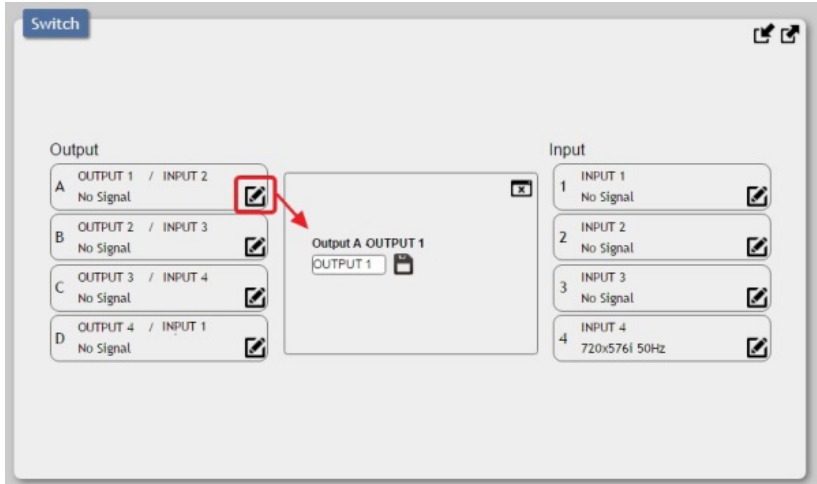

Presets:

This matrix can store up to 4 routing presets. Presets can be utilized to store multiple different routing states in advance for rapid, hassle-free, recall.

➤ **Preset Set:** Once you have the matrix set the way you like, you can click the “store” icon (📁) in the upper right corner of the window. You may also name the preset at this stage by selecting the “edit” icon (✎). Click the preset’s button when you are ready to commit the preset to memory.

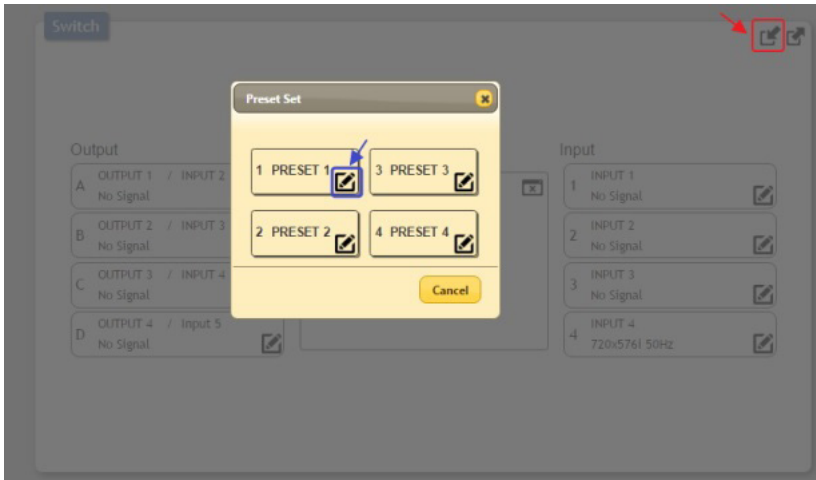

➤ Preset Recall: When you wish to load a previously stored setting, please click the “recall” icon () and you will be presented with a choice of the available 4 presets. The preset will load immediately upon pressing the preset's button.

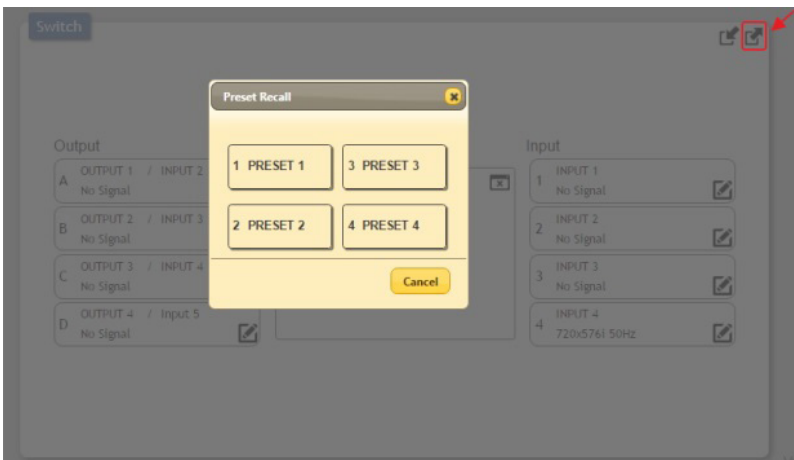

- EDID Settings Tab

This matrix provides the option of six built in EDIDs, four sink sourced EDIDs and four user uploaded EDIDs that can be assigned to each input port individually. The names of the four user uploaded EDIDs can be changed if desired.

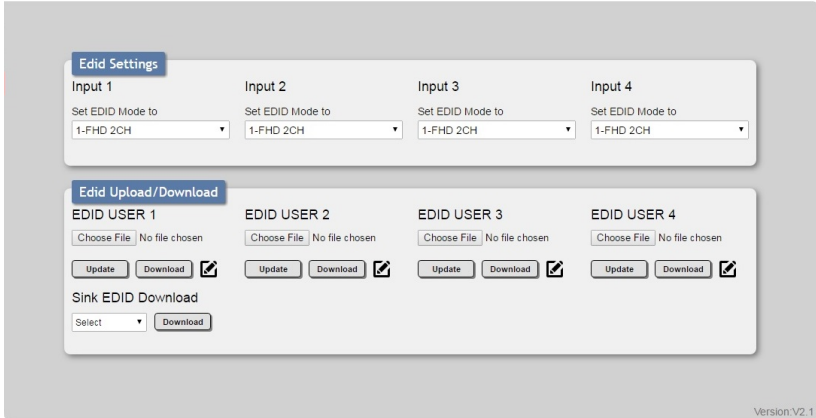

EDID Selection:

The EDID Settings section allows for the assignment of an EDID to each individual input port. Select the preferred EDID from each dropdown menu. The EDID will be changed immediately.

Note: In some rare cases it is possible for custom or external EDIDs to cause compatibility issues with certain sources. If this happens, it is recommended to switch to one of the 6 built in EDIDs for maximum compatibility.

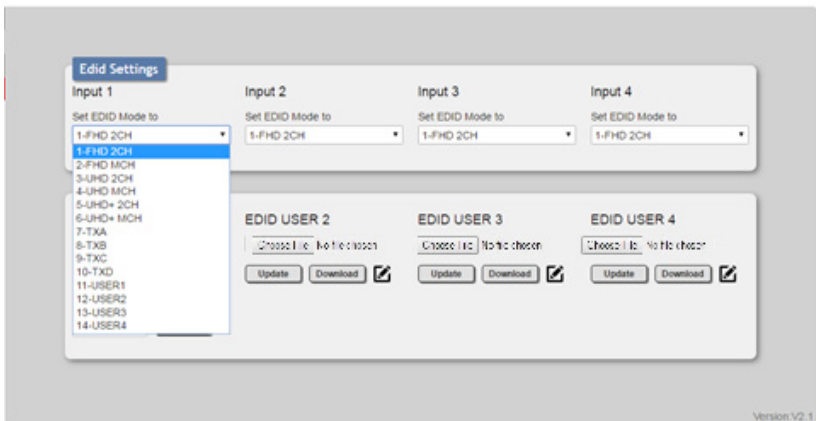

EDID Renaming:

All User EDIDs can be renamed as required. To rename an individual User EDID please click the “edit” icon (✎). Click the “Save” icon to confirm the change.

Note: Blank spaces (“ ”) are not allowed in names.



EDID Upload:

To upload a custom EDID, please click the “Choose File” button below the User EDID that you would like to change. A file selection window will appear, allowing you to locate and upload your preferred EDID file from your local PC. The EDID should be in the *.bin file format. Once the preferred file has been selected, please click the “Update” button, and the file will be transferred to the matrix.

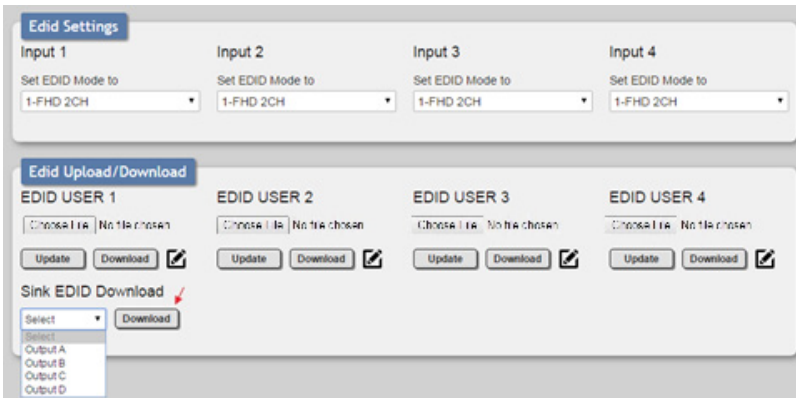

EDID Download:

To save an existing User EDID to your local PC please press the “Download” button next to the User EDID that you would like to save. The EDID will then be saved to your local PC as a *.bin file. To save a copy of the EDID from a connected sink, selected the preferred sink from



the Sink EDID Download dropdown menu and then press the “Download” button next to the selection. The EDID will then be saved to your local PC as a *.bin file.

- **System Settings**

This page provides system configuration options including turning the power on/off, changing the login password, changing the network settings, resetting the system to factory defaults, and updating the firmware.

The screenshot shows the 'System Settings' page with the following elements:

- Power:** A toggle switch set to 'ON'.
- Web User Setting:** Fields for Username, Old Password, New Password, and Confirm Password, with a 'Save' button.
- Web Login Timeout(Minute):** A dropdown menu currently set to '5 min'.
- NetWork:** Fields for IP Mode (DHCP), IP (192.168.5.58), Netmask (255.255.255.0), Gateway (192.168.5.254), and MAC Address (f8-22-85-00-07-43), with a 'Save' button.
- Reset to Default:** Two buttons: 'Routing Reset' and 'Factory Reset'.
- Firmware Upgrade:** A 'Choose File' button (showing 'No file chosen') and an 'Upgrade' button.

Web User Settings:

To change the login password for the unit, enter the username as “admin”, type the current password in the “Old Password” field and then enter the preferred new password in the “New Password” and “Confirm Password” fields. Press “Save” to finalize the change.

Web Login Timeout:

This setting sets the length of idle time to wait before forcing a connected web user to be automatically logged out. Timeout values range from 5 to 60 minutes. To change the this timeout value, select a new value from the dropdown and the change will be enforced immediately.

Network:

The unit's IP mode (DHCP or Static IP), IP address, netmask, and gateway can be set here. When the unit is set to "DHCP" mode, it will automatically attempt to obtain proper configuration information from the local DHCP server. If no DHCP server is available, or the user wishes to configure the network settings manually, please set the unit to "Static IP" mode and enter the information as appropriate for your local network. Press "Save" to activate the changes.

Reset to Default:

To reset all routing settings press the "Routing Reset" button. To reset the entire unit to the factory defaults please press the "Factory Reset" button.

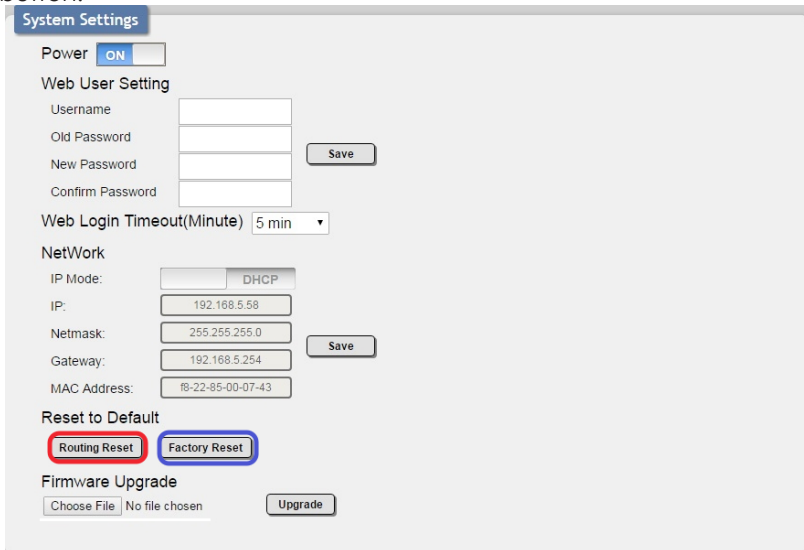

System Settings

Power ON

Web User Setting

Username

Old Password

New Password

Confirm Password

Web Login Timeout(Minute) 5 min ▾

NetWork

IP Mode:

IP:

Netmask:

Gateway:

MAC Address:

Reset to Default

Firmware Upgrade

No file chosen

Firmware Upgrade:

To update the firmware of the unit, press the "Choose File" button to select a new firmware file that is stored on your local PC. After an appropriate file has been selected, press the "Upgrade" button to begin the firmware update process.

7. CONNECTION DIAGRAM

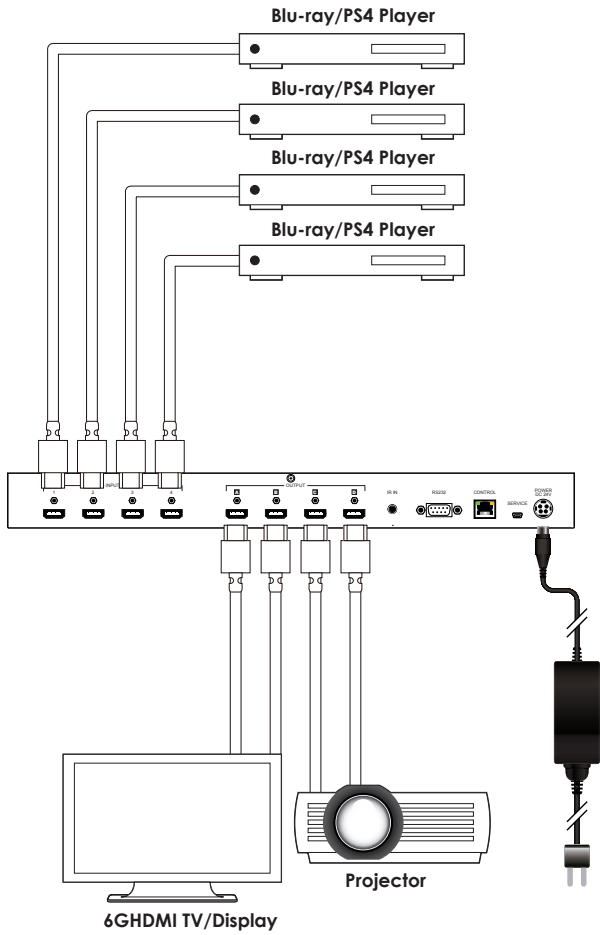

8. SPECIFICATIONS

8.1 Technical Specifications

Video Bandwidth	600MHz/18Gbps
Input Ports	4 x HDMI 1 x IR 1 x RS-232 1 x Mini USB(Service) 1 x RJ45(Control)
Output Ports	4 x HDMI
Supported Resolutions :	480i~1080p@24/50/60Hz 4K up to 4096x2160@60Hz (YUV 4:4:4, 8-bit) VGA~WUXGA
IR Frequency	30~50kHz
Baud Rate	115200 bps
Power Supply	24VDC/2.7A (US/EU standards, CE/FCC/ UL certified)
ESD Protection	Human body model: ±8 kV (air-gap discharge) ±4 kV (contact discharge)
Dimensions	436 mm x 44 mm x 160mm (W×H×D) [Case Only] 436 mm x 48 mm x 167.5mm(W×H×D) [All Inclusive]
Weight	2068g
Chassis Material	Metal
Color	Black
Operating Temperature	0°C~40°C/32°F~104°F
Storage Temperature	-20°C~60°C/-4°F~140°F
Relative Humidity	20~90% RH (non-condensing)
Power Consumption	21W



9. TIMING

DVI and HDMI Supported Resolutions (Hz)	Input	Output
640x480@60/72/75/85	√	√
720x400@85	√	√
800x600@56/60/72/75/85	√	√
1024x768@60/70/75/85	√	√
1152x864@75	√	√
1280x720@60	√	√
1280x768@60/75/85	√	√
1280x800@60	√	√
1280x960@60	√	√
1280x1024@60	√	√
1360x768@60	√	√
1366x768@60	√	√
1400x1050@60	√	√
1440x900@60	√	√
1600x900@60	√	√
1600x1200@60	√	√
1680x1050@60	√	√
1920x1080@60	√	√
1920x1200@60	√	√
1920x1440@60	√	√
2560x1600@60	√	√
1440x576i@50	√	√
1440x480i@59.94/60	√	√
720x480p@59.94/60	√	√
720x576p@50	√	√
1280x720p@50/59.94/60	√	√
1920x1080i@50/59.94/60	√	√

DVI and HDMI Supported Resolutions (Hz)	Input	Output
1920x1080p@23.97/24/25/29.97/30/50/59.94/60	√	√
3840x2160@24/25/30/50/60	√	√
4096x2160@24/25/30/50/60	√	√



CYPRESS TECHNOLOGY CO., LTD
Home page: <http://www.cypress.com.tw>

MPM--CPLUSV4H4H