



CPLUS-V8H8HPA

UHD+ 8x8 Matrix with Audio Output



HDMI[®]
HIGH-DEFINITION MULTIMEDIA INTERFACE

Operation Manual

DISCLAIMERS

The information in this manual has been carefully checked and is believed to be accurate. Cypress Technology assumes no responsibility for any infringements of patents or other rights of third parties which may result from its use.

Cypress Technology assumes no responsibility for any inaccuracies that may be contained in this document. Cypress also makes no commitment to update or to keep current the information contained in this document.

Cypress Technology reserves the right to make improvements to this document and/or product at any time and without notice.

COPYRIGHT NOTICE

No part of this document may be reproduced, transmitted, transcribed, stored in a retrieval system, or any of its part translated into any language or computer file, in any form or by any means—electronic, mechanical, magnetic, optical, chemical, manual, or otherwise—without express written permission and consent from Cypress Technology.

© Copyright 2018 by Cypress Technology.

All Rights Reserved.

TRADEMARK ACKNOWLEDGMENTS

All products or service names mentioned in this document may be trademarks of the companies with which they are associated.





SAFETY PRECAUTIONS

Please read all instructions before attempting to unpack, install or operate this equipment and before connecting the power supply.

Please keep the following in mind as you unpack and install this equipment:

- Always follow basic safety precautions to reduce the risk of fire, electrical shock and injury to persons.
- To prevent fire or shock hazard, do not expose the unit to rain, moisture or install this product near water.
- Never spill liquid of any kind on or into this product.
- Never push an object of any kind into this product through any openings or empty slots in the unit, as you may damage parts inside the unit.
- Do not attach the power supply cabling to building surfaces.
- Use only the supplied power supply unit (PSU). Do not use the PSU if it is damaged.
- Do not allow anything to rest on the power cabling or allow any weight to be placed upon it or any person walk on it.
- To protect the unit from overheating, do not block any vents or openings in the unit housing that provide ventilation and allow for sufficient space for air to circulate around the unit.
- Please completely disconnect the power when the unit is not in use to avoid wasting electricity.

VERSION HISTORY

REV.	DATE	SUMMARY OF CHANGE
RDV1	2019/08/12	Preliminary release



CONTENTS

1. Introduction	1
2. Applications	1
3. Package Contents	1
4. System Requirements	2
5. Features	2
6. Operation Controls and Functions	3
6.1 Front Panel.....	3
6.2 Rear Panel.....	5
6.3 Remote Control.....	6
6.4 IR Cable Pinouts	7
6.5 RS-232 Pinout and Defaults	7
6.6 Front Panel LCD Menu.....	8
6.7 WebGUI Control.....	14
6.7.1 Video Switch Tab	16
6.7.2 EDID Settings Tab	20
6.7.3 Device Settings Tab	22
6.7.4 User Config Tab	23
6.7.5 System Settings Tab	24
6.8 Telnet Control	25
6.9 Serial and Telnet Commands	26
7. Connection Diagram	41
8. Specifications	42
8.1 Technical Specifications	42
8.2 Video Specifications.....	43
8.3 Audio Specifications	44
8.3.1 Digital Audio	44
8.3.2 Analog Audio	45
8.4 Cable Specifications	45
9. Acronyms	46





1. INTRODUCTION

This 4K UHD⁺ 8x8 HDMI Matrix provides the ability to connect up to eight 4K UHD⁺ HDMI sources to up to eight 4K UHD⁺ HDMI displays and freely switch between them. This unit comes with full support for 18Gbps resolutions up to, and including 4K@60Hz (4:4:4, 8-bit) as well as support for 16-bit Deep Color, HDR (High Dynamic Range), HD audio and other features defined by the HDMI 2.0 specification. Additionally, eight analog stereo audio outputs are paired with each HDMI output to provide breakout audio support when needed. With a comprehensive EDID management feature that includes the ability to select between built in EDIDs, EDIDs copied from connected sink devices, as well as user provided EDIDs, this matrix can solve many interconnectivity problems.

The unit's OSD has the ability to display up to 2 lines of user customized text, on top of the video displayed over each output, in the color of your choice. This unit provides an intuitive set of front panel controls with an OSD as well as RS-232, Telnet, WebGUI, and IR remote control options.

2. APPLICATIONS

- Smart Home Control
- Control Center
- Function Room
- Product Showroom
- Ballroom

3. PACKAGE CONTENTS

- 1xUHD⁺ 8x8 Matrix with Audio Output
- 1x24V/3.75A DC Power Adapter
- 1xRemote Control (CR-177)
- 1xRackmount Ears (Set of 2)
- 1xShockproof Feet (Set of 4)
- 1xOperation Manual

4. SYSTEM REQUIREMENTS

- HDMI source equipment such as media players, video game consoles or set-top boxes.
- HDMI receiving equipment such as HDTVs, monitors or audio amplifiers.
- The use of Premium High Speed HDMI cables is highly recommended.

5. FEATURES

- HDMI inputs and outputs support 18Gbps 4K UHD⁺ with HDR signals
- DVI 1.0 compliant with the use of an HDMI to DVI adapter
- HDCP 1.x and 2.2 compliant
- HDMI inputs and outputs support UHD⁺ resolutions up to 4096×2160@60Hz (4:4:4, 8-bit)
- Supports 16-bit Deep Color up to 1080p60
- Supports pass-through of LPCM (up to 8 channels), bitstream and HD bitstream audio formats
- High-quality DAC (Digital to Analog audio Conversion) with local analog stereo audio breakout for each HDMI output (LPCM 2.0 sources only)
- Supports six internal EDIDs, eight external EDIDs copied from connected devices, and eight user provided EDIDs
- OSD with user customizable information text
- Controllable via front-panel buttons with LCD, WebGUI, Telnet, RS-232, and IR remote

6. OPERATION CONTROLS AND FUNCTIONS

6.1 Front Panel

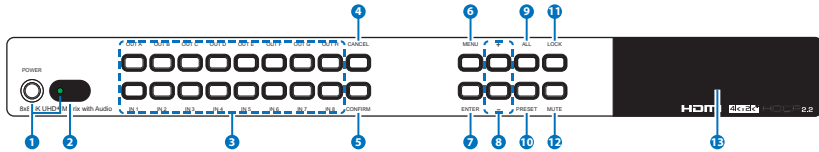

- 1 **POWER Button:** Press this button to power the unit on (green LED) or place it into stand-by mode (red LED).
- 2 **IR Window:** Accepts IR signals from the included IR remote for control of this unit only.
- 3 **IN 1~8 & OUT A~H Buttons:** Press these buttons to configure the video routing. Selection behavior depends on the current Keypad Action Mode.
 - 3a **In Standard Mode:** Press the “OUT” buttons (A~H) of the outputs you wish to route a source to (the letters will flash in the LCD to indicate selection). Next, press the “IN” button of the input (1~8) you wish to route to the selected outputs. Finally, press “CONFIRM” to confirm your selection and execute the routing change.
 - 3b **In User Mode:** Press the “OUT” button (A~H) of an output you wish to route a source to (the letter will flash in the LCD to indicate selection). Next, press the “IN” button of the input (1~8) you wish to route to the selected output. Repeat this process as many times as needed to select all new routes. Finally, press “CONFIRM” to confirm your selections and execute the routing changes.
- 4 **CONFIRM Button:** Press this button to confirm newly made input/output routing selections.
- 5 **CANCEL Button:** Press this button to cancel newly made input/output/preset routing selections before they have been confirmed.
- 6 **MENU Button:** Press to enter the LCD menu, or to back out from menu items.

- 7 ENTER Button:** Press to confirm a selection within the LCD menu or to go deeper into a menu item.
- 8 + (PLUS) & - (MINUS) Buttons:** Press to move up and down or adjust selections within the LCD menu.
- 9 ALL Button:** Press this button to select all outputs simultaneously for routing. Next, press the "IN" key of the input (1~4) you wish to route to all outputs. Finally, press "CONFIRM" to confirm your selection and execute the routing change.
- 10 PRESET Button:** Press to enter the preset recall menu in the LCD window. Press the "+/-" buttons followed by the "ENTER" button to select and activate the preferred preset.
- 11 LOCK Button:** Press to lock all button functions on the front panel. Press and hold for 3 seconds to release the lock function. The LCD will display "Lock" when the function is active.
- 12 MUTE Button:** The "MUTE" button functions as a blank audio/video source. To use it, follow the standard matrix routing instructions, but use the "MUTE" button as the input to blank out the selected outputs. When a "MUTE" input is in use it will show up as "M" within the routing display.
- 13 LCD Window:** Displays the unit's menu, settings and information.

6.2 Rear Panel

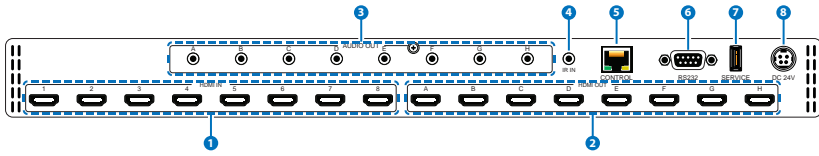

- 1 HDMI IN 1~8 Ports:** Connect to HDMI source equipment such as media players, game consoles or set-top boxes.
- 2 HDMI OUT A~H Ports:** Connect to HDMI TVs, monitors, or amplifiers for digital video and audio output.
- 3 AUDIO OUT A~D Ports:** Connect to powered speakers or an amplifier for analog stereo audio output. The audio from each stereo analog output will be the same as the HDMI output it is paired with.

Note: Supports LPCM 2.0 audio sources only.
- 4 IR IN Port:** Connect to the provided IR Extender to extend the IR control range of the unit. Ensure that the remote being used is within direct line-of-sight of the IR Extender.
- 5 CONTROL Port:** Connect directly, or through a network switch, to your PC/laptop to control the unit via Telnet/WebGUI.
- 6 RS232 Port:** Connect directly to a PC, laptop or other serial control device to send RS-232 commands to control the unit.
- 7 SERVICE Port:** This slot is reserved for firmware update use only.
- 8 DC 24V Port:** Plug the 24V DC power adapter into the unit and connect it to an AC wall outlet for power.

6.3 Remote Control

- 1 **POWER Button:** Press to power the unit on or place it into stand-by mode.
- 2 **1/A ~ 8/H Buttons:** Press these keys to configure the video routing. Selection behavior depends on the current Keypad Action Mode.
- 2a **In Standard Mode:** Press the "OUT" key followed by the key (A-H) of the output you wish to route to. Next, press the "IN" key followed by the input (1-8) you wish to route to the selected output. Repeat this process as many times as needed. Finally, press "ENTER" to confirm your selection.
- 2b **In User Mode:** Press the "OUT" key followed by the key (A-H) of the output you wish to route to. Next, press the "IN" key followed by the input (1-8) you wish to route to the selected output. Repeat this process as many times as needed. Finally, press "ENTER" to confirm your selection.
- 3 **ALL Button:** Press this key to select all outputs simultaneously for routing. Next, press the key of the input (1-8) you wish to route to all outputs. Finally, press "ENTER" to confirm your selection and execute the routing change.
- 3a **MUTE Button:** Press this key to mute video output. Press the key of the input (1-8) you wish to route then press mute key to mute video output.
- 3b **INFO Button:** Switches the information displayed on each output's OSD between the user customized text and the current video/Ethernet details.
- 3c **PRESET Button:** Press to enter the preset call menu in the LCD window. Press the "+/IN" and "-/OUT" buttons followed by the "ENTER" button to select and activate the preferred preset.
- 4 **MENU Button:** Press to enter the LCD menu, or to back out from menu items.
- 4a **ENTER Button:** Press to confirm a selection within the LCD menu or to go deeper into a menu item.
- 4b **CANCEL Button:** Press to cancel newly made input/output/preset routing selections before they have been confirmed.
- 4c **+ (PLUS)/IN Button:** Press to navigate up within menus or to begin the selection of an input for routing.
- 4d **- (MINUS)/OUT Button:** Press to navigate down within menus or to begin the selection of outputs for routing.

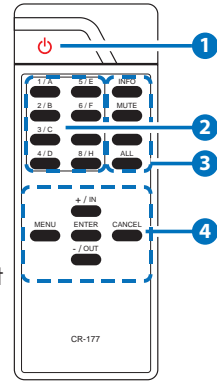

6.4 IR Cable Pinouts

IR Extender Cable

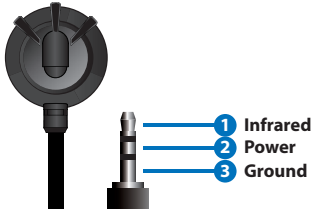

6.5 RS-232 Pinout and Defaults

Serial Port Default Settings	
Baud Rate	19200
Data Bits	8
Parity Bits	None
Stop Bits	1
Flow Control	None

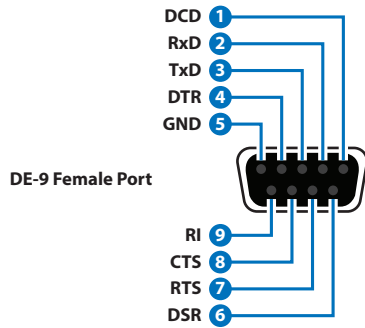

6.6 Front Panel LCD Menu

All primary functions of this unit can be controlled by using the front panel LCD menu which is activated by pressing the MENU button on the front of the unit. Use the + (PLUS), - (MINUS), and ENTER buttons to navigate the LCD menu. Press the MENU button to back out from any menu item and then press it again to close the menu.

MAIN MENU
Video Setup
Drivers Setup
System Setup
Network Status
Network Setup

The individual functions of the LCD menu will be introduced in the following section. Items marked in **BOLD** are the factory default settings.

VIDEO SETUP				
2ND LEVEL	3RD LEVEL	4TH LEVEL	5TH LEVEL	
EDID Setup	EDID Mode	ALL MODE		
		Appoint Mode		
	Appoint Mode EDID	IN1 ~ IN8	FHD 2CH	
			FHD MCh	
			UHD 2Ch	
			UHD MCh	
			UHD+ 2Ch	
			UHD+ MCh	
			User 1~8	
			Sink A~H	
	All Mode EDID		FHD 2CH	
			FHD MCh	
			UHD 2Ch	
			UHD MCh	
			UHD+ 2Ch	
UHD+ MCh				
User 1~8				
Sink A~H				
Preset Setup	1 ~ 8			
Downscale Setup	A ~ H	N (OFF)		
		Y (On)		

1) **EDID Setup:** Provides a variety of ways to set the EDID(s) used by the inputs on the unit.

- **EDID Mode:** Selects the EDID assignment mode used by the unit. Selecting "All Mode" will assign a single EDID to be used by all inputs. Selecting "Appoint Mode" allows the assignment of a different EDID to each input.

Note: In most cases, changing the EDID mode will cause all inputs to briefly blink out while the source adapts to the new information.

- **Appoint Mode EDID:** Select the EDID to be used by each input when Appoint Mode is active.
 - **All Mode EDID:** Select the EDID to be used by all inputs when All Mode is active.
- 2) **Preset Setup:** Use the “+”/“-”keys to select a preset number then press the “Enter” key to store the current routing state in that preset.
 - 3) **Downscale Setup:** Enables or disables the 4K to 1080p downscaling functionality of each output. Press the front panel button associated with each output to toggle the setting and then press the “Enter” key to confirm it. When this setting is turned on, 4K sources will be automatically downscaled to 1080p while maintaining the original framerate.

DRIVERS SETUP	
2ND LEVEL	3RD LEVEL
Temperature	[Info Display]
Fan Ctrl	ALWAYS ON MODE
	Auto Mode
IR Discrete	[Info Display]

- 1) **Temperature:** Provides information about the unit’s current internal temperature.
- 2) **Fan Ctrl:** Controls the behavior of the internal fan. Selecting “Auto Mode” will only activate the fan when the internal temperature exceeds a safe level.
- 3) **IR Discrete:** Displays the current Discrete IR code prefix.

Note: This code is configured within the WebGUI

SYSTEM SETUP		
2ND LEVEL	3RD LEVEL	4TH LEVEL
Firmware	[Info Display]	
Firmware Update	Do USB Update?	NO
		Yes
Factory Reset	Do Factory Reset?	NO
		Yes
Keypad Action Mode	STANDARD MODE	
	User Mode	
Show Timing Info	A ~ H	Y (SHOW)
		N (Don't Show)

- 1) **Firmware:** Displays the unit's current firmware version.
- 2) **Firmware Update:** Provides a way to update the unit's firmware. To begin a firmware update, select "Yes" and then insert a USB thumb drive, with a valid firmware file (*.bin format) in the root directory, into the unit's USB service port. After the update is complete the unit will automatically reboot.
- 3) **Factory Reset:** Selecting YES will reset the unit's settings back to their factory defaults.
Note: The unit will automatically reboot after the factory reset is complete.
- 4) **Keypad Action Mode:** Provides a way to switch between the "Standard" (single input routing selection) and "User" (multiple output routing selection) keypad action modes.
- 5) **Show Timing Info:** Enables or disables the display of resolution timing information on the OSD whenever the source's timing changes. Press the front panel button associated with each output to toggle the setting and then press the "Enter" key to confirm it.

NETWORK STATUS	
2ND LEVEL	3RD LEVEL
Link:	[Current link status]
Mode:	[Current network mode]
IP:	[Current IP address]
Mask:	[Current netmask]
Gate:	[Current gateway address]
MAC:	[MAC address]

- 1) **Network Status:** Displays the unit's current networking information or status for each item.

NETWORK SETUP	
2ND LEVEL	3RD LEVEL
Mode	STATIC
	DHCP
IP:	[Editable static IP address]
Mask:	[Editable netmask]
Gate:	[Editable gateway address]

- 1) **Mode:** Set the unit to Static or DHCP mode. When DHCP mode is selected, all IP address information will be assigned automatically by the local DHCP server. When Static is selected, the IP address, netmask and gateway must be set manually and additional menu items become available.
- 2) **IP:** When DHCP is off, the IP address can be set here. Press the "Enter" button to begin editing the address and use the "+" and "-" buttons to adjust each value. Press the "Enter" button to store the current number segment and move to the next segment.
Note: The unit's default static IP address is 192.168.1.50.
- 3) **Mask:** When DHCP is off, the netmask can be set here. Press the "Enter" button to begin editing the address and use the "+" and "-" buttons to adjust each value. Press the "Enter" button to store the current number segment and move to the next segment.



- 4) **Gate:** When DHCP is off, the gateway address can be set here. Press the "Enter" button to begin editing the address and use the "+" and "-" buttons to adjust each value. Press the "Enter" button to store the current number segment and move to the next segment.

6.7 WebGUI Control

- **Device Discovery**

Please obtain the “Device Discovery” software from your authorized dealer and save it in a directory where you can easily find it.

Connect the unit and your PC/Laptop to the same active network and execute the “Device Discovery” software. Click on “Find Devices on Network” and a list of devices connected to the local network will show up indicating their current IP address.

Note: The unit’s default IP address is 192.168.1.50.



Product Name	Description	IP Address	MAC Address

By clicking on one of the listed devices you will be presented with the network details of that particular device.

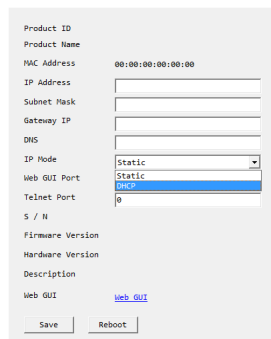

Product ID
Product Name
MAC Address 00:00:00:00:00:00
IP Address
Subnet Mask
Gateway IP
DNS
IP Mode Static
Web GUI Port
Telnet Port 0
S / N
Firmware Version
Hardware Version
Description
Web GUI [Web GUI](#)
Save Reboot

- 1) **IP Mode:** If you choose, you can alter the static IP network settings for the device, or switch the unit into DHCP mode to automatically obtain proper network settings from a local DHCP server. To switch to DHCP mode, please select DHCP from the IP mode drop-down, then click “Save” followed by “Reboot”.
- 2) **WebGUI Hotkey:** Once you are satisfied with the network settings, you may use them to connect via Telnet or WebGUI. The network information window provides a convenient link to launch the WebGUI directly.

- **WebGUI Overview**

After connecting to the WebGUI's address in a web browser, the login screen will appear. Please enter the appropriate user name and password then click "Submit" to log in.

Note: The default user name and password is "admin".

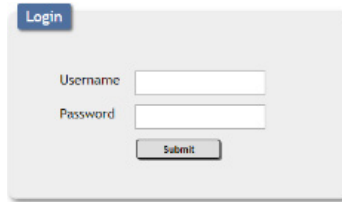

A login form with a blue "Login" button at the top left. Below it are two input fields: "Username" and "Password". At the bottom center is a "Submit" button.

On the left side of the browser you will see the following menu tabs where all primary functions of the unit are controllable via the built in WebGUI. The individual functions will be introduced in the following sections.

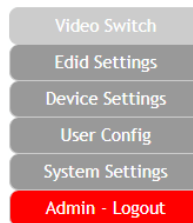

Clicking the red "Logout" tab will automatically log the currently connected user out of the WebGUI and return to login page.

6.7.1 Video Switch Tab

This page provides video routing settings, preset saving/loading, and I/O renaming options. To begin assigning a new video route, please click the button of the HDMI output you wish to send video to and then click on the button of the preferred HDMI input port. If desired, you may select more than one output prior to selecting the input. As you select each button they will change their color to orange. The new route will become active immediately after selecting the input port and the routing information displayed on the buttons will change accordingly.

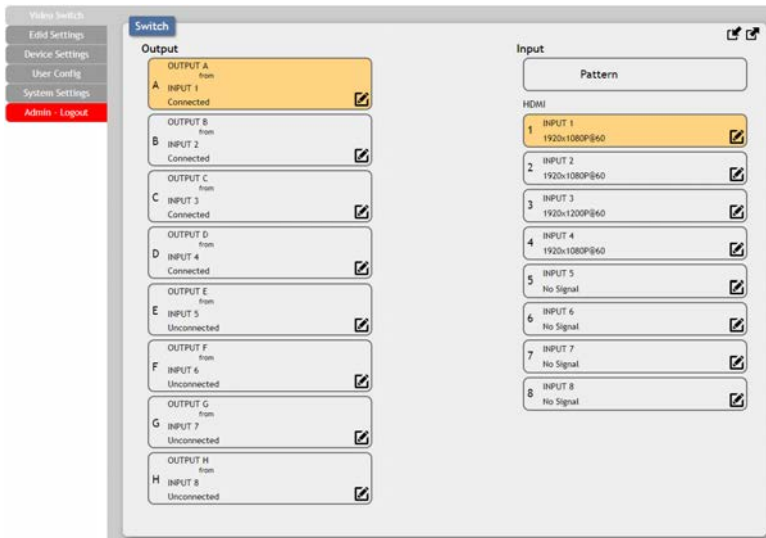

- 1) **Output:** Buttons for selecting the output (A-H) to route A/V Inputs to. Details about the output names and currently selected Input are also displayed here.
- 2) **Input:** Buttons for selecting the input to route to the selected output(s). Detail about the input names and signal information is also displayed here.

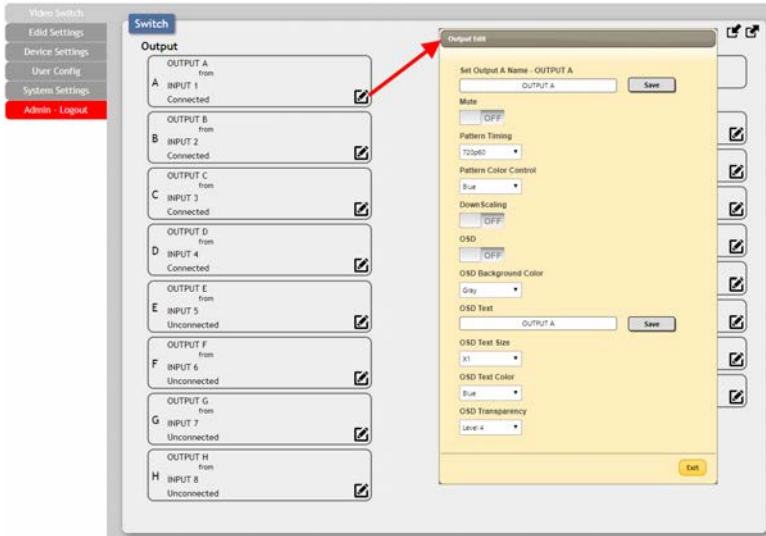

3) **Output Edit:** A variety of output settings, including name, muting, test pattern configuration, downscaling, and OSD options can be configured here. Please click the “Edit” icon (✎) within the Output button to open up the Output Edit window.

- **Set Output Name:** To rename the output port, type the new name in the space provided in the Edit window. Click the “Save” button to confirm the change.
Note: Blank spaces (“ ”) are not allowed in names.
- **Mute:** Each output can be individually muted (black video, no audio). To mute an output, please click on the switch so it reads “ON”.
- **Pattern Timing:** This setting configures the output resolution used when “Pattern” has been selected as the input source. The following resolutions are supported: 4K@25/30/50/60Hz, 1080P@50/60Hz and 720P@50/60.
- **Pattern Color Control:** This setting configures the contents of the test pattern when “Pattern” is selected as the input source. Available patterns are: black, blue, green, cyan, red magenta, yellow, white, and color bars.

- **Downscaling:** This switch enables or disables the downscaling functionality of the output. When this setting is turned on, 4K sources will be automatically downscaled to 1080p while maintaining the original framerate.
- **OSD:** This switch enables or disables the custom text display for this output. When enabled, the OSD text will be displayed in the upper-left corner of the selected output.
- **OSD Background Color:** Use the dropdown to select the preferred background color for the OSD custom text. Available colors are: black, white, red, green, blue, magenta, yellow, cyan, and gray.
- **OSD Text:** Each output can display up to 2 lines of customized OSD text. Enter the text here. Click the “Save” button to confirm changes.

Note: Each line of text can have up to 64 characters, after 64 characters the text automatically wraps to the next line.

- **OSD Text Size:** Use the dropdown to select the preferred size for the OSD custom text. Available sizes are: 1x, 2x, and 4x.
- **OSD Text Color:** Use the dropdown to select the preferred color for the OSD custom text. Available colors are: black, white, red, green, blue, magenta, yellow, cyan, and gray.
- **OSD Transparency:** Use the dropdown to select the preferred transparency level of the OSD custom text’s background. The available range is from Level 1 (fully opaque) to Level 8 (fully transparent).

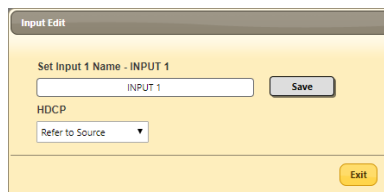

- 4) **Input Edit:** Each input allows for Individual control over the name of the input and the behavior of HDCP. To edit the settings of an input port please click the “Edit” icon (🔗) within the appropriate button.

- **Set Input Name:** To rename the input port, type the new name in the space provided in the Edit window. Click the “Save” button to confirm the change.
Note: Blank spaces (“ ”) are not allowed in names.
- **HDCP:** Provides control over the HDCP behavior of each HDMI input.
 - HDCP Support Off: Completely disables support for HDCP on that input.
 - Refer to Source: Makes the input port support the same HDCP version as required by the connected source.
 - Refer to Display: Makes the input support the HDCP version of the currently routed display.

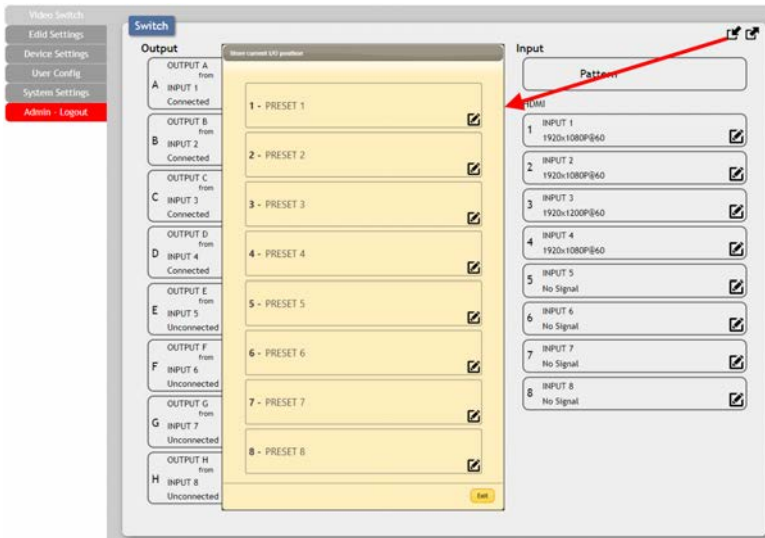

5) **Preset Settings:** This matrix can store up to eight video routing presets. Presets can be utilized to store multiple different routing states in advance for rapid, hassle-free, recall.

- **Store Preset:** Once you have the matrix set the way you like, you can click the “Store” icon (📌) in the upper right corner of the window and the Store Current I/O Position window will open. Hovering the mouse over each button will display the current routing stored within it. You may also name the preset

at this stage by selecting the “Edit” icon (✎). Click the center of the preset’s button to store the current routing state in that preset.

- **Recall Preset:** When you wish to load a previously stored preset, please click the “Recall” icon (↶) and you will be presented with a choice of the 8 available presets. Hovering the mouse over each button will display the routing stored within it. The preset will load immediately upon clicking the button.

6.7.2 EDID Settings Tab

This matrix provides the option of six standard EDIDs, eight sink sourced EDIDs and eight user uploaded EDIDs that can be assigned to each input port individually. The names of the eight user uploaded EDIDs can be changed if desired.

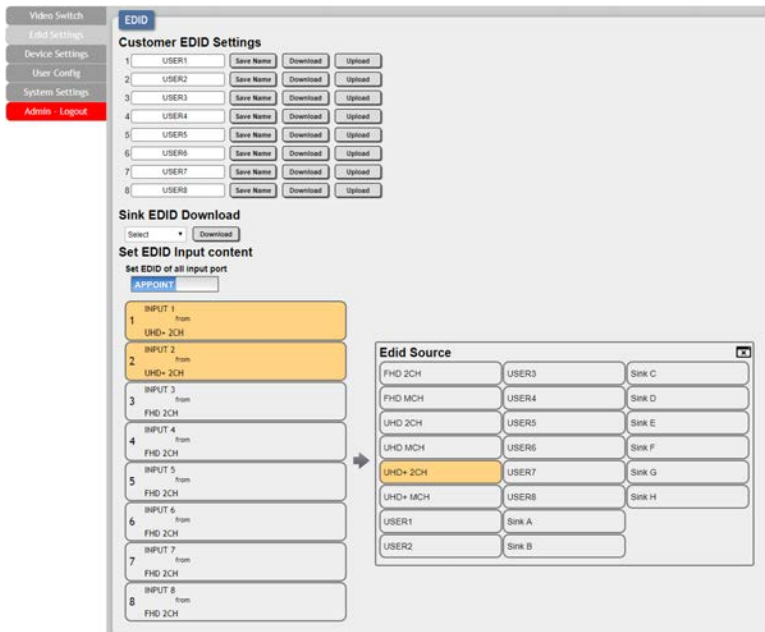

1) Customer EDID Settings:

- **Save Name:** To change the name of a Customer EDID, type the new name in the space provided, then click on the “Save Name” button.

- **Download:** To save an existing user EDID to your local PC please press the “Download” button next to the EDID you would like to save. Depending on your browser settings you will either be asked where to save the downloaded file, or the file will be transferred directly to the default download location on your PC.
 - **Upload:** To upload a new user EDID, please click the “Upload” button next to the Customer EDID Settings item you would like to change. An EDID Upload window will appear, allowing you to locate and upload the preferred EDID file (*.bin format) from a local PC. Once the correct file has been selected, please click the “Upload” button in the window, and the file will be transferred to the matrix.
- 2) **Sink EDID Download:** To save the EDID from one of the connected displays to your local PC, select the appropriate sink from the dropdown list then press the “Download” button. Depending on your browser settings you will either be asked where to save the downloaded file, or the file will be transferred directly to the default download location on your PC.
- 3) **Set EDID Input Content:** This section provides controls for assigning EDID to the matrix’s inputs. Selecting “Appoint” allows for different EDID to be assigned to each individual input, selecting “ALL” allows for a single EDID to be assigned to all inputs.
- **EDID Source:** Click on the preferred input(s) to open the EDID Source management window. Multiple inputs can be selected at once, if desired. Select the new EDID source to use and the change will occur immediately.

Note: In most cases, assigning a new EDID to an input will cause the affected input to briefly blink out while the source adapts to the new information.

This matrix provides the following 6 default EDIDs:

Unit's Default EDIDs	
FHD/2CH	1920×1080p@60Hz (4.95Gbps) & 8-bit color, LPCM 2.0
FHD/MCH	1920×1080p@60Hz (4.95Gbps) & 8-bit color, LPCM 7.1 & Bitstream
UHD/2CH	3840×2160p@30Hz (10.2Gbps) & Deep Color (8/10/12-bit), LPCM 2.0
UHD/MCH	3840×2160p@30Hz (10.2Gbps) & Deep Color (8/10/12-bit), LPCM 7.1 & Bitstream
UHD+/2CH	3840×2160p@60Hz (18Gbps) & Deep Color (8/10/12-bit), LPCM 2.0
UHD+/MCH	3840×2160p@60Hz (18Gbps) & Deep Color (8/10/12-bit), LPCM 7.1 & Bitstream

Note: In some rare cases it is possible for custom or external EDIDs to cause compatibility issues with certain sources. If this happens, it is recommended to switch to one of the 6 default EDIDs for maximum compatibility.

6.7.3 Device Settings Tab

This page provides control over the matrix's hardware related settings and options including IR settings and fan control.



- 1) **IR Channel:** Use the dropdown to select the IR channel used to control the matrix using the included remote. If this setting is changed, the dipswitches inside the remote control's battery compartment must also be changed to match.

Note: By default both the remote and the unit are set to channel 15.

- 2) **IR Discrete Custom Code:** Allows setting the discrete IR code prefix, primarily for use with learning remotes, to control the functions of this matrix.

Note: To obtain a complete list of IR control codes please contact your authorized dealer.

- 3) **Temperature & Fan Settings:** Provides information about the unit’s current temperature and the speed of both internal fans. The fan mode can be switched between “Always On” and “Auto”. By default, the fan control is set to “Always On”.

6.7.4 User Config Tab

This tab provides User Configuration options including changing the password for the Administrator account, and both the user name and password for the General User account.



Note: The General User account has limited access to the WebGUI and can only change video routing, store/recall presets, and modify the General User’s own account settings.

6.7.5 System Settings Tab

This tab provides system information, power control, Ethernet configuration options, system configuration backup/restore, and firmware update functions.

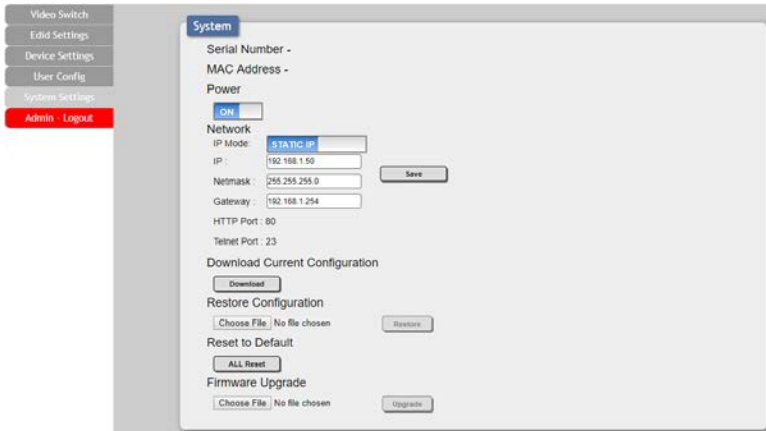

- 1) **Power:** Press this switch to toggle the unit's power between ON and OFF (standby mode).
Note: While in standby mode the unit's WebGUI, Telnet and RS-232 controls are still active.
- 2) **Network:** The unit's IP mode may be switched between Static IP or DHCP. In Static IP mode the IP, netmask and gateway addresses may be manually set. When in DHCP mode, the unit will attempt to connect to a local DHCP server and obtain IP, netmask and gateway addresses automatically. Press "Save" after making any changes to the IP configuration or mode.
Note: The unit's default IP address is 192.168.1.50. If the IP address is changed then the IP address required for WebGUI/Telnet access will also change accordingly.
- 3) **Download Current Configuration:** The current system configuration, including routing and presets, may be saved as an XML file to a PC. Click the "Download" button to save the current system configuration to your local PC.
- 4) **Restore Configuration:** Previously saved system configurations may be restored from a saved XML file. Click the "Choose File" button



to locate the saved XML file, then click the “Restore” button.

- 5) **Reset to Default:** Press this button to reset the unit to its factory default state. After the reset is complete, the unit will reboot automatically.
- 6) **Firmware Upgrade:** To update the unit’s firmware, click the “Choose File” button to open the file selection window and then select the firmware update file (*.bin format) located on your local PC. After selecting the file, click the “Upgrade” button to begin the firmware update process.

6.8 Telnet Control

Before attempting to use Telnet control, please ensure that both the unit and the PC are connected to the same active networks.

To Access the Command Line Interface (CLI)	
Windows 7	Click Start , type “cmd” in the search field, and press Enter .
Windows XP	Click Start > Run , type “cmd”, and press Enter .
Mac OS X	Click Go > Applications > Utilities > Terminal .

Once in the Command Line Interface (CLI) type “**telnet**” followed by the IP address of the unit (and the port number if it is non-standard) and then hit “**Enter**”. This will connect us to the unit we wish to control.

```
Microsoft Windows [Version 6.1.7601]
Copyright (c) 2009 Microsoft Corporation. All rights reserved.

C:\Users\Administrator>telnet 192.168.1.50 23
```

Note 1: If the IP address is changed then the IP address required for Telnet access will also change accordingly.

Note 2: The default IP address is 192.168.1.50.

6.9 Serial and Telnet Commands

COMMAND												
Description and Parameters												
General & System Commands												
<p>HELP↵</p> <p>Show the full command list.</p>												
<p>?↵</p> <p>Show the full command list.</p>												
<p>SET FACTORY DEFAULT↵</p> <p>Reset the unit to the factory defaults.</p>												
<p>SET FACTORY IPCONFIG DEFAULT↵</p> <p>Reset the unit's network settings to the factory defaults.</p>												
<p>SET FACTORY OUT ROUTE DEFAULT↵</p> <p>Reset the unit's routing to the factory defaults.</p>												
<p>SET POWER N1↵</p> <p>Turn the unit on or place it into stand-by mode.</p> <p>Available values for N1:</p> <table style="width: 100%; border: none;"> <tr> <td style="width: 50%;">ON</td> <td>[Power On]</td> </tr> <tr> <td>STANDBY</td> <td>[Standby Mode]</td> </tr> </table>	ON	[Power On]	STANDBY	[Standby Mode]								
ON	[Power On]											
STANDBY	[Standby Mode]											
<p>GET POWER↵</p> <p>Show the unit's current power state.</p>												
<p>SET UART 1 BAUDRATE N1↵</p> <p>Set the baud rate of the RS-232 port.</p> <p>Available values for N1:</p> <table style="width: 100%; border: none;"> <tr> <td style="width: 50%;">4800</td> <td>[4800 baud]</td> </tr> <tr> <td>9600</td> <td>[9600 baud]</td> </tr> <tr> <td>19200</td> <td>[19200 baud]</td> </tr> <tr> <td>38400</td> <td>[38400 baud]</td> </tr> <tr> <td>57600</td> <td>[57600 baud]</td> </tr> <tr> <td>115200</td> <td>[115200 baud]</td> </tr> </table>	4800	[4800 baud]	9600	[9600 baud]	19200	[19200 baud]	38400	[38400 baud]	57600	[57600 baud]	115200	[115200 baud]
4800	[4800 baud]											
9600	[9600 baud]											
19200	[19200 baud]											
38400	[38400 baud]											
57600	[57600 baud]											
115200	[115200 baud]											

COMMAND	
Description and Parameters	
GET UART 1 BAUDRATE↵	Show the current baud rate of the RS-232 port.
SET IR IN CHANNEL N1↵	Set the channel for the IR input to use. N1 = 0~15 [IR Channel]
GET IR IN CHANNEL↵	Show the current channel used by the IR input.
SET IR IN CUSTOM CODE N1↵	Set the custom code used by the IR input. N1 = 0000~7FFF [IR custom code in ASCII hex]
GET IR IN CUSTOM CODE↵	Show the current custom code used by the IR input.
SET FAN CONTROL MODE N1↵	Set the fan control mode. Available values for N1 : 0 [Always On] 1 [Auto]
GET FAN CONTROL MODE↵	Show the current fan control mode.
GET FAN N1 SPEED↵	Show the current rotation speed of the specified fan. N1 = 1~2 [Fan ID number]
GET DEVICE TEMPERATURE↵	Show the unit's current temperature.

COMMAND							
Description and Parameters							
SET KEYLOCK N1↵	<p>Enable or disable the front panel key lock.</p> <p>Available values for N1:</p> <table> <tr> <td>ON</td> <td>[Locked]</td> </tr> <tr> <td>OFF</td> <td>[Unlocked]</td> </tr> </table>	ON	[Locked]	OFF	[Unlocked]		
ON	[Locked]						
OFF	[Unlocked]						
GET KEYLOCK↵	<p>Show the current front panel lock state.</p>						
GET FW VER↵	<p>Show the unit's current firmware version.</p>						
SET OUT N1 OSD INFO DISPLAY N2↵	<p>Enable or disable the info OSD for the specified output.</p> <table> <tr> <td>N1 = A~H</td> <td>[Output port]</td> </tr> </table> <p>Available values for N2:</p> <table> <tr> <td>ON</td> <td>[Enabled]</td> </tr> <tr> <td>OFF</td> <td>[Disabled]</td> </tr> </table>	N1 = A~H	[Output port]	ON	[Enabled]	OFF	[Disabled]
N1 = A~H	[Output port]						
ON	[Enabled]						
OFF	[Disabled]						
GET OUT N1 OSD INFO DISPLAY↵	<p>Show the current info OSD state for the specified output.</p> <table> <tr> <td>N1 = A~H</td> <td>[Output port]</td> </tr> </table>	N1 = A~H	[Output port]				
N1 = A~H	[Output port]						

Matrix Commands

SET OUT N1 ROUTE N2↵	<p>Route the specified input to the specified output.</p> <table> <tr> <td>N1 = A~H</td> <td>[Output port]</td> </tr> <tr> <td>N2 = 1~8</td> <td>[Input port]</td> </tr> </table>	N1 = A~H	[Output port]	N2 = 1~8	[Input port]
N1 = A~H	[Output port]				
N2 = 1~8	[Input port]				
GET OUT N1 ROUTE↵	<p>Show the current input routed to the specified output.</p> <table> <tr> <td>N1 = A~H</td> <td>[Output port]</td> </tr> </table>	N1 = A~H	[Output port]		
N1 = A~H	[Output port]				

COMMAND	
Description and Parameters	
SET OUT ROUTE N1,N1,N1,...↵	<p>Set multiple input/output routes simultaneously.</p> <p>N1 = {A-H}{1-8} [Output and Input port pair]</p> <p><i>Note: Each routing pair consists of the output letter followed by the input number with no space between them. Additional routes are added by separating them with commas (without spaces). (For example: A8,B5,C3,etc.)</i></p>
SET ALL OUT ROUTE N1↵	<p>Route the specified input to all outputs.</p> <p>N1 = 1-8 [Input port]</p>
GET ALL OUT ROUTE↵	<p>Show the current routing for all outputs.</p>
SET CURRENT ROUTE TO PRESET N1↵	<p>Save all current routing assignments to the specified preset.</p> <p>N1 = 1-8 [Preset number]</p>
SET ROUTE PRESET N1↵	<p>Activate the routing assignments saved in the specified preset.</p> <p>N1 = 1-8 [Preset number]</p>
GET ROUTE PRESET N1↵	<p>List the routing assignments stored in the specified preset.</p> <p>N1 = 1-8 [Preset number]</p>
SET ROUTE PRESET N1 NAME N2↵	<p>Set a name for the specified preset.</p> <p>N1 = 1-8 [Preset number]</p> <p>N2 = {Preset Name} [32 characters max]</p>
GET ROUTE PRESET N1 NAME↵	<p>Show the current name of the specified preset.</p> <p>N1 = 1-8 [Preset number]</p>

COMMAND	
Description and Parameters	
SET OUT N1 MASK N2↵	<p>Enable or disable the A/V mute setting on the specified output.</p> <p>N1 = A~H [Output Port]</p> <p>Available values for N2:</p> <p>ON [Mute A/V]</p> <p>OFF [Unmute A/V]</p>
GET OUT N1 MASK↵	<p>Display the current A/V mute setting for the specified output.</p> <p>N1 = A~H [Output port]</p>
SET IN N1 NAME N2↵	<p>Set the name of the specified input.</p> <p>N1 = 1~8 [Input port]</p> <p>N2 = {Input Name} [32 characters max]</p>
GET IN N1 NAME↵	<p>Show the current name of the specified input.</p> <p>N1 = 1~8 [Input port]</p>
SET OUT N1 NAME N2↵	<p>Set the name of the specified output.</p> <p>N1 = A~H [Output port]</p> <p>N2 = {Output Name} [32 characters max]</p>
GET OUT N1 NAME↵	<p>Show the name of the specified output.</p> <p>N1 = A~H [Output port]</p>
GET IN NAME LIST↵	<p>List the names of all inputs on the unit.</p>
GET OUT NAME LIST↵	<p>List the names of all outputs on the unit.</p>

COMMAND

Description and Parameters

SET OUT N1 4K2K DOWNSCALE MODE N2↵

Enable/disable the 4K to 1080p downscale mode used by the specified output.

N1 = A~H [Output port]

Available values for **N2**:

0 [Bypass mode]

2 [Downscale 4K to 1080p]

GET OUT N1 4K2K DOWNSCALE MODE↵

Show the current 4K to 1080p downscale mode state.

N1 = A~H [Output port]

Test Pattern Commands

SET PATTERN N1 MODE N2↵

Enable or disable the test pattern on the specified output.

N1 = A~H [Output port]

Available values for **N2**:

ON [Enabled]

OFF [Disabled]

GET PATTERN N1 MODE↵

Show the current state of the specified output's test pattern mode.

N1 = A~H [Output port]

COMMAND	
Description and Parameters	
SET PATTERN N1 TIMING N2↵	
Set the test pattern's resolution for the specified output.	
N1 = A~H	[Output port]
Available values for N2 :	
6	[720p@60Hz]
10	[1080p@60Hz]
12	[720p@50Hz]
14	[1080p@50Hz]
22	[4K@25Hz]
24	[4K@30Hz]
25	[4K@50Hz]
27	[4K@60Hz]
GET PATTERN N1 TIMING↵	
Show the test pattern's current resolution for the specified output.	
N1 = A~H	[Output port]
GET PATTERN TIMING LIST↵	
List all available test pattern output resolutions with their local index numbers.	
SET PATTERN N1 TYPE N2↵	
Set the test pattern type to use on the specified output.	
N1 = A~H	[Output port]
Available values for N2 :	
1	[Black]
2	[White]
3	[Red]
4	[Green]
5	[Blue]
6	[Magenta]
7	[Yellow]
8	[Cyan]
9	[Color Bar]

COMMAND

Description and Parameters

GET PATTERN N1 TYPE↵

Show the current test pattern type used by the specified output.

N1 = A~H [Output port]

EDID Commands

SET ALL IN EDID MODE N1↵

Select the EDID management mode to use (All or Appoint) for all inputs.

Available values for **N1**:

ON [All mode]

OFF [Appoint mode]

GET ALL IN EDID MODE↵

Show the current EDID management mode used by all inputs.

COMMAND

Description and Parameters

SET ALL IN EDID N1↵

Set the EDID to use when the “All” EDID mode is active.

Available values for **N1**:

1	[Internal 1]
2	[Internal 2]
3	[Internal 3]
4	[Internal 4]
5	[Internal 5]
6	[Internal 6]
7	[User 1]
8	[User 2]
9	[User 3]
10	[User 4]
11	[User 5]
12	[User 6]
13	[User 7]
14	[User 8]
15	[Sink A]
16	[Sink B]
17	[Sink C]
18	[Sink D]
19	[Sink E]
20	[Sink F]
21	[Sink G]
22	[Sink H]

GET ALL IN EDID↵

Show the current EDID used by the “All” EDID mode.

COMMAND	
Description and Parameters	
SET IN N1 EDID N2↵	
Set the EDID to use on the specified input in "Appoint" mode.	
N1 = 1~8	[Input port]
Available values for N2 :	
1	[Internal 1]
2	[Internal 2]
3	[Internal 3]
4	[Internal 4]
5	[Internal 5]
6	[Internal 6]
7	[User 1]
8	[User 2]
9	[User 3]
10	[User 4]
11	[User 5]
12	[User 6]
13	[User 7]
14	[User 8]
15	[Sink A]
16	[Sink B]
17	[Sink C]
18	[Sink D]
19	[Sink E]
20	[Sink F]
21	[Sink G]
22	[Sink H]
GET IN N1 EDID↵	
Show the EDID currently being used on the specified input.	
N1 = 1~8	[Input port]
GET ALL IN EDID LIST↵	
List the EDIDs assigned to all inputs.	
GET IN EDID LIST↵	
List all available EDID selections.	

COMMAND	
Description and Parameters	
SET EDID N1 NAME N2↵	<p>Set the name for the specified EDID.</p> <p>N1 = 7~14 [EDID number]</p> <p>N2 = {EDID Name} [32 characters max]</p> <p><i>Note: Only User EDIDs may be renamed.</i></p>
GET EDID N1 NAME↵	<p>Show the name for the specified EDID.</p> <p>N1 = 1~22 [EDID Number]</p>
GET INTERNAL N1 EDID DATA↵	<p>Show the specified Internal EDID as hex data.</p> <p>N1 = 1~6 [Internal EDID number]</p>
SET USER N1 EDID DATA N2↵	<p>Upload a new EDID (in hex format) for use as the specified User EDID.</p> <p>N1 = 1~8 [User EDID number]</p> <p>N2 = {Hex Data} [EDID data]</p> <p><i>Note: The data block is comma delimited ASCII hex pairs and cannot contain any spaces.</i></p>
GET USER N1 EDID DATA↵	<p>Show the current contents of the specified User EDID as hex data.</p> <p>N1 = 1~8 [User EDID number]</p>
GET SINK N1 EDID DATA↵	<p>Show the EDID from the display connected to the specified output as hex data.</p> <p>N1 = A~H [Output port]</p>
GET IN N1 EDID DATA↵	<p>Show the EDID currently used by the specified input as hex data.</p> <p>N1 = 1~8 [Input port]</p>

COMMAND

Description and Parameters

HDCP Commands

SET IN N1 HDCP MODE N2↵

Set the HDCP behavior of the specified input.

N1 = 1-8 [Input port]

Available values for **N2**:

0	[HDCP Disabled]
1	[Follow Source]
2	[Follow Display]

GET IN N1 HDCP MODE↵

Show the current HDCP behavior used by the specified input.

N1 = 1-8 [Input port]

GET IN N1 HDCP STATUS↵

Show the current HDCP status of the specified input.

N1 = 1-8 [Input port]

Available result codes:

0	[HDCP off]
1	[HDCP 1.x]
2	[HDCP 2.2]

GET OUT N1 HDCP STATUS↵

Show the current HDCP status of the specified output.

N1 = A-H [Output port]

Available result codes:

0	[HDCP off]
1	[HDCP 1.x]
2	[HDCP 2.2]
3	[HDCP 1.x failed]
4	[HDCP 2.2 failed]

COMMAND	
Description and Parameters	
GET IN N1 HDCP ABILITY↵	
Show the HDCP compliance level of the source connected to the specified input.	
N1 = 1~8	[Input port]
Available result codes:	
0	[No HDCP]
1	[HDCP 1.x]
2	[HDCP 2.2]
3	[HDCP 1.4+2.2]
GET OUT N1 HDCP ABILITY↵	
Show the HDCP compliance level of the display device connected to the specified output.	
N1 = A~H	[Output port]
Available result codes:	
0	[No HDCP]
1	[HDCP 1.x]
2	[HDCP 2.2]

Ethernet Commands

SET IP MODE N1↵	
Set the IP address assignment mode.	
Available values for N1 :	
0	[Static IP mode]
1	[DHCP mode]
GET IP MODE↵	
Show the current IP address assignment mode.	
GET IPCONFIG↵	
Show the unit's current IP configuration information.	
SET IPADDR N1↵	
Set the unit's static IP address.	
N1 = X.X.X.X	[X = 0 ~ 255]

COMMAND	
Description and Parameters	
GET IPADDR↵	Show the unit's current IP address.
SET NETMASK N1↵	Set the unit's static netmask. N1 = X.X.X.X [X = 0 ~ 255]
GET NETMASK↵	Show the unit's current netmask.
SET GATEWAY N1↵	Set the unit's static gateway address. N1 = X.X.X.X [X = 0 ~ 255]
GET GATEWAY↵	Show the unit's current gateway address.
GET MAC ADDR↵	Show the unit's MAC address.
SET TELNET PORT N1↵	Set the unit's Telnet access port. N1 = 0~65535 [Port number]
GET TELNET PORT↵	Show the unit's current Telnet access port.
GET HOSTNAME↵	Show the unit's current hostname.
SET WEBGUI USERNAME N1↵	Set the WebGUI "User" login username. N1 = {User Name} [16 characters max]
GET WEBGUI USERNAME↵	Show the current WebGUI "User" login username.

COMMAND	
Description and Parameters	
SET WEBGUI PASSWORD N1↵	
Set the WebGUI "User" login password.	
N1 = {Password}	[16 characters max]
GET WEBGUI PASSWORD↵	
Show the current WebGUI "User" login password.	

Note: Commands will not be executed unless followed by a carriage return. Commands are not case-sensitive.

7. CONNECTION DIAGRAM

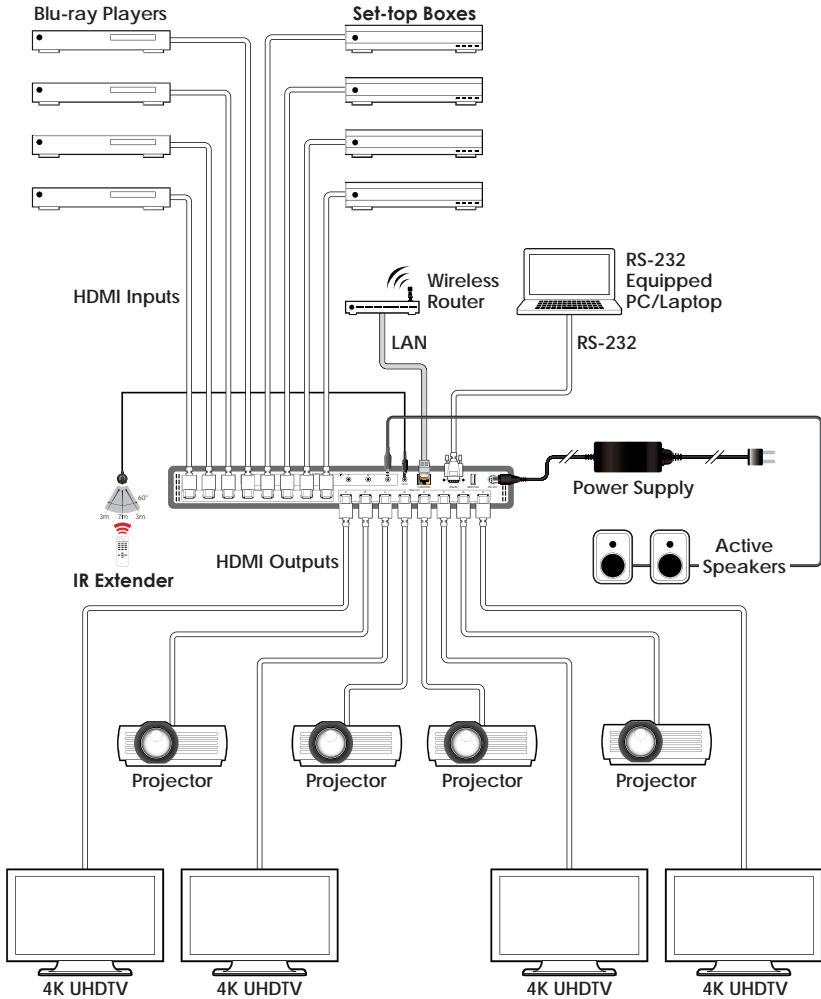

8. SPECIFICATIONS

8.1 Technical Specifications

HDMI Bandwidth	18Gbps
Input Ports	8×HDMI (Type-A)
Output Ports	8×HDMI (Type-A) 8×Analog Stereo (3.5mm)
Control Ports	1×RS-232 (DE-9) 1×Ethernet (RJ-45) 1×IR Extender (3.5mm)
Service Port	1×USB 2.0 (Type A)
IR Frequency	38kHz
Baud Rate	19200
Power Supply	24V/3.75A DC (US/EU standards, CE/FCC/UL certified)
ESD Protection (HBM)	±8kV (Air Discharge) ±4kV (Contact Discharge)
Dimensions (W×H×D)	438mm×44mm×269mm [Case Only] 438mm×49mm×274mm [All Inclusive]
Weight	3,600g
Chassis Material	Metal (Steel)
Chassis Color	Black
Operating Temperature	0°C – 40°C/32°F – 104°F
Storage Temperature	-20°C – 60°C/-4°F – 140°F
Relative Humidity	20 – 90% RH (Non-condensing)
Power Consumption	70W

8.2 Video Specifications

Supported Resolutions (Hz)	Input	Output
	HDMI	HDMI
720×400p@70/85	✓	✓
640×480p@60/72/75/85	✓	✓
720×480i@60	✓	✓
720×480p@60	✓	✓
720×576i@50	✓	✓
720×576p@50	✓	✓
800×600p@56/60/72/75/85	✓	✓
848×480p@60	✓	✓
1024×768p@60/70/75/85	✓	✓
1152×864p@75	✓	✓
1280×720p@50/60	✓	✓
1280×768p@60/75/85	✓	✓
1280×800p@60/75/85	✓	✓
1280×960p@60/85	✓	✓
1280×1024p@60/75/85	✓	✓
1360×768p@60	✓	✓
1366×768p@60	✓	✓
1400×1050p@60	✓	✓
1440×900p@60/75	✓	✓
1600×900p@60RB	✓	✓
1600×1200p@60	✓	✓
1680×1050p@60	✓	✓
1920×1080i@50/60	✓	✓
1920×1080p@24/25/30	✓	✓
1920×1080p@50/60	✓	✓
1920×1200p@60RB	✓	✓

Supported Resolutions (Hz)	Input	Output
	HDMI	HDMI
2560×1440p@60RB	✓	✓
2560×1600p@60RB	✓	✓
2048×1080p@24/25/30	✓	✓
2048×1080p@50/60	✓	✓
3840×2160p@24/25/30	✓	✓
3840×2160p@50/60 (4:2:0)	✓	✓
3840×2160p@24, HDR10	✓	✓
3840×2160p@50/60 (4:2:0),HDR10	✓	✓
3840×2160p@50/60	✓	✓
4096×2160p@24/25/30	✓	✓
4096×2160p@50/60 (4:2:0)	✓	✓
4096×2160p@24, HDR10	✓	✓
4096×2160p@50/60 (4:2:0),HDR10	✓	✓
4096×2160p@50/60	✓	✓

8.3 Audio Specifications

8.3.1 Digital Audio

HDMI Input / Output	
LPCM	
Max Channels	8 Channels
Sampling Rate (kHz)	32, 44.1, 48, 88.2, 96, 176.4, 192
Bitstream	
Supported Formats	Standard & High-Definition



8.3.2 Analog Audio

Analog Output	
Max Audio Level	2Vrms
THD+N	< -60dB@0dBFS 1kHz (A-wt)
SNR	> 105dB@0dBFS
Frequency Response	< ±3dB@20Hz~20kHz
Crosstalk	< -60dB@10kHz
Impedance	470Ω
Type	Unbalanced

8.4 Cable Specifications

Cable Length	1080p		4K30	4K60
	8-bit	12-bit	(4:4:4) 8-bit	(4:4:4) 8-bit
High Speed HDMI Cable				
HDMI Input	15m	10m	5m	3m
HDMI Output	15m	10m	5m	3m

Bandwidth Category Examples:

- **1080p (FHD Video)**
 - Up to 1080p@60Hz, 12-bit color
 - Data rates lower than 5.3Gbps or below 225MHz TMDS clock
- **4K30 (UHD Video)**
 - 4K@24/25/30Hz & 4K@50/60Hz (4:2:0), 8-bit color
 - Data rates higher than 5.3Gbps or above 225MHz TMDS clock but below 10.2Gbps
- **4K60 (UHD⁺ Video)**
 - 4K@50/60Hz (4:4:4, 8-bit)
 - 4K@50/60Hz (4:2:0, 10-bit HDR)
 - Data rates higher than 10.2Gbps

9. ACRONYMS

ACRONYM	COMPLETE TERM
ASCII	American Standard Code for Information Interchange
Cat.5e	Enhanced Category 5 cable
Cat.6	Category 6 cable
Cat.6A	Augmented Category 6 cable
Cat.7	Category 7 cable
CEC	Consumer Electronics Control
CLI	Command-Line Interface
DAC	Digital-to-Analog Converter
dB	Decibel
DHCP	Dynamic Host Configuration Protocol
DVI	Digital Visual Interface
EDID	Extended Display Identification Data
Gbps	Gigabits per second
GUI	Graphical User Interface
HDCP	High-bandwidth Digital Content Protection
HDMI	High-Definition Multimedia Interface
HDR	High Dynamic Range
HDTV	High-Definition Television
IP	Internet Protocol
IR	Infrared
kHz	Kilohertz
LAN	Local Area Network
LCD	Liquid-Crystal Display
LED	Light-Emitting Diode
LPCM	Linear Pulse-Code Modulation
MHz	Megahertz
OSD	On-Screen Display

ACRONYM	COMPLETE TERM
SNR	Signal-to-Noise Ratio
TCP	Transmission Control Protocol
THD+N	Total Harmonic Distortion plus Noise
TMDS	Transition-Minimized Differential Signaling
UHD	Ultra-High-Definition (10.2Gbps)
UHD+	Ultra-High-Definition Plus (18Gbps)
UHDTV	Ultra-High-Definition Television
USB	Universal Serial Bus
VGA	Video Graphics Array
WUXGA (RB)	Widescreen Ultra Extended Graphics Array (Reduced Blanking)
XGA	Extended Graphics Array
Ω	Ohm



CYPRESS TECHNOLOGY CO., LTD.

www.cypress.com.tw