**Axessline QuickBox**

Mounted through table top. PDU is integrated in the lid which opens with a simple press.

Part Check-List

①

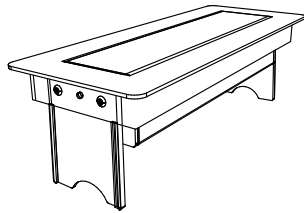

x1

②



x2

- ① To install Axessline Quickbox, a cut out hole must be in place at the desired position of the table. Continue by vertically placing the box ① inside the hole as illustrated below.

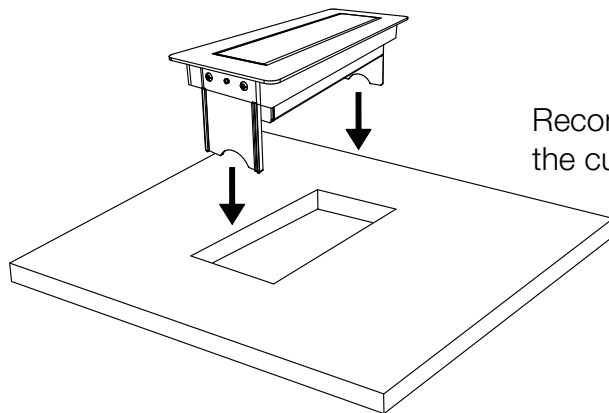

Recommended size of the cut out: $278^{+2}_{-2} \times 92^{+2}_{-0}$ mm.

- ② Once resting on the table, continue from below the table to ascertain its position by sliding the two clamps ② into the tracks of its corresponding counterpart. Continue sliding them all the way to the top.

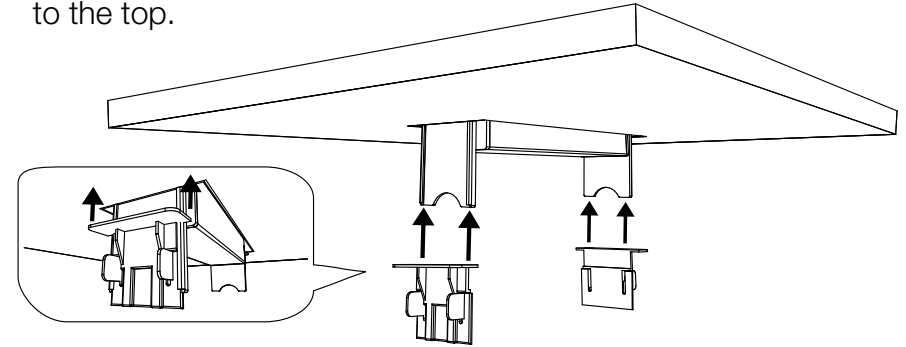

- ③ What remains is to provide the unit with power and finally put it to use.

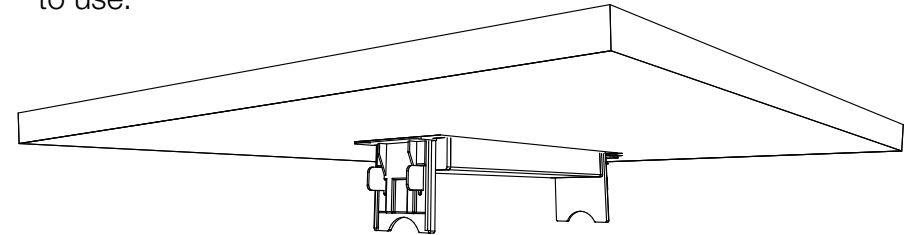

Note! To remove the clamps, pull the top part of the clamp ② away from the box ①. As you pull the top ①, proceed by pulling the clamp downwards until fully removed ②.

