



600 MHz
4K ULTRA HD

4x4 Matrix

w/HDR and Audio De-Embedder

EXT-UHD600A-44

User Manual



Version A1

Important Safety Instructions

1. Read these instructions.
2. Keep these instructions.
3. Heed all warnings.
4. Follow all instructions.
5. Do not use this product near water.
6. Clean only with a dry cloth.
7. Do not block any ventilation openings. Install in accordance with the manufacturer's instructions.
8. Do not install or place this product near any heat sources such as radiators, heat registers, stoves, or other apparatus (including amplifiers) that produce heat.
9. Do not defeat the safety purpose of the polarized or grounding-type plug. A polarized plug has two blades with one wider than the other. A grounding type plug has two blades and a third grounding prong. The wide blade or the third prong are provided for your safety. If the provided plug does not fit into your outlet, consult an electrician for replacement of the obsolete outlet.
10. Protect the power cord from being walked on or pinched particularly at plugs, convenience receptacles, and the point where they exit from the apparatus.
11. Only use attachments/accessories specified by the manufacturer.
12. To reduce the risk of electric shock and/or damage to this product, never handle or touch this unit or power cord if your hands are wet or damp. Do not expose this product to rain or moisture.
13. Unplug this apparatus during lightning storms or when unused for long periods of time.
14. Refer all servicing to qualified service personnel. Servicing is required when the apparatus has been damaged in any way, such as power-supply cord or plug is damaged, liquid has been spilled or objects have fallen into the apparatus, the apparatus has been exposed to rain or moisture, does not operate normally, or has been dropped.
15. Batteries that may be included with this product and/or accessories should never be exposed to open flame or excessive heat. Always dispose of used batteries according to the instructions.

Warranty Information

For the latest warranty coverage information, refer to the Warranty and Return Policy under the Connect section of the Gefen Web site at <http://www.gefen.com/connect/warranty-and-return-policy>

Technical Support

(707) 283-5900 (800) 472-5555
8:00 AM to 5:00 PM Monday - Friday, Pacific Time

Email

support@gefen.com

Web

<http://www.gefen.com>

Mailing Address

Gefen
Core Brands, LLC
c/o Customer Service
1800 S McDowell Blvd
Petaluma, CA 94954 USA

- The information in this manual has been carefully checked and is believed to be accurate. However, Gefen assumes no responsibility for any inaccuracies that may be contained in this manual. In no event will Gefen be liable for direct, indirect, special, incidental, or consequential damages resulting from any defect or omission in this manual, even if advised of the possibility of such damages.
- The technical information contained herein regarding the features and specifications is subject to change without notice.
- For the latest warranty coverage information, refer to the Warranty and Return Policy under the Support section of the Gefen Web site at www.gefen.com.



Important

Cable quality is critical when handling 600 MHz HDMI signals. It is highly recommend that Gefen Locking HDMI cables, 10-foot or shorter, be used in the installation. Gefen HDMI cables have been designed and tested to work at 600 MHz and reliably transport the full 18 Gbps throughput of HDMI 2.0.

© 2017 Core Brands, LLC. All Rights Reserved. All trademarks are the property of their respective owners.

Gefen® is a registered trademark of Core Brands, LLC.

Gefen and Core Brands, LLC reserve the right to make changes in the hardware, packaging, and any accompanying documentation without prior written notice.



This product uses UL-Listed power supplies



This product uses software that is subject to open source licenses, including one or more of the General Public License Version 2 and Version 2.1, Lesser General Public License Version 2.1 and Version 3, BSD, and BSD-style licenses. Distribution and use of this product is subject to the license terms and limitations of liability provided in those licenses. Specific license terms and Copyright Notifications are provided in the source code.

For three years from date of activation of this product, any party may request, and we will supply, for software covered by an applicable license (e.g. GPL or LGPL), a complete machine-readable copy of the corresponding open source code on a medium customarily used for software interchange. The following software and libraries are included with this product and subject to their respective open source licenses:

- lwIP
- jQuery

lwIP is licenced under the BSD licence:

Copyright (c) 2001-2004 Swedish Institute of Computer Science.
All rights reserved.

Redistribution and use in source and binary forms, with or without modification, are permitted provided that the following conditions are met:

1. Redistributions of source code must retain the above copyright notice, this list of conditions and the following disclaimer.
2. Redistributions in binary form must reproduce the above copyright notice, this list of conditions and the following disclaimer in the documentation and/or other materials provided with the distribution.
3. The name of the author may not be used to endorse or promote products derived from this software without specific prior written permission.

THIS SOFTWARE IS PROVIDED BY THE AUTHOR "AS IS" AND ANY EXPRESS OR IMPLIED WARRANTIES, INCLUDING, BUT NOT LIMITED TO, THE IMPLIED WARRANTIES OF MERCHANTABILITY AND FITNESS FOR A PARTICULAR PURPOSE ARE DISCLAIMED. IN NO EVENT SHALL THE AUTHOR BE LIABLE FOR ANY DIRECT, INDIRECT, INCIDENTAL, SPECIAL, EXEMPLARY, OR CONSEQUENTIAL DAMAGES (INCLUDING, BUT NOT LIMITED TO, PROCUREMENT OF SUBSTITUTE GOODS OR SERVICES; LOSS OF USE, DATA, OR PROFITS; OR BUSINESS INTERRUPTION) HOWEVER CAUSED AND ON ANY THEORY OF LIABILITY, WHETHER IN CONTRACT, STRICT LIABILITY, OR TORT (INCLUDING NEGLIGENCE OR OTHERWISE) ARISING IN ANY WAY OUT OF THE USE OF THIS SOFTWARE, EVEN IF ADVISED OF THE POSSIBILITY OF SUCH DAMAGE.

Features*

- Routes four 4K sources to four 4K displays
- Supports resolutions up to 4K Cinema-DCI (4096 x 2160 up to 60 Hz, 4:4:4), 4K Ultra HD (3860 x 2160 up to 60 Hz, 4:4:4) with HDR, 1080p Full HD, and WUXGA (1920x1200)
- Supports HDCP 2.2 and 1.4
- Supports HDR (High Dynamic Range) 10-bit Deep Color at 4K 60 Hz 4:2:0 and 4K 24 Hz 4:4:4
- Supports 12-bit Deep Color at 1080p Full HD (60 Hz 4:4:4) and Dolby Vision 12-bit Deep Color; Rec. 2020 color space support - Pass through
- 3DTV pass-through
- Lip Sync pass-through
- EDID Management for rapid integration of source and displays
- Supports uncompressed LPCM digital audio up to 7.1 channels
- Supports up to 7.1 channels of HBR (High Bit Rate) digital audio including Dolby Atmos®, Dolby® TrueHD, DTS:X™, and DTS-HD Master Audio™
- Supports the use of DVI sources and DVI displays up to 1080p Full HD and WUXGA (1920x1200), with Gefen CAB-DVI2-HDMI-LCK DVI-to-HDMI cables (not included)
- Built-in Audio De-Embedders break out 2 channel analog, 2 channel PCM, and up to 5.1 channels of Bitstream audio from each HDMI output, allowing the audio content to be sent to external amplifiers and music distribution systems for added impact.
- 4 independent scalers allow upscaling from 1080p to 4K on two outputs and downscaling from 4K to 1080p on the other two, maximizing compatibility in a mixed-resolution display system
- Variable and fixed volume
- 2 USB power ports for use with sources requiring a USB power supply, 2 A shared
- Enhanced API facilitates added functionality with third-party control systems.
- Long Reach Power (LRP) provides 500 mA at 5V on pin 18 of HDMI outputs 1 and 2. Enables select extender devices to be powered through their HDMI input port
- Locking power connector
- Push button controls
- RS-232 Serial control interface for use with a third-party controller
- IP control via Telnet, UDP, and the built-in web server interface
- IR remote control
- Gefen Syner-G™ software simplifies initial IP configuration and EDID Management
- Field-updatable firmware via web server interface
- 1 U tall enclosure, rack ears included
- Can be placed on a shelf or mounted in a standard 19-inch wide rack

* Features and specifications are subject to change without notice.

Packing List

The Ultra HD 600 MHz 4x4 Matrix w/ HDR and Audio De-Embedder ships with the items listed below. If any of these items are not present in the box when you first open it, immediately contact your reseller or Gefen.

- 1 x 4K Ultra HD 600 MHz 4x4 Matrix
- 1 x 24V DC Power Supply (EXT-PS24U-O-6)
- 1 x AC Power Cord
- 2 x Rack Ears
- 4 x Machine screws for Rack Ears
- 4 x Self-Adhesive Rubber-Feet
- 1 x IR Extender (EXT-RMT-EXTIRN)
- 1 x IR Remote (RMT-44A)
- 1 x Quick-Start Guide

1 Getting Started

Introduction.....	2
Front Panel.....	2
Rear Panel.....	3
IR Remote Control.....	4
Installing the Batteries.....	6
Setting the IR Channel.....	7
Installation.....	8
Connection Instructions.....	8
Application Diagram.....	9
Network Configuration using Syner-G.....	10

2 Basic Operation

Using the IR Extender.....	14
Viewing the Routing Status.....	15
Routing Inputs to Outputs.....	16
Using the Front Panel.....	16
Using the IR Remote Control.....	17
Masking / Unmasking Outputs.....	18
Locking / Unlocking the Matrix.....	19
Routing Presets.....	20
Volume Control.....	21
Increasing / Decreasing Volume.....	21
Muting / Unmuting Audio.....	23
The Web Interface.....	24
Introduction to the Web Interface.....	24
Locking the Matrix.....	29
Viewing the Routing Status.....	30
Routing Inputs and Masking Outputs.....	31
Routing Presets.....	34
Input and Output Status.....	37
Changing Input and Output Names.....	38
Video.....	39
Audio.....	40
HPD Control.....	41
HDCP.....	42
Setting the EDID Mode.....	44
Copying EDID Data.....	46
Getting EDID Information.....	48
Uploading and Downloading EDID Data.....	49
Configuring Network Settings.....	52
System Settings.....	58

3 Advanced Operation

Using Telnet, UDP, and RS-232	68
Telnet Configuration	68
UDP Configuration	68
RS-232 Configuration	69
Commands	70
Discovery Service	70
Input Status	70
Manage EDID	70
Network Settings	71
Output Status	72
Presets	72
Routing	72
Setup	73
System Settings	73
Volume	73

4 Appendix

Network Cable Diagram	168
Default Settings	169
Internal EDID Profiles	170
Specifications	175

This page left intentionally blank.

This page left intentionally blank.

600 MHz
4K ULTRA HD

4x4 Matrix

w/HDR and Audio De-Embedder

1

Getting Started

Front Panel

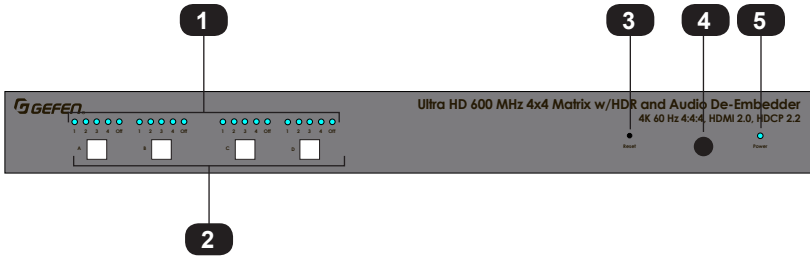

ID	Name	Description
1	Input indicators	These blue LED indicators display the state of each input. See Routing Inputs to Outputs (page 16) for more information.
2	Output Selection Buttons (A - D)	Press these buttons to select the desired output. See Routing Inputs to Outputs (page 16) for more information.
3	Reset	Press and hold this button for 10 seconds and release to reset the matrix to factory-default settings.
4	IR	This IR sensor receives signals from the included IR remote control unit.
5	Power	This LED will glow bright blue when the matrix is powered.

Rear Panel

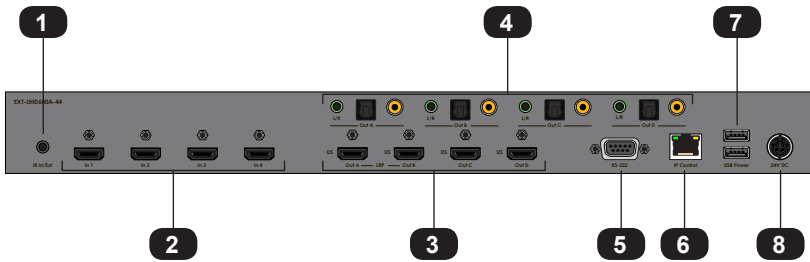

ID	Name	Description
1	IR In / Ext	Connect an IR extender (Gefen part no. EXT-RMT-EXTIRN) or an electrical IR cable from an automation system to this port.
2	In (1 - 4)	Connect up to four 4K Ultra HD source devices to the matrix using these HDMI ports.
3	Out (A - D)	Connect up to four 4K Ultra HD displays to the matrix using these HDMI ports. See Connection Instructions (page 8) for more information.
4	Audio outputs	Each HDMI output provides a three separate ports for audio de-embedding: 1) L/R (analog), 2) coax (digital), 3) TOSLINK® (digital).
5	RS-232	Connect the RS-232 cable from this port to an RS-232 device. See Connection Instructions (page 8) for more information.
6	IP Control	Connect an Ethernet cable between this jack and a LAN. See Connection Instructions (page 8) for more information.
7	USB Power	Connect up to two USB-powered devices. Combined maximum current output is 2A.
8	24V DC	Connect the included 24V DC power supply to this power connector.

IR Remote Control

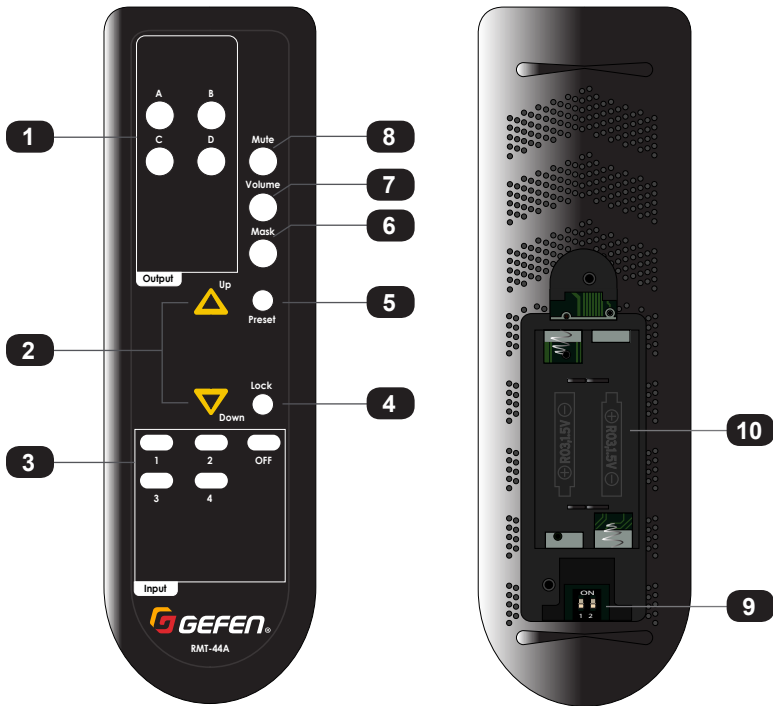

ID	Name	Description
1	Output buttons (A - D)	Press these buttons to select the desired input when performing routing operations. Each button corresponds to an Out port (A - D) on the rear panel of the matrix.
2	▲, ▼	Press these buttons to increase or decrease the output volume. See Increasing / Decreasing Volume (page 21) for more information.
3	Input buttons (1 - 4)	Press these buttons to select the desired input when performing routing operations. Each button corresponds to an In port (1 - 4) on the rear panel of the matrix. Press the Off button to set the input to the Off state, to simulate a source that is not connected.

ID	Name	Description
4	Lock	Press this button to toggle between locking and unlocking the buttons on the front panel.
5	Preset	Press this button to select the desired preset. See Routing Presets (page 20) for more information.
6	Mask	Press this button to mask the desired output. See Masking / Unmasking Outputs (page 18) for more information.
7	Volume	Adjusts the output volume on the selected output. See Increasing / Decreasing Volume (page 21) for more information.
8	Mute	Press this button to mute all audio. See Muting / Unmuting Audio (page 23) for more information.
9	DIP switches	Sets the IR channel of the IR remote control. In order for the IR remote control to communicate with the matrix, both the IR remote control and the matrix must be set to the same IR channel. See Setting the IR Channel (page 7) for setting the IR channel of the IR remote control. Use Web GUI to set the IR channel of the matrix. See System Settings (page 73) for more information.
10	Battery compartment (shown open)	Accepts two 1.5V AAA-type batteries. See Installing the Batteries (page 6) for more information.

Installing the Batteries

1. Remove the back cover the IR remote control unit.
2. Insert two 1.5V AAA-type batteries, as shown, within the battery compartment.

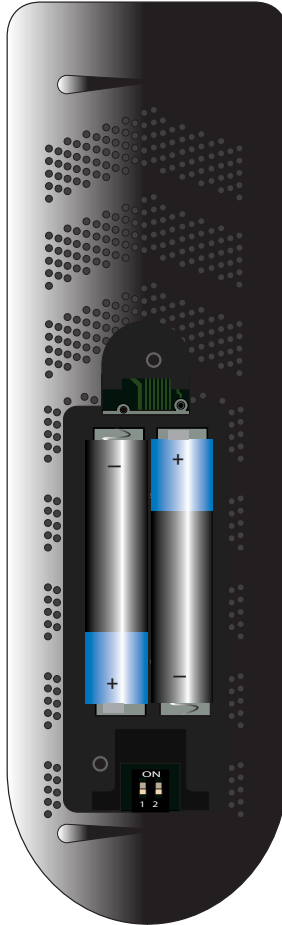

3. Replace the back cover.



Warning!

Risk of explosion if battery is replaced by an incorrect type. Dispose of used batteries according to the instructions.

Setting the IR Channel

Use the following DIP switch settings to set the IR channel of the IR remote control. In order for the included IR remote control to communicate with the matrix, the IR remote control must be set to the same channel as the matrix.

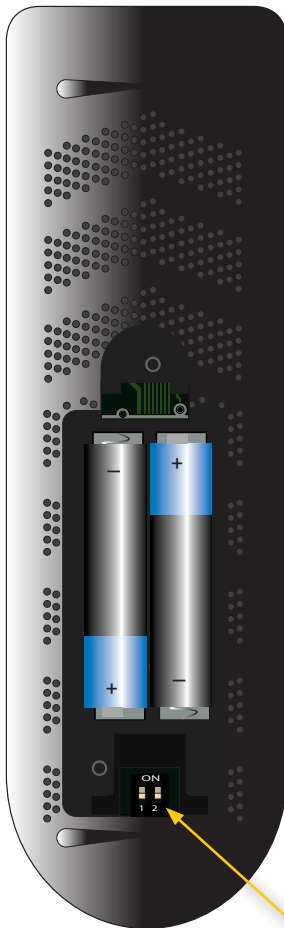

Channel 1 (default): Channel 2:



DIP1 = OFF
DIP2 = OFF



DIP1 = ON
DIP2 = OFF

Channel 3:



DIP1 = OFF
DIP2 = ON

Channel 4:



DIP1 = ON
DIP2 = ON

DIP switches

Connection Instructions

▶ Video

1. Connect an HDMI cable from each 4K Ultra HD source device to the **In** ports (1 - 4) on the rear panel of the matrix. Up to four source devices can be connected.
2. Connect a 4K Ultra HD display to each of the **Out** ports (A - D) on the rear panel of the matrix. Up to four displays can be connected. Use the ports marked “DS” to allow for optional down-scaling of the source signal. Use the “US” ports to provide optional up-scaling capability.

▶ Audio De-embedding

3. The matrix provides one analog and two digital outputs for each HDMI output for audio de-embedding:
 - a. Connect a 3.5mm mini-stereo cable from each **L/R** port to an A/V receiver.
 - b. Connect a RCA cable from each coax port to an A/V receiver.
 - c. Connect an optical cable from each TOSLINK® port to an A/V receiver.

▶ IP Control

4. Connect a shielded CAT-5e (or better) cable from the IP Control port on the rear panel of the matrix to the Local Area Network. See [Network Configuration using Syner-G \(page 10\)](#) for more information on configuration.

▶ RS-232 (optional)

5. Connect a DB-9 cable from the RS-232 port on the rear panel of the matrix to the automation device. See [RS-232 Configuration \(page 69\)](#) for more information.

▶ IR Control (Optional)

6. Connect an IR extender (Gefen part no. EXT-RMT-EXTIRN) or an electrical IR cable from an automation system to the **IR In / Ext** port on the rear panel of the matrix. Connecting an IR extender is useful if the IR sensor on the front panel will be hidden from view.

▶ Power

7. Connect the included 24V DC power supply to the power connector on the matrix.
8. Connect the AC power cord to the power supply and connect the power cord to an available electrical outlet.

Application Diagram

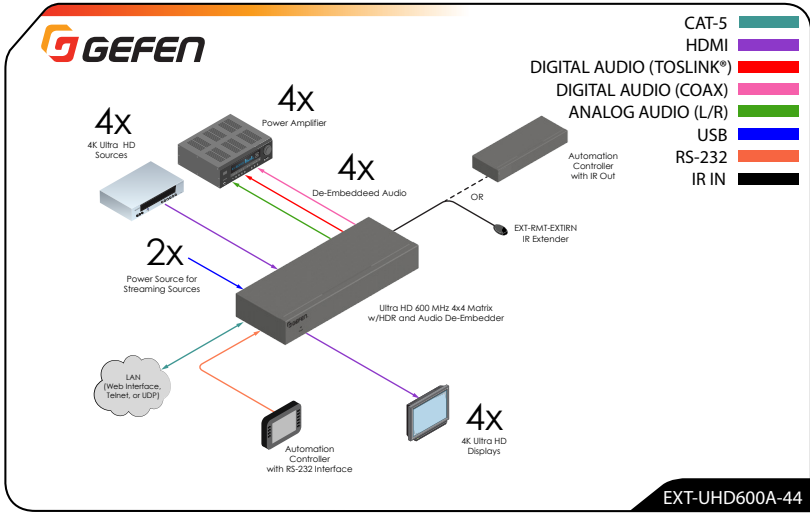

Network Configuration using Syner-G

1. Launch the Gefen Syner-G application.
Download the application here: <http://www.gefen.com/support/download.jsp>
2. Select the matrix (EXT-UHD600A-44) from the list of products.

Discover	Configure	Manage EDID	Update
My PC	10.5.64.90	00:1D:09:7E:E1:1F	Loc
Product Name	IP Address	MAC Address	
EXT-UHD600A-44	192.168.0.172	00:1C:91:04:D0:04	EXT
EXT-MFP	10.5.64.52	00:1C:91:04:50:05	EXT
GEF-UHDA-88-HBT2	10.5.64.181	00:1C:91:04:90:21	GEF
EXT-CU-LAN	10.5.64.151	00:1C:91:04:60:17	EXT

3. Under the Device Settings section, select either Static or DHCP from the IP Mode drop-down list.
 - ▶ Select **Static** to manual enter the IP address, subnet mask, and gateway IP. Consult with your network administrator, if necessary.
 - ▶ Select **DHCP** to let the DHCP server automatically assign the IP address, subnet mask, and gateway IP.

Device Settings		
EXT-UHD600A-44	IP Mode	Static
00:1C:91:04:D0:04	Web GUI Port	Static DHCP Auto
0.5.64.205	Telnet Port	23
55.255.255.0	Firmware Version	V1.0B
0.5.64.1	Hardware Version	V1.0
	Description	EXT-UHD600A-44

- Click the **Save** button at the bottom of the screen.

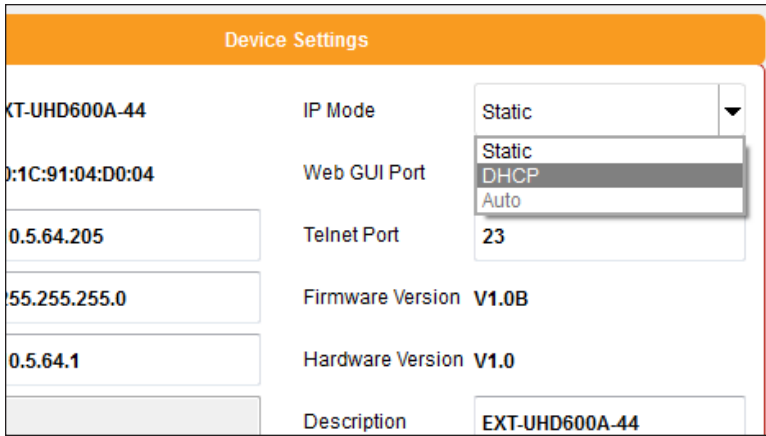

Device Settings		
KT-UHD600A-44	IP Mode	Static
08:1C:91:04:D0:04	Web GUI Port	Static
0.5.64.205	Telnet Port	DHCP
55.255.255.0	Firmware Version	23
0.5.64.1	Hardware Version	V1.0B
	Description	V1.0
		EXT-UHD600A-44

- The matrix will automatically reboot and use the new network settings.
- Use the IP address of the matrix to access the built-in web interface or start a Telnet session. See the following for more information:
 - ▶ [The Web Interface \(page 24\)](#)
 - ▶ [Using Telnet, UDP, and RS-232 \(page 68\)](#)

This page left intentionally blank.

600 MHz
4K ULTRA 

4x4 Matrix

w/HDR and Audio De-Embedder

2 Basic Operation

Using the IR Extender

There may be situations where the IR sensor is blocked by a cabinet or other mounting device. In this case, the included IR extender (Gefen part no. EXT-RMT-EXTIRN) can be connected to the **IR In/Ext** port on the rear panel of the matrix. The sensor on the IR extender behaves exactly like the sensor on the front panel of the matrix. Always point the IR remote control unit in the direction of the IR sensor.

The **IR In/Ext** port can also receive electrical IR signals from an Automation Control System. Connect a 3.5mm-to-3.5mm mini-stereo cable from the **IR In/Ext** port to the port on the control system.

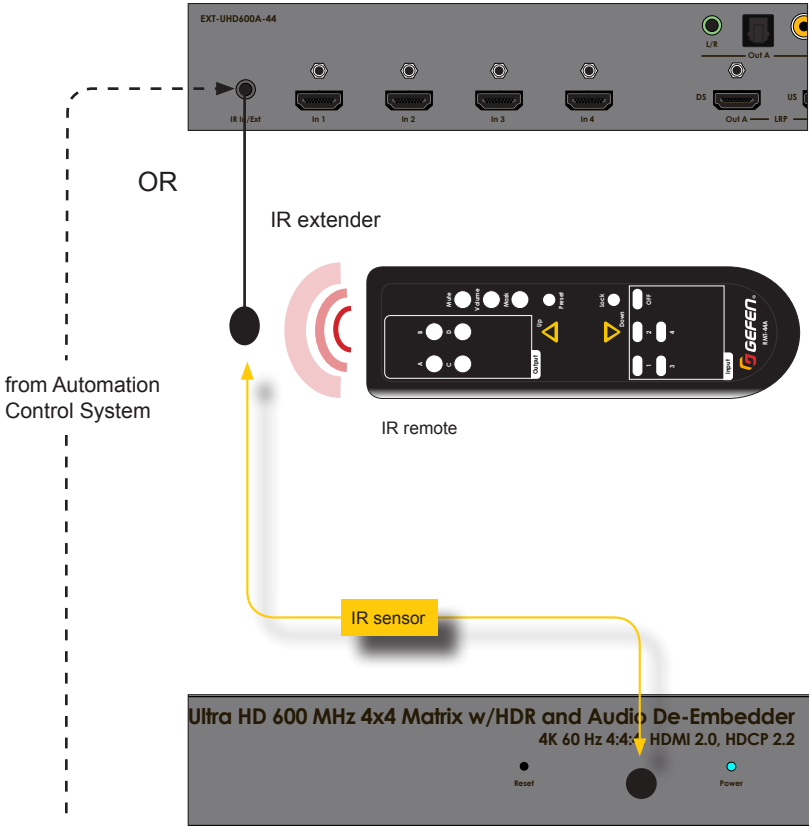

Viewing the Routing Status

On the top-left portion of the matrix, there are four sets of five LED indicators. Each set of five LED indicators resides above each of the four output buttons.

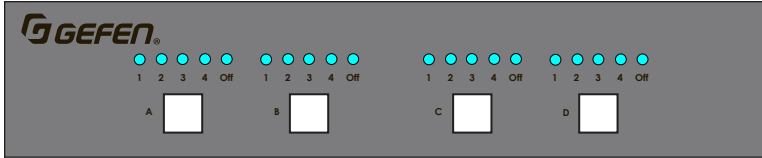

LED indicators 1 through 4 represent each input on the matrix. If one of these LED indicators are illuminated, then that means that the input is active.

The “Off” LED indicates that the output is turned off (masked). Refer to [Masking / Unmasking Outputs \(page 18\)](#) for more information on masking and unmasking outputs.

Each of the output buttons are used to route inputs to outputs. When an output button is illuminated, it represent the currently selected output. For example, in the illustration below, **Input 1** has been routed to **Output A**:

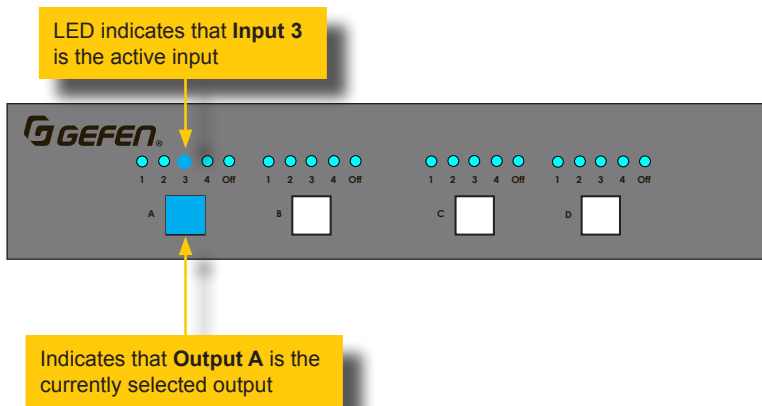

In addition, in the above illustration, Input 2 is routed to **Output B**, Input 3 is routed to **Output C**, and Input 4 is routed to **Output D**. If the number of the input is the same as the number of the output, then this is called the “one-to-one” routing state. This is the factory-default routing state of the matrix.

When the matrix is shipped from the factory, the matrix is set to “one-to-one” routing mode. This means that **Input 1** is routed to **Output A**, **Input 2** is routed to **Output B**, **Input 3** is routed to **Output C**, and so on. To change the routing state for any output, follow the instructions below.

Using the Front Panel

To change the routing state of an output, press and release the button of the desired output to advance to the next input.

In the illustration below, the source connected to **Input 2** is currently routed to **Output B**. For this example, we will route **Input 4** to **Output B**.

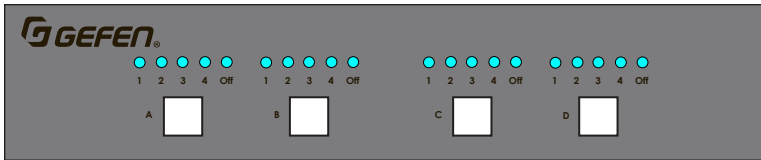

1. Select output 2 by pressing button **B**. The LED for **2** is illuminated, indicating that **Input 2** is currently routed to **Output B**.

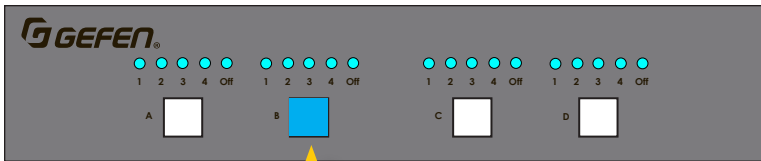

2. Press button **Output 2**, twice.

Input 4 is selected

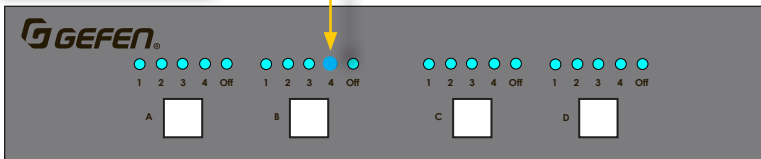

3. The LED indicator for **Input 4** is now illuminated. This indicates that **Input 4** is now routed to **Output B**.

Using the IR Remote Control

In the example below, the same routing example, outlined on the previous page, is used.

1. Point the IR remote at the IR sensor on the front panel of the matrix.
2. Select the desired input. In this example, we will select Input 4. Always select the input *before* selecting the output.

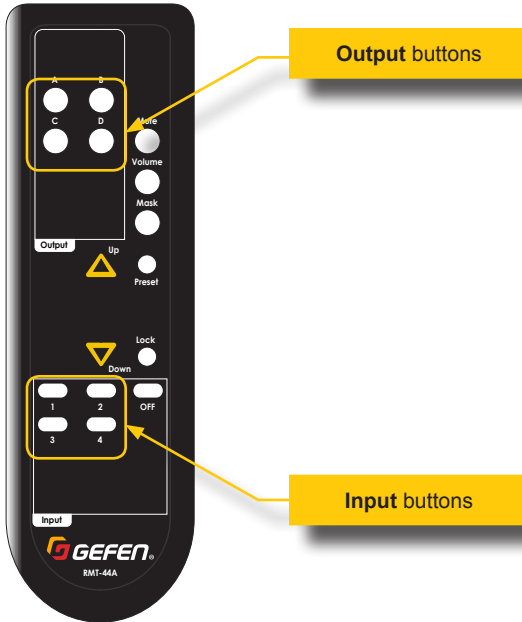

3. Select the desired output. In this example, we will select **Output B**.
4. The LED indicator for **Input 4** is now illuminated. Input 4 is now routed to **Output B**.

Input 4 is selected

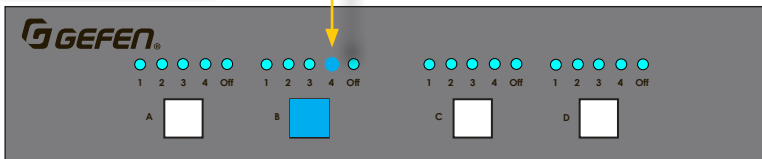

When masking outputs through the front panel, the IR remote control *must* be used. Outputs can also be masked by using the built-in web interface. See [Routing Inputs and Masking Outputs \(page 31\)](#) for more information.

When an output is masked, the signal is blocked at the output. For example, if **Input 2** is routed to **Output A**, **Output B**, and **Output C**. If **Output B** is masked, then only the A/V signal on **Output B** will be blocked. **Output A** and **Output C** will remain unaffected.

1. Press the **Mask** button on the IR remote. This will cause all the output buttons (A, B, C, D), on the front panel of the matrix, to start flashing.

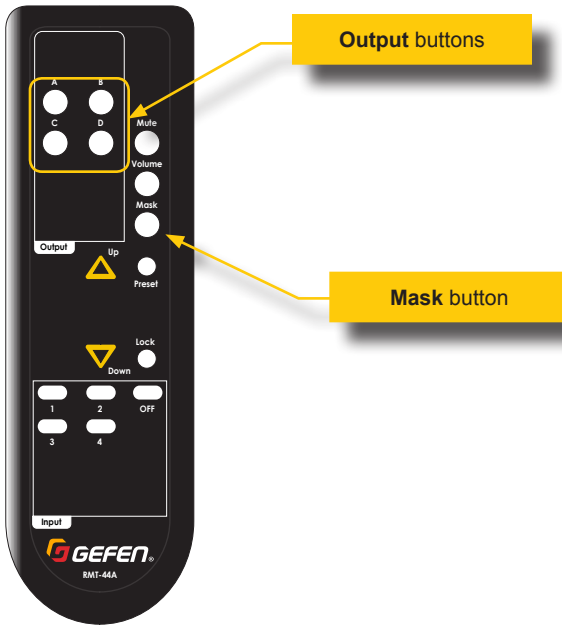

2. Press the desired output button on the IR remote to be masked/unmasked. The associated output button, on the front panel of the matrix, will illuminate for approximately one second, and then exit mask mode.

The matrix will wait approximately three seconds for a response from the IR remote. If no mask operation takes place, or if any other button on the IR remote is pressed, then the matrix will exit mask mode.

3. To unmask a masked output, repeat the above steps.

Locking / Unlocking the Matrix

To prevent an accidental routing change, the front-panel buttons on the matrix can be locked. Locking the matrix disables the front-panel controls, IR, and the built-in web interface.

1. Point the included IR remote control toward the IR sensor on the matrix and press the **Lock** button.
2. The matrix is now locked.
3. Press the **Lock** button, again, to unlock the matrix.

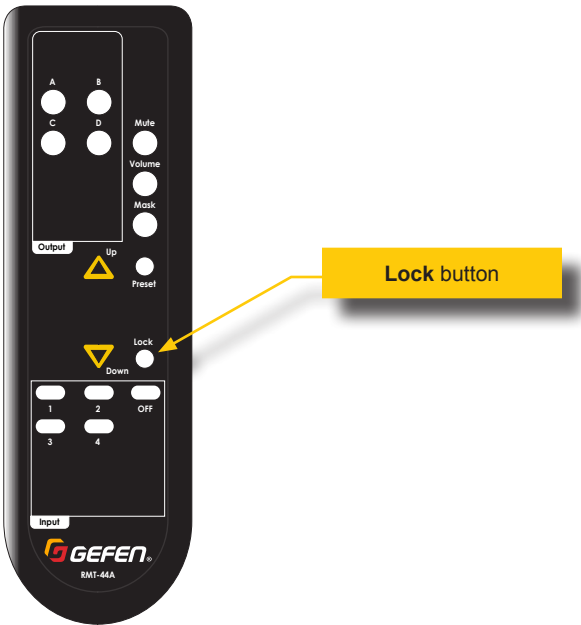

Routing presets can be recalled using the IR remote control. For information on creating presets, see [Routing Presets \(page 34\)](#).

1. Press the **Presel** button on the IR remote control. This will cause all the output buttons (A, B, C, D), on the front panel of the matrix, to start flashing.

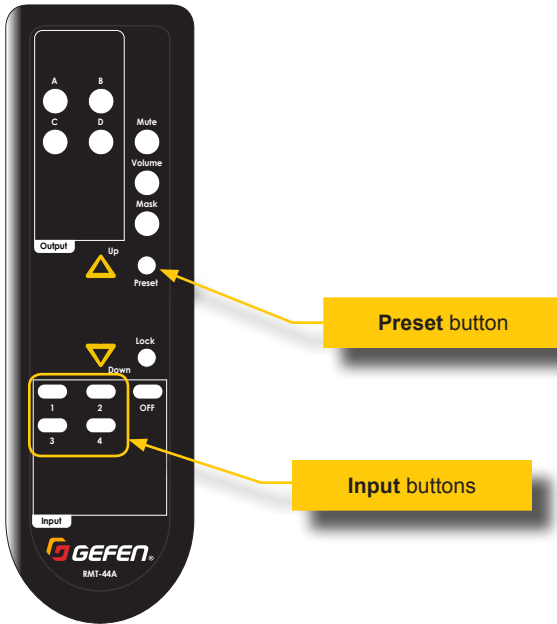

2. Use the desired **Input** button, from the bottom-portion of the IR remote control, to select the desired preset. *Note that only presets 1 through 4 can be recalled using the IR remote control. To access all 16 presets, use the built-in web interface. See [Routing Presets \(page 34\)](#) for more information.* Once the preset is selected, the associated output button, on the front panel of the matrix, will illuminate to indicate which preset was selected.

The matrix will wait approximately three seconds for a response from the IR remote. If no mask operation takes place, or if any other button on the IR remote is pressed, then the matrix will exit the preset-selection mode.

3. The preset is now loaded and the routing state, stored in the preset, will be applied to the matrix.

Increasing / Decreasing Volume

Use the included IR remote to adjust the output volume.

1. Press the **Volume** button on the IR remote. This will cause all the output buttons (A, B, C, D), on the front panel of the matrix, to start flashing.

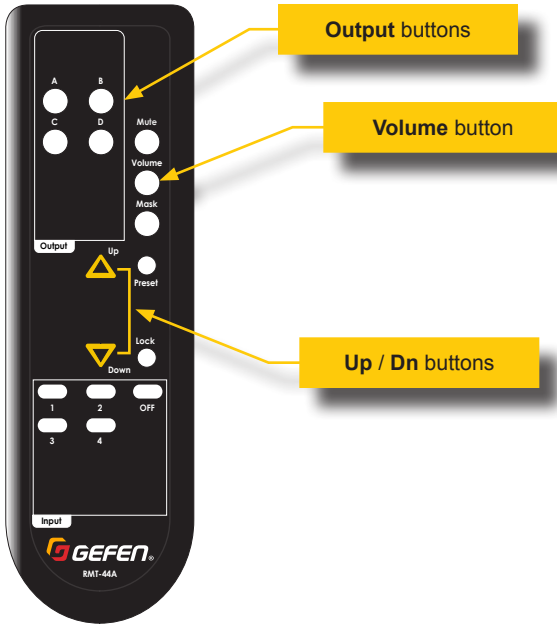

2. Press the desired output button on the IR remote to affect the volume control of the output. The associated output button, on the front panel of the matrix, will begin to flash.
3. Adjust the volume by pressing the **Up** or **Dn** buttons on the IR remote.

Information

 If the output volume mode is set to fixed, then the operation will be immediately cancelled.

4. The front-panel input LED indicators will provide a specific response, depending upon whether the **Up** or **Dn** button is pressed, as described on the following page.

- When the **Up** button is pressed, all **Input** (1, 2, 3, 4) and **Off** LED indicators, for that output, will flash to acknowledge that the matrix has received the volume-up command.

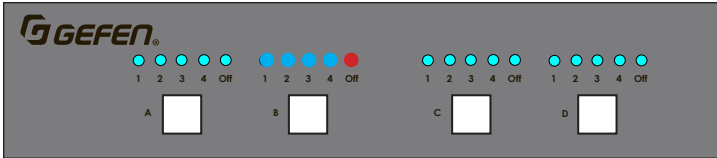

Volume-up command received for Output B

- When the **Dn** button is pressed, the **Input 3** LED indicator, for that output, will flash to acknowledge that the matrix has received the volume-down command.

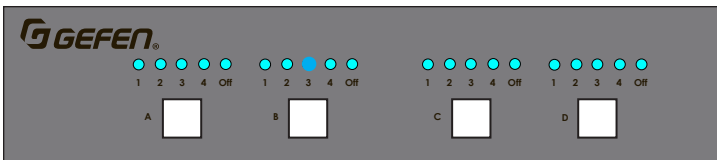

Volume-down command received for Output B

The matrix will wait approximately six seconds for a response from the IR remote. If no volume operation takes place, or if any other button on the IR remote is pressed, then the matrix will exit the volume-adjust mode.

- When the **Up** button is pressed, all **Input** (1, 2, 3, 4) and **Off** LED indicators, for that output, will flash to acknowledge that the matrix has received the volume-up command.
- When the **Down** button is pressed, the **Input 3** LED indicator, for that output, will flash to acknowledge that the matrix has received the volume-down command.

Muting / Unmuting Audio

1. Press the **Mute** button on the IR remote. This will cause all the output buttons (A, B, C, D), on the front panel of the matrix, to start flashing. Note that muting or unmuting affects all audio ports per output channel.

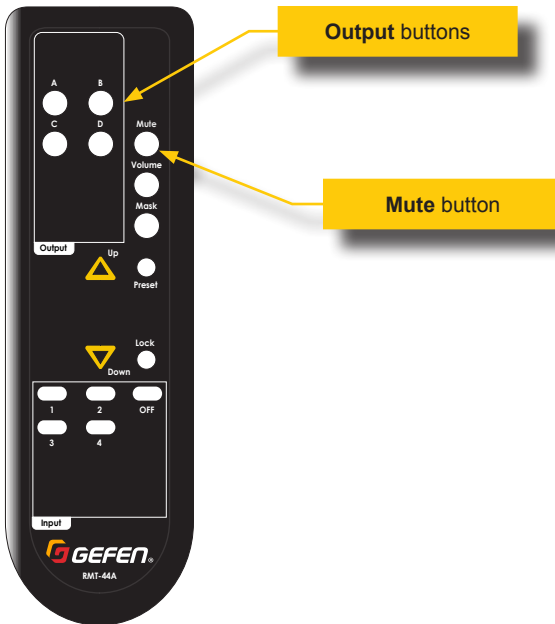

2. Press the desired output button on the IR remote to mute the audio on the output. The associated output button, on the front panel of the matrix, will illuminate for approximately one second, and then exit mute mode.

The matrix will wait approximately three seconds for a response from the IR remote. If no mute takes place, or if any other button on the IR remote is pressed, then the matrix will exit muting mode.

3. To unmute the audio, repeat the above steps.

Introduction to the Web Interface

The Ultra HD 600 MHz 4x4 Matrix w/HDR and Audio De-Embedder includes a built-in web interface. We recommend that the web interface be used to control the matrix as it provides easy management of all features used by the matrix.

▶ Logging In

1. Launch your favorite web browser.
2. In the address bar, type the IP address of the matrix.
3. The login page will be displayed.
4. Select the user from the **Username** drop-down list.

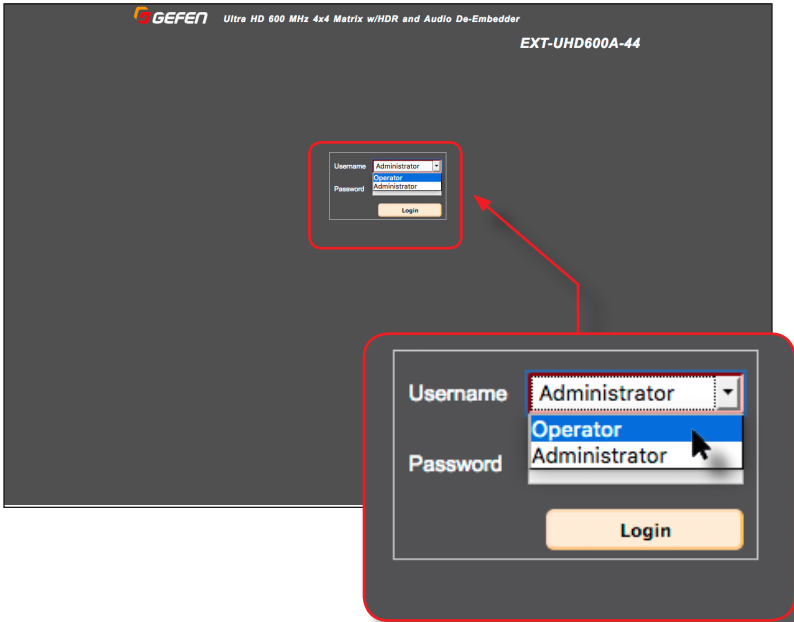

- **Operator**
The Operator username provides restricted access to the web interface. This username allows access to both the Routing and Status tabs, locking / unlocking and powering on / off the matrix.

The default password for the Operator user name is `Operator`. All passwords are case-sensitive. For information on changing the default password, see [Configuring Network Settings \(page 52\)](#).

- **Administrator**

The Administrator username provides full access to all features within the web interface.

The default password for the Administrator user name is `Admin`. All passwords are case-sensitive. For information on changing the default password, see [Configuring Network Settings \(page 52\)](#).

5. Enter the password for the selected username.
6. Click the **Login** button.
7. After a few moments, the **Routing** tab will be displayed.

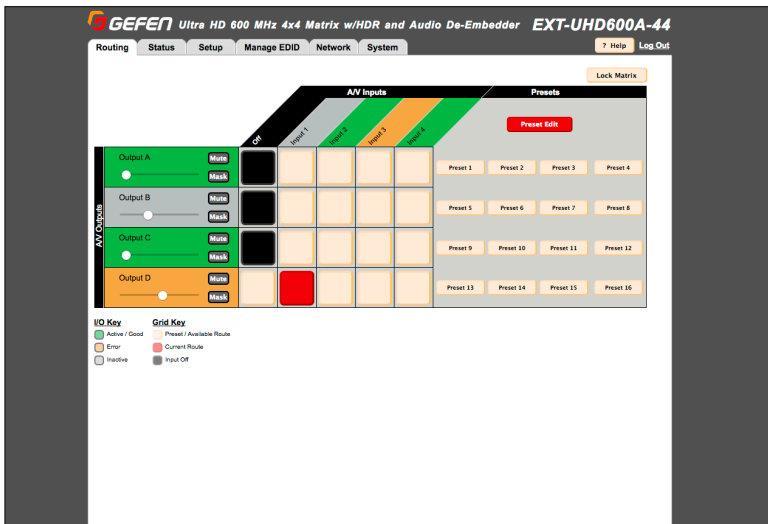

► **Administrator vs Operator**

As mentioned earlier, logging in as `Operator` provides restricted access to many of the available features within the web interface. This is summarized in the table below:

Administrator	Operator
<ul style="list-style-type: none"> • Access to all features 	<ul style="list-style-type: none"> • Access to Routing and Status tabs, only. • No access to the Presets Edit button under the Routing tab.

► Tabs and Sub-tabs

The web interface is organized into tabs, in the top-portion of the screen. Clicking on a tab will display a different screen.

The **Setup** and **Manage EDID** tab have their own set of tabs, which we will refer to as “sub-tabs”, as shown below.

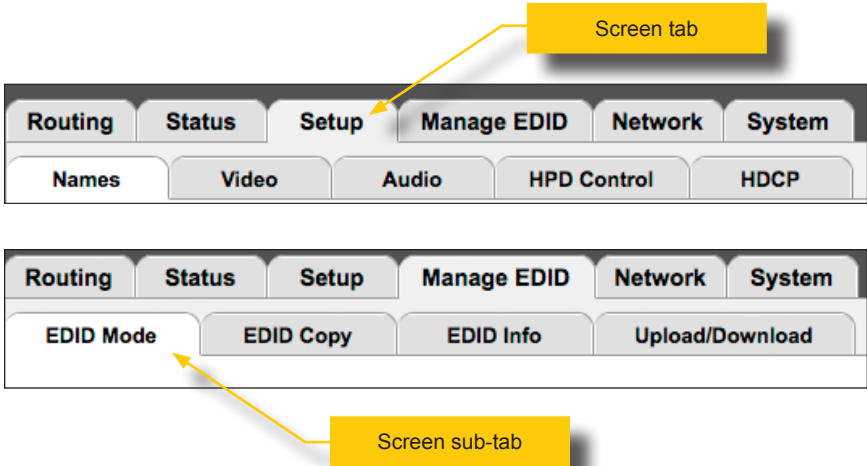

► Buttons

Several screen contain buttons which allow the selection of a particular mode or setting. Click the button for the desired setting. Buttons that are red represent a setting that is “turned on”. If the button is pale-yellow, then the feature is “turned off”:

- Feature is “turned on”



- Feature is “turned off”

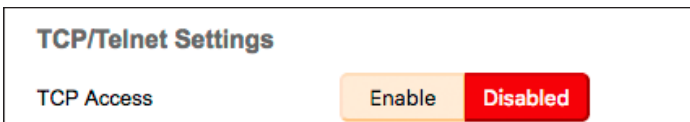

- If a button is “grayed-out”, then this means that the setting is not available. This usually requires that another setting must be *enabled* before setting a “sub-set” of that feature.

For example, note that both the **Login Message on Connect** buttons are disabled in the illustration, below:

TCP/Telnet Settings

TCP Access Enable Disabled

TCP Port

Login Message on Connect Show Hide

In order to change this setting, the **TCP Access** must be enabled.

After clicking the **Enable** button, next to **TCP Access**, the **Login Message on Connect** buttons are now available.







Telnet Settings

Access Enabled Disable

Port

► Legend

The legend, near the bottom-right corner of the screen, defines the colors used to indicate the status of an input or output:

I/O Key	Grid Key
 Active / Good	 Preset / Available Route
 Error	 Current Route
 Inactive	 Input Off

- Active / Good**
Columns or rows that are highlighted in green, indicate that an active source or sink is connected to the that input / output.
- Error**
Although a rare occurrence, this indicates an error (e.g. HDCP, etc.) with the source or sink device. These rows or columns are highlighted in amber.
- Inactive**
Columns or rows which are highlighted in gray, indicate the absence of a source or sink device on that input or output.
- Preset / Available Route**
Squares that are light tan, indicate that the input and output is available for routing.
- Switch Audio / Video**
A red square indicates where an input has been routed to an output.
- Off**
Black squares indicate that the input is set to the OFF state. The OFF input is an additional input that can be selected to simulate a source that is not present.

		A/V Inputs					
		Off	Input 1	Input 2	Input 3	Input 4	
Output A	<input type="checkbox"/> Mute <input type="checkbox"/> Mask						Preset 1
Output B	<input type="checkbox"/> Mute <input type="checkbox"/> Mask						Preset 5
Output C	<input type="checkbox"/> Mute <input type="checkbox"/> Mask						Preset 9
Output D	<input type="checkbox"/> Mute <input type="checkbox"/> Mask						Preset 13

Locking the Matrix

Locking the matrix disables the front-panel controls, IR routing, and the built-in web interface. This is useful in preventing an accidental change to matrix settings by inadvertently pressing any of the front-panel buttons.



Information

Locking the Matrix Controller will also disable routing and other operations within the Web Interface.

1. Click the **Routing** tab.
2. Click the **Lock** button near the top of the screen.

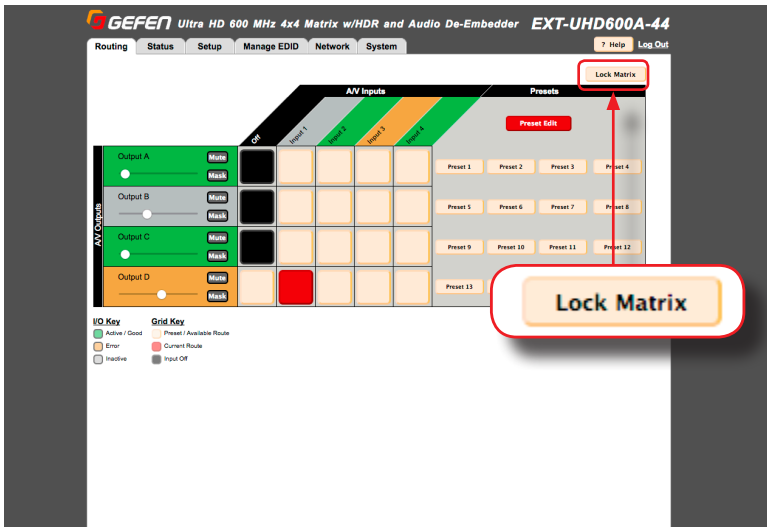

3. Once pressed, the **Lock** button will read "Unlock Matrix". The Lock button on the front panel will also glow bright blue. The matrix is now locked.
4. Click the **Unlock Matrix** button to unlock the matrix.



5. The **Unlock** button will now read "Lock". The **Lock** button on the front panel will also turn-off. The matrix is now unlocked.

Viewing the Routing Status

1. Click the **Routing** tab.

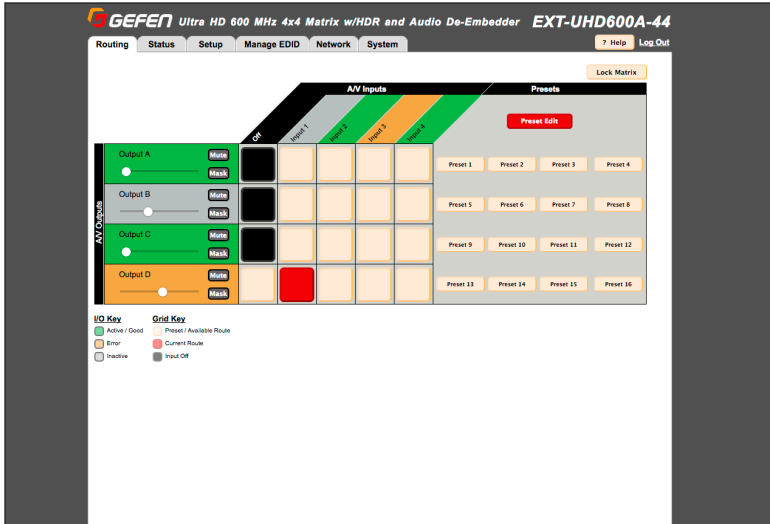

2. Locate the desired output from the rows on the left, then read across until a routing indicator (red square) is encountered.

Note the column where the red square is located. Each column identifies an input and each row represents an output. The output and inputs names can be changed, if desired. See [Changing Input and Output Names \(page 38\)](#) for more information.

For example, in the illustration below, **Input 2** is routed to **Output C**.

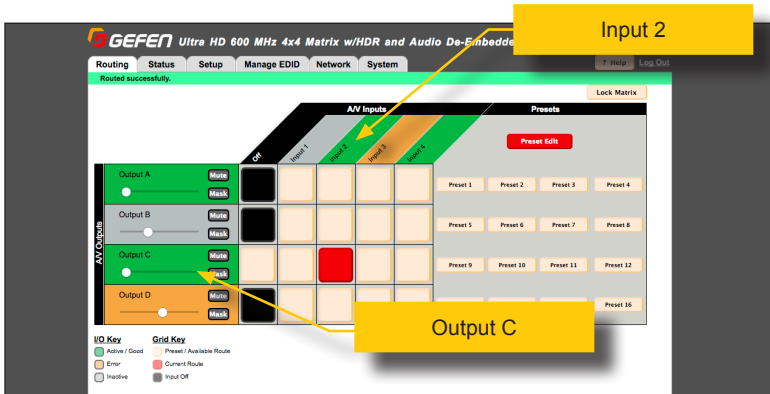

Routing Inputs and Masking Outputs

► Routing Inputs

1. Click the **Routing** tab.
2. Located the desired output, from the rows on the left side of the screen.
3. Click the desired input. Use the column, with the input names, as a guide when selecting the input.

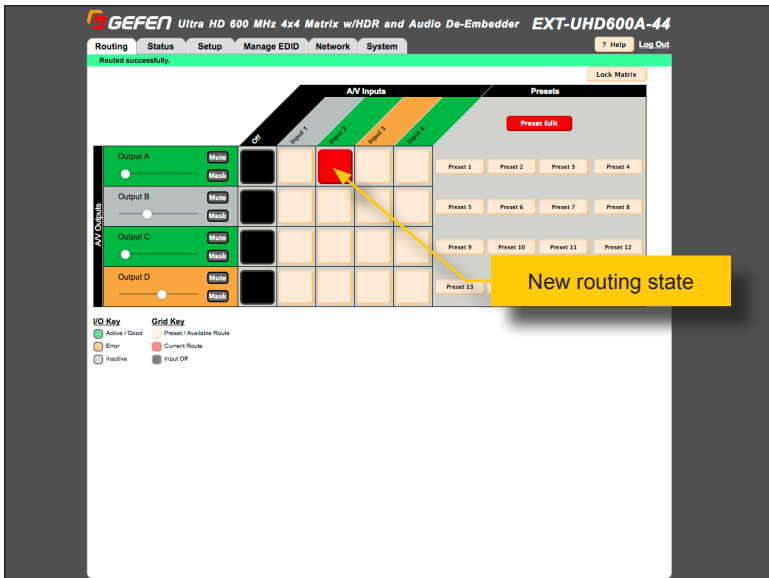

4. Click the square at the intersection of both the output and input.

A *routing indicator* (red square) will appear at the intersection of the row (output) and column (input) of the current routing state.

If the routing process is successful, then a green bar will appear at the top of the page with the text “Routed successfully”..

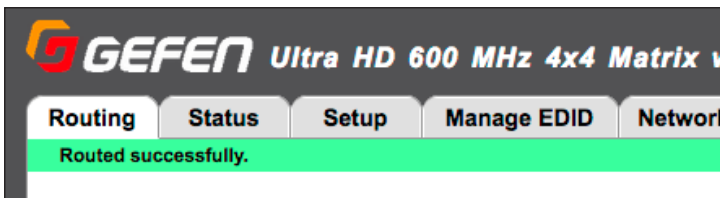

► **Placing an input in the OFF state**

1. Click the box in the first column, next to the desired output.
2. The box, in the column, will turn black, indicating that the input is “off”. The OFF is an additional input that can be selected to simulate a source that is not present.

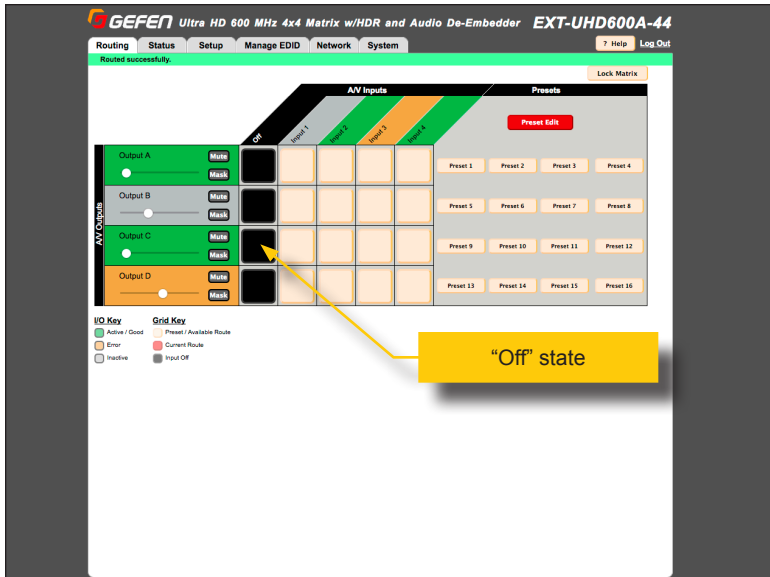

As with any routing operation, if the operation is successful, a green bar will appear at the top of the page with the text “Routed successfully”.

► Masking Outputs

1. Click the **Routing** tab.
2. Mask the desired output by clicking the **Mask** button. The **Mask** button will turn red, indicating that the selected output is masked.

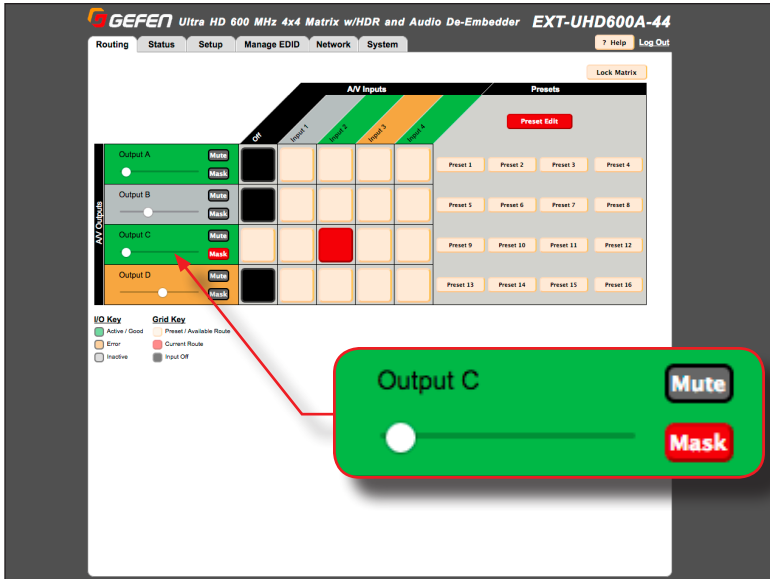

3. To unmask the output, click the **Mask** button again. The button will turn gray.

Routing Presets

► Creating / Editing a Preset

1. Click the **Routing** tab.
2. Under the **Presets** section, click the **Preset Edit** button.

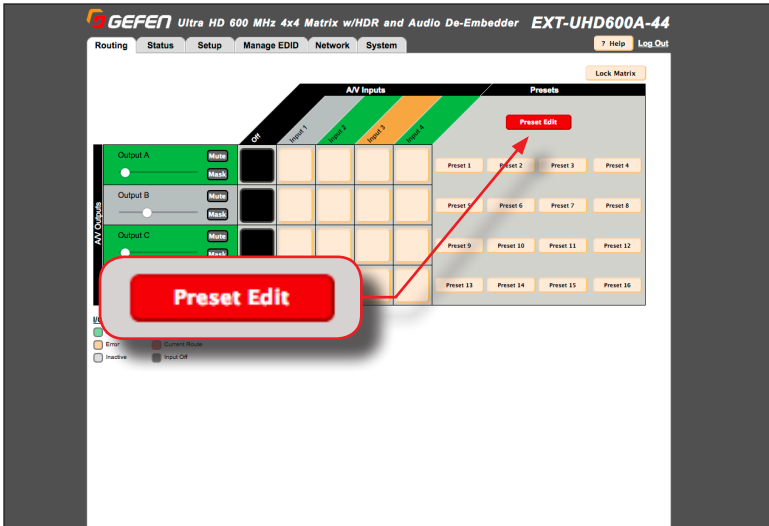

3. The preset buttons will begin to flash and the **Preset Edit** button will read **Choose One**.

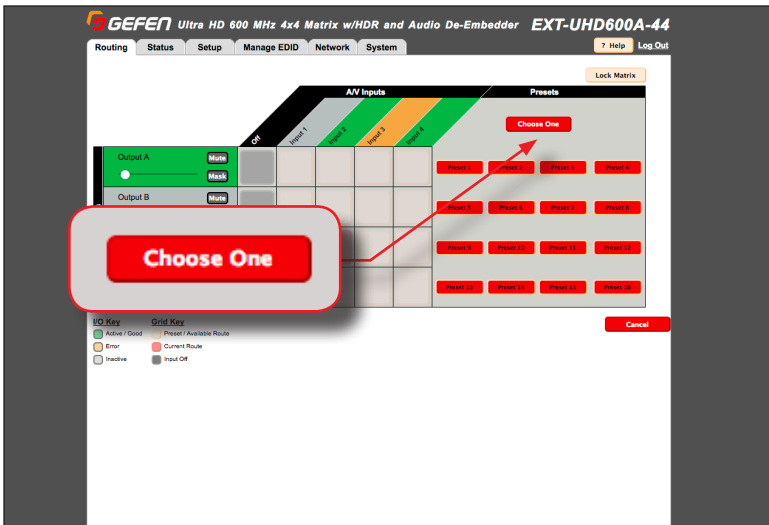

- Click the desired preset to edit.
- The selected preset will be highlighted. In this example, we will select **Preset 6**.

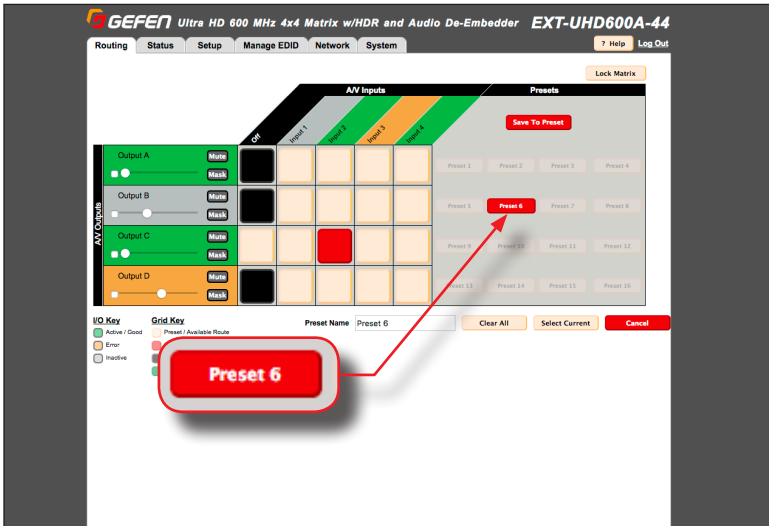

- Select the desired routing state for each input/output. See [Routing Inputs and Masking Outputs](#) (page 31), if necessary. The *preset selections* for the selected preset, will be indicated by a green square, as shown below. Note that an output can also be set to OFF.
- To save the audio volume level for an output, click the check box, next to the volume slider, as shown in the example below.

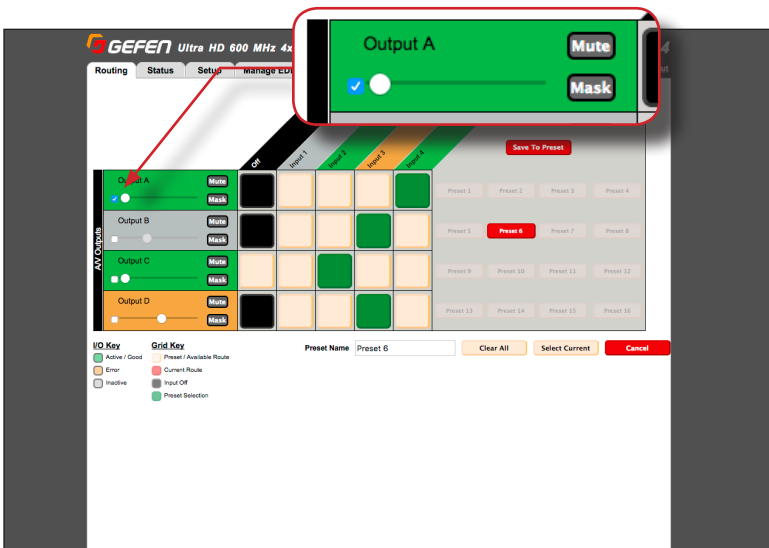

- After the desired routing states, for input/output have been assigned, provide a name for the preset in the **Preset Name** field.

The screenshot displays the GEFEN Ultra HD 600 MHz 4x4 Matrix w/HDR and Audio interface. The main area shows a routing matrix with AV Inputs (Input 1-4) and AV Outputs (Output A-D). A 'Presets' panel on the right lists 16 preset slots, with 'Preset 6' highlighted in red. Below the matrix, a 'Preset Name' field contains the text 'SamplePreset'. At the bottom of the interface, there are three buttons: 'Clear All', 'Select Current', and 'Cancel'. A red callout box at the top right contains the text 'Save To Preset'. Red arrows indicate the flow of interaction: from the 'Save To Preset' callout to the 'Save To Preset' button in the matrix, from the 'Preset Name' field to the 'Preset Name' input, and from the 'Select Current' button to the 'Select Current' button in the matrix.

- ▶ To clear the *preset selections* for the current preset, click the **Clear All** button.
- ▶ To use the current routing state as the preset selection, click the **Select Current** button.
- ▶ To abort the editing of the preset, click the **Cancel** button.

- Click the **Save to Preset** button to save the preset.
- Repeat steps 2 - 8, as desired, for each preset.

▶ Recalling a Preset

- Click the **Routing** tab.
- Click the desired preset button.

Input and Output Status

Provides video and audio information for all inputs and outputs.

1. Click the **Status** tab within the built-in web interface.
2. Information on each input is listed in the top portion of the screen.
3. Information on each output is listed in the bottom portion of the screen.

The screenshot shows the GEFEN web interface for the EXT-UHD600A-44 device. The 'Status' tab is selected. The 'Input' section displays the following data:

Name	Input 1	Input 2	Input 3	Input 4
Color Depth		10 bit		10 bit
Color Space		RGB 4.4.4		RGB 4.4.4
HDR		Yes		Yes
HDCP		2.2		2.2
3D		None		None
Active Signal	No	Yes	No	Yes
Vertical Resolution		3840		3840
Horizontal Resolution		2160		2160
Progressive / Interlaced		P		P
Refresh Rate		60Hz		60Hz
Video Mode		HDMI		HDMI
Audio Input Format		Bluetooth		

The 'Output' section displays the following data:

Name	Output A	Output B	Output C	Output D
RSENSE	High	Low	High	Low
HDP	High	Low	High	Low
HDCP	2.2		2.2	
Video Mode	HDMI			

The table below outlines the information that is available for each section:

Input	Output
<ul style="list-style-type: none"> • Color depth • Color space • HDR • HDCP (version) • 3D (status) • Active Signal • Vertical resolution • Horizontal Resolution • Progressive / interlaced • Refresh rate • Video mode • Audio Format 	<ul style="list-style-type: none"> • Rsense • HDP • HDCP • Video mode

Changing Input and Output Names

By default, the names of each output are **Output A - Output D**. The names of each input are **Input 1 - Input 4**. Each of these names can be changed, as desired, to suit the type of device that is connected to the input or output.



Information

Both input and output names cannot exceed 12 characters in length.

1. Click the **Setup** tab within the built-in web interface.
2. Click the **Names** sub-tab.
3. Click in the field of the desired output or input to be changed.

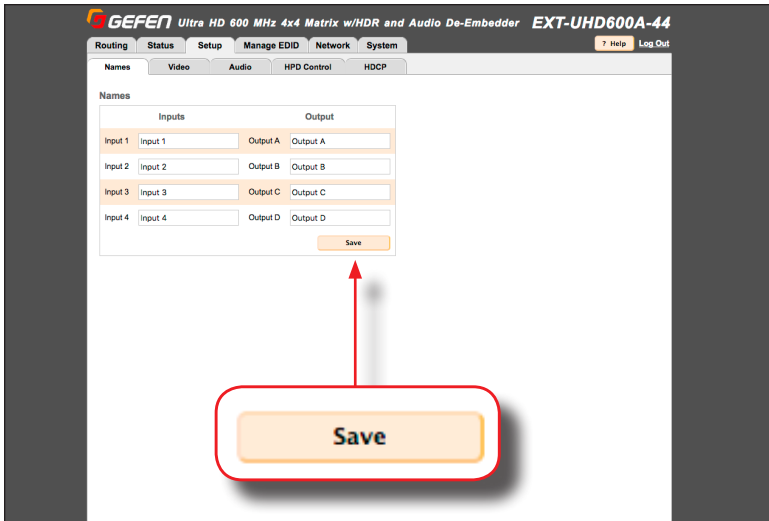

4. Once all changes have been made, click the **Save** button.
5. The new input / output name(s) will be displayed within the **Routing** tab. Note that the new input / output name(s), to the left of each field, will not be changed.

Video

The Video tab handles both video up-scaling and down-scaling.



Important

Scaling is limited to the resolutions listed on under the Video tab. Only 1080p and 4K (3840x2160) signals can be scaled up/down.

1. Click the **Setup** tab within the built-in web interface.
2. Click the **Video** sub-tab.
 - **Output A** and **Output C** provide either **Pass-through** or **1080p down-scaling**.
 - **Output B** and **Output D** provide either **Pass-through** or **2160p up-scaling**.

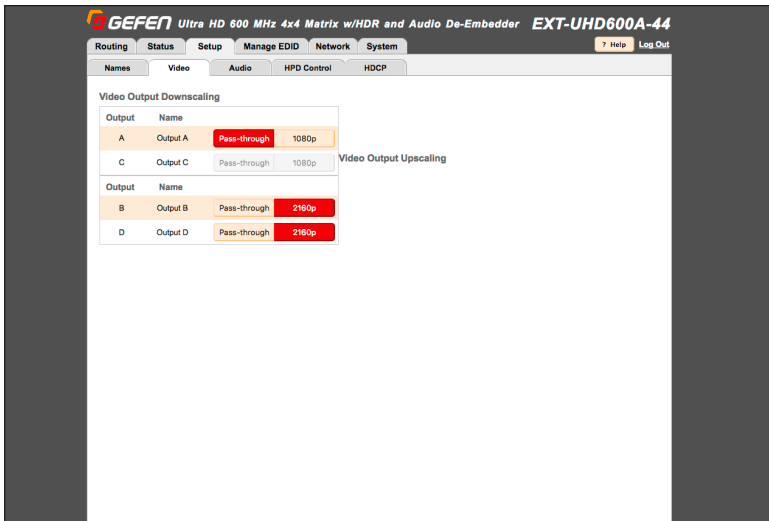

3. Click the desired option. If **Pass-through** is selected, then the source signal will pass-through, unaltered.

If no sink/display device is connected to the output, then all options for that output will be disabled.

Audio

The Audio tab handles how audio is output from the matrix.

1. Click the **Setup** tab within the built-in web interface.
2. Click the **Audio** sub-tab.
3. Click either Fixed or Variable for each output.
 - **Fixed**
In this mode, the matrix will control the audio output level.
 - **Variable**
In this mode, the audio output level of the source will be used.

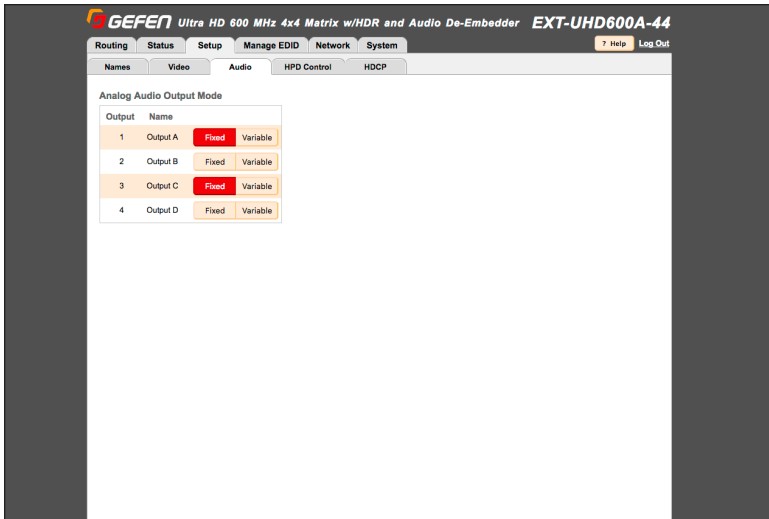

HPD Control

HPD (Hot-Plug Detect) is an HDMI feature which senses if the HDMI cable is disconnected, from the source or sink device, and then re-initializes the HDMI link if necessary. Within the web interface, the HPD pulse can be sent to the selected input, and reset the HDMI connection without disconnecting any cables. The connected display will flash when an HPD signal is received.

1. Click the **Setup** tab within the built-in web interface.
2. Click the **HPD Control** sub-tab.
3. Click the **Pulse** button for the desired input. Click the **Pulse All Inputs** button to send an HPD signal to all inputs.

The screenshot shows the web interface for a Gefen Ultra HD 600 MHz 4x4 Matrix w/HDR and Audio De-Embedder EXT-UHD600A-44. The interface has several tabs: Routing, Status, Setup, Manage EDID, Network, and System. Under the Setup tab, there are sub-tabs: Names, Video, Audio, HPD Control, and HDCP. The HPD Control sub-tab is active, displaying a table with four inputs and a 'Pulse All Inputs' button. A red arrow points from a callout box to the HPD Control section in the main interface.

Input	Name	
1	Input 1	Pulse
2	Input 2	Pulse
3	Input 3	Pulse
4	Input 4	Pulse
		Pulse All Inputs

HDCP

This feature allows HDCP content to either be passed-through or rejected on each input. Outputs can either follow the input status or can be set to always encode HDCP. Note that using the “Reject” feature, on an input, does *not* decrypt HDCP content.

1. Click the **Setup** tab within the built-in web interface.
2. Click the **HDCP** sub-tab.
3. For inputs, select the desired button next to the input.
 - ▶ **Reject** - Does not allow HDCP content to be passed through. Click the **Reject All** button to set all inputs to **Reject**.
 - ▶ **2.2** - Click this button if the sink device supports HDCP 2.2. Click the **All 2.2** button to set all inputs to **2.2**.
 - ▶ **1.4** - Click this button if the sink device only supports HDCP 1.4. Click the **All 1.4** button to set all inputs to **1.4**.

The screenshot shows the GEFEN web interface for the EXT-UHD600A-44. The 'Setup' tab is selected, and the 'HDCP' sub-tab is active. The 'HDCP Handshake' section contains a table with the following data:

Input	Name	Reject	2.2	1.4
1	Input 1	Reject	2.2	1.4
2	Input 2	Reject	2.2	1.4
3	Input 3	Reject	2.2	1.4
4	Input 4	Reject	2.2	1.4
Reject All		All 2.2	All 1.4	

A red arrow points from the 'Reject' button of Input 1 in the screenshot to a larger, detailed view of the 'HDCP Handshake' table below, which is highlighted with a red border. This detailed view shows the same table structure as the screenshot, with the 'Reject' buttons highlighted in red.

4. For outputs, select the desired button next to the output.
- ▶ **Follow Input** - Click this button to have the output follow the setting used on the input. Click the **Follow All** button to set all outputs to **Follow Input**.
 - ▶ **Always Encode** - Encodes the output signal with HDCP 2.2, regardless of the input signal.

Click the **All Encode** button to set all outputs to **Always Encode**.

Output	Name	Follow Input	Always Encode
1	Output A	Follow Input	Always Encode
2	Output B	Follow Input	Always Encode
3	Output C	Follow Input	Always Encode
4	Output D	Follow Input	Always Encode
		All Follow	All Encode

HDCP Handshake

Input	Name	Reject	2.2	1.4
1	Input 1	Reject	2.2	1.4
2	Input 2	Reject	2.2	1.4
3	Input 3	Reject	2.2	1.4
4	Input 4	Reject	2.2	1.4
		Reject All	All 2.2	All 1.4

Output	Name	Follow Input	Always Encode
1	Output A	Follow Input	Always Encode
2	Output B	Follow Input	Always Encode
3	Output C	Follow Input	Always Encode
4	Output D	Follow Input	Always Encode
		All Follow	All Encode



Setting the EDID Mode

The **EDID Mode** tab allows the desired EDID mode (internal preset, external, or custom) to be set for each input.

1. Click the **Manage EDID** tab within the built-in web interface.
2. Click the **EDID Mode** sub-tab.
3. Select the desired EDID mode for each input using the drop-down list.

Input	Input Name	EDID Mode	EDID Name	Lock	EDID Lock
1	Input 1	User-defined	Sony	Lock	Unlocked
2	Input 2	UHD 4k 600 MHz 2ch	Panasonic	Lock	Unlocked
3	Input 3	UHD 4k 300 MHz Multi-Ch	Vizio	Lock	Unlocked
4	Input 4	1080p Multi-Ch	Benc	Lock	Unlocked

If the **EDID Mode** is set to **External**, then the name of the downstream EDID (device) will appear under the EDID Name column, as shown. The **External** modifies the EDID, parsing all outputs to determine optimum compatibility among features for all connected displays.

EDID Mode	EDID Name
External EDID	Sony

► Using a Custom EDID

The **Custom - User-defined** setting is used to store a custom EDID in the selected input. To use a custom EDID, follow the instructions below:

1. Select **Custom - User-defined** from the drop-down list of the desired input.

Input Name	EDID Mode
Input 1	User-defined

2. Copy or upload an EDID to the input that is using the **Custom** mode. See one of the following sections for more information on copying or uploading EDID data:

- [Copying EDID Data \(page 46\)](#).
- [Uploading and Downloading EDID Data \(page 49\)](#).

3. Set the EDID Lock mode to either **Locked** or **Unlocked**:

- **Locked**
Prevents the EDID from being changed on the input..
- **Unlocked**
Allows the EDID to be changed.

	EDID Name	EDID Lock	
<input type="text"/>	Sony	Locked	Unlock
<input type="text"/>	Panasonic	Lock	Unlocked

4. The name of the custom EDID will appear under the **EDID Name** column.

Copying EDID Data

The **EDID Copy** tab allows an EDID to be copied from an input or output (sink device) to any input. In order to copy an EDID to an input, the input must be set to **Custom - User-defined** mode and then unlocked. See [Setting the EDID Mode \(page 44\)](#) for more information.

1. Click the **Manage EDID** tab within the built-in web interface.
2. Click the **EDID Copy** sub-tab.
3. Click the button of the desired output or input from the **Select EDID to Copy** section. Select only one input or output at a time.

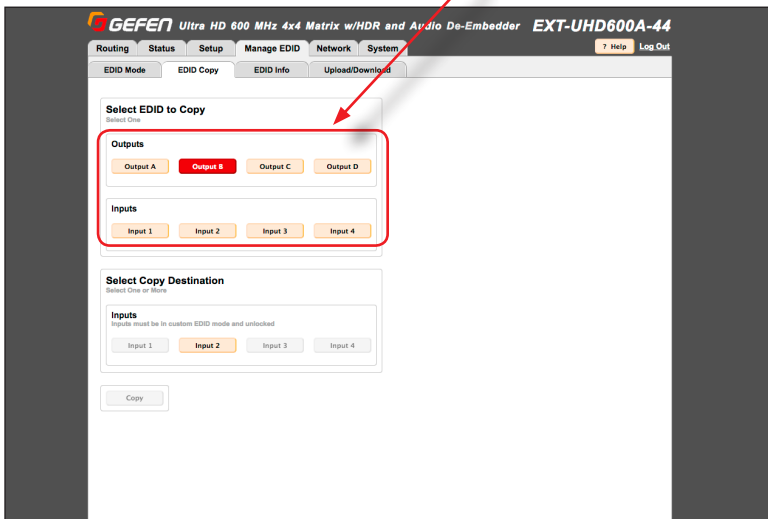
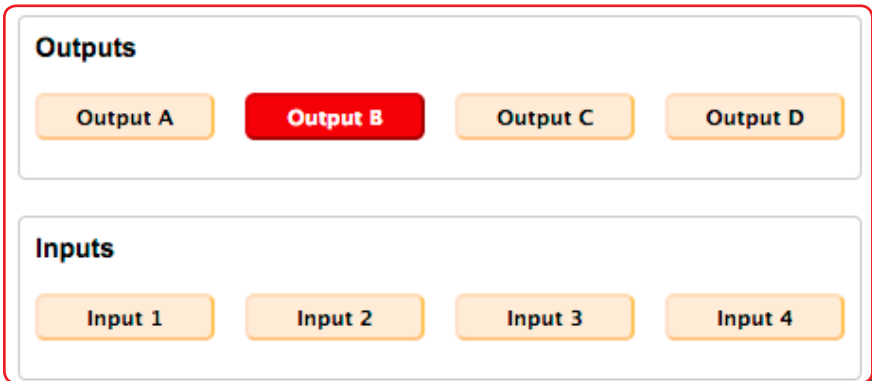

- After the input or output is selected, click the button for the corresponding input where the EDID will be copied. One or more inputs can be selected at a time.

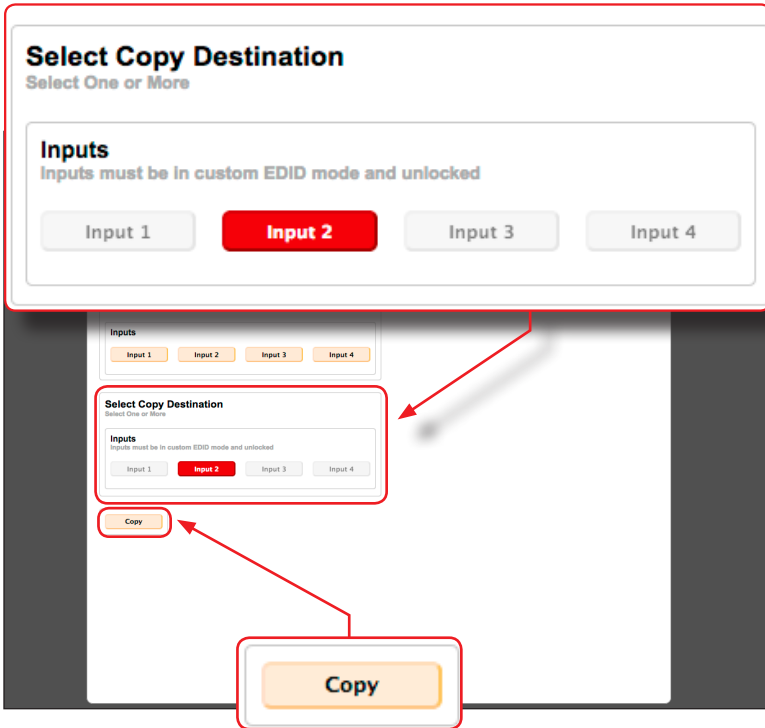

- Click the **Copy** button. The **Copy** can only be pressed when both an output or input (the source) and an input (destination) are selected.
- The EDID copy process is complete. Repeat steps 3 - 5 as desired.



Information

If an Input destination is disabled ("grayed-out"), then this means that the EDID has been "locked" under the EDID Mode sub-tab.

Getting EDID Information

The **EDID Info** tab allows the EDID information, from an input or sink device, to be displayed.

1. Click the **Manage EDID** tab within the built-in web interface.
2. Click the **EDID Info** sub-tab.
3. Select the desired input or output from the **Choose EDID** drop-down list.

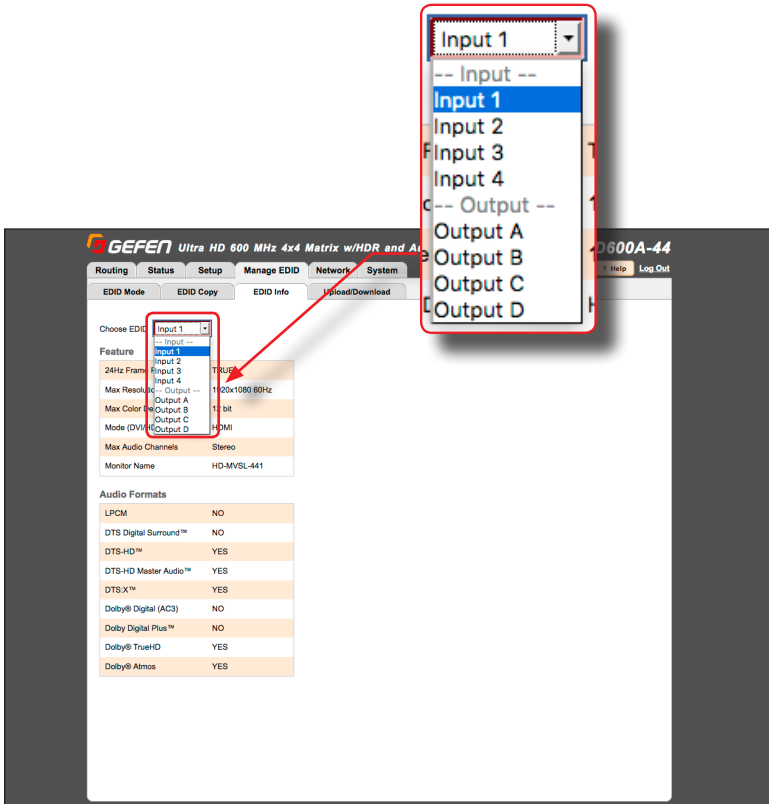

4. The EDID information for the selected input or output will be displayed.

Uploading and Downloading EDID Data

The **Upload / Download** tab allows EDID data from an input, output, or one of the internal EDID presets, to be downloaded and saved as a file on your computer. An EDID file can also be uploaded to any (unlocked) input.

▶ Downloading an EDID

1. Click the **Manage EDID** tab within the built-in web interface.
2. Click the **Upload/Download** sub-tab.
3. Select the desired input, output, or internal EDID preset to be downloaded using the **Select EDID File** drop-down list.
4. Click the **Download** button.

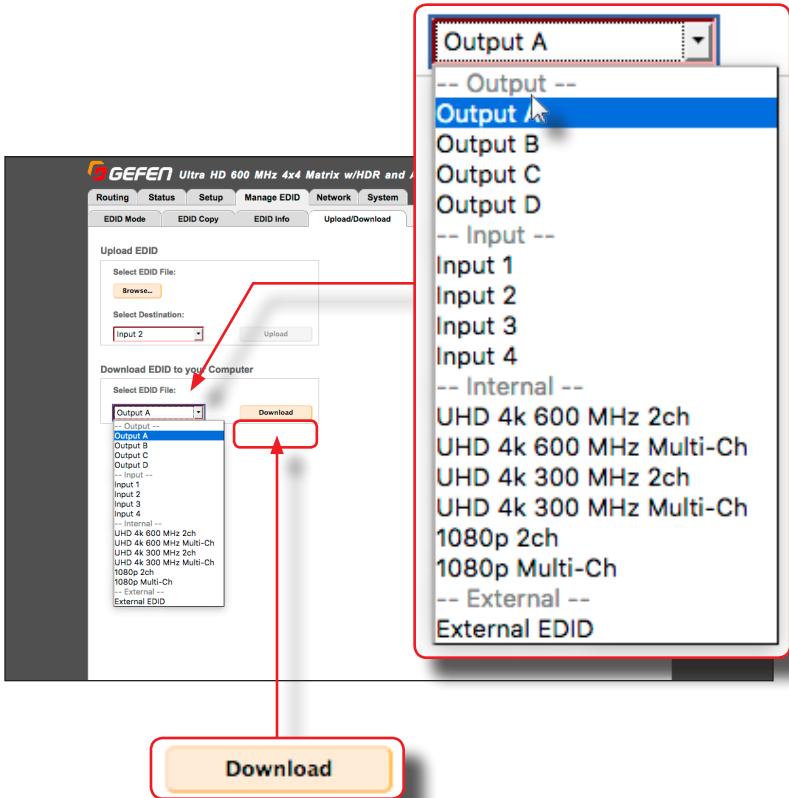

5. The following dialog will be displayed:

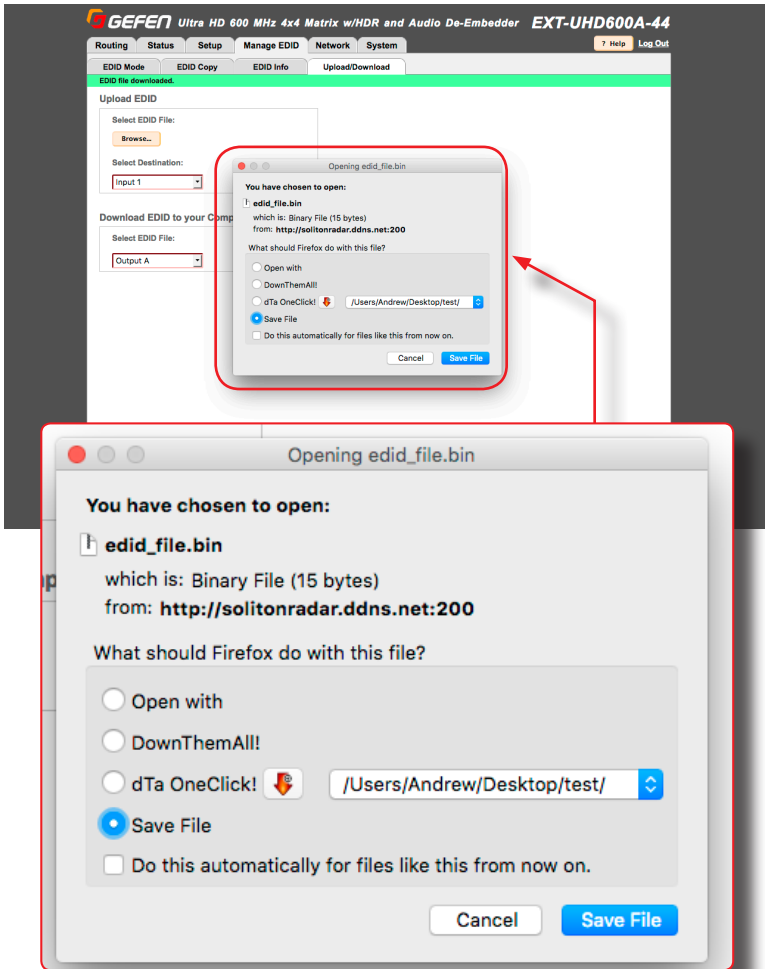

6. Click the **Save File** button to save the EDID file to your computer.
- Mac OS X
The file will automatically be saved under
Macintosh HD\Users\[username]\Downloads.
 - Windows OS
The file will be saved under
C:\Users\[username]\Downloads.

► Uploading an EDID

1. Click the **Manage EDID** tab within the built-in web interface.
2. Click the **Upload/Download** tab.
3. Set the input, where the EDID file will be uploaded, to **Custom** mode. See [Setting the EDID Mode \(page 44\)](#) for more information.
4. Click the **Browse...** button under **Upload EDID** section.
5. The **File Upload** dialog will be displayed.
6. Select the EDID file from your computer. The EDID file must be in **.bin** format. After the file is selected, click the **OK** button on the dialog box.
7. Select the input where the EDID will be uploaded using the **Select Destination** drop-down list. In order for an input to be selected, it must be unlocked and set to **Custom**. Refer to [Setting the EDID Mode \(page 44\)](#) for more information.
8. Click the **Upload** button.

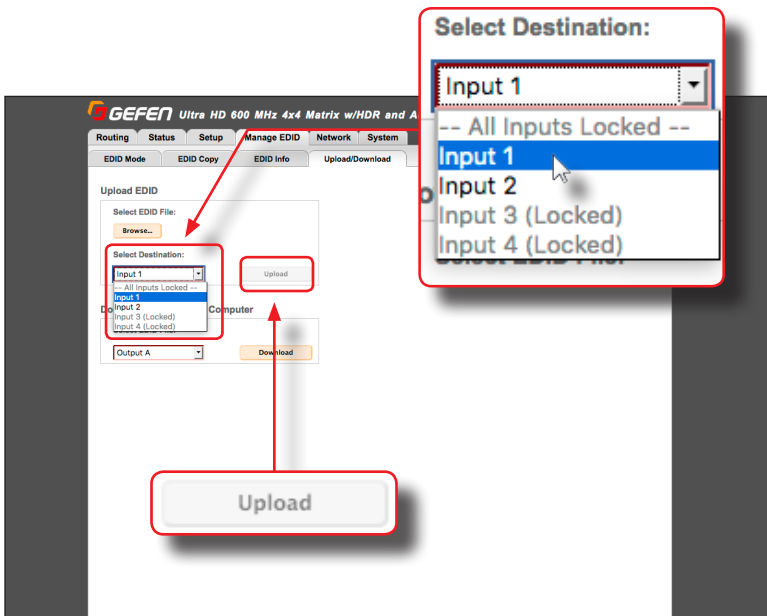

Configuring Network Settings

Once the matrix is configured on the network using Gefen Syner-G, the network settings can be changed within the built-in web interface. To access the network settings, click the **Network** tab in the built-in web interface.

When changing any network setting, click the **Save** button at the bottom of the page. To revert network settings to factory default, click the **Set Network Defaults** button.

► IP Settings

1. Set the network mode by clicking the **Static** or **DHCP** button.
2. If set to **Static** mode, then enter the IP address, subnet mask, and gateway address in the **IP Address**, **Subnet**, and **Gateway** fields, respectively. If set to **DHCP** mode, the DHCP server will assign these values.
3. Enter the HTTP listening port in the **HTTP Port** field.

The screenshot displays the 'Network' configuration page for a Gefen device. The 'IP Settings' section is highlighted with a red box, showing the following values:

IP Address	192.168.1.72
Subnet	255.255.255.0
Gateway	192.168.1.254

Below this, the 'MAC Address' is shown as 00:1C:91:02:20:03 and the 'HTTP Port' is set to 80. The 'Mode' is set to 'Static'.

Other visible settings include:

- TCP/Telnet Settings:** TCP Access (Enabled), TCP Port (23), Login Message on Connect (Show), Require Password on Connect (Enable).
- UDP Settings:** UDP Access (Disabled), Remote UDP Access (Enable), Remote UDP IP Address (192.168.1.129), Remote UDP Port (50008).
- Web Login Settings:** Username, New Password, Discovery Protocol (Enable Discovery), Find Your Device.

Buttons for 'Set Network Defaults' and 'Save' are visible at the bottom of the interface.

► TCP / Telnet Settings

For details on configuring TCP, see [Using Telnet, UDP, and RS-232](#) (page 68).

- **TCP Access:** Click the **Enable** button to allow Telnet access to the matrix. Otherwise, click the **Disable** button.
- **TCP Port:** Enter the TCP listening port in this field.
- **Login Message on Connect:** Click the **Show** button to display the welcome message at the beginning of a Telnet session. Otherwise, click the **Hide** button.
- **Require Password on Connect:** Click the **Enable** button to require password credentials at the beginning of a Telnet session.

The screenshot displays the configuration page for TCP/Telnet settings. A red box highlights the following sections:

- TCP Access:** Enabled (selected), Disable
- TCP Port:** 23
- Login Message on Connect:** Show (selected), Hide
- Require Password on Connect:** Enable (selected), Disabled

The full interface includes the following sections:

- Routing:** Status, Setup, Manage EDID, Network, System
- IP Settings:** MAC Address (00:1C:91:02:20:03), HTTP Port (80), Mode (Static/DHCP), IP Address (192.168.1.72), Subnet (255.255.255.0), Gateway (192.168.1.254)
- TCP/Telnet Settings:** TCP Access, TCP Port, Login Message on Connect, Require Password on Connect, User Name (Admin), Old Password, New Password, Confirm New Password
- UDP Settings:** UDP Access (Enable/Disabled), Remote UDP Access (Enable/Disabled), UDP Port (50007), Remote UDP IP Address (192.168.1.129), Remote UDP Port (50008)
- Web Login Settings:** Username (Operator/Administrator), Old Password, New Password, Confirm New Password
- Discovery Protocol Settings:** Enable Discovery (Enable/Disabled), Discover Read Only (Read Only/Read/Write), Find Your Device (Show Me), Product Description (4x1 HDMI 2.0 True4K Ultra)
- Buttons:** Set Network Defaults, Save

- **User Name:** This field is static and cannot be changed. Telnet sessions are restricted to **Admin** users.
- **Old Password:** Enter the old (current) password in this field. The factory-default password is `admin`.
- **New Password:** Enter the new password in this field.
- **Confirm New Password:** Confirm the new password by entering the new password in this field.



Information

Note that all passwords are case-sensitive.

The screenshot shows the GEFEN web interface with the following settings visible:

- Routing:** 00:1C:91:02:20:43
- IP Settings:**
 - MAC Address: 00:1C:91:02:20:43
 - HTTP Port: 80
 - Mode: Static
 - IP Address: 192.168.1.72
 - Subnet: 255.255.255.0
 - Gateway: 192.168.1.254
- TCP/Telnet Settings:**
 - TCP Access: Enabled
 - TCP Port: 23
 - Login Message on Connect: Show
 - Require Password on Connect: Enabled
 - User Name: Admin
 - Old Password: [Empty]
 - New Password: [Empty]
 - Confirm New Password: [Empty]
- UDP Settings:**
 - UDP Access: Enabled
 - UDP Port: 50007
 - Remote UDP Access: Enabled
 - Remote UDP IP Address: 192.168.1.129
 - Remote UDP Port: 50008
- Web Login Settings:**
 - Username: Operator, Administrator
 - New Password: [Empty]
 - Old Password: [Empty]
 - Confirm New Password: [Empty]
- Discovery Protocol Settings:**
 - Enable Discovery: Enabled
 - Find Your Device: Show Me
 - Discover Read Only: Read Only
 - Product Description: 4x1 HDMI 2.0 True4K Ultra

Buttons at the bottom: Set Network Defaults, Save

► UDP Settings

For details on configuring UDP, see [Using Telnet, UDP, and RS-232](#) (page 68).

- **UDP Access:** Click the **Enable** button to use the UDP protocol with the matrix. Otherwise, click the **Disable** button.
- **UDP Port:** Enter the TCP listening port in this field.
- **Remote UDP Access:** Click the **Enable** button to set the remote UDP address and UDP listening port. This feature only needs to be *enabled* if feedback to the matrix is required. Otherwise, this feature can be *disabled*.

The screenshot displays the 'UDP Settings' section of a web interface. It includes the following fields and controls:

- UDP Access:** A section with 'Enable' and 'Disable' buttons.
- UDP Port:** A text input field containing the value '50007'.
- Remote UDP Access:** A section with 'Enable' and 'Disable' buttons.
- Remote UDP IP Address:** A text input field containing the value '192.168.1.129'.
- Remote UDP Port:** A text input field containing the value '50008'.

A zoomed-in view of the 'Remote UDP Access' section is shown in a separate red-bordered box at the bottom of the image, highlighting the 'Remote UDP Access' buttons, the 'Remote UDP IP Address' field with '192.168.1.129', and the 'Remote UDP Port' field with '50008'.

- **Remote UDP IP Address:** Enter the remote UDP IP address in this field.
- **Remote UDP Port:** Enter the remote UDP listening port in this field.

► Web Login Settings

- **Username:** To change the password for the Administrator, click the **Administrator**. Otherwise, click the **Operator** button.
- **New Password:** Enter password for the selected username (above), in this field. Passwords are case-sensitive.
- **Old Password:** Enter the old (current) password in this field. Passwords are case-sensitive.
- **Confirm New Password:** To confirm the new password, re-enter the new password in this field. Passwords are case-sensitive.

The default password for the **Administrator** username is `admin`.

The default password for the **Operator** username is `operator`.

The screenshot shows the 'Web Login Settings' section of a device's web interface. A red box highlights the 'Username' field, which has 'Operator' and 'Administrator' buttons. Another red box highlights the 'New Password' field. A third red box highlights the 'Old Password' and 'Confirm New Password' fields. A fourth red box highlights the 'Old Password' and 'Confirm New Password' fields in a separate callout box at the bottom of the page.

Web Login Settings

Username: **Operator** **Administrator**

New Password:

Old Password:

Confirm New Password:

Discovery Protocol Settings

Enable Discovery: **Enable** **Disabled**

Discover Read Only: **Read Only** **Read/Write**

Find Your Device: **Show Me**

Product Description: **4x1 HDMI: 2.0 True4K Ultra**

► Discovery Protocol Settings

- Enable Discovery:** Click the **Enable** button to enable “discovery” mode. Otherwise, click the **Disabled** button. In order for Gefen Syner-G to discover the matrix on a network, this feature must be *enabled*.
- Find Your Device:** Click the **Show Me** button to physically locate the matrix on a network. In order for the **Show Me** button to be available, the **Enable Discovery** button must be set to **Enable**. When the **Show Me** button is clicked, the button text will change to **Hide Me** and the buttons, on the front panel, will flash on the front panel of the matrix:



- Discovery Read Only:** When set to **Read Only**, the IP settings for the matrix will be displayed by Syner-G but they cannot be changed. In order to display and change IP settings from within Gefen Syner-G, click the **Read / Write** button.
- Product Description:** EXT-UHD600A-44 is the default product description. This name will be used to identify the matrix when using the Gefen Syner-G software.

The screenshot displays the following settings in the Discovery Protocol Settings section:

- Enable Discovery:** **Enable** (selected), Disabled
- Find Your Device:** Show Me
- Discover Read Only:** Read Only (selected), Read/Write
- Product Description:** 4x1 HDMI 2.0 True4K Ultra

System Settings

The **System** tab provides controls for various other matrix features. Each of these controls is described below.

▶ Main RS-232 Feedback

- Click the **Off** button to disable RS-232 feedback.
- Click the **On** button to enable RS-232 feedback.

▶ LED Brightness

Increases / decreases the brightness of the front-panel display.

- Move the slider to the right to increase the brightness.
- Move the slider to the left to decrease the brightness.

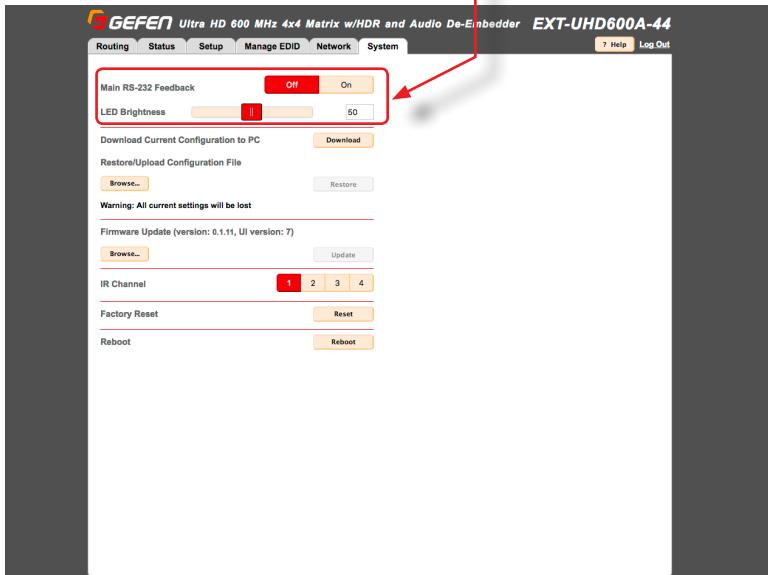
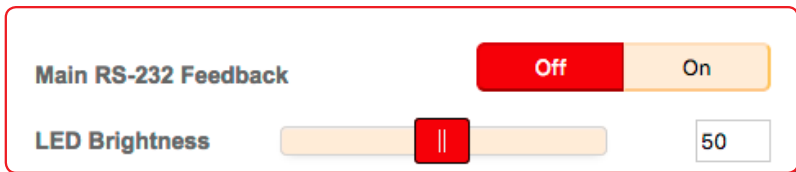

► **Download Current Configuration to PC**

Saves the current matrix configuration to a file on your computer.

1. Click the **Download** button.

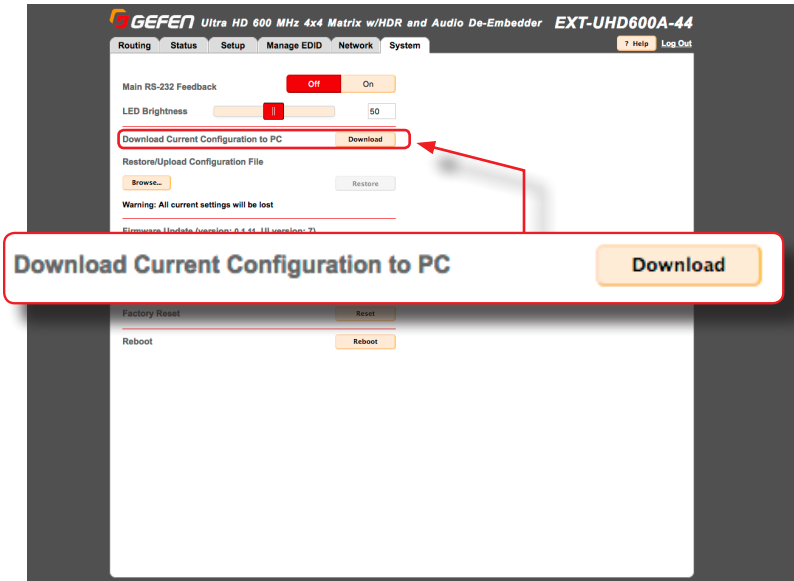

2. The following dialog box will be displayed:

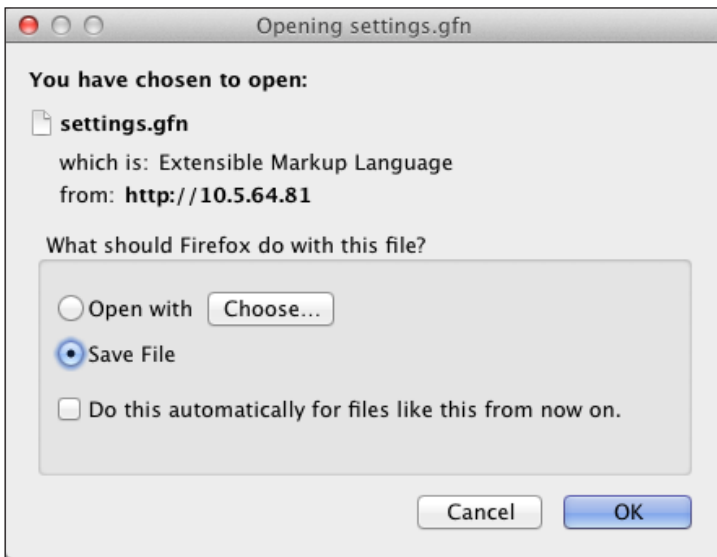

3. Click the **Save File** button to save the configuration file to your computer.

- Mac OS X
The file will automatically be saved under
Macintosh HD\Users\[username]\Downloads
- Windows OS
The file will be saved under
C:\Users\[username]\Downloads

► Restore / Upload Configuration File

Uploads the selected matrix configuration, from a file on your computer, to the matrix.

1. Click the **Browse...** button.

The screenshot shows the GEFEN web interface for the EXT-UHD600A-44 device. The 'System' tab is active. A dialog box titled 'Restore/Upload Configuration File' is open, showing a 'Browse...' button, the filename 'settings.gfn', and a 'Restore' button. A red arrow points from the 'Restore' button in the dialog box to the 'Restore' button in the main interface.

2. Select the desired configuration file from your computer. After the file has been selected, the filename will appear next to the **Browse...** button.

3. Click the **Restore** button to upload the file.

► Firmware Update

Uploads and applies the latest firmware file to the matrix.

1. Download the latest firmware from the Gefen web site.
2. Click the **Browse...** button.

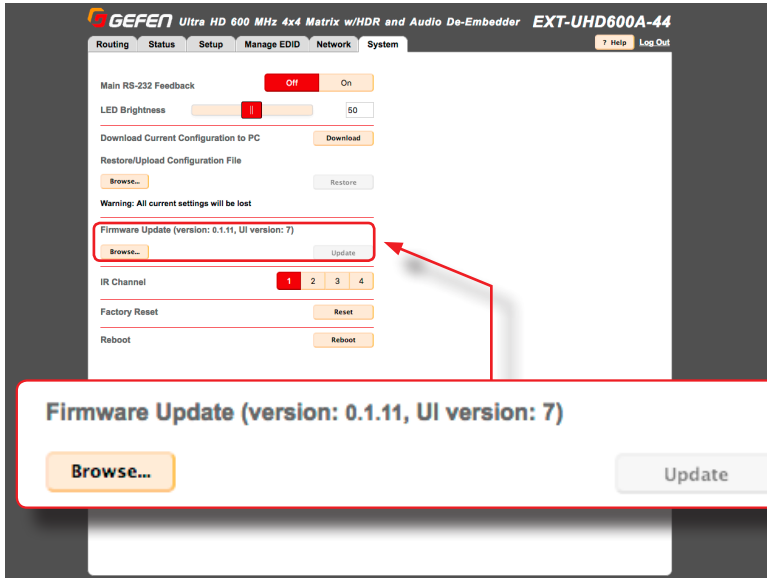

3. Select the firmware file on your computer.

The firmware must be a .bin file and will have the following naming convention: EXT-UHD600A-44 ([version]) (PACK).bin.

4. Click the **Update** button.
5. The following message box will be displayed:

WARNING: Updating the firmware may overwrite some of your settings. Consider saving the configuration before updating the firmware. Are you sure you want to continue?

To save the configuration, before continuing, click the **Cancel** button on the message box. Refer to the section **Download Current Configuration to PC**.

6. Click the **OK** button on the message box.

7. After a few moments, the following message box will be displayed within the web interface:

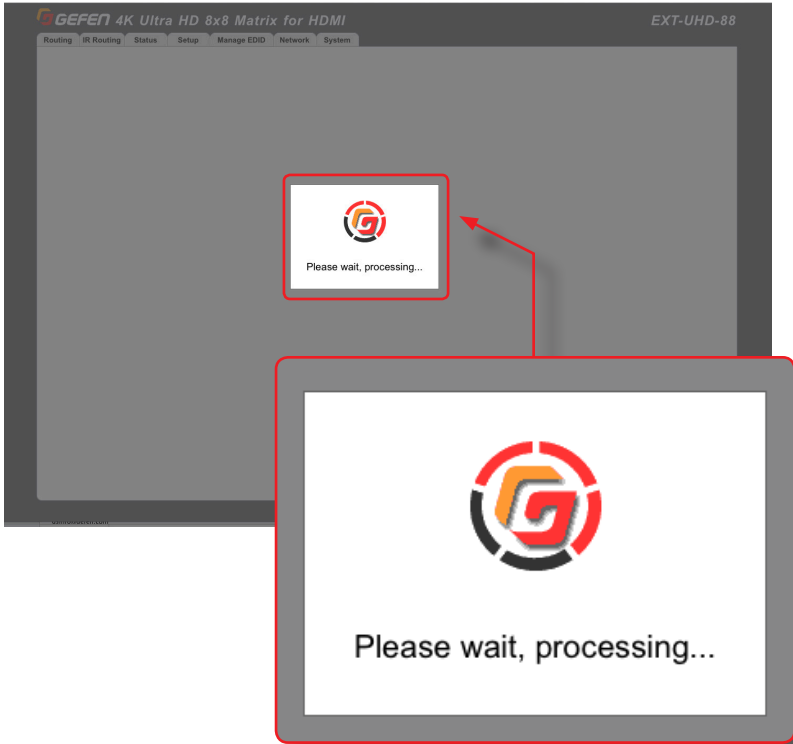

8. After the update process completes, the matrix will automatically reboot.

► Setting the IR Channel

Sets the IR channel for the matrix. The matrix must be set to the same IR channel as the included IR remote control, in order for the IR remote control to communicate with the matrix.

1. Click the desired IR channel for the matrix by clicking one of the **IR Channel** buttons (1 - 4).

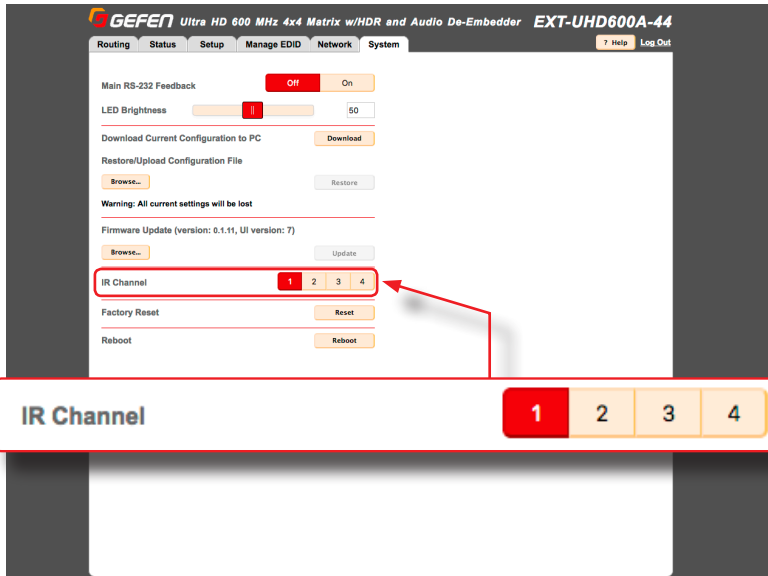

The IR channel setting is automatically saved. Rebooting the matrix is not required.

► Performing a Factory Reset

This feature restores the matrix to original factory-default settings.



Important

Performing this function will erase all current setting in your matrix. IP settings will be retained. To save the configuration, before continuing, refer to the section **Download Current Configuration to PC**.

1. Click the **Reset** button.

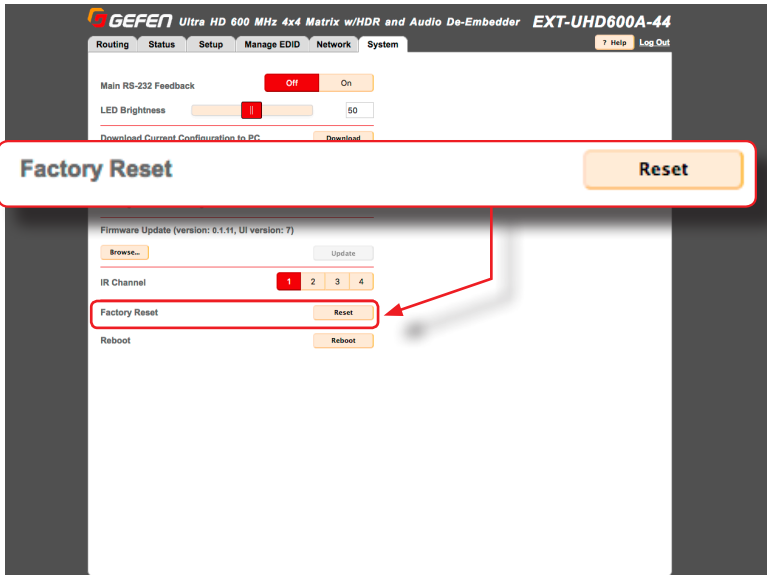

2. The following message box will be displayed:

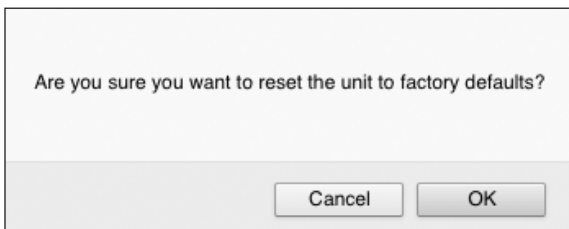

- Click the **OK** button to continue with the reset procedure.
- Click the **Cancel** button to abort the reset procedure and return to the web interface.

► Rebooting the matrix

Clicking this button will reboot the matrix.

1. Click the **Reboot** button.

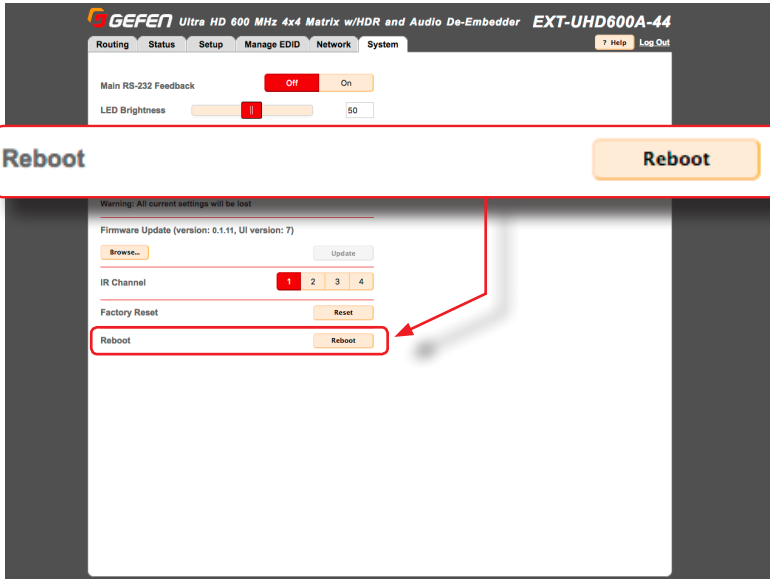

2. The following message box will be displayed:

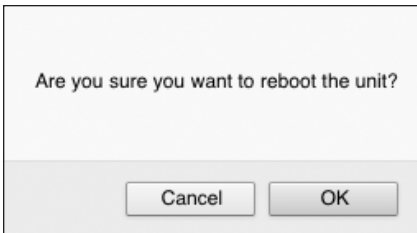

- Click the **OK** button to continue with the reboot procedure.
- Click the **Cancel** button to abort the reboot procedure and return to the web interface.

This page left intentionally blank.

600 MHz
4K ULTRA HD

4x4 Matrix

w/HDR and Audio De-Embedder

3

Advanced Operation

Telnet Configuration

1. Launch the desired terminal application. For example, on the Windows operation system, we can use Hyperterminal; on Mac OS X, we can use the Terminal application.

2. At the command prompt, type the following:

```
telnet ip_address
```

where `ip_address` is the IP address of the matrix.

3. After correct settings have been used in the terminal program, information similar to the following will be displayed:

```
Welcome to EXT-UHD600A-44 Telnet
```

```
telnet->
```

4. Type `#help` for a list of commands or refer to the tables on the following pages.

UDP Configuration

1. Configure the desired control system for UDP.
2. Click the **Network** tab, within the web interface, and do the following. See [Configuring Network Settings \(page 52\)](#) for more information.
 - a. Click the **Enabled** button next to UDP Access.
 - b. Enter the UDP listening port in the **UDP Port** field. The default UDP listening port is 50007.
 - c. Click the **Enabled** button next to **Remote UDP Access**. This feature only needs to be *enabled* if feedback to the matrix is required. Otherwise, this feature can be *disabled*.
 - d. If enabling Remote UDP Access, enter the remote UDP IP address in the **Remote UDP IP Address** field. This IP address should be the same as the control system. The default IP address is 192.168.1.255.
 - e. If enabling Remote UDP Access, enter the remote UDP listening port in the **Remote UDP Port** field. The default remote UDP listening port is 50008.
 - f. Click the **Save** button at the bottom of the **Network** screen.

RS-232 Configuration

1. Selected the desired COM port.
2. Configure the RS-232 port to the following settings. Note that Only TxD, RxD, and GND pins are used.

Description	Setting
Baud rate	19200
Data bits	8
Parity	None
Stop bits	1
Hardware flow control	None

3. Connect to the RS-232 port.
4. Type `#help` for a list of commands or refer to the tables on the following pages.

Discovery Service

Command	Description
#get_device_desc	Returns the current device-description string
#get_discovery	Returns the current state of the discovery service
#get_discovery_mode	Returns the “discovery” mode
#get_showme	Returns the “show me” state
#set_device_desc	Sets the description of the matrix
#set_discovery	Enables or disables the discovery service
#set_discovery_mode	Sets the “discovery” mode
#set_showme	Enables or disables the “show me” feature

Input Status

Command	Description
#gets_input_hdcp	Returns the HDCP setting of the specified input
#gets_input_hpd	Returns the HPD state of the specified input
#gets_input_mode	Returns the video mode of the specified input
#gets_input_signal	Returns the active signal state of the specified input

Manage EDID

Command	Description
#get_custom_edid	Download the custom EDID from the specified input
#get_edid_lock	Returns the EDID-lock status of the specified input
#get_edid_mode	Returns the EDID mode of the specified input
#get_external_edid	Download the modified external EDID
#get_input_edid	Download the current EDID from an input
#get_internal_edid	Downloads a preset internal EDID
#get_output_edid	Downloads a downstream EDID from an input
#send_custom_edid	Uploads a custom EDID to an input
#set_edid_copy	Enables or disables EDID copy
#set_edid_lock	Sets the EDID lock setting on the specified input
#set_edid_mode	Sets the EDID mode on the specified input

Network Settings

Command	Description
#get_gateway	Returns the gateway IP address of the matrix
#get_ip_address	Returns the IP address of the matrix
#get_ip_mode	Returns the IP mode of the matrix
#get_ipconfig	Returns the matrix IP configuration
#get_mac_addr	Returns the MAC address of the matrix
#get_netmask	Returns the subnet mask of the matrix
#get_remote_udp_access	Returns the remote UDP access state of the matrix
#get_remote_udp_ip	Returns the remote UDP IP address of the matrix
#get_remote_udp_port	Returns the remote UDP listening port
#get_telnet_access	Returns the Telnet access state
#get_telnet_login	Returns the current status of the Telnet login process
#get_telnet_message	Returns the Telnet login welcome message status
#get_telnet_port	Returns the Telnet listening port
#get_udp_access	Returns the UDP access state
#get_udp_port	Returns the UDP listening port
#get_web_port	Returns the HTTP listening port
#set_gateway	Sets the gateway address
#set_ip_address	Sets the IP address
#set_ip_mode	Sets the IP mode
#set_netmask	Sets the subnet mask for the matrix
#set_remote_udp_access	Enables or disables remote UDP access
#set_remote_udp_ip	Sets the remote UDP IP address
#set_remote_udp_port	Sets the remote UDP listening port on the matrix
#set_telnet_access	Enables or disables Telnet access
#set_telnet_login	Enables or disables the Telnet login process
#set_telnet_message	Enables or disable the Telnet welcome message
#set_telnet_port	Sets the Telnet listening port on the matrix
#set_udp_access	Enables or disables UDP access
#set_udp_port	Sets the UDP listening port on the matrix
#set_web_port	Sets the HTTP listening port

Output Status

Command	Description
<code>#gets_output_hdcp</code>	Returns the HDCP state of the specified output
<code>#gets_output_hpd</code>	Returns the HPD state of the specified output
<code>#gets_output_mode</code>	Returns the video mode of the specified output
<code>#gets_output_rsense</code>	Returns the output Rsense

Presets

Command	Description
<code>#get_preset_name</code>	Returns the name of the specified preset
<code>#set_preset_name</code>	Sets the name of the specified preset
<code>p</code>	Recalls the specified preset

Routing

Command	Description
<code>#get_mask</code>	Returns the mask status for the specified output(s)
<code>#lock_matrix</code>	Locks or unlocks the matrix
<code>#set_mask</code>	Sets masking on the specified output(s)
<code>r</code>	Routes an input to an output
<code>s</code>	Returns the current routing state for all inputs/outputs

Setup

Command	Description
<code>#get_audio_output</code>	Returns the audio mode for the specified output(s)
<code>#get_input_hdcp</code>	Returns the HDCP handshake more on an input
<code>#get_io_name</code>	Returns the name of the specified input
<code>#get_output_hdcp</code>	Returns the HDCP setting of the specified output
<code>#get_video_scaling</code>	Returns the scaling setting for the specified output
<code>#send_hpd</code>	Sends an HPD signal to the specified input
<code>#set_audio_output</code>	Sets analog audio mode for the specified output(s)
<code>#set_input_hdcp</code>	Sets the HDCP setting on the specified input
<code>#set_io_name</code>	Sets the name of the specified input or output
<code>#set_output_hdcp</code>	Sets the HDCP setting on the specified output
<code>#set_video_scaling</code>	Sets the scaling state for the specified output

System Settings

Command	Description
<code>#factory_reset</code>	Resets the matrix to factory-default settings
<code>#get_button_brightness</code>	Returns the current button brightness value
<code>#get_feedback</code>	Returns the feedback state
<code>#get_firmware_version</code>	Returns the current version of matrix firmware
<code>#get_ir_channel</code>	Returns the current IR channel on the matrix
<code>#get_led_brightness</code>	Returns the current LED brightness setting
<code>#help</code>	Returns a list of available commands
<code>#reboot</code>	Reboots the matrix
<code>#set_button_brightness</code>	Sets the brightness level of the front-panel buttons
<code>#set_feedback</code>	Enables or disables unsolicited RS-232 feedback
<code>#set_ir_channel</code>	Sets the IR channel of the matrix
<code>#set_led_brightness</code>	Sets the brightness of the LED indicators

Volume

Command	Description
<code>#get_mute</code>	Returns the muting status for the specified output(s)
<code>#get_vol</code>	Returns the analog output volume for the output(s)
<code>#set_mute</code>	Sets the audio muting for the specified output(s)
<code>#set_vol</code>	Sets the analog output volume for the output(s)

#factory_reset

Resets the matrix to factory-default settings. If a factory reset is performed through the built-in web interface or Telnet, then IP settings will be preserved. To reset all, including IP settings, this command must be issued using RS-232.

Syntax

```
#factory_reset
```

Parameters

None

Example

```
#factory_reset
RESET TO FACTORY DEFAULTS

EXT-UHD600A-44 V1.00

OUT:ABCD
IN:1234
```

Related Commands

```
#reboot
```

#get_audio_output

Returns the analog audio mode for the specified output(s). The value returned is one of the following:

Type	Description
F	Fixed
V	Variable

Syntax

```
#get_audio_output out
```

Parameters

Parameters

out

Type: **CHAR / INTEGER**

The alphabetic identifier of the output (A - D). Specify 0 to query all outputs; results are returned in output order A - D.

Example

```
#get_audio_output a  
AUDIO_OUTPUT A V
```

Related Commands

```
#set_audio_output
```

#get_button_brightness

Returns the current brightness of the buttons on the front panel of the matrix.

Syntax

```
#get_button_brightness
```

Parameters

None

Example

```
#get_button_brightness  
BUTTON_BRIGHTNESS 50
```

Related Commands

```
#get_led_brightness  
#set_button_brightness  
#set_led_brightness
```

#get_custom_edid

Downloads the customer EDID from the specified input.

Syntax

```
#get_custom_edid input
```

Parameters

Parameters

input

Type: **INTEGER**

The number of the HDMI input (1 - 4).

Example

```
#get_custom_edid 1  
00FFFFFFFFFFFF001CA6000000000000...
```

Related Commands

```
#get_edid_lock  
#get_edid_mode  
#get_external_edid  
#get_input_edid  
#get_internal_edid  
#get_output_edid  
#send_custom_edid  
#set_edid_copy  
#set_edid_lock  
#set_edid_mode
```

#get_device_desc

Returns the description of the matrix.

Syntax

```
#get_device_desc
```

Parameters

None

Example

```
#get_device_desc  
DEVICE DESCRIPTION IS EXT-UHD600A-44
```

Related Commands

```
#set_device_desc
```

#get_discovery

Returns the discovery mode setting. The value returned is one of the following:

Value	Description
0	"Discovery" mode is disabled
1	"Discovery" mode is enabled

Syntax

```
#get_discovery
```

Parameters

None

Example

```
#get_discovery  
DISCOVERY 1
```

Related Commands

```
#set_discovery  
#set_showme
```

#get_discovery_mode

Returns the current “discovery” mode. The value returned is one of the following:

Value	Description
0	Read only
1	Read / Write

Syntax

```
#get_discovery_mode
```

Parameters

None

Example

```
#get_discovery_mode  
#get_discovery_mode 1
```

Related Commands

```
#get_discovery  
#set_discovery  
#set_discovery_mode
```

#get_edid_lock

Returns the current “EDID Lock” state of the specified input. The value returned is one of the following:

Value	Description
0	EDID unlocked
1	EDID locked

Syntax

```
#get_edid_lock input
```

Parameters

input

Type: **INTEGER**

The number of the HDMI input (1 - 4) to query.

Example

```
#get_edid_lock 1  
EDID_LOCK 1 0
```

Related Commands

```
#get_edid_mode  
#set_edid_copy  
#set_edid_lock  
#set_edid_mode
```

#get_edid_mode

Returns the EDID mode of the specified input. The value returned is one of the following:

Value	Description
0	Internal 720p 2Ch
1	Internal 720p Multi-Ch
2	Internal 1080p 2Ch
3	Internal 1080p Multi-Ch
4	Internal UHD 2Ch
5	Internal UHD Multi-Ch
6	External (Output A)
7	Custom

Syntax

```
#get_edid_mode input
```

Parameters

input

Type: **INTEGER**

The number of the HDMI input (1 - 4) to query.

Example

```
#get_edid_mode 1
#get_edid_mode 1 0
```

Related Commands

```
#get_edid_lock
#set_edid_copy
#set_edid_lock
#set_edid_mode
```

#get_external_edid

Returns the modified external EDID.

Syntax

```
#get_external_edid
```

Parameters

None

Example

```
#get_external_edid  
00FFFFFFFFFFFF001CA6000000000000...
```

Related Commands

```
#get_custom_edid  
#get_edid_lock  
#get_edid_mode  
#get_input_edid  
#get_internal_edid  
#get_output_edid  
#send_custom_edid  
#set_edid_copy  
#set_edid_lock  
#set_edid_mode
```

#get_feedback

Returns the feedback status.

Syntax

```
#get_feedback
```

Parameters

None

Example

```
#get_feedback  
FEEDBACK 1
```

Related Commands

```
#factory_reset  
#get_firmware_version  
#get_ir_channel  
#get_led_brightness  
#help  
#reboot  
#set_feedback  
#set_ir_channel  
#set_lcd_brightness
```

#get_firmware_version

Returns the current firmware version of the matrix.

Syntax

```
#get_firmware_version
```

Parameters

None

Example

```
#get_firmware_version  
FIRMWARE VERSION IS 1.0
```

Related Commands

```
#factory_reset  
#get_feedback  
#get_ir_channel  
#get_led_brightness  
#help  
#reboot  
#set_feedback  
#set_ir_channel  
#set_lcd_brightness
```

#get_gateway

Returns the gateway address of the matrix.

Syntax

```
#get_gateway
```

Parameters

None

Example

```
#get_gateway  
GATEWAY 10.5.64.1
```

Related Commands

```
#get_web_port  
#get_ip_address  
#get_ip_mode  
#get_ipconfig  
#get_mac_addr  
#get_netmask  
#set_gateway  
#set_web_port  
#set_ip_address  
#set_ip_mode  
#set_netmask
```

#get_input_edid

Returns the current EDID from the specified input.

Syntax

```
#get_input_edid input
```

Parameters

input

Type: **INTEGER**

The number of the HDMI input (1 - 4) to query.

Example

```
#get_input_edid  
00FFFFFFFFFFFF001CA6000000000000...
```

Related Commands

```
#get_custom_edid  
#get_external_edid  
#get_edid_lock  
#get_edid_mode  
#get_internal_edid  
#get_output_edid  
#send_custom_edid  
#set_edid_copy  
#set_edid_lock  
#set_edid_mode
```

#get_input_hdcp

Returns the HDCP handshake mode of the specified input.

Syntax

```
#get_input_hdcp
```

Parameters

input

Type: **INTEGER**

The number of the HDMI input (1 - 4) to query. Set this parameter to 0 to return the HDCP handshake mode of all inputs in numerical order.

Example

```
#get_input_hdcp 1  
INPUT_HDCP 1 2
```

Related Commands

```
#set_input_hdcp
```

#get_internal_edid

Returns the specified preset internal EDID.

Syntax

```
#get_internal_edid edidps
```

Parameters

edidps

Type: **INTEGER**

The number of the EDID preset.

EDID	Description
1	UHD 600 4K 2CH
2	UHD 600 4K MULTICH
3	UHD 300 4K 2CH
4	UHD 300 4K MULTICH
5	1080P 2CH
6	1080P MULTICH

Example

```
#get_internal_edid 1  
00FFFFFFFFFFFF001CA6000000000000...
```

#get_io_name

Returns the name given to the specified input or output.

Syntax

```
#get_io_name inout
```

Parameters

input

Type: **INTEGER** or **CHARACTER**

The number of the HDMI input (1 - 4) to query.

Example

```
#get_io_name 1  
IO_NAME 1 Bluray
```

Related Commands

```
#set_io_name
```

#get_ip_address

Returns the current IP address of the matrix.

Syntax

```
#get_ip_address
```

Parameters

None

Example

```
#get_ip_address  
IP_ADDRESS 10.5.64.81
```

Related Commands

```
#get_gateway  
#get_web_port  
#get_ip_mode  
#get_ipconfig  
#get_mac_addr  
#get_netmask  
#set_gateway  
#set_web_port  
#set_ip_address  
#set_ip_mode  
#set_netmask
```

#get_ip_mode

Returns the current IP mode of the matrix. The value returned is one of the following:

Value	Description
0	Static mode
1	DHCP mode

Syntax

```
#get_ip_mode
```

Parameters

None

Example

```
#get_ip_mode  
IP_MODE 0
```

Related Commands

```
#get_gateway  
#get_web_port  
#get_ip_address  
#get_ipconfig  
#get_mac_addr  
#get_netmask  
#set_gateway  
#set_web_port  
#set_ip_address  
#set_ip_mode  
#set_netmask
```

#get_ipconfig

Returns the current IP configuration of the matrix. In addition to providing the MAC address and the broadcast IP address, this command also provides the same information as executing the #get_ip_address, #get_netmask, #get_gateway, and #get_mac_addr ommands.

Syntax

```
#get_ipconfig
```

Parameters

None

Example

```
#get_ipconfig
IP CONFIGURATION IS :
IP: 10.5.64.81
NETMASK: 255.255.255.0
GATEWAY: 10.5.64.1
MAC ADDRESS: 00:1C:91:04:90:03
```

Related Commands

```
#get_gateway
#get_web_port
#get_ip_mode
#get_ip_address
#get_mac_addr
#get_netmask
#set_gateway
#set_web_port
#set_ip_address
#set_ip_mode
#set_netmask
```

#get_ir_channel

Returns the IR channel of the matrix.

Syntax

```
#get_ir_channel
```

Parameters

None

Example

```
#get_ir_channel  
IR_CHANNEL 1
```

Related Commands

```
#set_ir_channel
```

#get_led_brightness

Returns the brightness level of the LED indicators on the front panel.

Syntax

```
#get_led_brightness
```

Parameters

None

Example

```
#get_led_brightness  
LED_BRIGHTNESS 60
```

Related Commands

```
#set_led_brightness
```

#get_mac_addr

Returns the MAC address of the matrix.

Syntax

```
#get_mac_addr
```

Parameters

None

Example

```
#get_mac_addr  
MAC ADDRESS IS: 00:1C:91:04:90:03
```

Related Commands

```
#get_gateway  
#get_web_port  
#get_ip_address  
#get_ip_mode  
#get_ipconfig  
#get_netmask  
#set_gateway  
#set_web_port  
#set_ip_address  
#set_ip_mode  
#set_netmask
```

#get_mask

Returns the mask state for the specified output(s).

Syntax

```
#get_mask output
```

Parameters

output

Type: **CHAR / INTEGER**

The alphabetic identifier of the output (A - D). Specify 0 to query all outputs; results are returned in output order A - D.

Example

```
#get_mask a  
MASK A 0
```

Related Commands

#get_mute

Returns the audio muting status for the specified output(s).

Syntax

```
#get_mute output
```

Parameters

output

Type: **INTEGER**

The alphabetic identifier of the output (A - D). Specify 0 to query all outputs; results are returned in output order A - D.

Example

```
#get_mute A  
#get_mute 0
```

Related Commands

#get_netmask

Returns the current subnet mask of the matrix.

Syntax

```
#get_netmask
```

Parameters

None

Example

```
#get_netmask  
NETMASK 255.255.255.0
```

Related Commands

```
#get_gateway  
#get_web_port  
#get_ip_address  
#get_ip_mode  
#get_ipconfig  
#get_mac_addr  
#set_gateway  
#set_web_port  
#set_ip_address  
#set_ip_mode  
#set_netmask
```

#get_output_edid

Returns the downstream EDID from the specified output.

Syntax

```
#get_output_edid output
```

Parameters

output

Type: **CHAR**

The alphabetic identifier of the output (A - D).

Example

```
#get_output_edid a  
00FFFFFFFFFFFF001CA6000000000000...
```

Related Commands

#get_output_hdcp

Returns the HDCP setting of the specified output. The value returned is one of the following:

Value	Description
0	Follow input
1	Always encode

Syntax

```
#get_output_hdcp output
```

Parameters

output

Type: **CHARACTER**

The identifier of the HDMI output (A - D) to query. Specify 0 to query all outputs; results are returned in output order A - D.

Example

```
#get_output_hdcp c  
OUTPUT_HDCP C 1
```

Related Commands

```
#set_output_hdcp
```

#get_preset_name

Returns the name of the specified preset.

Syntax

```
#get_preset_name preset
```

Parameters

preset

Type: **INTEGER**

The identifier of the preset name (1 - 16) to query.

Example

```
#get_preset_name 5  
PRESET_NAME 5 Kitchen
```

Related Commands

```
#set_preset_name
```

#get_remote_udp_access

Returns the remote UDP access state. The value returned is one of the following:

Value	Description
0	Remote UDP access disabled
1	Remote UDP access enabled

Syntax

```
#get_remote_udp_access
```

Parameters

None

Example

```
#get_remote_udp_access  
REMOTE_UDP_ACCESS 0
```

Related Commands

```
#get_remote_udp_ip  
#get_remote_udp_port  
#get_udp_access  
#get_udp_port  
#set_remote_udp_access  
#set_remote_udp_ip  
#set_remote_udp_port  
#set_udp_access  
#set_udp_port
```

#get_remote_udp_ip

Returns the remote UDP IP address.

Syntax

```
#get_remote_udp_ip
```

Parameters

None

Example

```
#get_remote_udp_access  
REMOTE_UDP_IP 192.168.1.255
```

Related Commands

```
#get_remote_udp_access  
#get_remote_udp_port  
#get_udp_access  
#get_udp_port  
#set_remote_udp_access  
#set_remote_udp_ip  
#set_remote_udp_port  
#set_udp_access  
#set_udp_port
```

#get_remote_udp_port

Returns the remote UDP listening port.

Syntax

```
#get_remote_udp_port
```

Parameters

None

Example

```
#get_remote_udp_port  
REMOTE_UDP_PORT 50008
```

Related Commands

```
#get_remote_udp_access  
#get_remote_udp_ip  
#get_udp_access  
#get_udp_port  
#set_remote_udp_access  
#set_remote_udp_ip  
#set_remote_udp_port  
#set_udp_access  
#set_udp_port
```

#get_showme

Returns the “showme” state.

Value	Description
0	Reject
1	HDCP 2.2 and below

Syntax

```
#get_showme
```

Parameters

input

Type: **INTEGER**

The number of the HDMI input (1 - 4) to query.

Example

```
#get_showme
```

Related Commands

#get_telnet_access

Returns the Telnet access state. Use the #set_telnet_access command to enable or disable Telnet access.

Syntax

```
#get_telnet_access
```

Parameters

None

Example

```
#get_telnet_access  
TELNET_ACCESS 1
```

Related Commands

```
#get_telnet_port  
#get_telnet_message  
#set_telnet_access  
#set_telnet_port  
#set_telnet_message
```

#get_telnet_login

Returns the status of the Telnet login process.

Syntax

```
#get_telnet_login
```

Parameters

None

Example

```
#get_telnet_login  
TELNET_LOGIN 0
```

Related Commands

#get_telnet_message

Returns the Telnet welcome message. Use the #set_telnet_message to create a custom welcome message.

Syntax

```
#get_telnet_message
```

Parameters

None

Example

```
#get_telnet_message  
TELNET WELCOME SCREEN IS ENABLED
```

Related Commands

```
#get_telnet_access  
#get_telnet_port  
#set_telnet_access  
#set_telnet_port  
#set_telnet_message
```

#get_telnet_port

Returns the Telnet listening port.

Syntax

```
#get_telnet_port
```

Parameters

None

Example

```
#get_telnet_port  
TELNET_PORT 23
```

Related Commands

```
#get_telnet_access  
#get_telnet_message  
#set_telnet_access  
#set_telnet_port  
#set_telnet_message
```

#get_udp_access

Returns the UDP access state. Use the `#set_udp_access` command to enable or disable UDP access. The value returned is one of the following:

Value	Description
0	UDP access disabled
1	UDP access enabled

Syntax

```
#get_udp_access
```

Parameters

None

Example

```
#get_udp_access  
UDP_ACCESS 0
```

Related Commands

```
#get_remote_udp_access  
#get_remote_udp_ip  
#get_remote_udp_port  
#get_udp_port  
#set_remote_udp_access  
#set_remote_udp_ip  
#set_remote_udp_port  
#set_udp_access  
#set_udp_port
```

#get_udp_port

Returns the local UDP listening port.

Syntax

```
#get_udp_port
```

Parameters

None

Example

```
#get_udp_port  
UDP_PORT 50007
```

Related Commands

```
#get_remote_udp_access  
#get_remote_udp_ip  
#get_remote_udp_port  
#get_udp_access  
#set_remote_udp_access  
#set_remote_udp_ip  
#set_remote_udp_port  
#set_udp_access  
#set_udp_port
```

#get_video_scaling

Returns the current video scaling state. The value returned is one of the following:

Value	Description
0	Scaling disabled
1	Scaling enabled

Syntax

```
#get_video_scaling output
```

Parameters

output

Type: **CHAR / INTEGER**

The alphabetic identifier of the output (A - D). Specify 0 to query all outputs; results are returned in output order A - D.

Example

```
#get_video_scaling a  
VIDEO_SCALING A 1
```

Related Commands

```
#set_video_scaling
```

#get_vol

Returns the analog output volume level for the specified output(s).

Syntax

```
#get_vol output
```

Parameters

output

Type: **CHAR / INTEGER**

The alphabetic identifier of the output (A - D). Specify 0 to query all outputs; results are returned in output order A - D.

Example

```
#get_vol a  
VOL A 100
```

Related Commands

#get_web_port

Returns the HTTP listening port of the matrix.

Syntax

```
#get_web_port
```

Parameters

None

Example

```
#get_web_port  
HTTP_PORT 80
```

Related Commands

```
#get_gateway  
#get_ip_address  
#get_ip_mode  
#get_ipconfig  
#get_mac_addr  
#get_netmask  
#set_gateway  
#set_web_port  
#set_ip_address  
#set_ip_mode  
#set_netmask
```

#gets_input_hdcp

Returns the HDCP mode of the specified input. The value returned is one of the following:

Value	Description
0	Reject
1	HDCP 2.2 and below
2	HDCP 1.4 and below

Syntax

```
#gets_input_hdcp input
```

Parameters

input

Type: **INTEGER**

The number of the HDMI input (1 - 4) to query. Specify 0 to query all inputs; results are returned in input order 1 - 4.

Example

```
#gets_input_hdcp 1  
INPUT_HDCP 1 0
```

Related Commands

```
#get_output_hdcp  
#set_input_hdcp  
#set_output_hdcp
```

#gets_input_hpd

Returns the HPD state of the specified input. The value returned is one of the following:

Value	Description
L	HPD low
H	HPD high

Syntax

```
#gets_input_hpd input
```

Parameters

input

Type: **INTEGER**

The number of the HDMI input (1 - 4) to query. Specify 0 to query all inputs; results are returned in numerical order.

Example

```
#gets_input_hpd 1  
INPUT_HDCP 1 0
```

Related Commands

#gets_input_mode

Returns the video mode of the specified input.

Syntax

```
#gets_input_mode input
```

Parameters

input

Type: **INTEGER**

The number of the HDMI input (1 - 4) to query. Specify 0 to query all inputs; results are returned in input order 1 - 4.

Example

```
#gets_input_mode 1  
INPUT_MODE 1 C
```

Related Commands

#gets_input_signal

Returns the active signal status of the specified input.

Syntax

```
#gets_input_signal input
```

Parameters

input

Type: **INTEGER**

The number of the HDMI input (1 - 4) to query. Specify 0 to query all inputs; results are returned in input order 1 - 4.

Example

```
#gets_input_signal 1  
INPUT_SIGNAL 1 Y
```

#gets_output_hdcp

Returns the HDCP status of the specified output. The value returned will be one of the following:

Value	Description
1	Encrypted (HDCP 1.4)
2	Encrypted (HDCP 2.2)
U	Unencrypted
F	Fail

Syntax

```
#gets_output_hdcp output
```

Parameters

output

Type: **CHAR / INTEGER**

The alphabetic identifier of the output (A - D). Specify 0 to query all outputs; results are returned in output order A - D.

Example

```
#gets_output_hdcp a  
OUTPUT_HDCP A 2
```

#gets_output_hpd

Returns the HPD status of the specified output. The value returned will be one of the following:

Value	Description
L	HPD low
H	HPD high

Syntax

```
#gets_output_hpd output
```

Parameters

output

Type: **CHAR / INTEGER**

The alphabetic identifier of the output (A - D). Specify 0 to query all outputs; results are returned in output order A - D.

Example

```
#gets_output_hpd a  
OUTPUT_HPD A H
```

#gets_output_mode

Returns the video output mode of the specified output. The value returned will be one of the following:

Value	Description
D	DVI signal detected
H	HDMI signal detected

Syntax

```
#gets_output_mode output
```

Parameters

output

Type: **CHAR / INTEGER**

The alphabetic identifier of the output (A - D). Specify 0 to query all outputs; results are returned in output order A - D.

Example

```
#gets_output_mode a  
OUTPUT_MODE A H
```

#gets_output_rsense

Returns the Rsense state of the specified output(s). The value returned will be one of the following:

Value	Description
L	Rsense low
H	Rsense high

Syntax

```
#gets_output_rsense output
```

Parameters

output

Type: **CHAR / INTEGER**

The alphabetic identifier of the output (A - D). Specify 0 to query all outputs; results are returned in output order A - D.

Example

```
#gets_output_rsense a  
OUTPUT_RSENSE A L
```

#help

Returns a list of available commands. The commands listed are specific to either the Sender or Receiver unit.

Syntax

```
#help
```

Parameters

None

Example

```
#help
```

```
[HELP]  
#HELP
```

```
[VOLUME]  
#GET_MUTE  
#GET_VOL  
#SET_MUTE  
#SET_VOL
```

```
[ROUTING]  
#GET_MASK  
#LOCK_MATRIX  
#SET_MASK  
R  
S  
...  
...  
...
```

#lock_matrix

Locks or unlocks the matrix. This command locks the front panel and the built-in web interface of the matrix. Note that if the matrix is locked, settings can still be changed using the command set.

Syntax

```
#lock_matrix state
```

Parameters

state

Type: **INTEGER**

Accepts a number from the table below, specifying the desired state:

state	Description
0	Unlocks the matrix
1	Locks the matrix

Example

```
#lock_matrix 1  
LOCK_MATRIX 1
```

#reboot

Reboots the matrix.

Syntax

```
#reboot
```

Parameters

None

Example

```
#reboot  
UNIT WILL REBOOT SHORTLY
```

Related Commands

```
#factory_reset
```

#send_custom_edid

Uploads a custom EDID to the specified input. The input must first be set to CUSTOM MODE.

Syntax

```
#send_custom_edid input
```

Parameters

input

Type: **INTEGER**

The numeric identifier of the input (1 - 4).

Example

```
#send_custom_edid 1  
SEND_COMPLETE
```

#send_hpd

Sends an HPD (Hot-Plug Detect) pulse to the specified input.

Syntax

```
#send_hpd input
```

Parameters

input

Type: **INTEGER**

The identifier of the HDMI input (1 - 4) where the HPD pulse will be sent. Set this parameter to 0 to send the HPD pulse to all inputs.

Example

```
#send_hpd 1  
HPD SENT
```

#set_audio_output

Sets the analog audio mode for the specified output(s).

Syntax

```
#set_audio_output output audtype
```

Parameters

output

Type: **CHAR / INTEGER**

The alphabetic identifier of the output (A - D). Set this parameter to 0 to set all outputs to the same audio mode (Feedback lists all analog audio modes for outputs in order A - D).

audtype

Type: **CHAR**

The method of how the analog output will be sent to the output. Accepts a value from the table below.

Type	Description
F	Fixed
V	Variable

Example

```
#set_audio_output a f
AUDIO OUTPUT A F
```

Related Commands

```
#get_audio_output
```

#set_button_brightness

Sets the brightness level of the buttons on the front panel of the matrix.

Syntax

```
#set_button_brightness level
```

Parameters

level

Type: **INTEGER**

Accepts a number within the range of 1 - 100.

Example

```
#set_button_brightness 60  
BUTTON_BRIGHTNESS 60
```

Related Commands

```
#get_button_brightness
```

#set_device_desc

Sets the matrix identifier string.

Syntax

```
#set_device_desc name
```

Parameters

name

Type: **STRING**

The device description. This value cannot exceed 30 characters in length.

Example

```
#set_device_desc matrix202  
DEVICE DESCRIPTION IS SET TO matrix202
```

Related Commands

```
#get_device_desc
```

#set_discovery

Enables or disables the “discovery” feature. This feature is *enabled* by default.

Syntax

```
#set_discovery state
```

Parameters

state

Type: **INTEGER**

Accepts a number from the table below, specifying the desired state:

state	Description
0	Disables “Discovery” mode
1	Enables “Discovery” mode

If set to *disabled*, then the Syner-G Software Suite will be unable to detect the matrix on a network. It is recommended that this feature is *enabled*, until the matrix has been configured for use on a network.

Example

```
#set_discovery 0  
DISCOVERY 0
```

Related Commands

```
#get_discovery  
#get_discovery_mode  
#set_discovery_mode
```

#set_discovery_mode

Sets the “discovery” mode. This mode is set to *read/write* by default.

Syntax

```
#set_discovery_mode mode
```

Parameters

mode

Type: **INTEGER**

Accepts a number from the table below, specifying the desired state:

mode	Description
0	Read-only mode
1	Read / write mode

When set to *read-only* mode, the IP settings for the matrix will be displayed within the Gefen Syner-G Software Suite but cannot be changed. In order to both display and allow changes to the IP settings within Gefen Syner-G, set this feature to *read/write* mode.

Example

```
#set_discovery_mode 0  
DISCOVERY MODE 0
```

Related Commands

```
#get_discovery  
#get_discovery_mode  
#set_discovery
```

#set_edid_copy

Copies the EDID from output or input to the selected input for use in custom EDID mode. In order for an EDID to be copied, the destination input port must be set to Custom mode and must not be locked. See [Copying EDID Data \(page 46\)](#) for more information.

Syntax

```
#set_edid_copy inout input [...input]
```

Parameters

inout

Type: **INTEGER** or **CHARACTER**

This parameter can accept either the identifier of an HDMI input (1 - 4) or an HDMI output (A - D). Only a single input or output can be specified at a time.

input

Type: **INTEGER**

This parameter must be the identifier of an HDMI input (1 - 4). Multiple inputs can be specified.

Example

```
#set_edid_copy a 1  
EDID_COPY a 1
```

```
#set_edid_copy b 2 5  
EDID_COPY b 2 5
```

Related Commands

```
#get_edid_lock  
#get_edid_mode  
#set_edid_lock  
#set_edid_mode
```

#set_edid_lock

Locks to unlocks the EDID when using Custom EDID mode. This command only works if the specified input is set to Custom. See the #set_edid_mode command.

Syntax

```
#set_edid_lock input state
```

Parameters

input

Type: **INTEGER**

This parameter must be the identifier of an HDMI input (1 - 4).

state

Type: **INTEGER**

Accepts a number from the table below, specifying the desired state:

state	Description
0	Unlock the EDID
1	Lock the EDID

Example

```
#set_edid_lock 1 0
SET_EDID_LOCK 1 0
```

Related Commands

```
#get_edid_lock
#get_edid_mode
#set_edid_copy
#set_edid_mode
```

#set_edid_mode

Sets the EDID mode for the specified input.

Syntax

```
#set_edid_mode input mode
```

Parameters

input

Type: **INTEGER**

This parameter must be the identifier of an HDMI input (1 - 4).

mode

Type: **INTEGER**

Accepts a number from the table below, corresponding to the desired EDID.

mode	Description
0	Internal 720p 2Ch
1	Internal 720p Multichannel
2	Internal 1080p 2Ch
3	Internal 1080p Multichannel
4	Internal UHD 4K 2Ch
5	Internal UHD 4K Multichannel
6	External (downstream sink)
7	Custom

Example

```
#set_edid_mode 1 0
EDID_MODE 1 0
```

Related Commands

```
#get_edid_lock
#get_edid_mode
#set_edid_copy
#set_edid_lock
```

#set_feedback

Enables or disables unsolicited RS-232 feedback.

Syntax

```
#set_feedback state
```

Parameters

state

Type: **INTEGER**

Accepts a number from the table below, specifying the desired state:

state	Description
0	Disable RS-232 feedback
1	Enable RS-232 feedback

Example

```
#set_feedback 1  
SET_FEEDBACK 1
```

#set_gateway

Sets the gateway address for the matrix. The gateway address will be changed only if the matrix is in *static* IP mode. If the matrix is using *DHCP* mode, then the gateway address is automatically assigned by the DHCP server. The matrix must be rebooted after executing this command.

Syntax

```
#set_gateway addr
```

Parameters

addr

Type: **IP ADDRESS**

The desired gateway address of the matrix. This address must be entered in dot-decimal notation.

Example

```
#set_gateway 10.5.64.1  
GATEWAY 10.5.64.1  
REBOOT TO APPLY SETTINGS
```

Related Commands

```
#get_gateway  
#get_web_port  
#get_ip_address  
#get_ip_mode  
#get_ipconfig  
#get_mac_addr  
#get_netmask  
#set_web_port  
#set_ip_address  
#set_ip_mode  
#set_netmask
```

#set_input_hdcp

Sets the HDCP mode on the specified input.

Syntax

```
#set_input_hdcp input mode
```

Parameters

input

Type: **INTEGER**

Accepts the number of an HDMI input (1 - 4). Set this parameter to 0 to apply the HDCP setting to all inputs (Feedback lists all HDCP settings for inputs in order 1 - 4).

mode

Type: **INTEGER**

Accepts a number from the table below, corresponding to the desired HDCP mode.

mode	Description
0	Reject HDCP content
1	Allow HDCP version 2.2 and below
2	Allow HDCP version 1.4 and below

Example

```
#set_input_hdcp 1
INPUT_HDCP 1 0
```

Related Commands

```
#gets_input_hdcp
#get_output_hdcp
#set_output_hdcp
```

#set_io_name

Sets the name of the specified input.

Syntax

```
#set_io_name inout name
```

Parameters

inout

Type: **INTEGER** or **CHARACTER**

This parameter can accept either the number of an HDMI input (1 - 4) or the identifier or an HDMI output (A - D). Only one input or output can be specified at one time.

name

Type: **STRING**

The desired name of the specified input / output. The length of the string cannot exceed 30 characters. Strings greater than 30 characters in length will be rejected.

Example

```
#set_io_name 1 Bluray  
IO_NAME 1 Bluray
```

```
#set_io_name d BIG_screen  
IO_NAME D BIG_screen
```

Related Commands

```
#get_io_name
```

#set_ip_address

Sets the IP address of the matrix. The matrix must be rebooted after executing this command.

Syntax

```
#set_ip_address addr
```

Parameters

addr

Type: **IP ADDRESS**

The desired IP address of the matrix. This address must be entered in dot-decimal notation.

Example

```
#set_ip_address 10.5.64.81
IP_ADDRESS 10.5.64.81
REBOOT TO APPLY SETTINGS
```

Related Commands

```
#get_gateway
#get_web_port
#get_ip_address
#get_ip_mode
#get_ipconfig
#get_mac_addr
#get_netmask
#set_gateway
#set_web_port
#set_ip_mode
#set_netmask
```

#set_ip_mode

Sets the IP mode of the matrix. The matrix must be rebooted after executing this command.

Syntax

```
#set_ip_mode mode
```

Parameters

mode

Type: **INTEGER**

Accepts a number from the table below, corresponding to the desired IP mode.

mode	Description
0	Static
1	DHCP
2	Auto

Example

```
#set_ip_mode 1
IP MODE 1
REBOOT TO APPLY SETTINGS
```

Related Commands

```
#get_gateway
#get_web_port
#get_ip_address
#get_ip_mode
#get_ipconfig
#get_mac_addr
#get_netmask
#set_gateway
#set_web_port
#set_ip_address
#set_netmask
```

#set_ir_channel

Sets the IR channel of the matrix. In order to use the included IR remote control with the matrix, both the matrix and the IR remote control must be set to the same IR channel.

Syntax

```
#set_ir_channel irch
```

Parameters

irch

Type: **INTEGER**

Accepts a number from the table below, corresponding to the desired IR channel.

irch	Description
1	IR channel 1
2	IR channel 2
3	IR channel 3
4	IR channel 4

Example

```
#set_ir_channel 2  
IR_CHANNEL 2
```

Related Commands

```
#get_ir_channel
```

#set_led_brightness

Sets the brightness level of the LED indicators on the front panel of the matrix.

Syntax

```
#set_led_brightness level
```

Parameters

level

Type: **INTEGER**

Accepts a number within the range of 0 - 100. The value of 100 represents the brightest setting of the display.

Example

```
#set_led_brightness 75  
LED_BRIGHTNESS 75
```

Related Commands

```
#get_led_brightness
```

#set_mask

Sets the masking for the specified output(s).

Syntax

```
#set_mask output state
```

Parameters

output

Type: **CHAR / INTEGER**

The alphabetic identifier of the output (A - D). Set this parameter to 0 to set all outputs to the same masking state (Feedback lists all output masking states in order A - D).

state

Type: **INTEGER**

The masking state. Accepts a value from the table below.

State	Description
0	Unmask
1	Mask

Example

```
#set_mask a 1  
MASK A 1
```

Related Commands

```
#get_mask
```

#set_mute

Sets the audio muting state for the specified output(s).

Syntax

```
#set_mute output
```

Parameters

output

Type: **CHAR / INTEGER**

The alphabetic identifier of the output (A - D). Set this parameter to 0 to set all outputs to the same muting state (Feedback lists all output muting states in order A - D).

state

Type: **INTEGER**

The muting state. Accepts a value from the table below.

State	Description
0	Unmute
1	Mute

Example

```
#set_mute a 0  
MUTE A 0
```

Related Commands

```
#get_mute
```

#set_netmask

Sets the network mask address. The matrix must be rebooted after executing this command.

Syntax

```
#set_netmask addr
```

Parameters

addr

Type: **ADDRESS**

The desired subnet mask of the matrix. This address must be entered in dot-decimal notation.

Example

```
#set_netmask 255.255.255.0
NETMASK 255.255.255.0
REBOOT TO APPLY SETTINGS
```

Related Commands

```
#get_gateway
#get_web_port
#get_ip_address
#get_ip_mode
#get_ipconfig
#get_mac_addr
#get_netmask
#set_gateway
#set_web_port
#set_ip_address
#set_ip_mode
```

#set_output_hdcp

Sets the HDCP mode on the specified output.

Syntax

```
#set_output_hdcp output mode
```

Parameters

output

Type: **CHARACTER**

Accepts the identifier of an HDMI output (A - D). Set this parameter to 0 to set all outputs to the same HDCP mode (Feedback lists all HDCP mode for outputs in order A - D).

mode

Type: **INTEGER**

Accepts a number, from table below, corresponding to the desired HDCP mode.

mode	Description
0	Follow Input
1	Always Encode

Example

```
#set_output_hdcp a 0
OUTPUT_HDCP A 0
```

Related Commands

```
#gets_input_hdcp
#get_output_hdcp
#set_input_hdcp
```

#set_preset_name

Assigns a name to the specified preset.

Syntax

```
#set_preset_name preset name
```

Parameters

preset

Type: **INTEGER**

Accepts the identifier of a Preset (1 - 16).

name

Type: **STRING**

The name of the preset. The name must not exceed 12 characters in length.

No special characters (e.g. #,@,*,&,% , etc.) are allowed. Spaces are permitted.

Example

```
#set_preset_name 1 LivingRoom  
PRESET_NAME 1 LivingRoom
```

Related Commands

```
#get_preset_name
```

#set_remote_udp_access

Enables or disables remote UDP access.

Syntax

```
#set_remote_udp_access state
```

Parameters

state

Type: **INTEGER**

Accepts a number from the table below, corresponding to the desired state.

state	Description
0	Disable remote UDP access
1	Enable remote UDP access

Example

```
#set_remote_udp_access 0  
REMOTE_UDP_ACCESS 0
```

Related Commands

```
#get_remote_udp_access  
#get_remote_udp_ip  
#get_remote_udp_port  
#get_udp_access  
#get_udp_port  
#set_remote_udp_ip  
#set_remote_udp_port  
#set_udp_access  
#set_udp_port
```

#set_remote_udp_ip

Sets the remote UDP IP address of the matrix.

Syntax

```
#set_remote_udp_ip addr
```

Parameters

addr

Type: **IP ADDRESS**

The desired remote UDP IP address of the matrix. The address must be entered in dot-decimal notation.

Example

```
#set_remote_udp_ip 192.168.1.251  
REMOTE_UDP_IP 192.168.1.251
```

Related Commands

```
#get_remote_udp_access  
#get_remote_udp_ip  
#get_remote_udp_port  
#get_udp_access  
#get_udp_port  
#set_remote_udp_access  
#set_remote_udp_port  
#set_udp_access  
#set_udp_port
```

#set_remote_udp_port

Sets the remote UDP listening port for the matrix.

Syntax

```
#set_remote_udp_port port
```

Parameters

port

Type: **INTEGER**

The desired remote UDP port (0 - 65535) of the matrix.

Example

```
#set_remote_udp_port 50008  
REMOTE_UDP_PORT 50008
```

Related Commands

```
#get_remote_udp_access  
#get_remote_udp_ip  
#get_remote_udp_port  
#get_udp_access  
#get_udp_port  
#set_remote_udp_access  
#set_remote_udp_ip  
#set_udp_access  
#set_udp_port
```

#set_showme

Enables or disables the “Show Me” feature. If the “Show Me” feature is enabled, then all the buttons (with the exception of the Power button), will flash slowly. This feature allows the matrix to be visually identified on the network and is useful when multiple matrix units are being used. The default setting is *disabled*.

Syntax

```
#set_showme state
```

Parameters

state

Type: **INTEGER**

Accepts a number from the table below, corresponding to the desired state.

state	Description
0	Disable “Show Me”
1	Enable “Show Me”

Example

```
#set_showme 1  
SET_SHOWME 1
```

Related Commands

```
#get_discovery  
#set_discovery
```

#set_telnet_access

Enables or disables Telnet access on the matrix.

Syntax

```
#set_telnet_access state
```

Parameters

state

Type: **INTEGER**

Accepts a number from the table below, corresponding to the desired state.

state	Description
0	Disable Telnet access
1	Enable Telnet access

Example

```
#set_telnet_access 1  
TELNET_ACCESS 1
```

Related Commands

```
#get_telnet_access  
#get_telnet_port  
#get_telnet_message  
#set_telnet_port  
#set_telnet_message
```

#set_telnet_login

Enable or disable the Telnet login process. When disabled, login credentials are not required.

Syntax

```
#set_telnet_login state
```

Parameters

state

Type: **INTEGER**

Accepts a number, from table below, corresponding to the desired state.

state	Description
0	Disable login process
1	Enable login process

Example

```
#set_telnet_login
```

Related Commands

```
#get_telnet_access  
#get_telnet_port  
#get_telnet_message  
#set_telnet_access  
#set_telnet_message
```

#set_telnet_message

Enables or disables the Telnet welcome message.

Syntax

```
#set_telnet_message state
```

Parameters

state

Type: **INTEGER**

Accepts a number, from table below, corresponding to the desired state.

state	Description
0	Disable welcome message
1	Enable welcome message

Example

```
#set_telnet_message
```

Related Commands

```
#get_telnet_access  
#get_telnet_port  
#get_telnet_message  
#set_telnet_access  
#set_telnet_port
```

#set_telnet_port

Sets the Telnet listening port on the matrix.

Syntax

```
#set_telnet_port port
```

Parameters

port

Type: **INTEGER**

The desired remote Telnet listening port (0 - 65535) of the matrix.

Example

```
#set_telnet_port 23  
TELNET_PORT 23
```

Related Commands

```
#get_telnet_access  
#get_telnet_port  
#get_telnet_message  
#set_telnet_access  
#set_telnet_message
```

#set_udp_access

Enables or disables UDP access.

Syntax

```
#set_udp_access state
```

Parameters

state

Type: **INTEGER**

Accepts a number, from table below, corresponding to the desired state.

state	Description
0	Disable UDP access
1	Enable UDP access

Example

```
#set_udp_access 0  
UDP_ACCESS 0
```

Related Commands

```
#get_remote_udp_access  
#get_remote_udp_ip  
#get_remote_udp_port  
#get_udp_access  
#get_udp_port  
#set_remote_udp_access  
#set_remote_udp_ip  
#set_remote_udp_port  
#set_udp_port
```

#set_udp_port

Sets the local UDP listening port.

Syntax

```
#set_udp_port port
```

Parameters

port

Type: **INTEGER**

The desired UDP listening port (0 - 65535) of the matrix.

Example

```
#set_udp_port 50007
UDP_PORT 50007
```

Related Commands

```
#get_remote_udp_access
#get_remote_udp_ip
#get_remote_udp_port
#get_udp_access
#get_udp_port
#set_remote_udp_access
#set_remote_udp_ip
#set_remote_udp_port
#set_udp_access
```

#set_video_scaling

Enables or disables video scaling for the specified output. Outputs A and C can *downscale* a 2160p source to 1080p. Outputs B and D can *upscale* a 1080p source to 2160p.

Syntax

```
#set_video_scaling output state
```

Parameters

output

Type: **CHAR / INTEGER**

The alphabetic identifier of the output (A - D). Set this parameter to 0 to apply the same scaling setting to all outputs (Feedback lists all scaling settings for outputs in order A - D).

state

Type: **INTEGER**

Accepts a number, from table below, corresponding to the desired state.

state	Description
0	Disable scaling
1	Enable scaling

Example

```
#set_video_scaling a 1
VIDEO_SCALING A 1
```

Related Commands

```
#get_video_scaling
```

#set_vol

Sets the analog output volume level for the specified output(s).

Syntax

```
#set_vol output level
```

Parameters

output

Type: **CHAR / INTEGER**

The alphabetic identifier of the output (A - D). Set this parameter to 0 to set all outputs to the same volume level (Feedback lists all volume levels for outputs in order A - D).

level

Type: **INTEGER**

The desired volume level (0 - 100).

Example

```
#set_vol a 100  
VOL A 100
```

Related Commands

```
#get_vol
```

#set_web_port

Sets the HTTP listening port for the matrix.

Syntax

```
#set_gateway port
```

Parameters

port

Type: **INTEGER**

The desired HTTP listening port for the matrix.

Example

```
#set_gateway 192.168.1.1  
GATEWAY 192.168.1.1
```

Related Commands

```
#get_gateway  
#get_web_port  
#get_ip_address  
#get_ip_mode  
#get_ipconfig  
#get_mac_addr  
#get_netmask  
#set_gateway  
#set_ip_address  
#set_ip_mode  
#set_netmask
```

P

Recalls the specified routing preset.

Syntax

```
p preset
```

Parameters

```
preset
```

Type: **INTEGER**

The number of a preset (1 - 16).

Example

```
p 10  
P 10
```

Related Commands

```
r
```

r

Routes the specified input to the one or more specified outputs.

Syntax

```
r input output [...output]
```

Parameters

input

Type: **INTEGER / CHAR**

The number of an HDMI input (1 - 4). This parameter also accepts a character argument of "X". The "X" argument is not case-sensitive. If "X" is specified, then no input is selected. To "turn on" an input that is marked as "X", use an HDMI input (1 - 4) as the argument.

output

Type: **CHARACTER**

The identifier or an HDMI output (A - D). More than one output may be specified. Set this parameter to 0 to route the `input` to all outputs.

Examples

```
R 1 A
R A 1
```

```
R X A
R A X
```

```
R 1 A B C
R A 1 B 1 C 1
```

```
R 1 0
R A 1 B 1 C 1 D 1
```

Related Commands

[p](#)

S

Returns the routing state for all inputs / outputs. "X" will be displayed when the output is selected to input off.

Syntax

s

Parameters

None

Example

```
s  
S A 1 B 2 C 3 D X
```

Related Commands

r

This page left intentionally blank.

600 MHz
4K ULTRA HD

4x4 Matrix

w/HDR and Audio De-Embedder

4 Appendix

Front of RJ-45 Connector

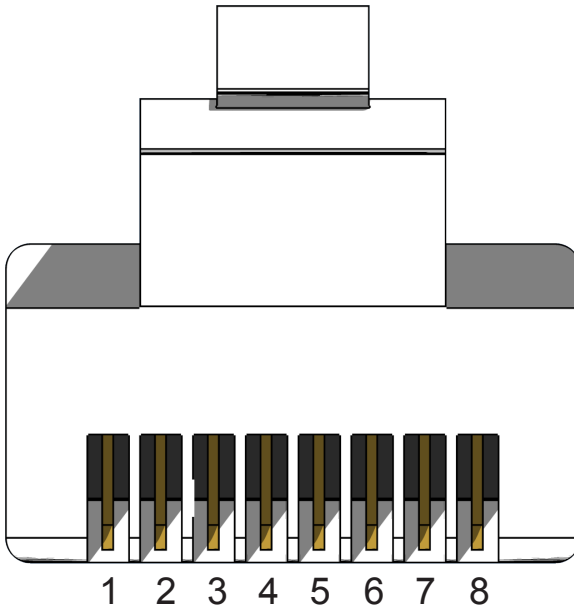

Gefen recommends the TIA/EIA-568-B wiring option. Use the table below when field-terminating cable for use with Gefen products.

Pin	Color	Description
1	Orange / White	TD+ (Transmit Data, positive differential signal)
2	Orange	TD- (Transmit Data, negative differential signal)
3	Green / White	RD+ (Receive Data, positive differential signal)
4	Blue	Unused
5	Blue / White	Unused
6	Green	RD- (Receive Data, negative differential signal)
7	Brown / White	Unused
8	Brown / White	Unused



Information

Shielded CAT-5e (or better) cabling is recommended.

Description	Setting
MAC Address	Device-dependent (cannot be modified)
IP Address	192.168.1.72
Subnet Mask	255.255.255.0
Default Gateway	192.168.1.1
HTTP Listening Port	80
Telnet Listening Port	23
Telnet / TCP Access	Enabled
UDP Port	50007
Enable UDP Access	Disabled
Remote UDP IP Address	192.168.1.255
Remote UDP Port	50008
Remote UDP Access	Disabled
Default Administrator Password	Admin
Default Operator Password	Operator
Gefen Syner-G Discovery	Enabled
Gefen Syner-G Discovery Mode	Read / Write
Gefen Syner-G Show Device	Hide Me

Description	Setting
Output Names	Output A - Output D
A/V Input Names	Input 01 - Input 04
HDCP (each input)	Version 2.2 and below
HDCP (each output)	Follow Input
EDID (each input)	Internal UHD 4K 600Mhz 2Ch
RS-232 Feedback	On
LED Brightness	50
IR Channel	1
Routing	Input 01 > Output A Input 02 > Output B Input 03 > Output C Input 04 > Output D
Preset Names	Preset01 - Preset16
Matrix Lock	Disabled

720p 2-channel audio

Video data block

```
1280x720p @ 60Hz (16:9)
1280x720p @ 50Hz (16:9)
640x480p @ 60Hz (4:3)
720x480p @ 60Hz (16:9)
720x480p @ 60Hz (4:3)
1440x480p @ 60Hz (4:3)
1440x480p @ 60Hz (16:9)
720x576p @ 50Hz (4:3)
1440x480i @ 60Hz (4:3)
1440x480i @ 60Hz (16:9)
720x576p @ 50Hz (16:9)
1440x576i @ 50Hz (4:3)
1440x576i @ 50Hz (16:9)
1440x576p @ 50Hz (4:3)
1440x576p @ 50Hz (16:9)
```

Audio data block

Linear PCM

Max channels: 2

Supported sample rates (kHz): 48 44.1 32

Supported sample sized (bits): 24 20 16

720p Multichannel audio

Video data block

```
640x480p @ 60Hz (4:3)
720x480p @ 60Hz (4:3)
720x480p @ 60Hz (4:3)
1280x720p @ 60Hz (native)
1440x480i @ 60Hz (4:3)
720x576p @ 50Hz (4:3)
720x576p @ 50Hz (16:9)
1280x720p @ 50Hz (16:9)
1440x576i @ 50Hz (4:3)
```

Audio data block

Linear PCM

Max channels: 2

Supported sample rates (kHz): 48 44.1 32

Supported sample sized (bits): 24 20 16

1080p 2-channel audio

Video data block

```
640x480p @ 60Hz (4:3)
720x480p @ 60Hz (16:9)
720x480p @ 60Hz (16:9)
1280x720p @ 60Hz (16:9)
1920x1080i @ 60Hz (16:9)
1440x480i @ 60Hz (4:3)
1440x480i @ 60Hz (16:9)
1440x480p @ 60Hz (4:3)
1440x480p @ 60Hz (16:9)
720x576p @ 50Hz (4:3)
720x576p @ 50Hz (16:9)
1280x720p @ 50Hz (16:9)
1920x1080i @ 50Hz (16:9)
1440x576i @ 50Hz (4:3)
1440x576i @ 50Hz (16:9)
1440x576p @ 50Hz (4:3)
1440x576p @ 50Hz (16:9)
1920x1080p @ 50Hz (16:9)
1920x1080p @ 24Hz (16:9)
1920x1080p @ 25Hz (16:9)
1920x1080p @ 30Hz (16:9)
1920x1080i @ 50Hz (16:9)
1280x720p @ 24Hz (16:9)
1280x720p @ 25Hz (16:9)
1280x720p @ 30Hz (16:9)
1920x1080p @ 60Hz (16:9)
```

Audio data block

Linear PCM

Max channels: 2

Supported sample rates (kHz): 48 44.1 32

Supported sample sized (bits): 24 20 16

1080p Multichannel audio

Video data block

```

640x480p @ 60Hz (4:3)
720x480p @ 60Hz (16:9)
720x480p @ 60Hz (16:9)
1280x720p @ 60Hz (16:9)
1920x1080i @ 60Hz (16:9)
1440x480i @ 60Hz (4:3)
1440x480i @ 60Hz (16:9)
1440x480p @ 60Hz (4:3)
1440x480p @ 60Hz (16:9)
720x576p @ 50Hz (4:3)
720x576p @ 50Hz (16:9)
1280x720p @ 50Hz (16:9)
1920x1080i @ 50Hz (16:9)
1440x576i @ 50Hz (4:3)
1440x576i @ 50Hz (16:9)
1440x576p @ 50Hz (4:3)
1440x576p @ 50Hz (16:9)
1920x1080p @ 50Hz (16:9)
1920x1080p @ 24Hz (16:9)
1920x1080p @ 25Hz (16:9)
1920x1080p @ 30Hz (16:9)
1920x1080i @ 50Hz (16:9)
1280x720p @ 24Hz (16:9)
1280x720p @ 25Hz (16:9)
1280x720p @ 30Hz (16:9)
1920x1080p @ 60Hz (16:9)

```

Audio data block

Linear PCM

Max channels: 2

Supported sample rates (kHz): 192 176.4 96 88.2 48 44.1 32

Supported sample sizes (bits): 24 20 16

Linear PCM

Max channels: 8

Supported sample rates (kHz): 48 44.1 32

Supported sample sizes (bits): 24 20 16

DTS

Max channels: 6

Supported sample rates (kHz): 48 44.1

Maximum bit rate: 0 kHz

AC-3

Max channels: 6

Supported sample rates (kHz): 48 44.1 32

Maximum bit rate: 640 kHz

Enhanced AC-3

Max channels: 8

Supported sample rates (kHz): 48 44.1

4K 2-channel audio

Video data block

```
720x480p @ 60Hz
1280x720p @ 60Hz (16:9)
1920x1080i @ 60Hz (16:9)
1440x480i @ 60Hz (16:9)
1920x1080p @ 60Hz (16:9)
720x576p @ 50Hz (16:9)
1280x720p @ 50Hz (16:9)
1920x1080i @ 50Hz (16:9)
1440x576i @ 50Hz (16:9)
1920x1080p @ 50Hz (16:9)
1920x1080p @ 24Hz (16:9)
1920x1080p @ 25Hz (16:9)
1920x1080p @ 30Hz (16:9)
3840x2160p @ 24Hz (16:9)
3840x2160p @ 25Hz (16:9)
3840x2160p @ 30Hz (16:9)
3840x2160p @ 50Hz (16:9)
3840x2160p @ 60Hz (16:9)
4096x2160p @ 24Hz (256:135)
4096x2160p @ 25Hz (256:135)
4096x2160p @ 30Hz (256:135)
4096x2160p @ 50Hz (256:135)
4096x2160p @ 60Hz (256:135)
```

Audio data block

Linear PCM

Max channels: 2

Supported sample rates (kHz): 192 176.4 96 88.2 48 44.1 32

Supported sample sizes (bits): 24 20 16

4K multichannel audio

Video data block

```

720x480p @ 60Hz
1280x720p @ 60Hz (16:9)
1920x1080i @ 60Hz (16:9)
1440x480i @ 60Hz (16:9)
1920x1080p @ 60Hz (16:9)
720x576p @ 50Hz (16:9)
1280x720p @ 50Hz (16:9)
1920x1080i @ 50Hz (16:9)
1440x576i @ 50Hz (16:9)
1920x1080p @ 50Hz (16:9)
1920x1080p @ 24Hz (16:9)
1920x1080p @ 25Hz (16:9)
1920x1080p @ 30Hz (16:9)
3840x2160p @ 24Hz (16:9)
3840x2160p @ 25Hz (16:9)
3840x2160p @ 30Hz (16:9)
3840x2160p @ 50Hz (16:9)
3840x2160p @ 60Hz (16:9)
4096x2160p @ 24Hz (256:135)
4096x2160p @ 25Hz (256:135)
4096x2160p @ 30Hz (256:135)
4096x2160p @ 50Hz (256:135)
4096x2160p @ 60Hz (256:135)

```

Audio data block

Linear PCM

Max channels: 2

Supported sample rates (kHz): 48 44.1 32

Supported sample sizes (bits): 24 20 16

Linear PCM

Max channels: 8

Supported sample rates (kHz): 96 48 44.1

Supported sample sizes (bits): 24 20 16

AC-3

Max channels: 6

Supported sample rates (kHz): 48

Maximum bit rate: 640 kHz

Enhanced AC-3

Max channels: 8

Supported sample rates (kHz): 192 96 48 44.1

MAT (MLP)

Max channels: 1

Supported sample rates (kHz): 192 96 48 44.1

DTS

Max channels: 6

Supported sample rates (kHz): 96 48 44.1

Maximum bit rate: 1536 kHz

DTS-HD

Max channels: 8

Supported sample rates (kHz): 192 96 48

Supported Formats	
Resolutions (max.)	<ul style="list-style-type: none"> • 4096 x 2160 at 60 Hz (4:4:4) • 3860 x 2160 at 60 Hz (4:4:4) • 1080p Full HD • 1920 x 1200 (WUXGA)

Connectors, Controls, and Indicators	
HDMI Input Connectors	<ul style="list-style-type: none"> • 4 x Type A 19-pin female, locking
HDMI Output Connectors	<ul style="list-style-type: none"> • 4 x Type A 19-pin female, locking
Digital Audio Output Connectors	<ul style="list-style-type: none"> • 4 x TOSLINK® Optical • 4 x RCA Coaxial
Analog L/R Audio Output Connectors	<ul style="list-style-type: none"> • 4 x 3.5mm mini-stereo jack
RS-232 serial port	<ul style="list-style-type: none"> • 1 x DB-9, female
Ethernet (IP Control)	<ul style="list-style-type: none"> • 1 x RJ-45
Power Indicator	<ul style="list-style-type: none"> • 1 x LED, blue
Input Indicators	<ul style="list-style-type: none"> • 16 x LED, blue • 4 x LED, red
Input Selector Buttons	<ul style="list-style-type: none"> • 4 x tact-type
Reset Button	<ul style="list-style-type: none"> • 1 x tact-type, recessed
IR Sensor	<ul style="list-style-type: none"> • 1 x located on front panel
IR In/Ext Port	<ul style="list-style-type: none"> • 1 x 3.5mm mini-stereo jack
IR Extender type	<ul style="list-style-type: none"> • EXT-RMT-EXTIRN
DC Power Connector	<ul style="list-style-type: none"> • 1 x 4-pin, locking
Power Supply	<ul style="list-style-type: none"> • 24V DC

Operational	
Maximum TMDS Clock	<ul style="list-style-type: none"> • 600 MHz
Total Signal Bandwidth / Data Rate	<ul style="list-style-type: none"> • 18 Gbps
HDMI Out 1 and 2 pin 18 current capability	<ul style="list-style-type: none"> • 500 mA at 5V
USB power ports current capability	<ul style="list-style-type: none"> • 2 A total at 5V DC (shared)
Power Consumption	<ul style="list-style-type: none"> • 40 W, USB power ports in use • 30 W, USB power ports not used
Operating Temperature	<ul style="list-style-type: none"> • +32 to +122 °F (0 to +50 °C)
Operating Humidity	<ul style="list-style-type: none"> • 5% to 90% RH, non-condensing
Storage temperature	<ul style="list-style-type: none"> • -4 to +185 °F (-20 to +85 °C)
Storage humidity	<ul style="list-style-type: none"> • 0% to 95% RH, non-condensing
MTBF	<ul style="list-style-type: none"> • 50000 hours

Physical	
Rack-mount requirements	<ul style="list-style-type: none">• Standard 19" rack, 1U high
Dimensions (excluding rack ears and connectors, W x H x D)	<ul style="list-style-type: none">• 17.25" x 1.75" x 6.3" (440mm x 45mm x 160mm)
Net Unit Weight	<ul style="list-style-type: none">• 3.5 lbs (1.5 kg)
Shipping Weight	<ul style="list-style-type: none">• 6.0 lbs (2.7 kg)

Features and specifications are subject to change without notice.

All trademarks and registered trademarks are the property of their respective owners.

Copyright© 2017 Core Brands, LLC.

This page left intentionally blank.



1800 S McDowell Blvd. Petaluma CA 94954
(707) 283-5900 (800) 472-5555