



4K ULTRA HD

8x8 Matrix for HDMI

GTB-HD4K2K-848-BLK
User Manual



Release A5

Important Safety Instructions

1. Read these instructions.
2. Keep these instructions.
3. Heed all warnings.
4. Follow all instructions.
5. Do not use this unit near water.
6. Clean only with a dry cloth.
7. Do not block any ventilation openings. Install in accordance with the manufacturer's instructions.
8. Do not install or place this unit near any heat sources such as radiators, heat registers, stoves, or other apparatus (including amplifiers) that produce heat.
9. Do not defeat the safety purpose of the polarized or grounding-type plug. A polarized plug has two blades with one wider than the other. A grounding type plug has two blades and a third grounding prong. The wide blade or the third prong are provided for your safety. If the provided plug does not fit into your outlet, consult an electrician for replacement of the obsolete outlet.
10. Protect the power cord from being walked on or pinched particularly at plugs, convenience receptacles, and the point where they exit from the unit.
11. Only use attachments/accessories specified by the manufacturer.
12. To reduce the risk of electric shock and/or damage to this unit, never handle or touch this unit or power cord if your hands are wet or damp. Do not expose this unit to rain or moisture.
13. Unplug this unit during lightning storms or when unused for long periods of time.
14. Refer all servicing to qualified service personnel. Servicing is required when the unit has been damaged in any way, such as power-supply cord or plug is damaged, liquid has been spilled or objects have fallen into the unit, the unit has been exposed to rain or moisture, does not operate normally, or has been dropped.
15. Batteries that may be included with this unit and/or accessories should never be exposed to open flame or excessive heat. Always dispose of used batteries according to the instructions.

Warranty Information

Gefen warrants the equipment it manufactures to be free from defects in material and workmanship.

If equipment fails because of such defects and Gefen is notified within two (2) years from the date of shipment, Gefen will, at its option, repair or replace the equipment, provided that the equipment has not been subjected to mechanical, electrical, or other abuse or modifications. Equipment that fails under conditions other than those covered will be repaired at the current price of parts and labor in effect at the time of repair. Such repairs are warranted for ninety (90) days from the day of reshipment to the Buyer.

This warranty is in lieu of all other warranties expressed or implied, including without limitation, any implied warranty or merchantability or fitness for any particular purpose, all of which are expressly disclaimed.

1. Proof of sale may be required in order to claim warranty.
2. Customers outside the US are responsible for shipping charges to and from Gefen.
3. Copper cables are limited to a 30 day warranty and cables must be in their original condition.

The information in this manual has been carefully checked and is believed to be accurate. However, Gefen assumes no responsibility for any inaccuracies that may be contained in this manual. In no event will Gefen be liable for direct, indirect, special, incidental, or consequential damages resulting from any defect or omission in this manual, even if advised of the possibility of such damages. The technical information contained herein regarding the features and specifications is subject to change without notice.

For the latest warranty coverage information, refer to the Warranty and Return Policy under the Support section of the Gefen Web site at www.gefen.com.

Technical Support

(818) 772-9100 (800) 545-6900
8:00 AM to 5:00 PM Monday - Friday, Pacific Time

Fax

(818) 772-9120

Email

support@gefen.com

Web

<http://www.gefen.com>

Mailing Address

Gefen, LLC
c/o Customer Service
20600 Nordhoff St.
Chatsworth, CA 91311

Product Registration

Register your product here: <http://www.gefen.com/kvm/Registry/Registration.jsp>

- EDID contains the A/V capabilities of a display device in regards to video resolutions and audio formats supported. This information is used by the source device to determine the format of the A/V signal on the outputs. The 4K Ultra HD 8x8 Matrix for HDMI incorporates advanced EDID management to ensure compatibility with all sources and display devices.
- The 4K Ultra HD 8x8 Matrix for HDMI can detect the presence of Deep Color (12-bit signal) automatically and will disable Deep Color EDID features across all other outputs if any connected device or display is not capable of processing Deep Color. This automatic behavior ensures compatibility among all output devices in a mixed-device environment. This feature cannot be disabled.
- When powering the 4K Ultra HD 8x8 Matrix for HDMI or if the EDID mode is changed, the 4K Ultra HD 8x8 Matrix for HDMI will undergo a momentary initialization sequence. This is normal and may take a few seconds.
- The best way to operate and configure this unit is to use the built-in Web interface, which can be accessed by entering the IP address of the matrix into the address bar of any Web browser. See the section [Web Interface \(page 104\)](#) for more information about this feature.

4K Ultra HD 8x8 Matrix for HDMI is a trademark of Gefen, LLC.

© 2015 Gefen, LLC. All Rights Reserved. All trademarks are the property of their respective owners.

Gefen, LLC reserves the right to make changes in the hardware, packaging, and any accompanying documentation without prior written notice.



This product uses UL or CE listed power supplies.

This product uses software that is subject to open source licenses, including one or more of the General Public License Version 2 and Version 2.1, Lesser General Public License Version 2.1 and Version 3, BSD, and BSD-style licenses. Distribution and use of this product is subject to the license terms and limitations of liability provided in those licenses. Specific license terms and Copyright Notifications are provided in the source code.

For three years from date of activation of this product, any party may request, and we will supply, for software covered by an applicable license (e.g. GPL or LGPL), a complete machine-readable copy of the corresponding open source code on a medium customarily used for software interchange. The following software and libraries are included with this product and subject to their respective open source licenses:

- lwIP
- jQuery

lwIP is licenced under the BSD licence:

Copyright (c) 2001-2004 Swedish Institute of Computer Science.
All rights reserved.

Redistribution and use in source and binary forms, with or without modification, are permitted provided that the following conditions are met:

1. Redistributions of source code must retain the above copyright notice, this list of conditions and the following disclaimer.
2. Redistributions in binary form must reproduce the above copyright notice, this list of conditions and the following disclaimer in the documentation and/or other materials provided with the distribution.
3. The name of the author may not be used to endorse or promote products derived from this software without specific prior written permission.

THIS SOFTWARE IS PROVIDED BY THE AUTHOR "AS IS" AND ANY EXPRESS OR IMPLIED WARRANTIES, INCLUDING, BUT NOT LIMITED TO, THE IMPLIED WARRANTIES OF MERCHANTABILITY AND FITNESS FOR A PARTICULAR PURPOSE ARE DISCLAIMED. IN NO EVENT SHALL THE AUTHOR BE LIABLE FOR ANY DIRECT, INDIRECT, INCIDENTAL, SPECIAL, EXEMPLARY, OR CONSEQUENTIAL DAMAGES (INCLUDING, BUT NOT LIMITED TO, PROCUREMENT OF SUBSTITUTE GOODS OR SERVICES; LOSS OF USE, DATA, OR PROFITS; OR BUSINESS INTERRUPTION) HOWEVER CAUSED AND ON ANY THEORY OF LIABILITY, WHETHER IN CONTRACT, STRICT LIABILITY, OR TORT (INCLUDING NEGLIGENCE OR OTHERWISE) ARISING IN ANY WAY OUT OF THE USE OF THIS SOFTWARE, EVEN IF ADVISED OF THE POSSIBILITY OF SUCH DAMAGE.

Features and Packing List

Features

- Routes eight 4K Ultra HD sources to eight displays
- Supports resolutions up to 4K (DCI) (4096 x 2160 @ 24 or 30Hz 4:4:4), 4K Ultra HD (3860 x 2160 @ 60 Hz 4:2:0 or 30Hz 4:4:4), 1080p Full HD, and 1920x1200 (WUXGA)
- HDMI 2.0 compliant
- HDCP 1.4 compliant
- Supports 12-bit Deep Color (up to 1080p Full HD)
- 3D pass-through
- Lip Sync pass-through
- Push button controls for Routing and Status
- Advanced EDID Management for rapid integration of sources and displays
- Supports LPCM 7.1, Dolby® TrueHD, Dolby® Digital Plus, and DTS-HD Master Audio™
- Supports the use of DVI sources and DVI displays with HDMI-to-DVI adapters (not included)
- RS-232 Serial interface for remote control via a computer or automation control system
- IP control via Telnet, UDP, and the built-in web server interface
- IR remote control
- Gefen Syner-G™ software's Discovery and Show-Me features simplify initial IP configuration
- Field-upgradeable firmware via web server interface
- Surface-mountable

HDMI® 2.0

4K ULTRA HD
60Hz, 4:2:0

4K CINEMA
DCI, 4096 x 2160, 30Hz

3D
SUPPORT

HDCP

1080P
PROGRESSIVE

7.1
Audio

Advanced
EDID
Management

Deep Color Support

IP
Control

Packing List

The 4K Ultra HD 8x8 Matrix for HDMI ships with the items listed below. If any of these items are not present in the box when you first open it, immediately contact your dealer or Gefen.

- 1 x 4K Ultra HD 8x8 Matrix for HDMI
- 1 x IR Remote
- 1 x 24V DC Power Supply
- 1 x AC Power Cord
- 1 x Quick-Start Guide

This page left intentionally blank.

1 Getting Started

Introduction.....	2
Matrix	2
IR Remote Control	5
Installing the IR Remote Battery	7
Setting the IR Remote Channel	7
Installation	8
Connection Instructions.....	8
Sample Wiring Diagram	9

2 Basic Operation

Routing Basics	12
Main Display.....	12
Determining the Current Routing State	13
Selecting Sources and Outputs.....	14
Locking the Matrix	17
Fast Switching Technology	18
Fast / Slow Switching Modes	19
IR Control	21
Setting the IR Channel.....	21
Using the IR Remote.....	23
Using the IR Extender.....	25
EDID Management.....	26
External EDID Management	26

3 Advanced Operation

IP Configuration.....	30
Using Syner-G™	30
RS-232 Configuration.....	32
RS-232 Interface	32
RS-232 Settings	32
Commands.....	33
Web Interface	104
Using the built-in Web Server	104
Main > Routing	105
Main > I/O Status	108
Main > Display Info.....	110
I/O Setup > Preset Names	111
I/O Setup > I/O Names.....	112
I/O Setup > HPD Control.....	113
I/O Setup > FST	114
I/O Setup > HDCP.....	115

Manage EDID > Assign	116
Manage EDID > Bank Names	119
Manage EDID > Upload/Download	120
Configuration > Change IP Settings	122
Configuration > Telnet Login Settings	123
Configuration > UDP Connection Settings	124
Configuration > Web Login Settings	125
Configuration > System Configuration	126

4 Appendix

Mounting Instructions	130
Firmware Upgrade Procedure	131
Upgrading using the Web interface	131
Upgrading using the USB port	132
Specifications	133

This page left intentionally blank.

4K Ultra HD 8x8 Matrix for HDMI

1

Getting Started

Matrix



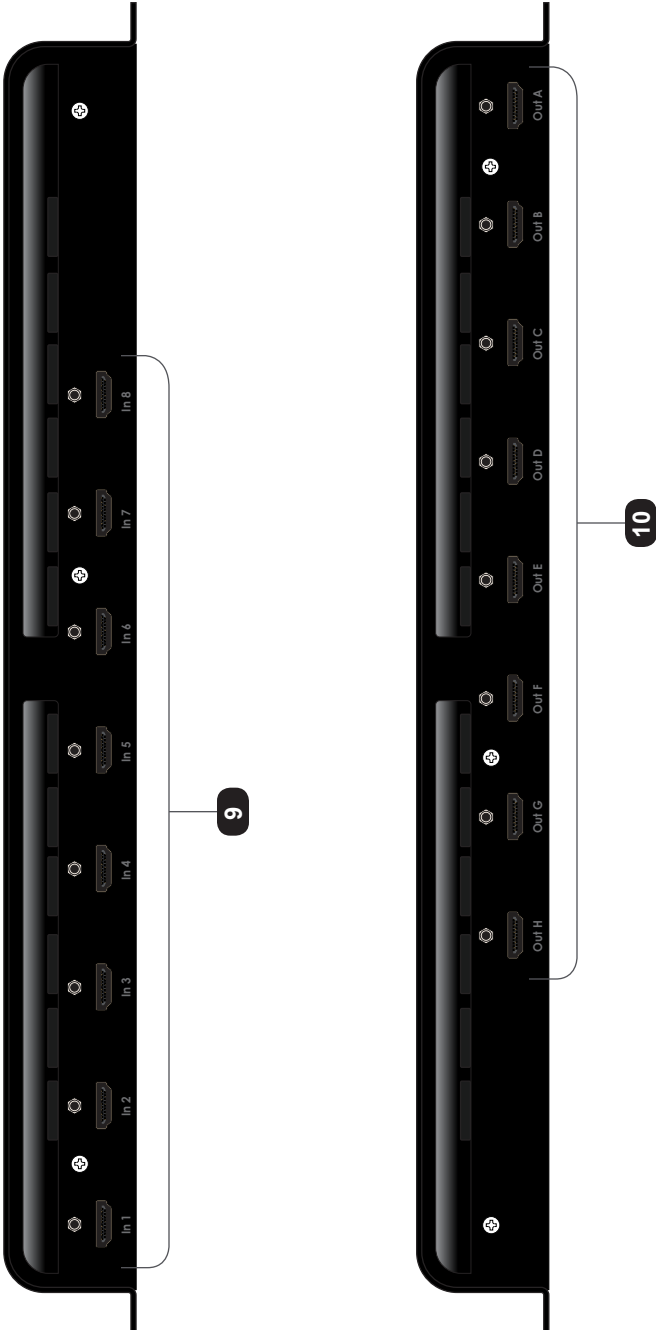

ID	Name	Description
1	Power	This LED indicator will glow solid blue when the matrix is powered.
2	Lock	This LED indicator will glow solid orange when the matrix is locked.
3	IR	Receives signals from the included IR remote control.
4	RS-232	Connect an RS-232 cable from this port to the automation device.
5	IR Ext	Connect an IR extender (Gefen part no. EXT-RMT-EXTIRN) to this port.
6	USB	This mini-USB port is used for upgrading the firmware.
7	IP Control	Connect a CAT-5e cable (or better) from this port to the network.
8	24V DC	Connect the included 24V DC power supply to this power receptacle.
9	In (1 - 8)	Connect up to eight 4K Ultra HD sources to the matrix using these HDMI ports.
10	Out (A - H)	Connect up to eight 4K Ultra HD displays to the matrix using these HDMI ports.

IR Remote Control

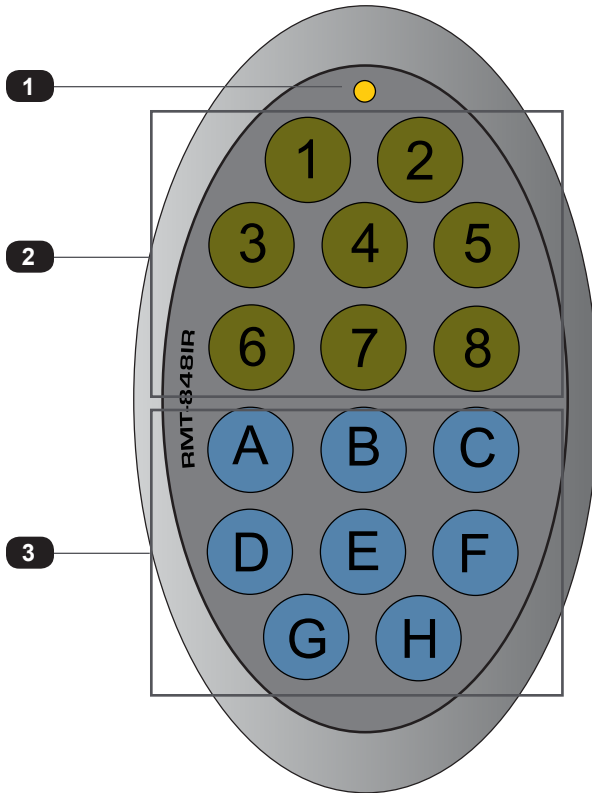

ID	Name	Description
1	Activity indicator	This LED will be activated momentarily each time an input or output button is pressed.
2	Input buttons	Press these buttons to select an input (1 - 8).
3	Output buttons	Press these buttons to select an output (A - H).

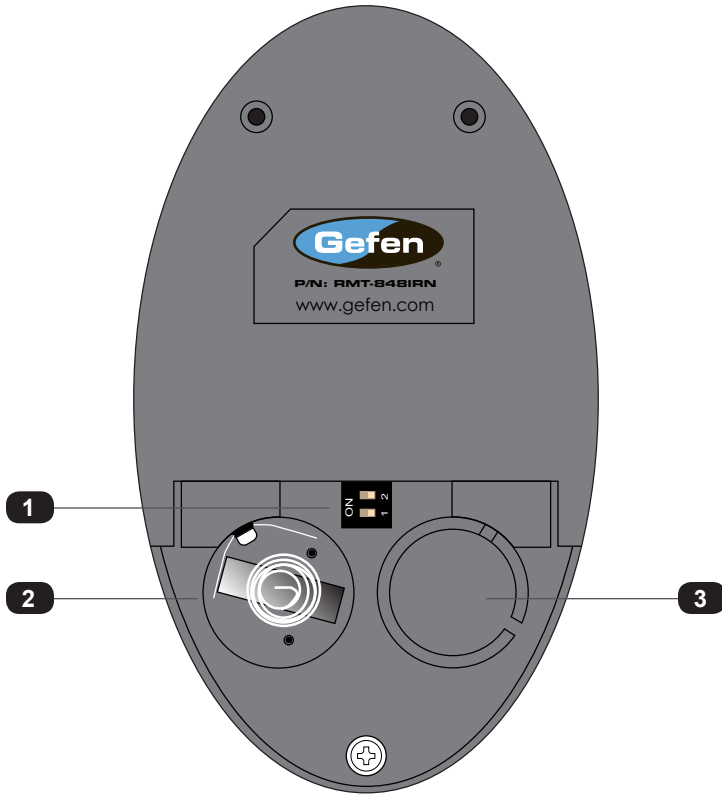

ID	Name	Description
1	DIP switch bank	Use these DIP switches to set the IR channel of the remote. See the next page for more information.
2	Primary battery slot (shown without battery)	Holds the battery for operating the remote. Use only 3V CR2032-type batteries. Make sure that the positive (+) side of the battery is facing up.
3	Alternate battery slot	Allows for the installation of secondary (backup) battery.

Installing the IR Remote Battery

The IR remote control unit ships with two batteries. Only one battery is required for operation. The second battery is a spare.



Warning

Use only 3V CR2032-type batteries. Risk of explosion if battery is replaced by an incorrect type. Dispose of used batteries according to the instructions.

1. Remove the back cover the IR Remote Control unit.
2. Insert the included battery into the primary battery slot. The positive (+) side of the battery should be facing up.
3. Replace the back cover.

Setting the IR Remote Channel

In order for the included IR remote control to communicate with the 4K Ultra HD 8x8 Matrix for HDMI, the IR remote control must be set to the same channel as the matrix. Use the `#set_ir` command to set the IR channel of the matrix.

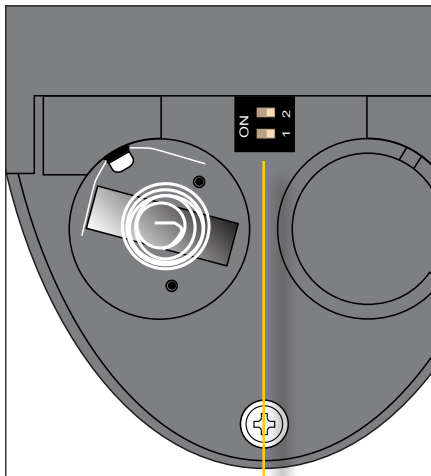

DIP switches

IR Channel	DIP settings
0 (default)	
1	
2	
3	

Connection Instructions

▶ Video

1. Use HDMI cables to connect up to eight 4K Ultra HD sources to the input ports (**In 1 - In 8**) on the matrix.
2. Connect up to eight 4K Ultra HD displays using the output ports (**Out A - Out H**) on the matrix.

▶ Ethernet

3. Connect a CAT-5e (or better) cable from the **IP Control** port on the matrix to a Local Area Network (LAN).

▶ RS-232

4. Connect an RS-232 cable from the **RS-232** port on the matrix to the RS-232 connector on the automation controller.

▶ IR

5. Connect an IR extender (Gefen part no. EXT-RMT-EXTIRN) to the **IR Ext** port on the matrix.

▶ Power

6. Connect the included power supply to the **24V DC** power receptacle on the matrix.
7. Connect the power cord to an available electrical outlet.

Sample Wiring Diagram

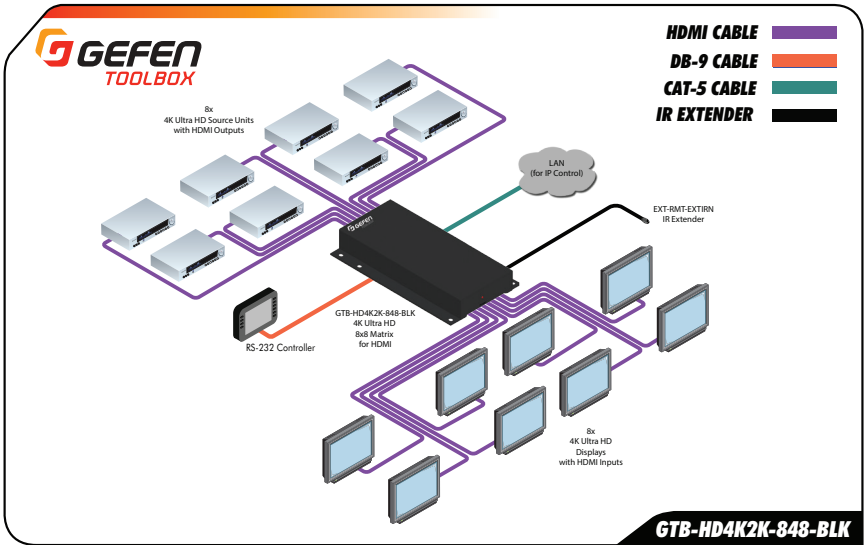

This page left intentionally blank.

4K Ultra HD 8x8 Matrix for HDMI

2 Basic Operation

Main Display

The *main display* of the 4K Ultra HD 8x8 Matrix for HDMI is a 16 character 2 line display. This display shows the current routing status of the matrix and is also used to display additional system information. When the unit is powered on, the following screen is displayed:



After a few moments, the status screen is displayed. The status screen is shown below:



Consecutively pressing the **Menu** button, on the front panel, will cycle through other screens such as FST mode and IP information:

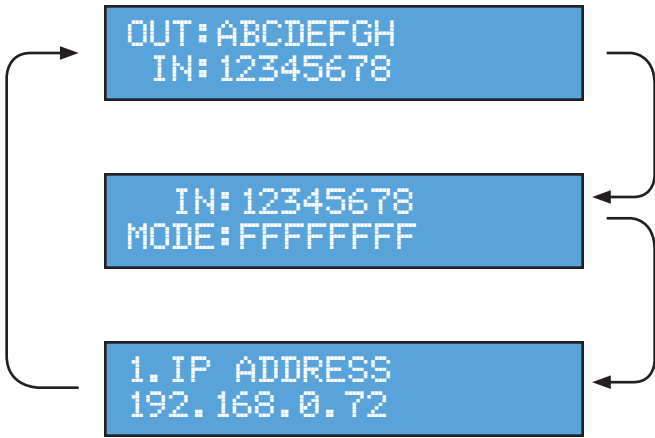

Determining the Current Routing State

In the example below, the first row (OUT) represents each HDMI output on the matrix. The bottom row (IN) represents each HDMI input on the matrix. Together, these two rows display the current routing state.

Starting on the bottom row, we can see that Input 3 has been routed to Outputs A, B, C, and D. Continuing, Input 4 is routed to Output E, Input 6 is routed to Output F, Input 8 is routed to Output G, and finally Input 1 is routed to Output H.



If all inputs are routed to their respective outputs, the front-panel display will appear as follows. This is referred to as a "1-to-1" routing state. This is the factory (default) setting for the 4K Ultra HD 8x8 Matrix for HDMI.



Selecting Sources and Outputs

1. Press the **Out -** or **Out +** button once. The routing state for Output A will be displayed.

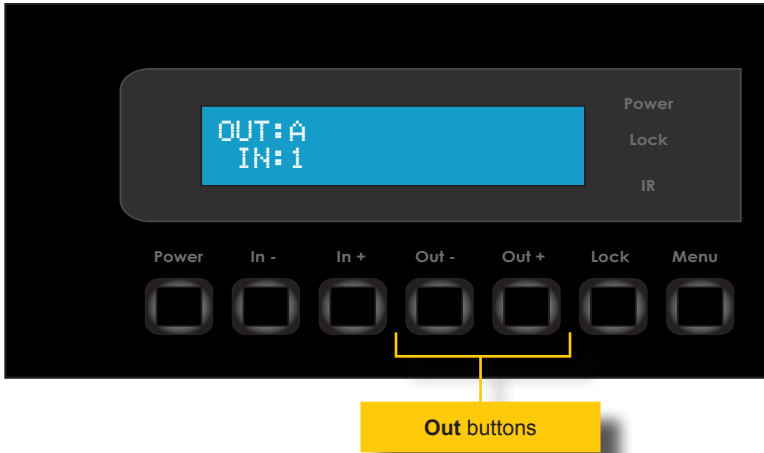

2. Press the **Out -** or **Out +** button again to cycle through the routing state for each output. Consecutively pressing the **Out +** button will cycle through each output, from left to right, starting with Output A.

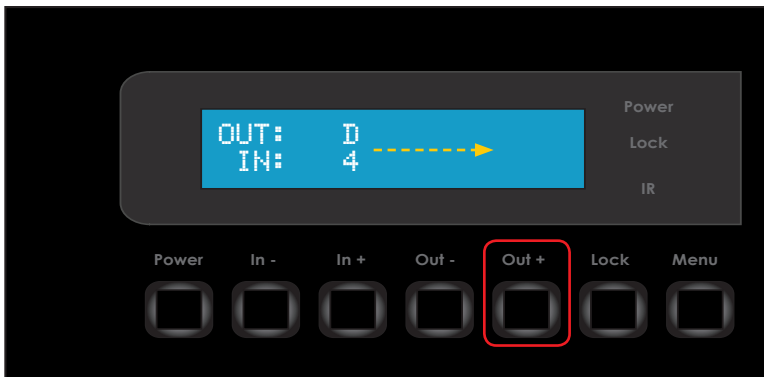

- Consecutively pressing the **Out -** button will cycle through each output, from right to left, starting with Output H.

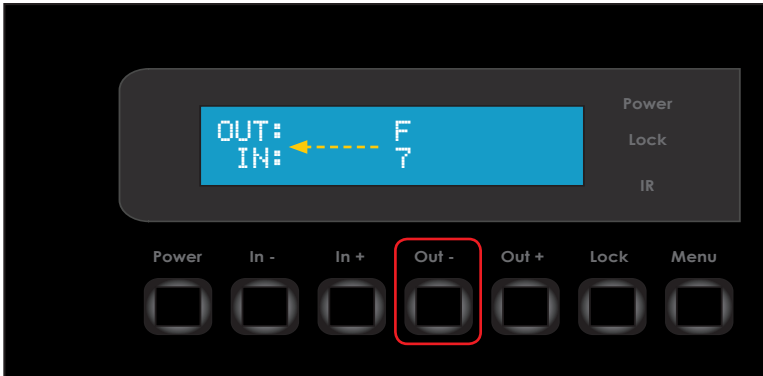

- Once the desired output has been selected, press the **In +** or **In -** button.

Consecutively pressing the **In -** button will decrement the input source value by a factor of 1 (within a range of 1 - 8). For example, if Input 7 was originally routed to Output G, then pressing the **In -** button will route Input 6 to Output G.

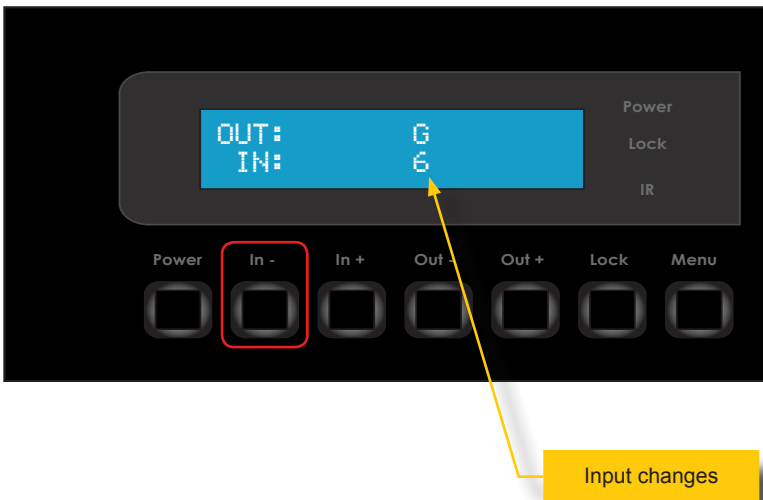

- Consecutively pressing the **In +** button will increment the input source value by a factor of 1 (within a range of 1 - 8). For example, if Input 6 was originally routed to Output G, then pressing the **In +** button will route Input 7 to Output G.

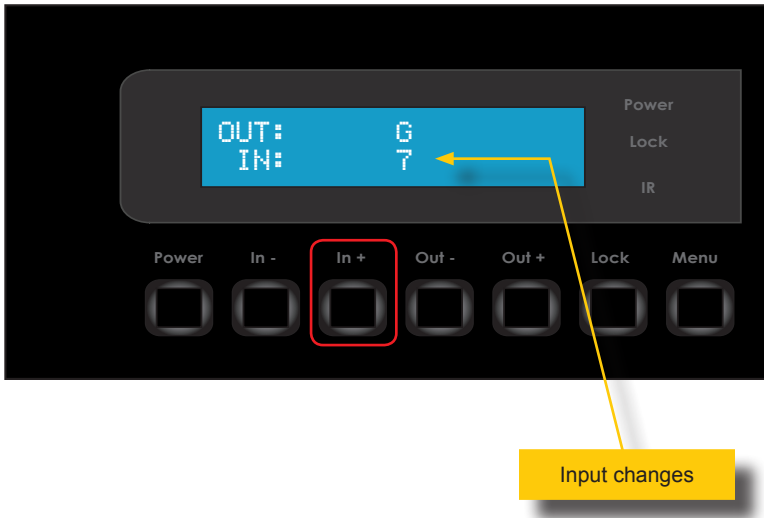

- To change the routing status of another output, press the **Out +** or **Out -** buttons to navigate to the desired output. Use the **In +** or **In -** buttons to change the source.
- Press the **Menu** button to accept the new routing state and return to the *status screen*.



Information

If the **Menu** button is not pressed after a routing change has been made, then routing change will not take effect. The matrix will automatically return to the *status screen* after about 20 seconds.

Locking the Matrix

To prevent an accidental routing change or power-down (by pressing the Power button), the front-panel buttons on the 4K Ultra HD 8x8 Matrix for HDMI can be locked. Locking the matrix also disables several RS-232 / Telnet commands.

1. Press the **Lock** button on the front-panel.
2. The Lock LED will glow bright orange to indicate that the front-panel buttons on the matrix have been locked.



If any buttons (other than the **Lock** button) are pressed while the 4K Ultra HD 8x8 Matrix for HDMI is locked, the following message will be displayed:

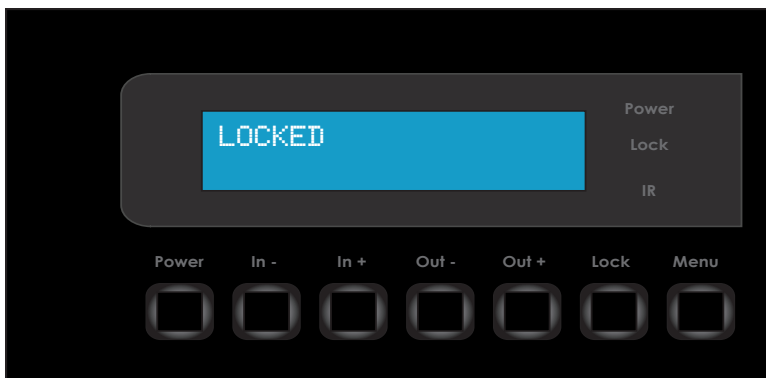

3. To unlock the matrix, press the **Lock** button again.

Fast Switching Technology



Fast Switching Technology (FST) is a Gefen software implementation for HDMI products. FST was created to improve the lengthy HDMI authentication process, based on the HDMI and HDCP specifications.

FST provides quicker audio/video source switching and greatly improves the overall audio/video system behavior and performance when more than one display is used in the system setup.

FST allows sources and displays, which are connected to the matrix, to be disconnected, re-connected, and / or powered ON or OFF without these events from interfering with the behavior of other sources and displays.

Fast Mode

Setting the 4K Ultra HD 8x8 Matrix for HDMI to Fast Mode will improve performance when connecting or disconnecting sources, and powering ON / OFF displays.



Information

When switching from Slow Mode to Fast Mode, the HDTV displays connected to the Matrix will blink momentarily.

Slow Mode

When set to Slow Mode, the 4K Ultra HD 8x8 Matrix for HDMI will follow the standard authentication process, based on the HDMI and HDCP specifications. Slow Mode is recommended when the source does not support multiple devices.

Fast / Slow Switching Modes

Each HDMI input can be set to *fast mode* or *slow mode*. It is recommended that each HDMI input be set to *fast mode* for best performance.

1. Consecutively press the **Menu** button on the front panel until the *switching mode* screen is displayed.

The first row (IN) represents each HDMI input on the matrix. The bottom row (MODE) represents the current switching mode of the HDMI input. By default, all inputs are set to *fast (F) mode*.



2. Press the **Out -** or **Out +** button to move into *selection mode*.
3. Press the **Out +** button to move to the right, through each input.

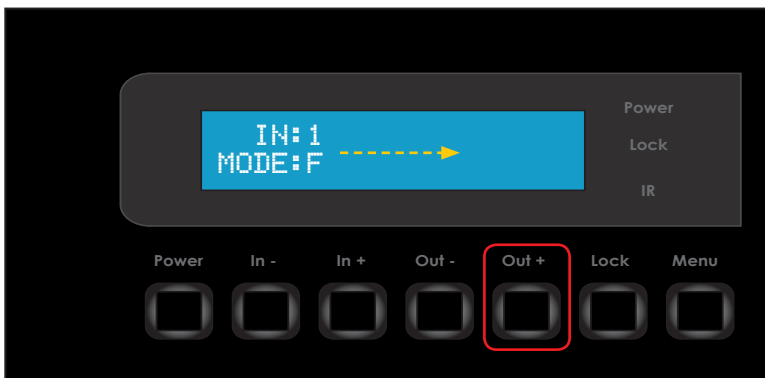

- Press the **Out -** button to move to the left, through each input.

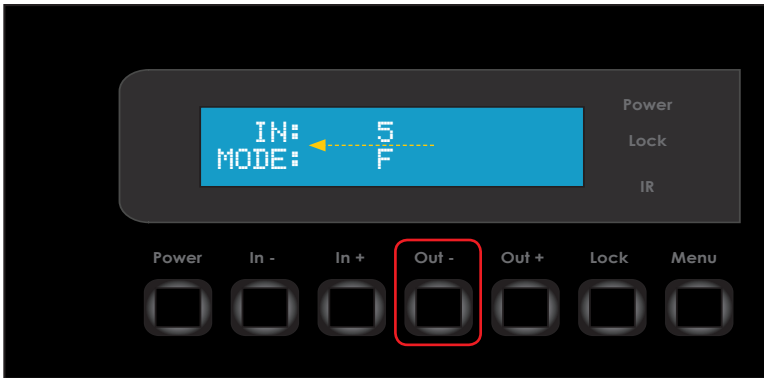

- Once the desired input has been selected, press the **In +** or **In -** button to toggle between *fast* or *slow* switching mode.

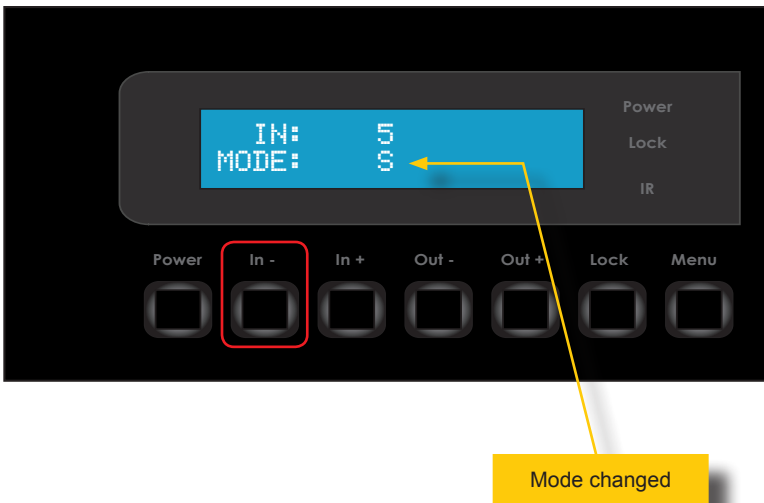

- To select a different input, press the **Out -** or **Out +** buttons.
- Press the **Menu** button to accept the routing changes and return to the *switching mode* screen.
- Press the **Menu** button a second time to return to the *status screen*.

Setting the IR Channel

In order for the 4K Ultra HD 8x8 Matrix for HDMI to communicate with the included IR Remote Control, both the matrix and the IR Remote Control must be set to the same IR channel. Refer to [Setting the IR Remote Channel \(page 7\)](#) for instructions on setting the IR channel for the included IR remote control unit. Follow the procedure outlined below to set the IR channel on the matrix.

1. From the *status screen*, simultaneously press the **In -** , **In +** , and **Out -** - buttons.
2. The current IR address will be displayed along with the DIP switch settings for the IR remote control.



3. Press the **In +** or **In -** - button to change the IR channel. The default IR channel is 0.

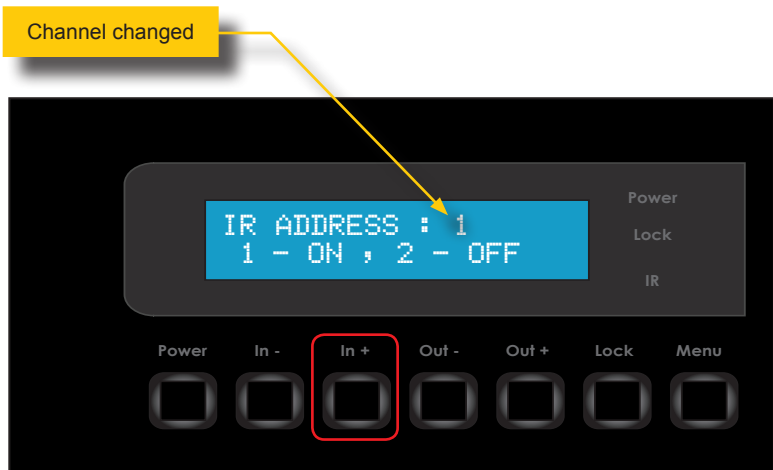

- After setting the IR address, make sure that the DIP switches on the IR Remote Control are set according to the information in the LCD display.

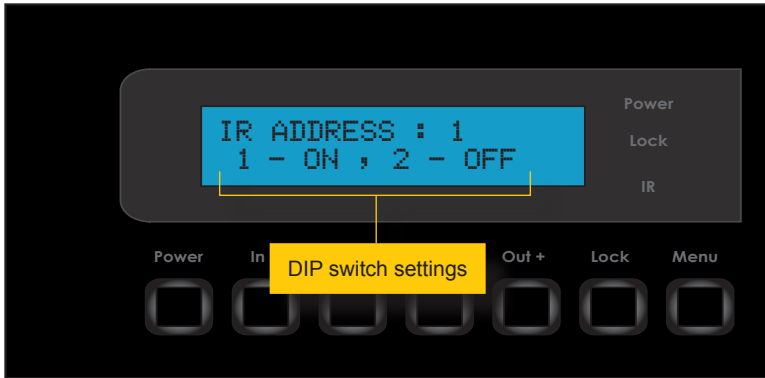

In this case, the 4K Ultra HD 8x8 Matrix for HDMI is set to IR channel 1. Therefore, the DIP switch 1 on the IR Remote Control must be set to the ON position and DIP switch 2 must be set to the OFF position.

- Press the **Menu** button to return to accept the changes and return to the *status screen*.



Using the IR Remote

Buttons 1- 8 on the IR remote control correspond to each HDMI input (Input 1 - 8) on the Matrix. Buttons A - H correspond to each HDMI output (Output A - H). To route a source to a display, press the desired output first, then press the input.

In the example below, we will route Input 4 to Output C.

1. Point the IR remote at the IR sensor, located on the top panel of the matrix.
2. Select Output C by pressing button C on the IR Remote Control. The letter C will appear in the upper right-hand corner of the LCD display.



3. Select Input 4 by pressing button 4 on the IR Remote Control. The number 4 will appear in the lower right-hand corner of the LCD display:



- After the input and output have been selected on the IR Remote Control, the numbers on the far right-hand of the LCD display will disappear and the new routing state will be displayed in the LCD display.



Input 4 is now routed to Output C.

Using the IR Extender

There may be situations where the IR sensor is blocked by a cabinet or other mounting device. In this case, an IR extender (Gefen part no. EXT-RMT-EXTIRN) can be connected to the **IR Ext** port on the matrix. The sensor on the IR extender behaves exactly like the sensor on the top panel of the matrix. Always point the IR remote control unit at the IR sensor.

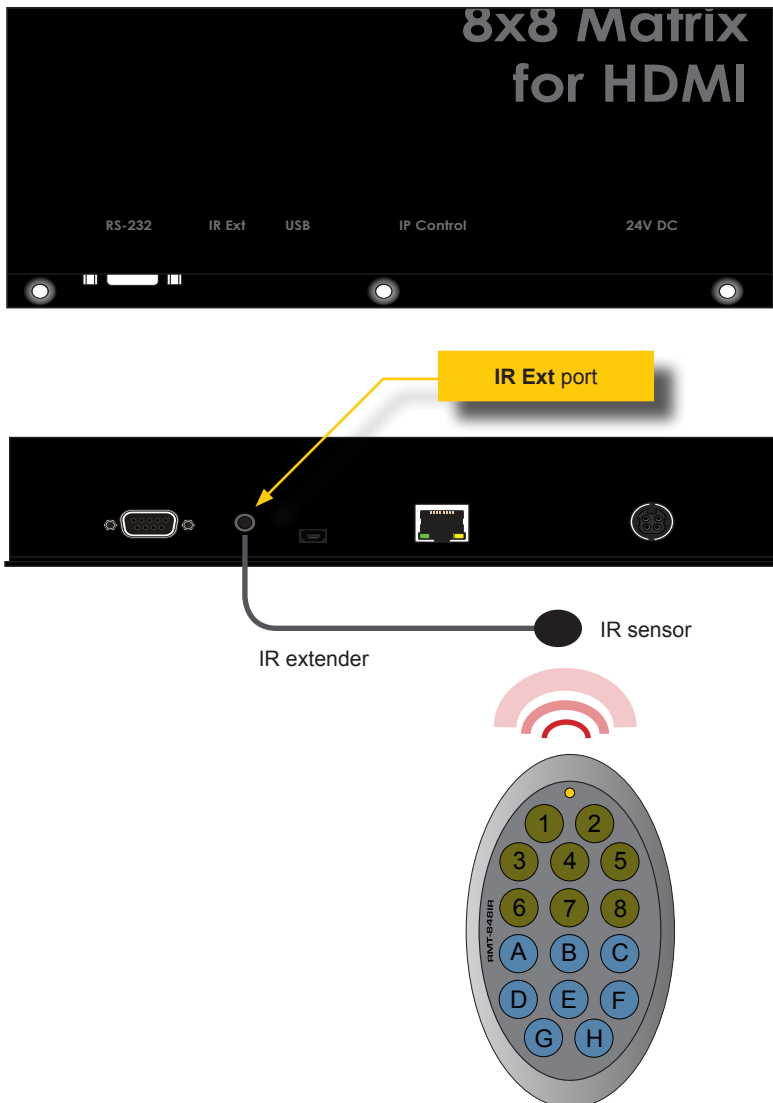

External EDID Management

The 4K Ultra HD 8x8 Matrix for HDMI features EDID Management. Before the source can send video or audio signals, the source device reads the EDID (Extended Display Identification Data) from the output devices connected to the matrix. The EDID contains information about what type of audio/video data that the source can send to each output device.

The 4K Ultra HD 8x8 Matrix for HDMI routes multiple sources to multiple output devices. This involves reading EDID data from more than one device. Management of the EDID data is important to maintain compatibility between all devices.

The following EDID features are copied from Output A:

- Supported Resolutions
- 3D Support
- Audio Features

Display Connections:

- If a device is not connected to Output A, then no EDID changes are made, meaning that the previous EDID information will be used. This state will be in effect until a display is connected to Output A and the Matrix is power-cycled.
- EDID is built from Output A to the Input. The audio block will be copied from Output A. EDID-copying is performed only when the Matrix is reset or power-cycled.

This page left intentionally blank.

This page left intentionally blank.

4K Ultra HD 8x8 Matrix for HDMI

3

Advanced Operation

Using Syner-G™

When using the IP to 2 x RS-232 Converter for the first time, it is recommended that the unit be configured using the Gefen Syner-G™ Software Suite. The Gefen Syner-G™ Software Suite is free software that is available from the Gefen Web site.

1. Download and install the Gefen Syner-G™ Software Suite. Download the application here: <http://www.gefen.com/synerg/>
2. Connect an Ethernet cable from the network to the **IP control** port on the product.
3. Launch the Gefen Syner-G™ Software Suite.
4. Click the GTB-HD4K2K0848 from the product list.

Select Function

Discover and Configure IP
Manage a Product
EDID Editor

My PC	10.5.64.90	00:1D:09:7E:E1:1F	Local Area Connecti
Product Name	IP Address	MAC Address	Description
EXT-CU-LAN	10.5.64.138	00:1C:91:04:60:75	EXT-CU-LAN RD MASTER
EXT-HDKVM-LAN-S	10.5.64.67	02:1D:00:5A:8D:53	EXT-DVIKVM-LAN-L-S
EXT-CU-LAN	10.5.64.146	00:1C:91:04:60:17	Dev CU-FAN Nick Desk
EXT-CU-LAN	10.5.64.130	00:1C:91:04:60:5D	EXT-CU-LAN RDSLAVE
GTB-HD4K2K-848	192.168.1.72	00:1C:91:04:80:14	4K2K 8x8 Matrix

Device Settings

Product Name GTB-HD4K2K-848	IP Mode Static
MAC Address 00:1C:91:04:80:14	Web GUI Port 80
IP Address 192.168.1.72	Telnet Port 23
Subnet Mask 255.255.255.0	Firmware Version v1.0J
Gateway IP 192.168.1.1	Hardware Version v2.0
DNS 	Description 4K2K 8x8 Matrix

- Under the Device Settings section, enter the desired IP address, subnet mask, gateway IP address, Web GUI port, and Telnet port in the supplied fields.

The screenshot shows the 'Device Settings' configuration page for a GTB-HD4K2K-848 device. The settings are as follows:

Field	Value
Product Name	GTB-HD4K2K-848
MAC Address	00:1C:91:04:80:14
IP Address	10.5.64.254
Subnet Mask	255.255.255.0
Gateway IP	10.5.64.1
DNS	
IP Mode	Static
Web GUI Port	80
Telnet Port	23
Firmware Version	v1.0J
Hardware Version	v2.0
Description	4K2K 8x8 Matrix

Buttons: [Web GUI](#), [Web Page](#), **Reboot**, **Show Me**, **Save**

If desired, the **Description** field can be changed as well. This is useful to identify if you have multiple units running on a network.

- Click the **Save** button at the bottom right-corner of the screen.
- Click the **Reboot** button.
- Click the **Web GUI** link, above the **Reboot** button, to access the built-in web interface.

The following table lists the default IP settings for the 4K Ultra HD 8x8 Matrix for HDMI.

Description	IP Address / Port	Description	IP Address / Port
IP Address	192.168.1.72	UDP Port	23
Subnet	255.255.255.0	Local UDP Port	50007
Gateway	192.168.1.254	Remote UDP IP	192.168.1.255
HTTP Port	80	Remote UDP Port	50008

RS-232 Interface

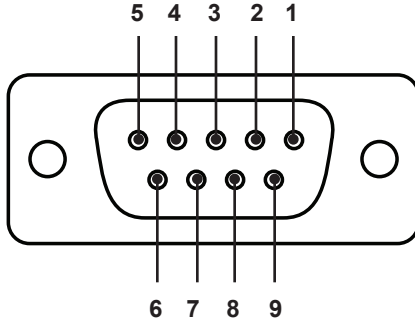

RS-232 Controller

Matrix

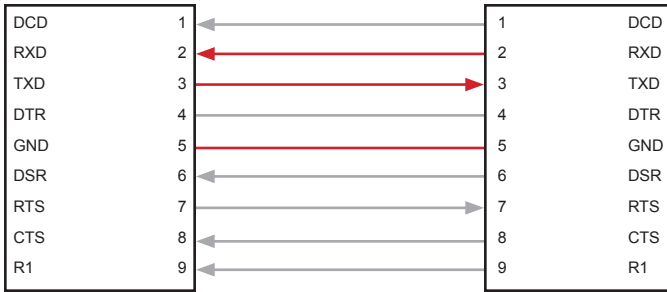

Only TXD, RXD, and GND pins are used.

RS-232 Settings

Description	Setting
Baud rate	19200
Data bits	8
Parity	None
Stop bits	1
Hardware flow control	None



Important

When sending Telnet or RS-232 commands, a carriage return (0d) and a line feed (0a) must be included at the end of the command.

Command	Description
#display_telnet_welcome	Enables or disables the Telnet welcome message
#echo	Enables or disables command feedback
#fadefault	Sets the unit to factory-default settings
#hdcp	Enables or disables HDCP on an input
#help	Displays the help list
#hpd_pulse	Sends an HPD pulse to the selected output
#ipconfig	Displays the IP configuration of the matrix
#lock_edid	Locks the EDID
#lock_matrix	Locks the matrix
#mask	Masks the specified output
#power	Toggles power on the matrix
#recall_preset	Recalls the specified routing preset
#resetip	Sets IP settings to factory-default
#save_preset	Saves the specified routing preset
#set_bank_name	Assigns a name to the specified EDID bank
#set_device_descr	Sets the device description
#set_edid	Sets the type of EDID to use
#set_http_port	Sets the HTTP listening port
#set_input_name	Sets the name of the specified input
#set_ir	Sets the IR channel of the matrix
#set_output_name	Sets the name of the specified output
#set_preset_name	Sets the name of the specified routing preset
#set_telnet_pass	Sets the Telnet password
#set_telnet_port	Sets the Telnet listening port
#set_udp_port	Sets the UDP listening port
#set_udp_remote_ip	Sets the UDP IP address
#set_udp_remote_port	Sets the remote UDP listening port
#set_webui_ad_pass	Sets the Web password for Administrator access
#set_webui_op_pass	Sets the Web password for Operator access
#sgateway	Sets the gateway address for the matrix
#show_bank_name	Displays the name of the specified EDID bank
#show_device_descr	Displays the name of the matrix
#show_discovery	Displays the status of the discovery feature
#show_fw	Displays the version of matrix firmware
#show_gateway	Displays the gateway address for the matrix

Command	Description
#show_hdcp	Displays the HDCP state of the specified input
#show_hpd	Displays the HPD state of the specified input
#show_http_port	Displays the HTTP listening port
#show_input_name	Displays the name of the specified input
#show_ip	Displays the IP address of the matrix
#show_ir	Displays the IR channel of the matrix
#show_mac_addr	Displays the MAC address of the matrix
#show_mask	Displays the mask status of the specified output
#show_me	Displays the status of the “show me” feature
#show_netmask	Displays the subnet mask of the matrix
#show_out_colordpt	Displays the color depth of the specified output
#show_out_res	Displays the resolution of the specified output
#show_output_name	Displays the name of the specified output
#show_preset_name	Displays the name of the specified routing preset
#show_r	Displays the routing state of the matrix
#show_rsense	Displays the Rsense status of the specified output
#show_telnet_port	Displays the Telnet listening port
#show_telnet_username	Displays the Telnet username
#show_udp_port	Displays the local UDP listening port
#show_udp_remote_ip	Displays the remote UDP IP address
#show_udp_remote_port	Displays the remote UDP listening port
#show_ver_data	Displays the firmware and hardware version data
#sipadd	Sets the IP address of the matrix
#snetmask	Sets the subnet mask for the matrix
#unmask	Disables masking on the specified output
#use_discovery	Enables or disables the discovery feature
#use_telnet_pass	Enables or disables the Telnet password
#use_udp_enable	Enables or disables the UDP protocol
m	Displays the routing status of the matrix
n	Displays the routing status of the specified output
r	Routes an input to the specified output(s)
s	Routes the specified input to all outputs

#display_telnet_welcome

Enables / disables the Telnet welcome message during a Telnet session.

Syntax

```
#display_telnet_welcome
```

Parameters

param1 Integer [0 ... 1]

Value	Description
0	Disable welcome message
1	Enable welcome message

Example

```
#display_telnet_welcome 1  
TELNET WELCOME SCREEN IS ENABLED
```

#echo

Enables / disables (toggles) the RS-232 feedback.

Syntax

```
#echo param1
```

Parameters

param1 Integer [0 ... 1]

Value	Description
0	Disable feedback
1	Enable feedback

Example

```
#echo 1  
LOCAL ECHO IS ON
```

#fadefault

Resets the matrix to factory-default settings. Outputs are unmasked and all IP and UDP settings are reset to default settings.

Syntax

```
#fadefault
```

Parameters

None

Example

```
#fadefault
```

Related Commands

```
#resetip
```

#hdcv

Enables / disables HDCP detection on the selected input.

Syntax

```
#hdcv param1
```

Parameters

param1 Integer [0 ... 1]

Value	Description
0	Disable HDCP
1	Enable HDCP

Example

```
#hdcv 4 0  
INPUT 4 HDCP IS DISABLE
```

Related Commands

```
#show_hdcv
```

#help

Displays the list of available RS-232 / Telnet commands. Help on a specific command can be displayed when using *param1*.

Syntax

```
#hdcv param1
```

Parameters

<i>param1</i>	Integer	[0 ... 1]
---------------	---------	-----------

Example

```
#help #sipadd  
  
#SIPADD PARAM 1  
SET THE IP ADDRESS  
PARAM 1 = XXX.XXX.XXX.XXX  
WHERE XXX: 0 - 255
```

#hpd_pulse

Cycles the HPD line on the specified input. Issuing this command is identical to physically disconnecting and reconnecting the cable between the source and the matrix. If *param1* = 0, then all inputs will receive the HPD pulse

Syntax

```
#hpd_pulse param1
```

Parameters

<i>param1</i>	Integer	[1 ... 8]
---------------	---------	-----------

Example

```
#hpd_pulse 2  
HPD PULSE HAS BEEN SENT TO INPUT 2
```

Related Commands

```
#show_hpd
```

#ipconfig

The #ipconfig command displays the current TCP settings.

Syntax

```
#ipconfig
```

Parameters

None

Example

```
#ipconfig
IP Configuration is :

IP: 10.5.64.247
NETMASK: 255.255.0.0
GATEWAY: 10.5.64.1
```

Related Commands

```
#resetip
#sgateway
#show_netmask
#sipadd
#snetmask
```

#lock_edid

Secures the Local EDID by disabling the automatic loading of the downstream EDID when the matrix is powered.

Syntax

```
#lock_edid param1
```

Parameters

param1 Integer [0 ... 1]

Value	Description
0	Disable
1	Enable

Example

```
#lock_edid 1  
MATRIX EDID IS LOCKED
```

Related Commands

```
#set_edid
```

#lock_matrix

Locks or unlocks the matrix. When the matrix is locked, all functions are disabled including the front panel, RS-232, and Telnet.

Syntax

```
#lock_matrix param1
```

Parameters

param1 Integer [0 ... 1]

Value	Description
0	Unlock
1	Lock

Example

```
#lock_matrix 1  
MATRIX IS LOCKED
```

#mask

Masks the video on the specified output(s). If *param1* = 0, then all outputs are masked. Use the `#unmask` command to disable output masking.

Syntax

```
#mask param1
```

Parameters

<i>param1</i>	Integer / Character	[0, A ... H]
---------------	---------------------	--------------

Examples

```
#mask A F G  
OUTPUTS A, F, G ARE MASKED
```

```
#mask 0  
ALL OUTPUTS ARE MASKED
```

Related Commands

```
#unmask  
#show_mask
```

#power

Powers ON or OFF the matrix.

Syntax

```
#power param1
```

Parameters

param1 Integer [0 ... 1]

Value	Description
0	Power OFF
1	Power ON

Example

```
#power 1
```

Related Commands

```
#reboot
```

#reboot

Reboots the matrix. Executing this command is the equivalent of cycling power on the matrix. The matrix must be rebooted after changing any of the IP settings

Syntax

```
#reboot
```

Parameters

None

Example

```
#reboot  
MATRIX WILL REBOOT SHORTLY *REBOOT UNIT IN 2 SECONDS
```

Related Commands

```
#power
```

#recall_preset

Loads the specified routing preset.

Syntax

```
#recall_preset
```

Parameters

None

Example

```
#recall_preset 2  
RECALLED THE ROUTING STATE OF PRESET 2
```

Related Commands

```
#save_preset  
#set_preset_name  
#show_preset_name
```

#resetip

Resets the IP configuration to factory-default settings. The matrix must be rebooted after executing this command.

Syntax

```
#resetip
```

Parameters

None

Example

```
#resetip
```

Related Commands

```
#fadefault
```

#save_preset

Saves the current routing state to the specified preset.

Syntax

```
#save_preset param1
```

Parameters

<i>param1</i>	Integer	[1 ... 8]
---------------	---------	-----------

Example

```
#save_preset 2  
CURRENT ROUTING STATE IS SAVED TO PRESET 2
```

Related Commands

```
#recall_preset  
#set_preset_name  
#show_preset_name
```

#set_bank_name

Assigns a name to the specified bank.

Syntax

```
#set_bank_name param1 param2
```

Parameters

<i>param1</i>	Integer	[1 ... 8]
<i>param2</i>	String	

Example

```
#set_bank_name 5 SonyXBR  
SonyXBR NAME IS ASSIGNED TO BANK 5
```

Related Commands

```
#show_bank_name
```

#set_edid

Sets the specified EDID type to an input or bank. If *param1* = *default* or *param1* = *dynamic*, then set *param2* = 0.

Syntax

```
#set_edid param1 param2 param3 param4
```

Parameters

param1

String

param1	Description
default	Use default EDID
dynamic	Use dynamic EDID
bank	Use EDID bank
output	Use EDID on Output

param2

Integer

[0, 1 ... 8]

param1	Description
0	Default / Dynamic
1 ... 8	Bank / Output

param3

String

param1	Description
input	Specifies an input
bank	Specifies an EDID bank

param4

Integer

[1 ... 8]

param1	Description
1 ... 8	Input or Bank

(continued on next page)

When *param1* = *dynamic*, the specified input will be set to Dynamic EDID. This can be observed by accessing the Manage EDID tab, in the Web interface. When an input is set to Dynamic EDID, the input will use the EDID of the last selected output during the routing process. The order in which outputs are routed is important when using Dynamic EDID.

Examples

```
#set_edid dynamic 0 input 4  
COPY DYNAMIC EDID TO INPUT4.
```

In this example, Input 4 is set to Dynamic EDID.

If the following routing command is issued, then the EDID from Output 3 (not Output 2) will be used by Input 1:

```
r 4 2 3  
INPUT 4 IS SET TO OUTPUTS 2, 3
```

However, if we wanted to use the EDID from Output 2, we would write the command as:

```
r 4 3 2  
INPUT 4 IS SET TO OUTPUTS 3, 2
```

Since Output 2 was the last output that was specified, this will be the EDID that Input 4 will use.

Related Commands

```
#lock_edid
```

#set_http_port

Specifies the Web server listening port. The matrix must be rebooted after executing this command. The default port setting is 80. Use the #show_http_port command to display the current HTTP listening port.

Syntax

```
#set_http_port param1
```

Parameters

<i>param1</i>	Integer	[1 ... 1024]
---------------	---------	--------------

Example

```
#set_http_port 81  
HTTP PORT IS: 81
```

Related Commands

```
#show_http_port
```

#set_input_name

Assigns a name to the specified input.

Syntax

```
#set_input_name param1 param2
```

Parameters

<i>param1</i>	Integer	[1 ... 8]
<i>param2</i>	String	

Example

```
#set_input_name 3 Blu-ray  
Blu-ray NAME IS ASSIGNED TO INPUT 3
```

Related Commands

```
#set_output_name  
#show_input_name  
#show_output_name
```

#set_ir

Sets the IR channel for the matrix. The default IR channel setting is 0. The IR channel for the switch can also be set under the **Configuration** tab within the Web interface. See [Configuration > System Configuration](#) for more information.

Syntax

```
#set_ir param1
```

Parameters

param1

Integer

[0 ... 3]

param1	Description
0	IR channel 0
1	IR channel 1
2	IR channel 2
3	IR channel 3

Example

```
#set_ir 2
IR CHANNEL IS SET TO CHANNEL 2
```

Related Commands

```
#show_ir
```

#set_output_name

Assigns a name to the output on the matrix. The name of the output is limited to 15 characters. Names longer than 15 characters will be truncated. To name an output, use the `#set_output_name` command.

Syntax

```
#set_output_name param1 param2
```

Parameters

<i>param1</i>	Character	[A ... H]
<i>param2</i>	String	

Example

```
#set_output_name D Samsung  
Samsung NAME IS ASSIGNED TO OUTPUT D
```

Related Commands

```
#set_input_name  
#show_input_name  
#show_output_name
```

#set_preset_name

Assigns a name to the specified preset. The name of the preset is limited to 8 characters. To display the name of a preset, use the `#show_preset_name` command.

Syntax

```
#set_preset_name param1 param2
```

Parameters

<i>param1</i>	Integer	[1 ... 8]
<i>param2</i>	String	

Example

```
#set_preset_name 4 MBedRoom  
MBedRoom NAME IS ASSIGNED TO PRESET 4
```

Related Commands

```
#show_preset_name
```

#set_telnet_pass

The #set_telnet_pass command sets the Telnet password. The password is case-sensitive and cannot exceed 8 characters in length. The default password is Admin.

Syntax

```
#set_telnet_pass param1
```

Parameters

param1 String

Example

```
#set_telnet_pass 3v3r3st  
TELNET Interface Password Is Set.
```

#set_telnet_port

The `#set_telnet_port` command sets the Telnet listening port. The matrix must be rebooted after executing this command. The default port setting is 23. Use the `#show_telnet_port` command to display the current Telnet listening port.

Syntax

```
#set_telnet_port param1
```

Parameters

<i>param1</i>	Integer	[1 ... 1024]
---------------	---------	--------------

Example

```
#set_telnet_port 21
```

Related Commands

```
#show_telnet_port
```

#set_udp_port

The `#set_telnet_port` command sets the Telnet listening port. The matrix must be rebooted after executing this command. The default port setting is 23. Use the `#show_telnet_port` command to display the current Telnet listening port.

Syntax

```
#set_udp_port param1
```

Parameters

<i>param1</i>	Integer	[1 ... 1024]
---------------	---------	--------------

Example

```
#set_udp_port 50007
UDP COMMUNICATION PORT 50007 IS SET
```

Related Commands

```
#set_udp_remote_port
#show_udp_port
#show_udp_remote_port
```

#set_udp_remote_ip

Sets the remote UDP IP address. The IP address must be specified using dot-decimal notation. The default UDP remote IP address is 192.168.1.255. The matrix must be rebooted after executing this command.

Syntax

```
#set_udp_port param1
```

Parameters

<i>param1</i>	String
---------------	--------

Example

```
#set_udp_remote_ip 192.168.1.80  
REMOTE UDP IP ADDRESS IS SET
```

Related Commands

```
#show_udp_remote_ip
```

#set_udp_remote_port

Sets the remote UDP listening port. The default remote UDP listening port is 50008. The matrix must be rebooted after executing this command.

Syntax

```
#set_udp_remote_port param1
```

Parameters

<i>param1</i>	Integer	[0 ... 65535]
---------------	---------	---------------

Example

```
#set_udp_remote_port 50007  
UDP COMMUNICATION PORT 50007 IS SET
```

Related Commands

```
#set_udp_port  
#show_udp_port  
#show_udp_remote_port
```

#set_webui_ad_pass

The `#set_webui_ad_pass` command sets the Administrator password for the Web GUI. The password is case-sensitive and cannot exceed 7 characters in length. The default password is `Admin`.

Syntax

```
#set_webui_ad_pass param1
```

Parameters

<i>param1</i>	String
---------------	--------

Example

```
#set_webui_ad_pass bo55man  
Web UI Administrator Password Is Set.
```

Related Commands

```
#set_webui_op_pass
```

#set_webui_op_pass

The `#set_webui_ad_pass` command sets the Operator password for the Web GUI. The default password is Admin.

Syntax

```
#set_webui_op_pass param1
```

Parameters

param1 String

Example

```
#set_webui_op_pass mlni0n  
Web UI Operator Password Is Set.
```

Related Commands

```
#set_webui_ad_pass
```

#sgateway

Sets the gateway address. The gateway must be typed using dot-decimal notation. The matrix must be rebooted after executing this command. The default gateway is 192.168.1.1.

Syntax

```
#sgateway param1
```

Parameters

<i>param1</i>	String
---------------	--------

Example

```
#sgateway 10.5.64.1  
GateWay Address 10.5.64.1 Is Set. Please Reboot The Unit.
```

Related Commands

```
#ipconfig  
#show_gateway  
#sipadd  
#snetmask
```

#show_bank_name

Displays the name for the specified EDID bank.

Syntax

```
#show_bank_name param1
```

Parameters

<i>param1</i>	Integer	[1 ... 8]
---------------	---------	-----------

Example

```
#show_bank_name 5  
THE NAME FOR BANK 5 IS: SonyXBR
```

Related Commands

```
#set_bank_name
```

#show_device_descr

Displays the device description. Use the `#set_device_descr` command to set the device description.

Syntax

```
#show_device_descr
```

Parameters

None

Example

```
#show_device_descr  
DEVICE DESCRIPTION NAME IS SET TO 8x8Matrix
```

Related Commands

```
#set_device_descr
```

#show_discovery

Displays the current state of the discovery feature.

Syntax

```
#show_discovery
```

Parameters

None

Example

```
#show_discovery  
DISCOVERY PROTOCOL IS ENABLED
```

Related Commands

```
#show_me  
#use_discovery
```

#show_fw

Displays the current version of firmware.

Syntax

```
#show_fw
```

Parameters

None

Example

```
#show_fw  
FIRMWARE VERSION = GTB-HD4K2K-848 v1.0H
```

#show_gateway

Displays the gateway address of the matrix.

Syntax

```
#show_gateway
```

Parameters

None

Example

```
#show_gateway  
GATEWAY ADDRESS IS: 10.5.64.1
```

Related Commands

```
#ipconfig  
#sgateway  
#sipadd  
#snetmask
```

#show_hdcp

Displays the HDCP status of the specified input. Use the #hdcp command to enable or disable HDCP.

Syntax

```
#show_hdcp
```

Parameters

None

Example

```
#show_hdcp 3  
INPUT 3 HDCP IS ENABLED
```

Related Commands

```
#hdcp
```

#show_hpd

Displays the HPD status of the specified output. The name of the output is included in the feedback.

Syntax

```
#show_hpd param1
```

Parameters

<i>param1</i>	Character	[A ... H]
---------------	-----------	-----------

Example

```
#show_hpd D  
HPD OF OUTPUT D(OUTPUT4) IS HIGH
```

Related Commands

```
#show_hpd
```

#show_http_port

Displays the current HTTP listening port of the matrix. Use the `#set_http_port` command to set the HTTP listening port.

Syntax

```
#show_http_port
```

Parameters

None

Example

```
#show_http_port  
HTTP COMMUNICATION PORT IS: 80
```

Related Commands

```
#set_http_port
```

#show_input_name

Displays the name of the specified input. To name an input, use the `#set_input_name` command.

Syntax

```
#show_input param1
```

Parameters

None

Example

```
#show_input_name 3  
THE NAME FOR INPUT 3 IS: Blu-ray
```

Related Commands

```
#set_input_name  
#set_output_name  
#show_output_name
```

#show_ip

Displays the current gateway address of the matrix. Use the #sipadd command to set the IP address of the matrix.

Syntax

```
#show_ip
```

Parameters

None

Example

```
#show_ip  
IP ADDRESS IS: 10.5.64.247
```

Related Commands

```
#ipconfig  
#show_gateway  
#show_netmask  
#sipadd
```

#show_ir

Displays the current IR channel of the matrix. The IR channel of the matrix must match the IR channel of the IR remote control. See [Setting the IR Remote Channel \(page 7\)](#) for more information.

Syntax

```
#show_ir
```

Parameters

None

Example

```
#show_ir  
CURRENT IR CHANNEL IS: 0
```

Related Commands

```
#set_ir
```

#show_mac_addr

The #show_mac_addr command displays the MAC address of the matrix.

Syntax

```
#show_mac_addr
```

Parameters

None

Example

```
#show_mac_addr  
MAC ADDRESS IS: 00-1a-07-11-01-76
```

#show_mask

Displays the mask status of the specified output.

Syntax

```
#show_mask param1
```

Parameters

<i>param1</i>	Character	[A ... H]
---------------	-----------	-----------

Example

```
#show_mask b  
OUTPUT B(OUTPUT2) IS UNMASKED
```

Related Commands

[#mask](#)

#show_me

Enables or disables the *show me* feature on the matrix.

Syntax

```
#show_me
```

Parameters

param1 Integer [1 ... 2]

param1	Description
0	Disabled
1	Enabled

Example

```
#show_me 1  
SHOW ME IS ON
```

Related Commands

```
#show_discovery  
#use_discovery
```

#show_netmask

Displays the current subnet mask address of the matrix. Use the #snetmask command to set the subnet mask address.

Syntax

```
#show_netmask
```

Parameters

None

Example

```
#show_netmask  
NETMASK ADDRESS IS: 255.255.255.0
```

Related Commands

```
#snetmask
```

#show_out_colordpt

Displays the highest color depth supported by the specified display based on the EDID of the connected sink (display) device. If no display is attached to the specified output, then the command will return: NO SIGNAL

Syntax

```
#show_out_colordpt param1
```

Parameters

<i>param1</i>	Character	[A ... H]
---------------	-----------	-----------

Example

```
#show_out_colordpt F  
8 BITS DVI
```

Related Commands

```
#show_out_res
```

#show_out_res

The #show_out_res command displays the highest resolution supported by the specified display based on the EDID of the connected sink (display) device. If no display is attached to the specified output, then the command will return: NO SIGNAL

Syntax

```
#show_out_res param1
```

Parameters

<i>param1</i>	Integer	[1 ... 8]
---------------	---------	-----------

Example

```
#show_out_res 1  
OUTPUT 1 RESOLUTION IS 1600x900P
```

Related Commands

```
#show_out_colordpt
```

#show_output_name

Displays the name of the output. To name an output, use the `#set_output_name` command.

Syntax

```
#show_output_name param1
```

Parameters

<i>param1</i>	Character	[A ... H]
---------------	-----------	-----------

Example

```
#show_output_name D  
THE NAME FOR OUTPUT D IS: Samsung
```

Related Commands

```
#set_input_name  
#set_output_name  
#show_input_name
```

#show_preset_name

Displays the name for the specified preset. To assign a name to a preset, use the `#set_preset_name` command.

Syntax

```
#show_preset_name param1
```

Parameters

<i>param1</i>	Integer	[1 ... 8]
---------------	---------	-----------

Example

```
#show_preset_name 4  
THE NAME FOR PRESET 4 IS: MBedRoom
```

Related Commands

```
#recall_preset  
#save_preset  
#set_preset_name
```

#show_r

Displays the routing status of the specified output.

Syntax

```
#show_r param1
```

Parameters

<i>param1</i>	Character	[A ... H]
---------------	-----------	-----------

Example

```
#show_r B  
OUTPUT B (OUTPUT2) IS ROUTED TO INPUT 3 (INPUT3)
```

Related Commands

r

#show_rsense

Displays the Rsense status of the specified output.

Syntax

```
#show_rsense param1
```

Parameters

<i>param1</i>	Character	[A ... H]
---------------	-----------	-----------

Example

```
#show_rsense A  
RSENSE OF OUTPUT A(OUTPUT1) IS LOW
```

Related Commands

```
#show_hpd
```

#show_telnet_port

Displays the current Telnet port of the matrix. Use the `#set_telnet_port` command to set the Telnet listening port.

Syntax

```
#show_telnet_port
```

Parameters

None

Example

```
#show_telnet_port  
TELNET COMMUNICATION PORT IS: 23
```

Related Commands

```
#set_telnet_port
```

#show_telnet_username

Displays the user name for the current Telnet session.

Syntax

```
#show_telnet_username
```

Parameters

None

Example

```
#show_telnet_username  
User Name For TELNET Is : Admin
```

Related Commands

```
#set_telnet_pass
```

#show_udp_port

Displays the current local UDP listening port. Use the `#set_udp_port` command to set the local UDP listening port.

Syntax

```
#show_udp_port
```

Parameters

None

Example

```
#show_udp_port
UDP COMMUNICATION PORT IS: 50007
```

Related Commands

```
#set_udp_port
```

#show_udp_remote_ip

Displays the remote UDP IP address. Use the `#set_udp_remote_ip` command to set the remote UDP IP address.

Syntax

```
#show_udp_remote_ip
```

Parameters

None

Example

```
#show_udp_remote_ip  
REMOTE UDP IP ADDRESS IS: 192.168.1.80
```

Related Commands

```
#set_udp_remote_ip
```

#show_udp_remote_port

Displays the remote UDP port. Use the `#set_udp_remote_port` command to set the remote UDP remote port.

Syntax

```
#show_udp_remote_port
```

Parameters

None

Example

```
#show_udp_remote_ip  
REMOTE UDP COMMUNICATION PORT IS: 50008
```

Related Commands

```
#set_udp_remote_port
```

#show_ver_data

Displays the current software and hardware version.

Syntax

```
#show_ver_data
```

Parameters

None

Example

```
#show_ver_data  
SOFTWARE AND HARDWARE VERSION: v3.2B PCB-1707*B
```

#sipadd

Sets the IP address of the matrix. The IP address must be entered using dot-decimal notation. The matrix must be rebooted after executing this command. The default IP address is 192.168.1.72. Use the `#show_ip` or `#ipconfig` command to display the current IP address of the matrix.

Syntax

```
#sipadd param1
```

Parameters

<i>param1</i>	String
---------------	--------

Example

```
#sipadd 10.5.64.247  
IP Address 10.5.64.247 Is Set. Please Reboot The Unit.
```

Related Commands

```
#ipconfig  
#show_ip  
#sgateway  
#snetmask
```

#snetmask

The #snetmask command sets the subnet mask. The net mask must be entered using dot-decimal notation. The matrix must be rebooted after executing this command. The default net mask is 255.255.255.0. Use the #ipconfig or #show_netmask command to display the current net mask of the matrix.

Syntax

```
#snetmask param1
```

Parameters

<i>param1</i>	String
---------------	--------

Example

```
#snetmask 255.255.0.0  
NetMask Address 255.255.0.0 Is Set. Please Reboot The Unit.
```

Related Commands

```
#ipconfig  
#show_ip  
#sgateway  
#sipadd
```

#unmask

The `#unmask` command unmask the specified output(s). Use the `#mask` command to mask the specified output(s). Multiple outputs may be specified. If `param1 = 0`, then all outputs are unmasked.

Syntax

```
#unmask param1 [...param8]
```

Parameters

<i>param1</i>	Integer / Character	[0, A ... H]
---------------	---------------------	--------------

Examples

```
#unmask e  
OUTPUT E IS UNMASKED
```

```
#unmask c d g  
OUTPUTS C, D, G ARE UNMASKED
```

```
#unmask 0  
ALL OUTPUTS ARE UNMASKED
```

Related Commands

```
#mask  
#show_mask
```

#use_discovery

Enables or disables the *discovery* feature. By default, the discovery feature is *enabled*.

Syntax

```
#use_discovery param1
```

Parameters

param1 Integer [0 ... 1]

param1	Description
0	Disabled
1	Enabled

Example

```
#use_discovery 1  
DISCOVERY PROTOCOL IS ENABLED
```

Related Commands

```
#show_discovery  
#show_me
```

#use_telnet_pass

Enables or disables the password credentials for each Telnet session. The default setting is 0 (disabled). Use the `#set_telnet_pass` command to set the Telnet password.

Syntax

```
#use_telnet_pass param1
```

Parameters

param1 Integer [0 ... 1]

param1	Description
0	Disabled
1	Enabled

Example

```
#use_telnet_pass 0  
Telnet Interface Password Is Disable
```

Related Commands

```
#set_telnet_pass  
#show_telnet_username
```

#use_udp_enable

Enables or disables UDP access mode.

Syntax

```
#use_udp_enable param1
```

Parameters

param1 Integer [0 ... 1]

param1	Description
0	Disabled
1	Enabled

Example

```
#use_udp_enable 0  
UDP ACCESS IS DISABLE
```

m

Displays the current routing status of the matrix. Masking and locking status of the matrix is also provided. Do not precede the `m` command with the “#” symbol.

Syntax

```
m
```

Parameters

None

Example

```
m
```

```
Out: A B C D E F G H  
In:  1 2 3 4 5 6 7 8
```

```
ALL OUTPUTS ARE UNMASKED  
MATRIX IS UNLOCKED
```

Related Commands

```
#show_r  
n  
r  
s
```

n

Displays the routing status of the specified output. Do not precede the `n` command with the '#' symbol. If `param1 = 0`, then the routing state for all outputs is returned.

Syntax

```
n param1
```

Parameters

<i>param1</i>	Integer / Output	[0, A ... H]
---------------	------------------	--------------

Examples

```
n c  
C3
```

```
n 0  
A1B2C3D4E5F6G7H8
```

Related Commands

```
#show_r  
m  
r  
s
```

r

Routes the specified input to the output. Do not precede this command with the “#” symbol. Also see the `s` command. If `param2 = 0`, then the specified input (`param1`) will be routed to all outputs. Up to eight inputs can be specified at a time (`param2 - param9`).

Syntax

```
r param1 param2 [...param9]
```

Parameters

<code>param1</code>	Integer	[1 ... 8]
<code>param2</code>	Integer / Character	[0, A ... H]

Examples

```
r 2 c
INPUT 2 IS ROUTED TO OUTPUT C
```

```
r 5 a b f g h
INPUT 5 IS SET TO OUTPUTS A, B, F, G, H
```

```
r 3 0
INPUT 3 IS SET TO ALL OUTPUTS.
```

Related Commands

```
#show_r
m
n
s
```

S

The `s` command routes the specified input to *all* outputs. Do not precede this command with the “#” symbol.

Syntax

```
s param1
```

Parameters

<i>param1</i>	Integer	[1 ... 8]
---------------	---------	-----------

Example

```
s 6  
INPUT 6 IS SET TO ALL OUTPUTS.
```

Related Commands

```
#show_r  
m  
n  
r
```

Using the built-in Web Server

Access the built-in Web interface by entering the IP address of the matrix that was specified in the section [IP Configuration \(page 30\)](#). Once connected to the matrix, the login screen will be displayed.

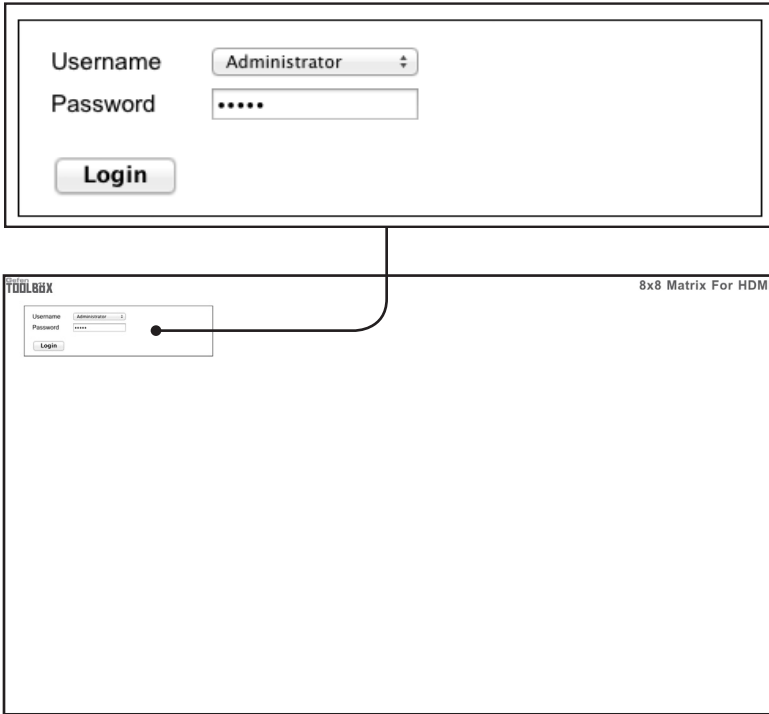

Username

Select the username from the drop-down list.

Options:

Operator, Administrator

Administrator login provides unrestricted access to all features and settings. Operator login limits access to matrix routing, display information, and routing preset features.

Password

Enter the password for the associated username. The password can also be set using RS-232 or Telnet. See the `#set_webui_ad_pass` and the `#set_webui_op_pass` commands. The password is masked when it is entered. The default password for both user names is `Admin`.

The Web GUI is divided into four main pages: **Main**, **I/O Setup**, **Manage EDID**, and **Configuration**. Each main page is represented by a tab at the top-most portion of the screen. The **Main**, **I/O Setup**, and **Manage EDID** pages have their own set of sub-tabs. Click on the desired tab / sub-tab to open the desired page.



Information

In order to view all four tabs at the top of the screen, the user must be logged in as "Administrator". If logged-in as "Operator", only the **Main** tab will be visible.

Main > Routing

Log Out

Click **Log Out** to terminate the current Web session and return to the login page.

Log Out

The screenshot shows the TOOLSBOX 8x8 Matrix For HDMI web interface. The 'Routing' tab is active, displaying a table with columns for 'Status', 'Output', and 'Input #'. A callout box highlights the 'Status' table, which is a detailed view of the routing status for each output.

Status	
Output	Input #
A	3
B	3
C	1
D	1
E	1
F	1
G	1
H	1

Output

The number of outputs that are available for routing.

Input

The input that is currently routed to the output.

TOOLBOX 8x8 Matrix For HDMI

Main I/O Setup Manage EDID Configuration Routing I/O Status Display Info

Lock Matrix

Status	Output #	Name	Output	Input #	Name
A	2	OUTPUT1	A	1	INPUT1
B	3	OUTPUT2	B	2	INPUT2
C	1	OUTPUT3	C	3	INPUT3
D	1	OUTPUT4	D	4	INPUT4
E	1	OUTPUT5	E	5	INPUT5
F	1	OUTPUT6	F	6	INPUT6
G	1	OUTPUT7	G	7	INPUT7
H	1	OUTPUT8	H	8	INPUT8
					Mask / Unmask

Check All C-Check All Route

Save & Recall Routing Presets

Save Routing Preset: [1 - Preset 1] Save

Recall Routing Preset: Preset 1 Preset 2 Preset 3 Preset 4 Preset 5 Preset 6 Preset 7 Preset 8

Outputs	
Name	Output
OUTPUT1	A <input type="checkbox"/>
OUTPUT2	B <input type="checkbox"/>
OUTPUT3	C <input type="checkbox"/>
OUTPUT4	D <input type="checkbox"/>
OUTPUT5	E <input type="checkbox"/>
OUTPUT6	F <input type="checkbox"/>
OUTPUT7	G <input type="checkbox"/>
OUTPUT8	H <input type="checkbox"/>

Inputs	
Input #	Name
<input type="radio"/> 1	INPUT1
<input type="radio"/> 2	INPUT2
<input type="radio"/> 3	INPUT3
<input type="radio"/> 4	INPUT4
<input type="radio"/> 5	INPUT5
<input type="radio"/> 6	INPUT6
<input type="radio"/> 7	INPUT7
<input type="radio"/> 8	INPUT8
<input type="radio"/>	Mask / Unmask

Route

Name (Outputs)

The name of the output.

This name can be changed using the `#set_output_name` command or through the [I/O Setup > I/O Names \(page 112\)](#) page of the Web interface.

Outputs (Outputs)

Check to select the currently active output.

Input # (Inputs)

Click the radio button next to the desired input to be routed.

Name (Inputs)

Displays the current name of the input.

This name can be changed using the `#set_input_name` command or through the [I/O Setup > I/O Names \(page 112\)](#) page of the Web interface.

Route

Click the **Route** button to route the selected input to the select output(s).

Lock Matrix

Locks / unlocks the matrix. Once the matrix is locked, settings cannot be changed using the front-panel buttons or through the Web GUI. When the matrix is locked, the button text will read “Unlock Matrix” and a red bar will appear across the top portion of the screen with the text “Matrix is LOCKED”. Click the “Unlock Matrix” button to unlock the matrix.

The screenshot shows the TOOLBOX web interface for an 8x8 Matrix For HDMI. The 'Routing' tab is active. A 'Lock Matrix' button is highlighted with a white box. A red arrow points from this button to a callout box labeled 'Lock Matrix'. Below the button is a table with columns for Status, Output, Input #, Name, Output, Input #, and Name. The table lists 8 outputs (A-H) and 8 inputs (1-8). Below the table are buttons for 'Check All', 'Clear All', and 'Route'. A 'Save & Recall Routing Presets' section is visible below the table, with a 'Save Routing Preset' button and a list of 8 presets.

The screenshot shows the TOOLBOX web interface for an 8x8 Matrix For HDMI. The 'Routing' tab is active. A red bar is visible at the top of the interface. A 'Unlock Matrix' button is highlighted with a white box. A red arrow points from this button to a callout box labeled 'Unlock Matrix'. Below the button is a table with columns for Status, Output, Input #, Name, Output, Input #, and Name. The table lists 8 outputs (A-H) and 8 inputs (1-8). Below the table are buttons for 'Check All', 'Clear All', and 'Route'. A 'Save & Recall Routing Presets' section is visible below the table, with a 'Save Routing Preset' button and a list of 8 presets.

Main > I/O Status

Output								
Name	A	B	C	D	E	F	G	H
RSENSE	Off	Off	Off	Off	Off	Off	Off	Off
Mask	Off	Off	Off	Off	Off	Off	Off	Off
HPD	Low	Low	Low	Low	Low	Low	Low	Low
HDCP	Inactive	Inactive	Inactive	Inactive	Inactive	Inactive	Inactive	Inactive

Input								
Name	1	2	3	4	5	6	7	8
Color Depth
Color Space
HDCP
ID
Active Signal
Vertical
Resolution
Input
Resolution
Progressive
Interlaced
Refresh Rate

Name	Output			
	A	B	C	D
OUTPUT1	OUTPUT2	OUTPUT3	OUTPUT4	
RSENSE	Off	Off	Off	Off
Mask	Off	Off	Off	Off
HPD	Low	Low	Low	Low
HDCP	Inactive	Inactive	Inactive	Inactive

Output

Displays the state of each output for each of the following: Name, RSENSE, Mask, HPD (Hot-Plug Detect), HDCP, and Video Mode.

Name

Displays the name of the output. The name of the output can be changed using the `#set_output_name` command or through the [I/O Setup > I/O Names](#) (page 112) page of the Web interface.

RSENSE

Displays the current Rsense state.

Mask

Displays the masking state of each output.

HPD

Displays the Hot-Plug Detect (HPD) state of each output.

HDCP

Indicates if HDCP-detection is enabled or disabled on each output.

Video Mode

Displays the current output video mode.

TOOLBOX 8x8 Matrix For HDMI

Main | I/O Setup | Manage EDID | Configuration Log Out

Routing | I/O Status | Display Info

Output								
	A	B	C	D	E	F	G	H
Name	OUTPUT1	OUTPUT2	OUTPUT3	OUTPUT4	OUTPUT5	OUTPUT6	OUTPUT7	OUTPUT8
RESIZE	Off	Off	Off	Off	Off	Off	Off	Off
Mask	Off	Off	Off	Off	Off	Off	Off	Off
HPD	Low	Low	Low	Low	Low	Low	Low	Low
HDCP	Inactive	Inactive	Inactive	Inactive	Inactive	Inactive	Inactive	Inactive

Input								
	1	2	3	4	5	6	7	8
Name	INPUT1	INPUT2	INPUT3	INPUT4	INPUT5	INPUT6	INPUT7	INPUT8
Color Depth	-	-	-	-	-	-	-	-
Color Space	-	-	-	-	-	-	-	-
HDCP	No	No	No	No	No	No	No	No
3D	No	No	No	No	No	No	No	No
Active Signal	No	No	No	No	No	No	No	No
Vertical Resolution	-	-	-	-	-	-	-	-
Horizontal Resolution	-	-	-	-	-	-	-	-
Progressive / Interlaced	-	-	-	-	-	-	-	-
Refresh Rate	-	-	-	-	-	-	-	-

Input					
	1	2	3	4	
Name	INPUT1	INPUT2	INPUT3	INPUT4	IN
Color Depth	-	-	-	-	-
Color Space	-	-	-	-	-
HDCP	No	No	No	No	No
3D	No	No	No	No	No
Active Signal	No	No	No	No	No
Vertical Resolution	-	-	-	-	-
Horizontal Resolution	-	-	-	-	-
Progressive / Interlaced	-	-	-	-	-
Refresh Rate	-	-	-	-	-

Input

Displays the state of each input for each of the following: Input name, Color Depth, Color Space, HDCP, 3D, Active Signal, Vertical Resolution, Horizontal Resolution, Progressive / Interlaced, Refresh Rate, and Video Mode.

Main > Display Info

Choose EDID Default EDID ▾

TOOLBOX 8x8 Matrix For HDMI Log Out

Main I/O Setup Manage EDID Configuration

Routing I/O Status **Display Info**

Choose EDID Default EDID ▾

Feature	
24Hz Frame Rate	TRUE
Max Resolution	1080P@60Hz
Max Color Depth	12 bit
3D Capable	FALSE
Mode (DVI/HDMI)	HDMI
Max Audio Channels	2 Ch
Monitor Name	HDMI-DA
Audio Formats	
LPCM	TRUE
DTS-HD	FALSE
DTS Digital Surround	FALSE
Dolby Digital (AC3)	FALSE
Dolby TrueHD	FALSE

Choose EDID

Select the EDID from the drop-down list. The selected EDID will be copied from the Output or selected EDID Bank to the desired input(s) and used by the source.

Options

1 - Bank1 ... 8 - Bank8

A - Output1 ... H - Output8

Feature / Audio Formats

Displays the capabilities of the display (or sink device), based on the EDID.

I/O Setup > Preset Names

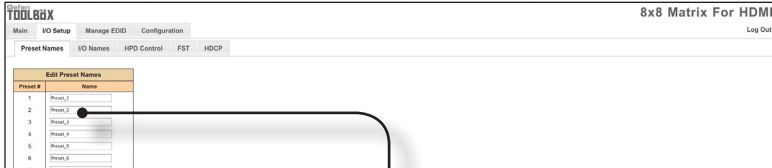

Edit Preset Names	
Preset #	Name
1	<input type="text" value="Preset_1"/>
2	<input type="text" value="Preset_2"/>
3	<input type="text" value="Preset_3"/>
4	<input type="text" value="Preset_4"/>
5	<input type="text" value="Preset_5"/>
6	<input type="text" value="Preset_6"/>
7	<input type="text" value="Preset_7"/>
8	<input type="text" value="Preset_8"/>

Preset #

The number of each preset.

Name

Type the desired name of each preset in these fields.

Save Changes

Saves the current changes to the name of the preset(s).

Cancel

Restores the previous name or each preset, if a change was made.

I/O Setup > I/O Names

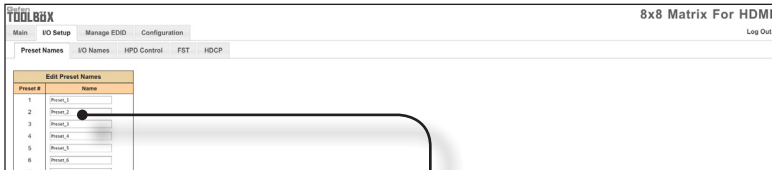

Edit Preset Names	
Preset #	Name
1	<input type="text" value="Preset_1"/>
2	<input type="text" value="Preset_2"/>
3	<input type="text" value="Preset_3"/>
4	<input type="text" value="Preset_4"/>
5	<input type="text" value="Preset_5"/>
6	<input type="text" value="Preset_6"/>
7	<input type="text" value="Preset_7"/>
8	<input type="text" value="Preset_8"/>

Output

The number of the output.

Name (Output)

Type the desired name of each output in these fields.

Input #

The number of each input.

Name (Input #)

Type the desired name of each the input in these fields.

Save Changes

Saves the current changes to the name of the output and/or input(s).

Cancel

Restores the previous name or each output and/or input(s), if a change was made.

I/O Setup > HPD Control

HPD Control		
Input #	Name	
1	INPUT1	Pulse
2	INPUT2	Pulse
3	INPUT3	Pulse
4	INPUT4	Pulse
5	INPUT5	Pulse
6	INPUT6	Pulse
7	INPUT7	Pulse
8	INPUT8	Pulse

Input #

The number of the input.

Name

The name of the input. The name of each input can be changed using the `#set_input_name` command or through the [I/O Setup > I/O Names](#) (page 112) page of the Web interface.

Pulse

Click the Pulse button to cycle the HPD line on the desired input. This is the equivalent of physically disconnecting and reconnecting the HDMI cable between the source device and the matrix.

I/O Setup > FST

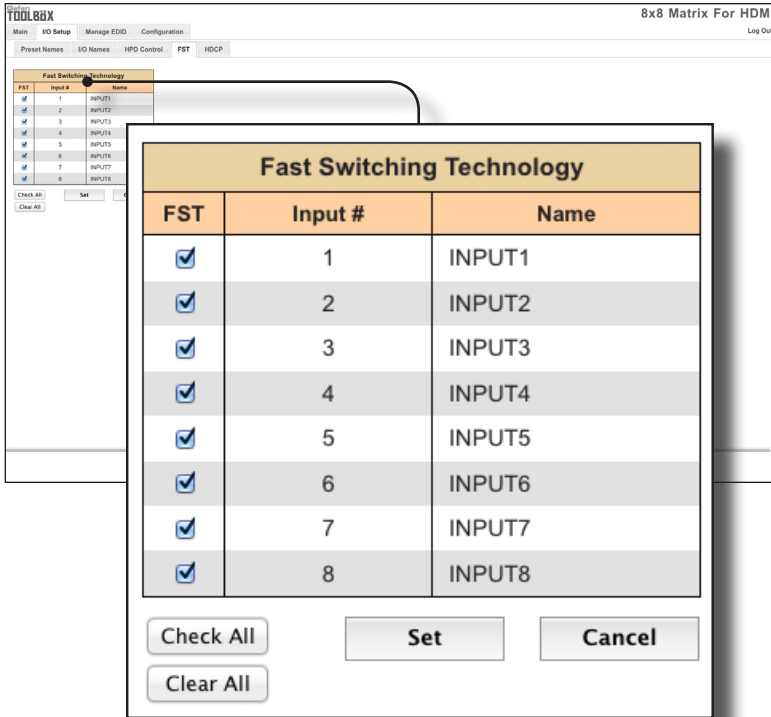
**FST**

Displays the switching state of each input.

Input #

The name of the input.

Name

The name of the input. The name of each input can be changed using the `#set_input_name` command or through the I/O Setup ► I/O Names page of the Web interface.

Check All

Selects all FST check boxes.

Set

Saves the current FST settings.

Clear All

Deselects all FST check boxes.

Cancel

Cancels any FST changes.

I/O Setup > HDCP



Information

Some computers will enable HDCP if an HDCP-compliant display is detected. Check the box under the Disable column to force the computer to ignore detection of an HDCP-compliant display. The Disable feature does not decrypt HDCP content.

HDCP Pass Through		
Disable	Input #	Name
<input type="checkbox"/>	1	INPUT1
<input type="checkbox"/>	2	INPUT2
<input type="checkbox"/>	3	INPUT3
<input type="checkbox"/>	4	INPUT4
<input type="checkbox"/>	5	INPUT5
<input type="checkbox"/>	6	INPUT6
<input type="checkbox"/>	7	INPUT7
<input type="checkbox"/>	8	INPUT8

Buttons: Check All, Clear All, Set, Cancel

Disable

Check the box under the Disable column to force the computer to ignore HDCP-detection.

Input #

The number of the input.

Name

The name of the input. The name of each input can be changed using the `#set_input_name` command or through the [I/O Setup > I/O Names](#) page of the Web interface.

Check All

Places a check mark in all boxes under the Disable column.

Clear All

Clears all check marks from the Disable column.

Set

Click this button to save changes for all input(s).

Cancel

Cancels the current operation and ignores changes for each input, if a change was made.

Manage EDID > Assign

Lock EDID

Secures the Local EDID and disables automatic EDID loading during power-up.

If the **Lock EDID** button is clicked (enabled), the “EDID locked on power cycle” message will be displayed in red. The local EDID information will now be locked once the matrix is rebooted. Click the **Unlock EDID** button to disable the Lock EDID feature.

The screenshot shows the 'TOOLBOX' interface for an '8x8 Matrix For HDMI'. The 'Assign' tab is active, showing a 'Copy EDID From' dropdown menu set to 'Default EDID'. The interface includes two tables: 'Inputs' and 'Banks'.

Copy To	EDID Model	Input #	Name	EDID Source	EDID Name
<input type="checkbox"/>	Custom - 1	1	INPUT1	OUTPUT1	LD-2240
<input type="checkbox"/>	Custom - 1	2	INPUT2	OUTPUT1	LD-2240
<input type="checkbox"/>	Custom - 1	3	INPUT3	OUTPUT1	LD-2240
<input type="checkbox"/>	Custom - 2	4	INPUT4	OUTPUT1	LD-2240
<input type="checkbox"/>	Custom - 2	5	INPUT5	OUTPUT1	LD-2240
<input type="checkbox"/>	Custom - 1	6	INPUT6	OUTPUT1	LD-2240
<input type="checkbox"/>	Custom - 1	7	INPUT7	OUTPUT1	LD-2240
<input type="checkbox"/>	Custom - 1	8	INPUT8	OUTPUT1	LD-2240

Copy To	Input #	Name	EDID Name
<input type="checkbox"/>	1	Bank 1	N/A
<input type="checkbox"/>	2	Bank 2	N/A
<input type="checkbox"/>	3	Bank 3	N/A
<input type="checkbox"/>	4	Bank 4	N/A
<input type="checkbox"/>	5	Bank 5	N/A
<input type="checkbox"/>	6	Bank 6	N/A
<input type="checkbox"/>	7	Bank 7	N/A
<input type="checkbox"/>	8	Bank 8	N/A

Buttons: Check All, Clear All, Copy, Cancel

Copy EDID From: Default EDID

Copy EDID From

Select the EDID from the drop-down list. The EDID will be copied from the Output or selected EDID bank to the destination

Options

1 - Bank1 ... 8 - Bank8

A - Output1 ... H - Output2

Inputs				
Copy To	EDID Modes	Input #	Name	EDID Source
<input type="checkbox"/>	Custom ▾	1	INPUT1	OUTPUT1
<input type="checkbox"/>	Custom ▾	2	INPUT2	OUTPUT1
<input type="checkbox"/>	Custom ▾	3	INPUT3	OUTPUT1
<input type="checkbox"/>	Custom ▾	4	INPUT4	OUTPUT1
<input type="checkbox"/>	Custom ▾	5	INPUT5	OUTPUT1
<input type="checkbox"/>	Custom ▾	6	INPUT6	OUTPUT1
<input type="checkbox"/>	Custom ▾	7	INPUT7	OUTPUT1
<input type="checkbox"/>	Custom ▾	8	INPUT8	OUTPUT1

Lock EDID

Copy EDID From: (Initial EDID)

Copy EDID To - Please select from the Inputs/Banks below

Inputs					
Copy To	EDID Modes	Input #	Name	EDID Source	EDID Name
<input type="checkbox"/>	Custom (1)	1	INPUT1	OUTPUT1	LD-2240
<input type="checkbox"/>	Custom (2)	2	INPUT2	OUTPUT1	LD-2240
<input type="checkbox"/>	Custom (3)	3	INPUT3	OUTPUT1	LD-2240
<input type="checkbox"/>	Custom (4)	4	INPUT4	OUTPUT1	LD-2240
<input type="checkbox"/>	Custom (5)	5	INPUT5	OUTPUT1	LD-2240
<input type="checkbox"/>	Custom (6)	6	INPUT6	OUTPUT1	LD-2240
<input type="checkbox"/>	Custom (7)	7	INPUT7	OUTPUT1	LD-2240
<input type="checkbox"/>	Custom (8)	8	INPUT8	OUTPUT1	LD-2240

Check All
 Clear All

Banks			
Copy To	Input #	Name	EDID Name
<input type="checkbox"/>	1	Bank 1	N/A
<input type="checkbox"/>	2	Bank 2	N/A
<input type="checkbox"/>	3	Bank 3	N/A
<input type="checkbox"/>	4	Bank 4	N/A
<input type="checkbox"/>	5	Bank 5	N/A
<input type="checkbox"/>	6	Bank 6	N/A
<input type="checkbox"/>	7	Bank 7	N/A
<input type="checkbox"/>	8	Bank 8	N/A

Check All
 Clear All

Copy To

Place a check mark in the desired check box to select or deselect the desired input(s). These check-boxes can only be used when the EDID Mode is set to Custom - User.

EDID Modes

Select the EDID mode from the drop-down list.

Options

Custom - Last Output
Custom - User

See the next page for more information on using EDID Modes.

Internal - 1080p 2 ch audio

This mode can be used as a generic EDID. Resolutions up to 1080p Full HD are supported along with 2-channel audio.

Internal - 1080p Multi ch

Same as above except with multichannel audio support.

External - Output1

Uses the (downstream) EDID of the sink device connected to Output 1.

Custom - Last Output

Uses the EDID from the last output on the matrix. For example, this matrix has a total of two outputs. If a sink device is connected to *both* **Out 1** and **Out 2**, then the matrix will use the EDID from the sink that is connected to **Out 2**. Likewise, if a sink device is connected *only* to **Out 2**, then the EDID from **Out 2** will be used. Alternatively, if a sink device is connected *only* to **Out 1**, then the EDID from **Out 1** will be used.

Custom - User

Used to select an EDID from the desired bank and copy it to an input. To do this, select the bank from the **Copy EDID From** drop-down list. Next, select **Custom - User** for the desired input, under the **EDID Modes** column. Finally, place a check mark in the **Copy To** check box, then click the **Copy** button.

Inputs				
s	Input #	Name	EDID Source	EDID Name
<input type="checkbox"/>	1	INPUT1	OUTPUT1	LD-2240
<input type="checkbox"/>	2	INPUT2	OUTPUT1	LD-2240
<input type="checkbox"/>	3	INPUT3	OUTPUT1	LD-2240
<input type="checkbox"/>	4	INPUT4	OUTPUT1	LD-2240

Input #

The number of the input.

Name

The name of the input. The name of the input can be changed using the `#set_input_name` command or through the [I/O Setup ► I/O Names](#) page of the Web interface.

EDID Source

The current EDID source being used.

EDID Name

The name of the EDID.

Clear All

Clears all check marks from the **Copy To** column.

Manage EDID > Bank Names

The screenshot shows the 'Edit Banks Names' dialog box in the TOOLBOX web interface. The dialog box has a title bar with 'Edit Banks Names' and a close button. Below the title bar is a table with two columns: 'Bank #' and 'Name'. The 'Name' column contains text input fields for each bank, currently showing 'Bank 1' through 'Bank 8'. Below the table are 'Save Changes' and 'Cancel' buttons. A callout line points from the 'Bank 1' input field in the dialog to the 'Bank 1' row in the background table.

Bank #	Name
1	Bank 1
2	Bank 2
3	Bank 3
4	Bank 4
5	Bank 5
6	Bank 6
7	Bank 7
8	Bank 8

Bank

Indicates the EDID bank number.

Name

Type the desired name of the EDID bank in this field.

Save Changes

Saves the current name change to the EDID bank(s).

Cancel

Restores the previous names for each EDID bank, if changes were made.

Manage EDID > Upload/Download

Browse...

Click this button to select the EDID file to be uploaded.

Select Bank Location

Click this drop-down list to select the bank to where the EDID will be uploaded.

Options

1 - Bank 1 ... 8 - Bank 8

Upload

Click this button to upload the EDID to the specified bank.

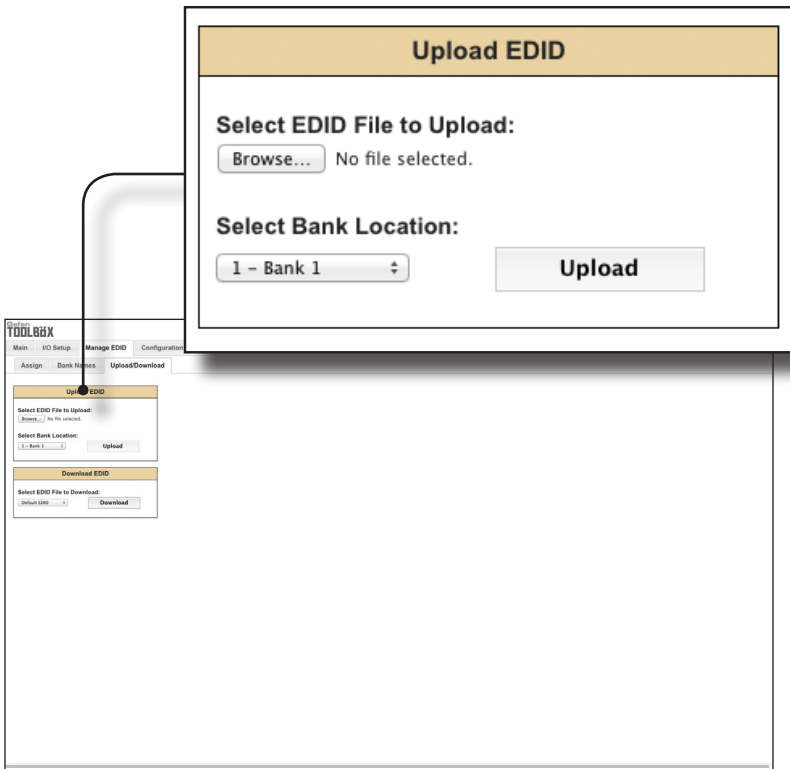

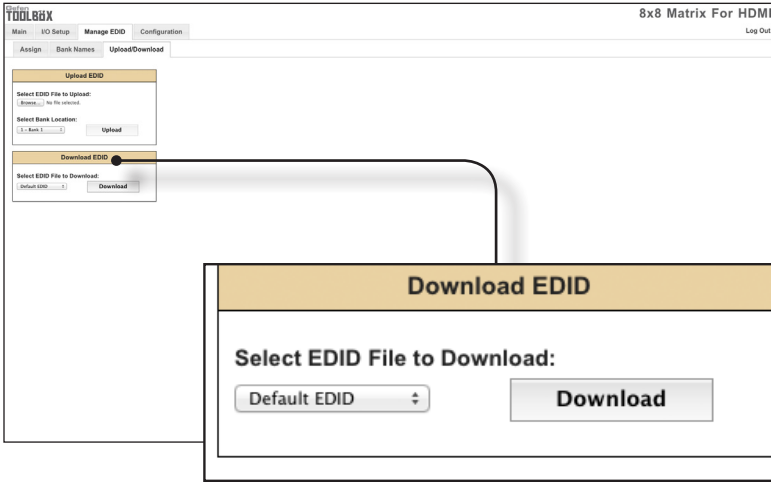

Select EDID File to Download

Click this box to select the EDID that is to be saved to a file. The EDID file will be saved in binary (.bin) format.

Options

1 - Bank 1 ... 8 - Bank 8
A - OUTPUT1 ... H - OUTPUT8
1 - INPUT1 ... 8 - INPUT8

Download

Click this button to download the selected EDID to a file.

Configuration > Change IP Settings

The screenshot shows a web interface for configuring an 8x8 Matrix For HDMI. The main navigation bar includes 'Main', 'IO Setup', 'Manage EDD', and 'Configuration'. The 'Change IP Settings' dialog box is open, displaying the following configuration details:

Field	Value
MAC Address:	00:1a:07:11:01:76
IP Address:	10.5.64.247
Subnet:	255.255.255.0
Gateway:	10.5.64.1
Port:	80
TCP/Telnet Terminal Port:	23
UDP Port:	50007

At the bottom of the dialog box, there are two buttons: 'Save Settings' and 'Set Defaults'.

Change IP Settings

Assigns the IP address, subnet, gateway, HTTP listening port, Telnet port, and UDP port. The MAC address cannot be changed.

Save Settings

Saves the current settings for the Change IP Settings. After clicking this button, the Web interface will display a dialog indicating that the matrix must be rebooted for changes to take effect.

Set Defaults

Click this button to restore the factory-default IP settings. After clicking this button, the Web interface will display a dialog indicating that the matrix must be rebooted for changes to take effect.

Configuration > Telnet Login Settings

The screenshot shows the 'Telnet Login Settings' configuration page. The page is titled 'Telnet Login Settings' and contains several input fields and checkboxes. A 'Save Settings' button is located at the bottom right.

Telnet Login Settings

Old Password:

New Password:

Confirm New Password:

Force Password on Connect:

Show Login Message on Connect:

Save Settings

Old Password

Type the current (old) password in this field.

New Password

Type the new password in this field.

Force Password on Connect

Click this check box to have the matrix prompt for a password each time a Telnet session is started. This box *must* be checked in order to change the Telnet Login credentials.

Show Login Message on Connect

Click this check box to have the matrix display the Telnet welcome message each time a Telnet session is started. The welcome message appears as: "Welcome to GTB-HD4K2K-848 TELNET".

Save Settings

Saves the current changes to the Telnet Login Settings.

Configuration > UDP Connection Settings

The screenshot shows the TOOLBOX web interface with the following sections:

- Change IP Settings:**
 - MAC Address: 00:1a:07:11:01:78
 - IP Address: 192.168.1.80
 - Subnet: 255.255.255.0
 - Gateway: 192.168.1.1
 - Port: 88
 - TCP/Shell Terminal Port: 22
 - UDP Port: 50007
 - Buttons: Save Settings, Set Defaults
- Telnet Login Settings:**
 - Old Password: [text box]
 - New Password: [text box]
 - Confirm New Password: [text box]
 - Force Password on Connect:
 - Show Login Message on Connect:
 - Button: Save Settings
- UDP Connection Settings (Callout Box):**
 - Remote UDP IP Address: 192.168.1.80
 - Remote UDP Port: 50008
 - Enable UDP Access:
 - Button: Save Settings

Remote UDP IP Address

Type the remote UDP IP address in this text box.

Remote UDP Port

Enter the remote UDP port in this text box.

Enable UDP Access

Check this box to enable UDP access. If this box is unchecked, the UDP access will be unavailable.

Configuration > Web Login Settings

Web Login Settings

Username:

Old Password:

New Password:

Confirm New Password:

Save Settings

Telnet Login Settings

Old Password:

New Password:

Confirm New Password:

Force Password on Connect:

Show Login Message on Connect:

UDP Connection Settings

Remote UDP IP Address:

Remote UDP Port:

Enable UDP Access:

Web Login Settings

Username:

Old Password:

New Password:

Confirm New Password:

System Configuration

Download Current Configuration

Restore Configuration
 No file selected.

Warning: All current settings will be lost.

Firmware Update (3.0 ver - v3.20)
 No file selected.

Factory Reset

Reboot

Username

Click this drop-down list to select the user name. The credentials for the selected user name can now be changed.

Old Password

Type the current (old) password in this field.

New Password

Type the new password in this field.

Confirm Password

Re-type the new password in this field.

Save Settings

Saves the current changes to the Web Login Settings.

Configuration > System Configuration

System Configuration

Download Current Configuration	<input type="button" value="Download"/>
Restore Configuration <input type="button" value="Browse..."/> No file selected.	
<i>Warning: All current settings will be lost</i>	<input type="button" value="Restore"/>
Firmware Update (UI ver: v3.2B) <input type="button" value="Browse..."/> No file selected.	<input type="button" value="Update"/>
Factory Reset	<input type="button" value="Reset"/>
Reboot	<input type="button" value="Reboot"/>

[Save Settings](#)

UDP Connection Settings

Rename UDP IP Address:	<input style="width: 80%;" type="text" value="192.168.1.10"/>
Rename UDP Port:	<input style="width: 80%;" type="text" value="5000"/>
Enable UDP Access:	<input type="checkbox"/>

[Save Settings](#)

Web Login Settings

Username:	<input style="width: 80%;" type="text" value="Operator"/>
Old Password:	<input style="width: 80%;" type="password"/>
New Password:	<input style="width: 80%;" type="password"/>
Confirm New Password:	<input style="width: 80%;" type="password"/>

[Save Settings](#)

System Configuration

Download Current Configuration	<input type="button" value="Download"/>
Restore Configuration <input type="button" value="Browse..."/> No file selected.	
<i>Warning: All current settings will be lost</i>	<input type="button" value="Restore"/>
Firmware Update (UI ver: v3.2B) <input type="button" value="Browse..."/> No file selected.	<input type="button" value="Update"/>
Factory Reset	<input type="button" value="Reset"/>
Reboot	<input type="button" value="Reboot"/>

Download

Click this button to download the current matrix configuration to a file.

(continued on next page)

System Configuration

Download Current Configuration	<input type="button" value="Download"/>
Restore Configuration	
<input type="button" value="Browse..."/> No file selected.	
<i>Warning: All current settings will be lost</i>	<input type="button" value="Restore"/>
Firmware Update (UI ver: v3.2B)	
<input type="button" value="Browse..."/> No file selected.	<input type="button" value="Update"/>
Factory Reset	<input type="button" value="Reset"/>
Reboot	<input type="button" value="Reboot"/>

Browse

Click this button to select the firmware file to be uploaded. See [Upgrading using the Web interface](#) for details on updating the firmware.

Browse

Click this button to select the saved configuration file to be loaded into memory.

Restore

Uploads the selected configuration file to the matrix.

Update

Updates the matrix with the selected firmware file.

This page left intentionally blank.

4K Ultra HD 8x8 Matrix for HDMI

4

Appendix

Mounting Instructions

The matrix can be mounted vertically in a wall or cabinet with wood/drywall screws as shown in the diagram above. There should be an inch or two of clearance between the edges of the unit and any walls or vertical surfaces to allow for enough clearance for insertion and retraction of cables at the HDMI connectors.

For installation on a drywall surface, use a #6 drywall screw. It is recommended when installing on a drywall surface that studs be used to secure the matrix should undue stress be applied when connecting and disconnecting HDMI cables.

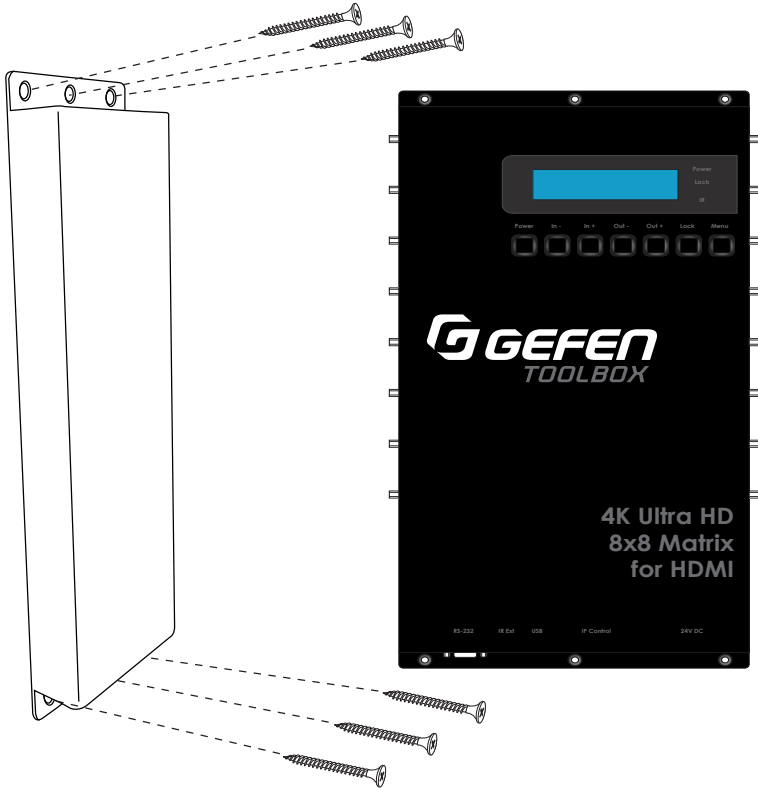

The firmware for the 4K Ultra HD 8x8 Matrix for HDMI can be upgraded using one of the following methods: 1) Using the Web interface. 2) Using the USB port. The first method is covered below. See the next page for details on upgrading the matrix using the USB port.

Upgrading using the Web interface



Important

DO NOT power-off or disconnect the AC power cord from the matrix during the firmware upgrade process.

1. Download the firmware from the Support section of the Gefen Web site.
2. Extract the firmware file from the .ZIP file.
3. Power-ON the 4K Ultra HD 8x8 Matrix for HDMI.
4. Connect a CAT-5 (or better) cable between the matrix and the computer running the Web interface.

It is unnecessary to disconnect any video cables or extenders from the 4K Ultra HD 8x8 Matrix for HDMI during the update process.

5. Click the **Configuration** tab in the Web interface and click the **Browse...** button under the **System Configuration** section.
6. Select the firmware file and click the **Update** button.
7. The matrix will display a prompt to verify that the current firmware will be overwritten. Click the **OK** button on the dialog box to begin uploading the firmware file.
8. The matrix will begin the upgrade process. This process will take several minutes. The upgrade process may be monitored using the RS-232 interface.
9. After the matrix has been updated, the unit will automatically initiate a countdown to reboot.
10. After the matrix reboots, the firmware upgrade process will be complete.

Upgrading using the USB port



Important

DO NOT power-off or disconnect the AC power cord from the matrix during the firmware upgrade process.

1. Download the firmware from the Support section of the Gefen Web site.
2. Power-ON the 4K Ultra HD 8x8 Matrix for HDMI.
3. Connect a USB cable between the computer and the 4K Ultra HD 8x8 Matrix for HDMI.

It is unnecessary to disconnect any video cables or extenders from the 4K Ultra HD 8x8 Matrix for HDMI during the update process.

4. Once the computer is able to connect to the 4K Ultra HD 8x8 Matrix for HDMI, a removable-disk icon will be displayed under My Computer.
5. Extract the firmware file from the .ZIP file and drag the .bin file to the Removable Disk.
6. Disconnect the USB cable from the matrix.
7. The matrix will begin the software upgrade procedure. This process may take a few minutes. *Do not* disconnect power from the matrix during the upgrade procedure.
8. Once the firmware upgrade process has completed, the matrix will automatically reboot.

Connectors, Controls, and Indicators

Video Input	• 8 x HDMI Type A, 19-pin, female, locking
Video Output	• 8 x HDMI Type A, 19-pin, female, locking
USB	• 1 x Mini-B
RS-232	• 1 x DB-9, female
Ethernet	• 1 x RJ-45
Power Receptacle	• 1 x 4-pin, locking
IR Sensor	• 1 x located on front panel
IR Extender	• 3.5mm mini-stereo
Power Indicator	• 1 x LED, bi-color, red / green
Lock Indicator	• 1 x LED, orange
Display	• 1 x 2-row, 16-character
Control Buttons	• 7 x tact-type

Operational

Maximum Pixel Clock	• 300 MHz
Power Supply	• 24V DC
Power Consumption	• 27W maximum
Operating Temperature	• +32 to +122 °F (0 to +50 °C)
Operating Humidity	• 5% to 90% RH, non-condensing
Storage Temperature	• -4 to +140 °F (-20 to +60 °C)
Storage Humidity	• 5% to 95% RH, non-condensing
MTBF	• 50000 hours

Physical

Dimensions (W x H x D)	• 9.3" x 17.9" x 1.75" (236mm x 454mm x 44mm)
Unit Weight	• 3.9 lbs. (1.8 kg)



20600 Nordhoff St., Chatsworth CA 91311
1-800-545-6900 818-772-9100 fax: 818-772-9120
www.gefen.com support@gefen.com