



4K ULTRA HD
60Hz, 4:2:0

HDBaseT™ Extender w/ 2-way IR and POH

GTB-UHD-HBTL

User Manual



Release A1

Important Safety Instructions

1. Read these instructions.
2. Keep these instructions.
3. Heed all warnings.
4. Follow all instructions.
5. Do not use this product near water.
6. Clean only with a dry cloth.
7. Do not block any ventilation openings. Install in accordance with the manufacturer's instructions.
8. Do not install or place this product near any heat sources such as radiators, heat registers, stoves, or other apparatus (including amplifiers) that produce heat.
9. Do not defeat the safety purpose of the polarized or grounding-type plug. A polarized plug has two blades with one wider than the other. A grounding type plug has two blades and a third grounding prong. The wide blade or the third prong are provided for your safety. If the provided plug does not fit into your outlet, consult an electrician for replacement of the obsolete outlet.
10. Protect the power cord from being walked on or pinched particularly at plugs, convenience receptacles, and the point where they exit from the apparatus.
11. Only use attachments/accessories specified by the manufacturer.
12. To reduce the risk of electric shock and/or damage to this product, never handle or touch this unit or power cord if your hands are wet or damp. Do not expose this product to rain or moisture.
13. Unplug this apparatus during lightning storms or when unused for long periods of time.
14. Refer all servicing to qualified service personnel. Servicing is required when the apparatus has been damaged in any way, such as power-supply cord or plug is damaged, liquid has been spilled or objects have fallen into the apparatus, the apparatus has been exposed to rain or moisture, does not operate normally, or has been dropped.
15. Batteries that may be included with this product and/or accessories should never be exposed to open flame or excessive heat. Always dispose of used batteries according to the instructions.

Warranty Information

Gefen/Core Brands, LLC warrants the equipment it manufactures to be free from defects in material and workmanship. If equipment fails because of such defects and Gefen LLC is notified within the specified warranty period* from the documented** date of purchase, Gefen will, at its option, repair or replace the equipment, provided that the equipment has not been subjected to mechanical, electrical, or other abuse or modifications. This warranty is in lieu of all other warranties expressed or implied, including without limitation, any implied warranty or merchantability or fitness for any particular purpose, all of which are expressly disclaimed. Warranty period begins on the date of purchase by the original end-purchaser, as indicated on the proof of purchase document**. This Limited Warranty extends to the original end-user purchaser of the product, and is not transferrable to any subsequent purchaser(s) or owner(s). Customers outside the continental United States of America are responsible for shipping charges to and from Gefen.

* Warranty period:

Passive Copper Cables without any electronic circuitry: 30 days. Cables must be in their original condition.

Electronics:

- 2 years unless specified otherwise.
- 3 years if specifically noted as such on Gefen web-page of a product. Documented** purchases made on or after March 29, 2017 only.

** Proof of purchase must be a written document, as deemed acceptable by Gefen/Core Brands, LLC.

Technical Support

(707) 283-5900 (800) 472-5555
8:00 AM to 5:00 PM Monday - Friday, Pacific Time

Email

support@gefen.com

Web

<http://www.gefen.com>

Mailing Address

Gefen
Core Brands, LLC
c/o Customer Service
1800 S McDowell Blvd
Petaluma, CA 94954 USA

Product Registration

Register your product here: <http://www.gefen.com/kvm/Registry/Registration.jsp>

- Gefen recommends using CAT-5e (or better) cables.
- Resolution will affect extension distance. 1080p Full HD can be extended up to 230 feet (70 meters). 4K resolutions can be extended up to 130 feet (40 meters). See [HDBT \(HDBaseT™\) Mode \(page v\)](#) for details.
- Power Over Line (POL) is a Gefen proprietary technology that provides power to the Receiver unit over a single CAT-5e (or better) cable. A power supply (1 pc included) can be connected to either the Sender or Receiver unit. *Never connect a power supply to both the Sender and Receiver unit.*
- This product passes through the display's EDID to the source. If the display is capable of accepting Deep Color, the source must be manually configured to output 8-bit color. This is only applicable when using 4K x 2K resolutions. See [HDBT \(HDBaseT™\) Mode \(page v\)](#) for more information.
- This product supports sources up to 4K 300 MHz (60 Hz 4:2:0 or 30 Hz 4:4:4). It is not compatible with sources that are capable of HDR or 4K 600 MHz (60 Hz 4:4:4).
- The information in this manual has been carefully checked and is believed to be accurate. However, Gefen assumes no responsibility for any inaccuracies that may be contained in this manual. In no event will Gefen be liable for direct, indirect, special, incidental, or consequential damages resulting from any defect or omission in this manual, even if advised of the possibility of such damages.
- The technical information contained herein regarding the features and specifications is subject to change without notice.
- For the latest warranty coverage information, refer to the Warranty and Return Policy under the Support section of the Gefen Web site at www.gefen.com.

© 2017 Gefen, LLC. All Rights Reserved. All trademarks are the property of their respective owners.

Gefen, LLC reserves the right to make changes in the hardware, packaging, and any accompanying documentation without prior written notice.



This product uses UL-Listed power supplies



Features

- Extends 4K Ultra HD (3840 x 2160 @ 60Hz, 4:2:0 or @ 30Hz, 4:4:4) and Bi-Directional R over a single CAT-5e cable up to 130 feet/40 meters (8-bit color)
- Extends 4K Cinema (DCI) (4096 x 2160 @ 24 or 30Hz 4:4:4), and Bi-Directional IR over a single CAT-5e cable up to 130 feet/40 meters (8-bit color)
- Extends HDMI at 1080p Full HD and Bi-Directional IR over a single CAT-5e cable up to 230 feet/70 meters (up to 12-bit Deep Color)
- HDMI Features Supported:
 - ▶ HDMI 2.0
 - ▶ HDCP 2.2 and 1.4
 - ▶ 12-bit Deep Color
 - ▶ LPCM 7.1 audio, Dolby® TrueHD, and DTS-HD Master Audio™ pass-through
 - ▶ 3DTV pass-through
 - ▶ CEC pass-through
 - ▶ Lip Sync pass-through
- IR extension from Sender to Receiver and from Receiver to Sender
- Gefen Bi-Directional POL feature provides power to the Sender or the Receiver unit over the link cable - only one side needs external power
- Uses Gefen's implementation of HDBaseT™ technology
- Advanced EDID Management
- Locking power connector
- Surface mountable

HDMI® 2.0

1080P
PROGRESSIVE



4K ULTRA HD
60Hz, 4:2:0

HDCP 2.2



Packing List

The following items are shipped with the 4K Ultra HD HDBaseT Extender w/ 2-way IR and POL. If any of these items are not present in the box when you first open it, immediately contact your dealer or Gefen.

- 1 x 4K Ultra HD HDBaseT™ Extender w/ 2-way IR and POL - Sender unit (GTB-UHD-HBTL-S)
- 1 x 4K Ultra HD HDBaseT™ Extender w/ 2-way IR and POL - Receiver unit (GTB-UHD-HBTL-R)
- 1 x 6 ft. locking HDMI cable, M-M (CAB-HD-LCK-06MM)
- 1 x IR extender (EXT-RMT-EXTIRN)
- 1 x IR emitter (EXT-IREMIT)
- 1 x 24V DC locking power supply (EXT-PS24U1AIP-6)
- 1 x Quick-Start Guide (QSG-GTB-UHD-HBT)

1 Getting Started

Introduction.....	2
Sender Unit.....	2
Receiver Unit.....	4
Installation.....	6
Connection Instructions.....	6
Sample Wiring Diagram.....	7

2 Basic Operation

LED Status.....	10
Bidirectional IR Control.....	11
Controlling the Source from the Viewing Location.....	11
Controlling the Display from the Source Location.....	12
Controlling the Source / Display from Different Locations.....	13
DIP Switch Configuration.....	14
EDID Management.....	15
HPD Mode.....	16
HDBT (HDBaseT™) Mode.....	17

3 Appendix

Surface Mounting Instructions.....	20
Network Cable Diagram.....	21
Specifications.....	22
Index.....	23

This page left intentionally blank.

This page left intentionally blank.

4K ULTRA 
60Hz, 4:2:0
HDBaseT™ Extender
w/ 2-way IR and POH

1 Getting Started

Sender Unit

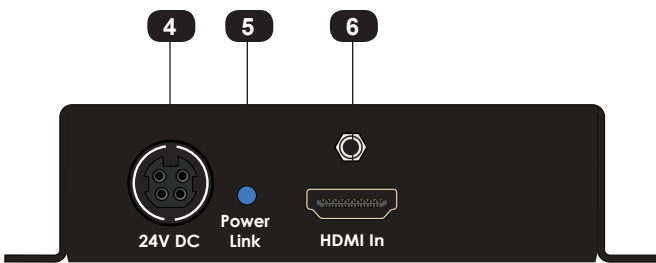
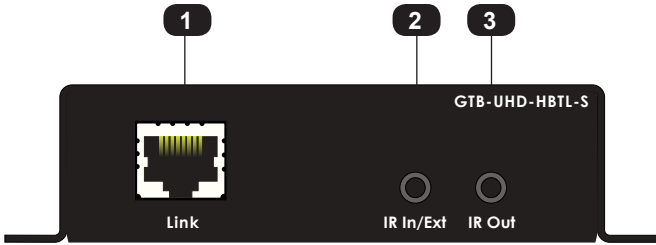

ID	Name	Description
1	Link	Connect a CAT-5e cable (or better), up to 230 feet (70 meters), from this port to the Link port on the Receiver unit.
2	IR In/Ext	3.5mm mini-stereo jack. Connect an IR Extender (Gefen part no. EXT-RMT-EXTIRN) to this port. Alternatively, connect a 3.5mm mini-stereo connector from this port to the output of an automation system with an electrical IR output. See Bidirectional IR Control (page 11) for more information on using IR.
3	IR Out	Connect an EXT-IREMIT IR Emitter (1 pc included) from this port to the IR sensor of the device to be controlled. See Bidirectional IR Control (page 11) for more information on using IR.
4	24V DC	This power receptacle can be used to connect the included 24V DC power supply. Only one power supply is required for the extender system to operate. The power supply can be connected to either the Sender or Receiver unit.
5	Power Link	This LED indicator displays the current state of the Sender unit. See LED Status (page 10) for more information.
6	HDMI In	Use the included HDMI cable to connect an Ultra Hi-Def source to this HDMI port.

Receiver Unit

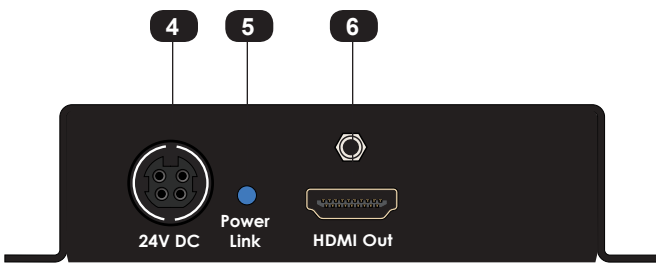
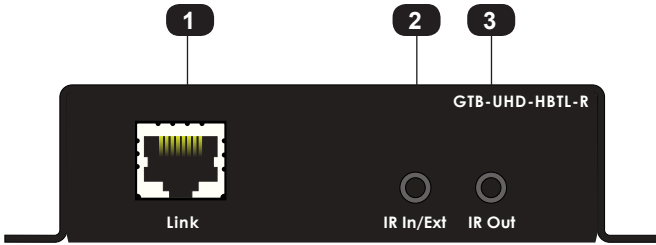

ID	Name	Description
1	Link	Connect a CAT-5e cable (or better), up to 230 feet (70 meters), from this port to the Link port on the Sender unit.
2	IR In/Ext	3.5mm mini-stereo jack. Connect an EXT-RMT-EXTIRN IR Extender (1 pc included) to this port. Alternatively, connect a 3.5mm mini-stereo connector from this port to the output of an automation system with an electrical IR output. See Bidirectional IR Control (page 11) for more information on using IR.
3	IR Out	Connect an IR emitter (Gefen part no. EXT-IREMIT) from this port to the IR sensor of the device to be controlled. See Bidirectional IR Control (page 11) for more information on using IR.
4	24V DC	This power receptacle can be used to connect the included 24V DC power supply. Only one power supply is required for the extender system to operate. The power supply can be connected to either the Sender or Receiver unit.
5	Power Link	This LED indicator displays the current state of the Receiver unit. See LED Status (page 10) for more information.
6	HDMI Out	Connect an HDMI cable from this port to an Ultra-HD display.

Connection Instructions

▶ Video

1. Connect the included HDMI cable between the Ultra Hi-Def source and the **HDMI In** port on the Sender unit.
2. Connect an Ultra HD display to the **HDMI Out** port on the Receiver unit using another HDMI cable.

▶ CAT-5

3. Connect a CAT-5e (or better) cable, up to 230 feet (70 meters) from the **Link** port on the Sender unit and the **Link** port on the Receiver unit.



Information

Resolution will affect extension distance. 1080p Full HD can be extended up to 230 feet (70 meters). 4K resolutions can be extended up to 130 feet (40 meters).

▶ IR

4. Refer to [Bidirectional IR Control \(page 11\)](#) for details on connecting IR devices.

▶ Power

5. Connect the included 24V DC power supply to the power receptacle on *either* the Sender or Receiver unit.
6. Connect the opposite end of the power supply to an available electrical outlet.

Sample Wiring Diagram

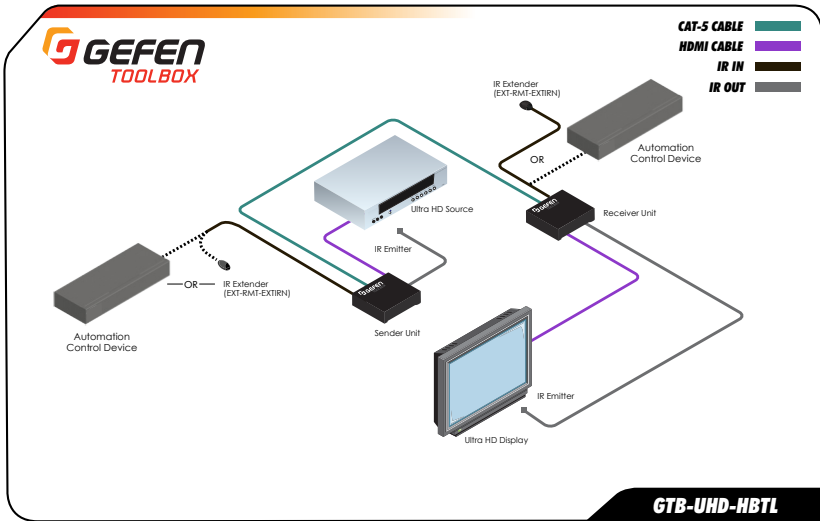

Information

The wiring diagram, shown above, requires an additional IR emitter (Gefen part no. EXT-IREMIT) and IR extender (Gefen part no. EXT-RMT-EXTIRN).



This page left intentionally blank.

4K ULTRA 
60Hz, 4:2:0
HDBaseT™ Extender
w/ 2-way IR and POH

2 Basic Operation

The **Power Link** LED indicator on the Sender and Receiver unit provides basic information on the current status of the 4K Ultra HD HDBaseT Extender w/ 2-way IR and POL.

The information, in the table below, applies to both the Sender and Receiver unit.

Status		Description
Solid blue		<ul style="list-style-type: none">The Sender / Receiver unit is powered.Link integrity between Sender and Receiver unit is good.
Solid green		<ul style="list-style-type: none">Link integrity is compromised.Check the cable between the Link port on the Sender and Receiver unit.
Flashes blue / green		<ul style="list-style-type: none">Source device is not connected to the Sender unit.Display (sink) device not connected to the Receiver unit.

Controlling the Source from the Viewing Location

1. Connect an EXT-RMT-EXTIRN IR Extender (1 pc included) to the **IR In/Ext** port on the Receiver unit. If using an automation system, connect the 3.5mm mini-stereo connector from the **IR In/Ext** port on the Receiver unit to the automation system. IR signals are transmitted over the Link cable.
2. Connect an EXT-IREMIT IR Emitter (1 pc included) from the **IR Out** port, on the Sender unit, to the IR sensor window on the source device.

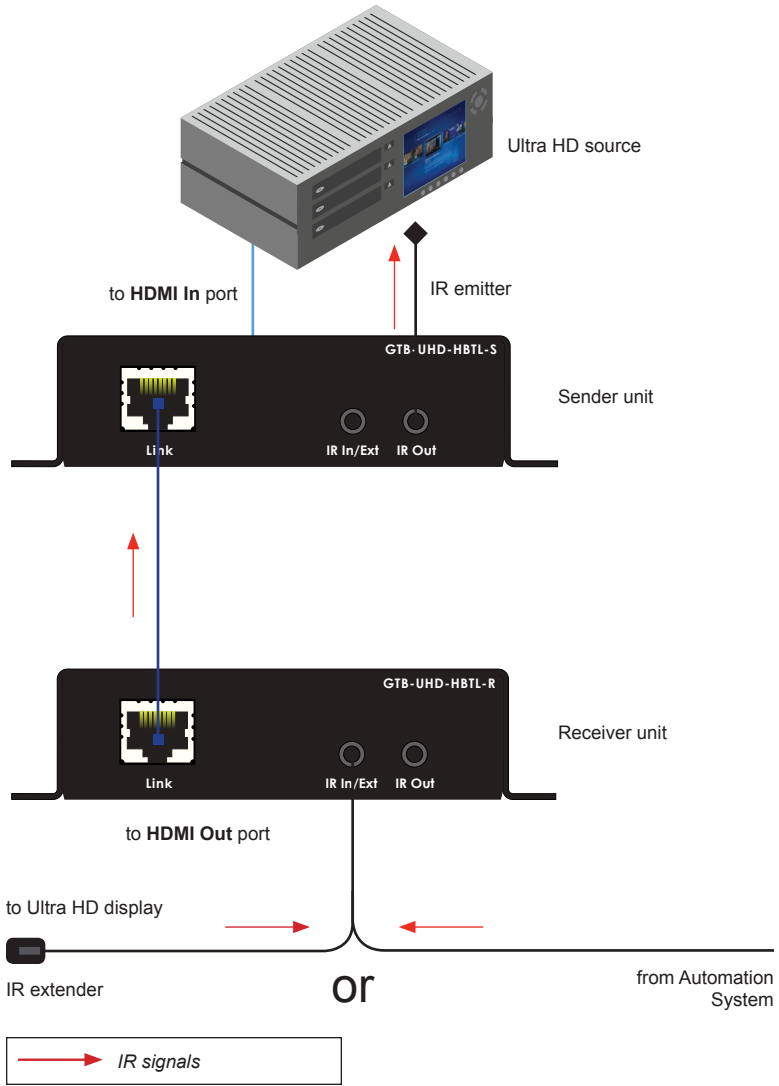

Controlling the Display from the Source Location

1. Connect an EXT-RMT-EXTIRN IR Extender (1 pc included) to the IR In/Ext port on the Sender unit. If using an automation system, connect the 3.5mm mini-stereo connector from the **IR In/Ext** port on the Receiver unit to the automation system. IR signals are transmitted over the **Link** cable.
2. Connect an EXT-IREMIT IR Emitter (1 pc included) from the **IR Out** port on the Receiver unit to the IR sensor on the display.

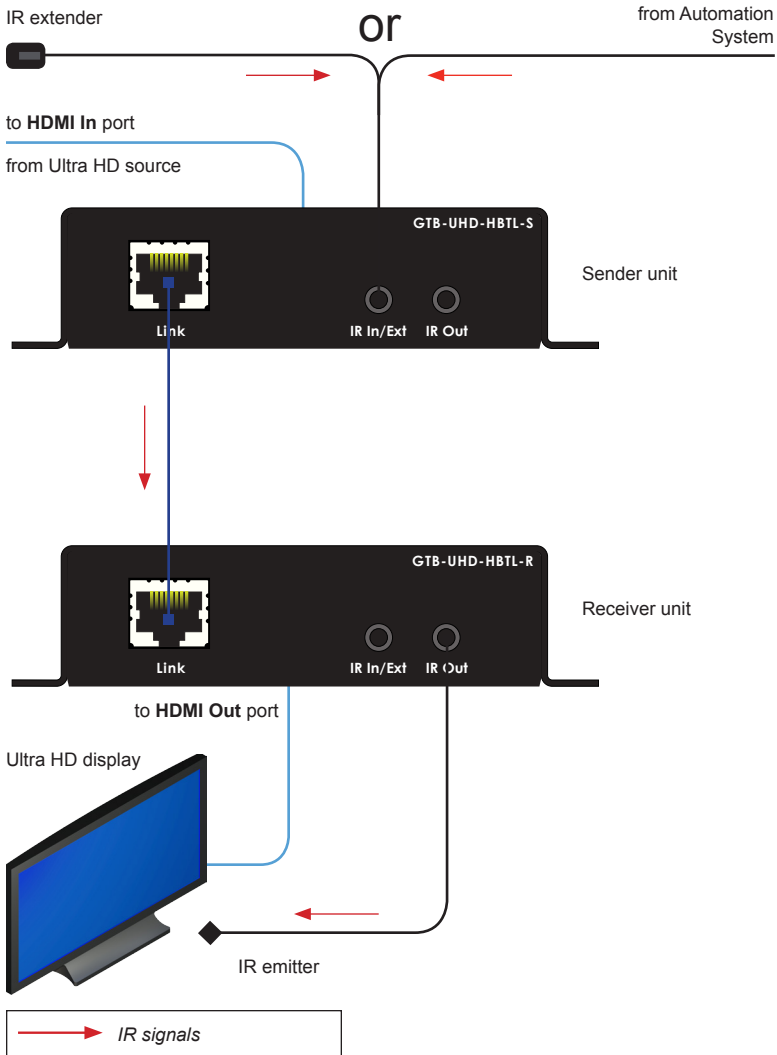

Controlling the Source / Display from Different Locations



Information

Additional IR extenders (Gefen part no. EXT-RMT-EXTIRN) and IR emitters (Gefen part no. EXT-IREMIT) will be required for this configuration.

Using bidirectional IR, the 4K Ultra HD HDBaseT Extender w/ 2-way IR and POL allows the source and/or display to be controlled from the Sender or Receiver unit. Refer to the diagram, below, for connection details. The video (HDMI) cables have been removed for clarity. IR signals are transmitted over the **Link** cable.

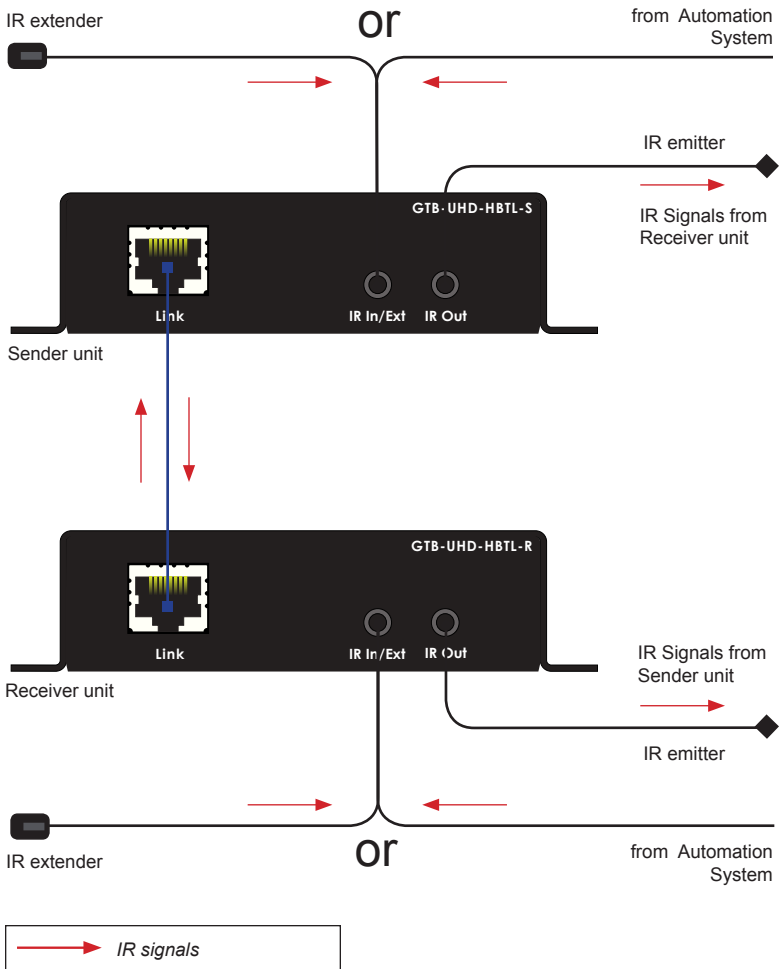

DIP Switch Configuration

On the bottom of both the Sender and Receiver unit are a set of DIP switches. The Sender unit has a bank of four DIP switches. The Receiver unit has a bank of two DIP switches. See the following pages for DIP switch settings.

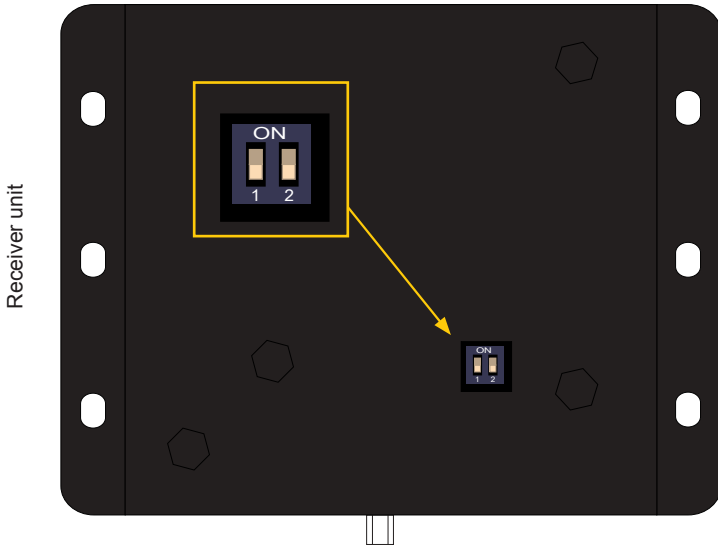
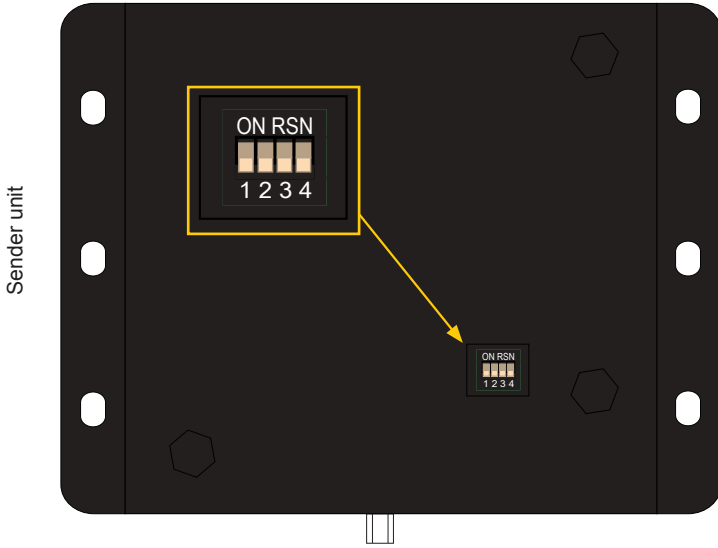

Each of the following sections describe the DIP switch settings that control each feature. DIP switches that are not related to a specific feature have been grayed-out. Note that DIP switch settings can be used independently or in conjunction with other features, as desired.



Information

DIP switch 2, on the Receiver unit, is not used and is reserved for optional future expansion.

EDID Management

The 4K Ultra HD HDBaseT Extender w/ 2-way IR and POL provides EDID management. The Sender unit can use the EDID from the sink device (downstream EDID) or modify the EDID, locally.

Description	Sender unit	Receiver unit
<p>External EDID mode (default)</p> <ul style="list-style-type: none"> Allows all video and audio features of the connected device to be passed to the source device. 		
<p>Internal EDID mode</p> <ul style="list-style-type: none"> Copies the downstream EDID locally for use with HPD High Mode. See HPD Mode (page 16) for more information. 		

HPD Mode

HPD (Hot-Plug Detect) is an HDMI feature that senses if the HDMI cable is disconnected from the source or sink device. Once this occurs, the HDMI link is re-initialized if necessary. The 4K Ultra HD HDBaseT Extender w/ 2-way IR and POL allows you to control the way HPD is handled.

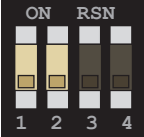
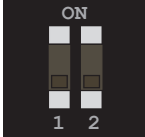
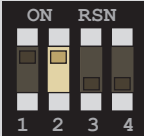
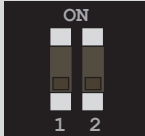
Description	Sender unit	Receiver unit
<p>HPD High</p> <ul style="list-style-type: none"> Both DIP switch 1 and 2 must be in the down (OFF) position when setting HPD high. HPD is <i>always</i> high, even when the display is hot-plugged (disconnected from then reconnected to the source device). 		
<p>HPD Pass-through</p> <ul style="list-style-type: none"> DIP switch 2 must be in the up (ON) position when setting HPD pass-through. The position of DIP switch 1 is ignored and can be in the up (ON) or down (OFF) position. HPD will toggle, depending on the HPD status of the display (sink) or source device. 		

This page left intentionally blank.

This page left intentionally blank.

4K ULTRA 
60Hz, 4:2:0
HDBaseT™ Extender
w/ 2-way IR and POH

3 **Appendix**

Surface Mounting Instructions

The Sender and Receiver units can be mounted on any flat surface, as shown below (screws not included). There should be an inch or two of clearance between the edges of the unit and any walls or vertical surfaces to allow for enough clearance for connection and disconnection of the HDMI cables.

For installation on a drywall surface, use a #6 drywall screw. When installing, it is recommended to use the center hole on a stud.

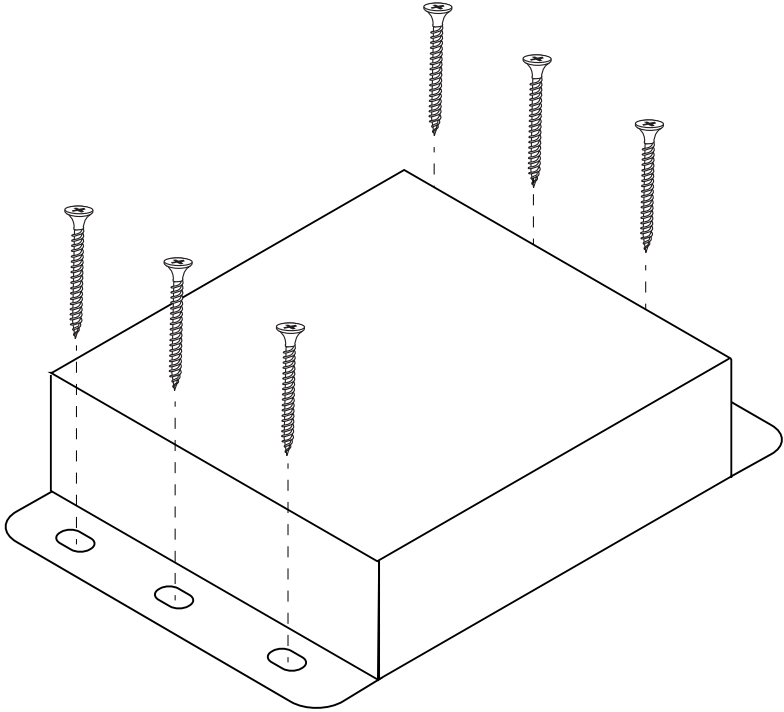

Front of RJ-45 Connector

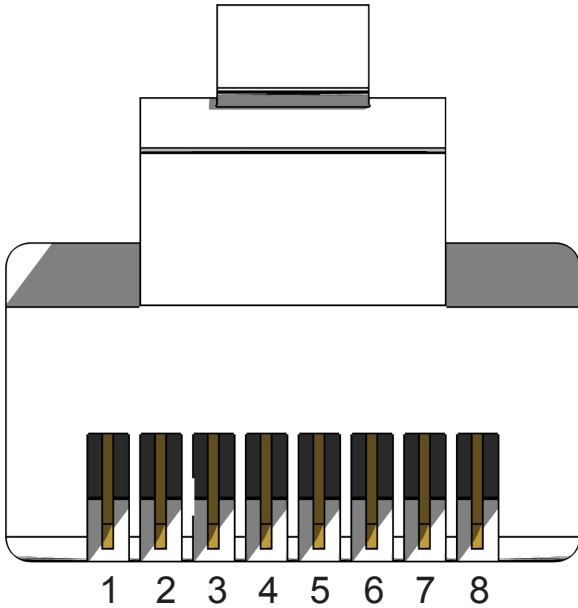

Gefen recommends the TIA/EIA-568-B wiring option. Use the following table when terminating cables in the field.

Pin	Color	Description
1	Orange / White	TD+ (Transmit Data, positive differential signal)
2	Orange	TD- (Transmit Data, negative differential signal)
3	Green / White	RD+ (Receive Data, positive differential signal)
4	Blue	Unused
5	Blue / White	Unused
6	Green	RD- (Receive Data, negative differential signal)
7	Brown / White	Unused
8	Brown / White	Unused

Shielded (STP) CAT-5 or CAT-6 is recommended. However, unshielded (UTP) CAT-5 or CAT-6 is acceptable. CAT-5, CAT-5e, and CAT-6 cabling comes in stranded and solid core types. Gefen recommends using solid core cabling. CAT-6 cable is also recommended.

It is recommended to use one continuous run from one end to the other. Patch cable is not recommended.

Supported Formats

Video	<ul style="list-style-type: none"> • 4096 x 2160 • 3840 x 2160 • 1920 x 1200 (WUXGA) • 1080p Full HD
Audio	<ul style="list-style-type: none"> • Linear PCM (7.1 channels) • Dolby Atmos® and Dolby® TrueHD • DTS:X™ and DTS-HD Master Audio™

Connectors & Indicators

HDMI In (Sender)	<ul style="list-style-type: none"> • 1 x HDMI Type A, 19-pin, female
HDMI Out (Receiver)	<ul style="list-style-type: none"> • 1 x HDMI Type A, 19-pin, female
Link (Sender / Receiver)	<ul style="list-style-type: none"> • 1 x RJ-45, shielded, female
IR In/Ext (Sender / Receiver)	<ul style="list-style-type: none"> • 1 x 3.5mm, female
IR Out (Sender / Receiver)	<ul style="list-style-type: none"> • 1 x 3.5mm, female
Power (Sender / Receiver)	<ul style="list-style-type: none"> • 1 x 4-pin, locking, female
Power Link (Sender / Receiver)	<ul style="list-style-type: none"> • 1 x LED, bi-color, blue / green

Operational

Maximum Pixel Clock	<ul style="list-style-type: none"> • 300 MHz
Power Input	<ul style="list-style-type: none"> • 24V DC
Power Consumption	<ul style="list-style-type: none"> • 12 Watts (max.)
Operating Temperature	<ul style="list-style-type: none"> • +32 to +113 °F (0 to +45 °C)
Storage Temperature	<ul style="list-style-type: none"> • -4 to +185 °F (-20 to +85 °C)
Storage Humidity (RH)	<ul style="list-style-type: none"> • 0% to 90%, non-condensing
Operating Humidity (RH)	<ul style="list-style-type: none"> • 5% to 90%, non-condensing
MTBF	<ul style="list-style-type: none"> • 50,000 Hours

Physical

Dimensions (W x H x D) (Sender / Receiver)	<ul style="list-style-type: none"> • 4.3" x 1" x 3.2" (110mm x 26mm x 85mm)
Unit Weight (ea.)	<ul style="list-style-type: none"> • 0.4 lb (0.2 kg)

B

Bidirectional IR Control [11](#)

C

Connection Instructions [6](#)

D

DIP Switch Configuration [14](#)

E

EDID Management [15](#)

F

Features [vi](#)

H

HPD Mode [16](#)

I

Installation [6](#)

L

LED Status [10](#)

M

Mounting Instructions [20](#)

N

Network Cable Diagram [21](#)

O

Operating Notes [v](#)

P

Packing List [vii](#)

R

Receiver Unit [4](#)

S

Safety Instructions [ii](#)

Sender Unit [2](#)

Specifications [22](#)

T

Table of Contents [viii](#)

Technical Support [iv](#)

W

Warranty Information [iii](#)

Wiring Diagram [7](#)



1800 S McDowell Blvd. Petaluma CA 94954
(707) 283-5900 (800) 472-5555