

HUB Series

DIGITAL MATRIX

Digital zoner with DSP



USER MANUAL

INDEX

1. IMPORTANT REMARK	3
2. IMPORTANT SAFETY INSTRUCTIONS	3
3. IMPORTANT NOTE	5
4. INTRODUCTION	5
5. INSTALLATION AND CONNECTION.....	8
5.1. Location, mounting and ventilation	8
5.2. Mains connection and power on.....	8
5.3. Local audio input connections.....	9
5.4. Remote Audio Input Connections	11
5.5. Connections PAGER A, PAGER B and priority PAGER / DUCKER modules	12
5.6. REMOTE INPUTS 1 to 8 Connections	13
5.7. Remote ports, RJ45 interface pins.....	14
5.8. Output Audio Connections.....	15
5.9. ETHERNET and RS-232 programming and control ports	16
5.10. MUTE port.....	17
6. CONFIGURATION AND CONTROL	18
6.1. Configuration via embedded web application	18
6.2. Operation from the front panel	21
7. FUNCTION LIST	25
8. FUNCTION DIAGRAM	26
9. BLOCKS DIAGRAM.....	27
9.1. HUB1408.....	27
9.2. HUB1616.....	28
10. TECHNICAL FEATURES.....	29
10.1 HUB1418.....	29
10.2 HUB1616.....	32

1. IMPORTANT REMARK



WARNING: SHOCK HAZARD - DO NOT OPEN
AVIS: RISQUE DE CHOC ÉLECTRIQUE - NE PAS OUVRIR



The lightning flash with arrowhead symbol, within an equilateral triangle, is intended to alert the user to the presence of uninsulated “dangerous voltage” within the product’s enclosure that may be of sufficient magnitude to constitute a risk of electric shock to persons.



The exclamation point within an equilateral triangle is intended to alert the user to the presence of important operating and maintenance (servicing) instructions in the literature accompanying the appliance.

WARNING (If applicable): The terminals marked with symbol of “” may be of sufficient magnitude to constitute a risk of electric shock. The external wiring connected to the terminals requires installation by an instructed person or the use of ready-made leads or cords.

WARNING: To prevent fire or shock hazard, do not expose this equipment to rain or moisture.

WARNING: An apparatus with Class I construction shall be connected to a mains socket-outlet with a protective earthing connection.

2. IMPORTANT SAFETY INSTRUCTIONS

1. Read these instructions.
2. Keep these instructions.
3. Heed all warnings.
4. Follow all instructions.
5. Do not use this apparatus near water.
6. Clean only with dry cloth.
7. Do not block any ventilation openings. Install in accordance with the manufacturer’s instructions.
8. Do not install near any heat sources such as radiators, heat registers, stoves, or other apparatus (including amplifiers) that produce heat.

9. Do not defeat the safety purpose of the polarized or grounding type plug. A polarized plug has two blades with one wider than the other. A grounding type plug has two blades and a third grounding prong. The wide blade or the third prong are provided for your safety. If the provided plug does not fit into your outlet, consult an electrician for replacement of the obsolete outlet.
10. Protect the power cord from being walked on or pinched particularly at the plugs, convenience receptacles, and at the point where they exit from the apparatus.
11. Only use attachments/accessories specified by the manufacturer.
12. Unplug the apparatus during lightening sorts or when unused for long periods of time.
13. Refer all servicing to qualified personnel. Servicing is required when the apparatus has been damaged in any way, such as power supply cord or plug is damaged, liquid has been spilled or objects have fallen into the apparatus, the apparatus has been exposed to rain or moisture, does not operate normally, or has been dropped.
14. Disconnecting from mains: Switching off the POWER switch all the functions and light indicators of the amplifier will be stopped, but fully disconnecting the device from mains is done unplugging the power cord from the mains input socket. For this reason, it always shall remain readily operable.
15. Equipment is connected to a socket-outlet with earthing connection by means of a power cord.
16. The marking information is located at the bottom of apparatus.
17. The apparatus shall not be exposed to dripping or splashing and that no objects filled with liquids, such as vases, shall be placed on apparatus.

NOTE: This equipment has been tested and found to comply with the limits for a Class A digital device, pursuant to part 15 of the FCC Rules. These limits are designed to provide reasonable protection against harmful interference when the equipment is operated in a commercial environment. This equipment generates, uses, and can radiate radio frequency energy and, if not installed and used in accordance with the instruction manual, may cause harmful interference to radio communications. Operation of this equipment in a residential area is likely to cause harmful interference in which case the user will be required to correct the interference at his own expense.



WARNING: This product must not be discarded, under any circumstance, as unsorted urban waste. Take to the nearest electrical and electronic waste treatment centre.

NEEC AUDIO BARCELONA, S.L. accepts no liability for any damage that may be caused to people, animal or objects due to failure to comply with the warnings above.

3. IMPORTANT NOTE

Thank you for choosing our **digital zoner with DSP HUB1408 / HUB1616!**

It is **VERY IMPORTANT** to carefully read this manual and to fully understand its contents before any connection in order to maximize your use and get the best performance from this equipment.

To ensure optimal operation of this device, we strongly recommend that its maintenance be carried out by our authorized Technical Services.

The Ecler **HUB1408/ HUB1616** come with a **3-year** warranty.

4. INTRODUCTION

HUB1408/HUB1616 is a zone manager with multiple inputs and outputs, an evolution of its predecessor eMIMO1616. It has the HANGAR embedded web-server application (control from standard web browser in Windows / MacOS, etc.) for its configuration; remote control from physical wall installation panels, call (paging) stations and applications for mobile devices (Android, iOS). Includes DSP with specific functions for both inputs and outputs.

HUB Series offers multiple possibilities, being intuitive and easy to configure. From the least experienced user to the most expert, you can set up a professional audio installation in a matter of minutes (Plug & Play). It is the perfect solution for any type of sound that requires managing and controlling different zones.

Main features:

- Local stereo audio inputs: 4x HUB1616 inputs (INPUT1-4), 2x HUB1408 inputs (INPUT1-2). Compatible with line level and gain adjustment from -5 to +15 dB. 2xRCA and Euroblock connectors on rear panel.
- Local mono audio inputs: 4x HUB1616 inputs (INPUT5-8), 4x HUB1408 inputs (INPUT3-6). Microphone and line level compatible, gain adjustment from 0 to +50 dB. Euroblock connectors on rear panel. Software configurable to 2 stereo inputs.
- 8 remote balanced mono audio inputs, compatible with line level. Available on rear panel RJ45 connectors (REMOTE INPUT1-8)
- 2 local PAGER inputs (A and B), compatible with eMPAGE type call stations, receiving the signal from their microphone. RJ45 connectors on the rear panel: HUB1616: INPUT 7 and INPUT 8; HUB1408: INPUT 5 and 6.INPUT 6
- Audio output channels (zone outputs) 16x HUB1616 outputs, 8x HUB1408 outputs. Line level, balanced and independently configurable as:
 - mono outputs (1 channel per output)
 - stereo outputs (2 channels per output, natural pairs 1-2, 3-4, 5-6, etc.)

- 1 headphone audio output for output zone MONITOR function, mini-jack connector and front panel volume control
- 8 REMOTE ports for the connection of digital remote panels type eMCONTROL1, with wall format RJ45 connectors on the rear panel
- Ethernet interface with RJ45 connector, for programming and remote control of the unit by means of integrated HANGAR web application (embedded web-server) and/or TP-NET protocol for integration with third parties
- DHCP (factory setting) and static IP modes
- RS-232 interface with DB9 connector, for remote control of the unit via TP-NET protocol for integration with third parties
- MUTE port for muting one or more zone outputs by means of external potential-free contact closure
- Meter sets for displaying output signals (zones) from the front panel
- SELECT / MUTE key for each zone output on the front panel
- LCD display, CONTROL key (CTRL) and digital rotary control (encoder) for control of the unit's zone outputs from the front panel
- DATA (connection from external client devices) and ON indicators on the front panel
- Processing available in inputs:
 - 3-tone equalization adjustment via BASS-MID-TREBLE controls
 - Volume adjustment and MUTE control
 - Phase inversion
 - Stereo: Allows balanced audio inputs to be configured in stereo pairs. Available on local inputs INPUT5-8 on HUB1616, INPUT3-6 on HUB1408
 - Frequency shifter available for the microphone inputs: local inputs INPUT5-8 on HUB1616, INPUT3-6 on HUB1408
 - Noise gate: available on local inputs INPUT5-8 on HUB1616, INPUT3-6 on HUB1408.
 - High-pass filter: with adjustable frequency available on local inputs INPUT5-8 on HUB1616, INPUT3-6 on HUB1408
 - Audio over audio priority function, with 4 levels and volume control independent from the 4 (from -40dB to +6dB): inputs 5 to 8 MIC/LINE on HUB1616, inputs 3 to 6 on HUB1408, can attenuate (or totally mute) the sound content present (program audio) in certain target areas, enabling the broadcasting of emergency messages, warnings, etc. Each of the above inputs can exercise this function with priority 1 (higher) or 4 (lower). Priority function activation modes can be:
 - DUCKER, by audio signal detection: when a valid signal is received and as long as it persists in the input in question. Available on local inputs 5 to 8 on HUB1616, local inputs 3 to 6 on HUB1408

- PAGER: by selection of destination zones, pressing the PAGE key and voice announcing in real time from eMPAGE type call stations. Chime tone available to be triggered prior to message voicing by activating the PAGE function. Available on local inputs 7 and 8 on HUB1616, local inputs 5 and 6 on HUB1408 (PAGER A and PAGER B, respectively)
- Processing available in outputs:
 - Mono mode (outputs managed individually) or stereo mode (areas managed in natural pairs: 1-2, 3-4, etc.). Automatic management of mono or stereo audio sources routed to mono or stereo outputs
 - Program source selection (local or remote audio inputs)
 - 3-tone equalization adjustment via BASS-MID-TREBLE controls
 - Volume adjustment and MUTE control
 - Limitation of the range of available output volume (minimum and maximum levels) to the end user, from any control method (eMCONTROL1 panels, pilot application clients, etc.)
 - Phase inversion
 - Enablement for silencing via rear panel MUTE port (via external contact closure)
 - Delay setting: available for zone outputs 1 to 8 on HUB1616, all zone outputs on HUB1408
 - Crossover filter: Filter-low-pass (LPF) or filter-high-pass (HPF) setting with cut-off frequency adjustment Available for zone outputs 1 to 8 on HUB1616, all zone outputs on HUB1408
 - 8-band graphic equalizer.
 - 8-band graphic equalizer. Available on all zone outputs on both models
 - Compressor/limiter available on all zone outputs on both models
- General Volume: general volume control, of all outputs or a selection of them
- Programming and control as an Administrator (**admin**) user from the **HANGAR embedded web application**, using a computer, tablet or mobile device and a standard web browser (no dedicated software installation)
- Remote control of end users by:
 - Front panel control, with configurable access restrictions
 - eMCONTROL1-type physical wall panels
 - eMPAGE-type paging stations
 - **Ecler pilot** application, available for iOS and Android client devices
 - Standard web browsers, from computers, tablets, etc.

- Predefined setups: default settings (templates) accessible from the web server and from the Ecler pilot app

Note: from the unit's embedded web application, HANGAR, the **admin** user configures the restrictions of the controls and settings available from the front panel and from the physical wall panels (eMCONTROL1) and call stations (eMPAGE) for the end user, as well as the user accounts and graphic control panels and settings that the end customers of the **Ecler pilot** and web applications will be able to handle.

5. INSTALLATION AND CONNECTION

5.1. Location, mounting and ventilation

HUB1616/ HUB1408 has been specially designed to be placed in 19" rack structure, occupying two units.

It is very important that, as a heat generating element, the unit is not completely enclosed or exposed to extreme temperatures. Fresh air should be allowed to pass through the ventilation holes in the chassis, leaving at least one free rack unit between each piece of equipment and those installed above and below it in the rack frame.

If the installation consists of several units in the same rack or is carried out inside cabinets closed by means of doors, it is highly recommendable to equip them with forced upward ventilation, installing fans at their lower and upper ends. This upward flow of ventilation will favor the dissipation of the heat generated in its interior.

5.2. Mains connection and power on

HUB1616/ HUB1408 operates on alternating voltages from 90 to 264V and 47 to 63Hz. This device is equipped with an oversized power supply capable of adapting without any type of adjustment to the mains voltage of any country in the world.

On the rear panel, next to the IEC power connector, there is an on/off switch for the unit. On the front panel there is a LED **ON** indicator that illuminates when the unit is in operation.

Do not allow the network cable to run parallel to the shielded cables carrying the audio signal, as this may cause humming.

5.3. Local audio input connections

HUB1616 has 8 local audio inputs on its rear panel, HUB1408 has 6 local inputs, with the following types of connections available:

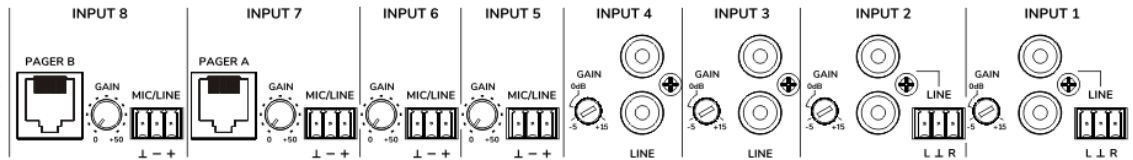

Figure 1: HUB1616 local inputs

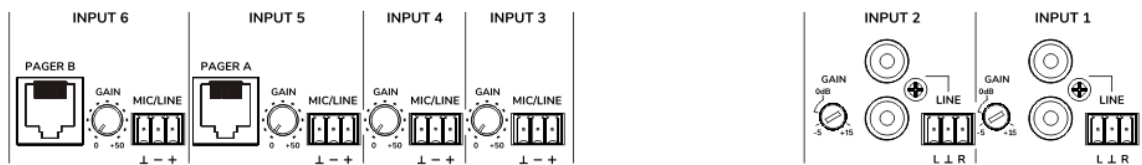

Figure 2: HUB1408 local inputs

- HUB1616: INPUT1 to INPUT4; HUB1408: INPUT1 and INPUT2: **unbalanced stereo line** signals with double connector format (RCA and Euroblock). Use one or the other connector, depending on the type of wiring available between your sound source and the HUB unit:
 - Dual RCA Connector: Connect your stereo sound source (CD players, Smartphones, radio tuners, streaming players, etc.) directly using a cable that delivers the left (L) and right (R) channels to the unit's white and red RCA connectors, respectively.
 - Euroblock connector, 3-pin: connect your stereo sound source this way:
 - Left channel > Terminal L
 - Right channel > Terminal R
 - Ground > Terminal ⊥
- HUB1616: INPUT5 to INPUT8; HUB1408: INPUT3 to INPUT6: Microphone or line signals, **mono and balanced**, with 3-pin Euroblock connector:
 - Live or direct signal > Terminal +
 - Cold or inverted signal > Terminal -
 - Ground > Terminal ⊥

Note: If your sound source is stereo, and you want to connect it to one of the local inputs IN5 to IN8 of the HUB1616 unit (local inputs IN3 to IN6 in HUB1408), mono and balanced, you can do it by means of the following stereo to mono conversion, only using a pair of external resistors:

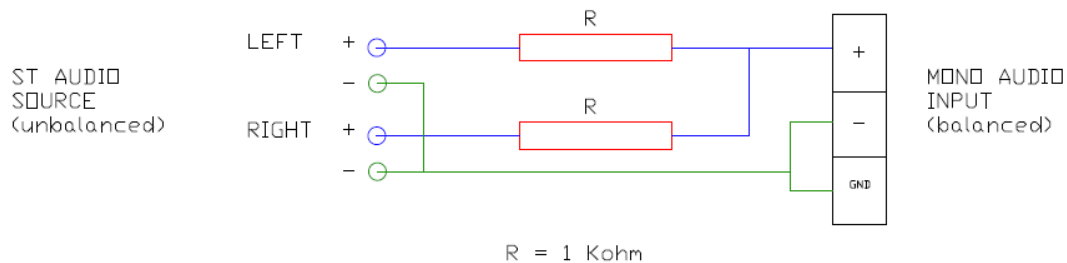

Figure 3: stereo to mono conversion

On the rear panel of the unit there is a PHANTOM ON/OFF switch, which provides phantom power to inputs 5 to 8 on the HUB1616, inputs 3 to 6 on the HUB1408, for use with microphones that require it, usually condenser microphones.

- Additionally, there are 2 connection ports called PAGER A and PAGER B, with audio inputs INPUT7 and INPUT8 (respectively) on HUB1616, inputs INPUT5 and INPUT6 on HUB1408, duplicated for use with PAGER priority modules). These ports receive audio signals from eMPAGE type call stations. A standard CAT5 cable (uncrossed) or higher, with RJ45 connector on both ends, connects a calling station point to one of the unit's A or B ports, running through it the station's remote DC power, control data and balanced audio picked up by the station's microphone. The maximum number of stations allowed is 2: one connected to port PAGER A and/or the other to port PAGER B.

Once the physical connection of the different audio inputs has been made, it will be necessary to act on the GAIN controls of each one of them to obtain an optimum signal intensity and maximum signal/noise ratio, so that they can be used correctly as sound sources in the installation. Try to maximize the volume controls of the audio players before adjusting the gain in the HUB unit. Use the level indicators on the front of the unit (physical VU meters), as well as the virtual level indicators (on-screen VU meters) of the HANGAR web application for the correct gain adjustment, trying to work normally with signal peaks in the area close to 0 dB (orange area in the virtual VU meters) and very exceptionally above it ("red", saturation or clip area).

5.4. Remote Audio Input Connections

The HUB1616 / HUB1408 has 8 control ports (REMOTE INPUTS) with RJ45 connector, for the connection of eMCONTROL1 type remote control panels. Each of these ports, besides providing DC power and establishing the digital communication bus with the remote panels, has a mono audio input, balanced and with line level, considered a **remote input** of the HUB unit. In this way, it is possible to expand the number of audio inputs of the equipment with these 8 remote inputs, in addition to the local inputs available through audio connectors on the rear panel of the matrix.

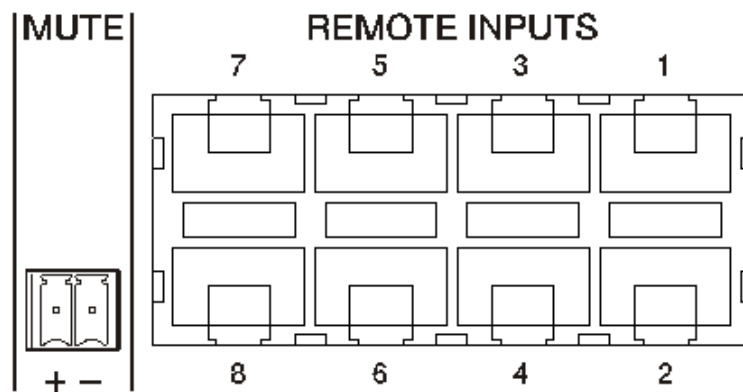

Figure 4: remote inputs (wall control panels)

Connecting a balanced mono audio signal to a REMOTE port of a HUB device is done as follows:

- Live or direct signal > Terminal 8 of the RJ45 connector
- Cold or inverted signal > Terminal 7 of RJ45 connector
- Ground > Terminal 6 of RJ45 connector

If an eMCONTROL1 type remote panel is used to control an area of the installation, the eMCONTROL1 panel itself has an internal connector to receive the audio signal from an adjacent and complementary panel, such as the WPaMIX-T in the pair of the example below. This type of configuration is ideal to have zone control and remote audio from the zone itself: a single standard CAT5 cable, connected between the eMCONTROL1 panel and a REMOTE port of the HUB unit, is used to carry out the exchange of DC power, digital control data and remote audio signal, physically entered in the eMCONTROL1 complementary panel, to the HUB unit.

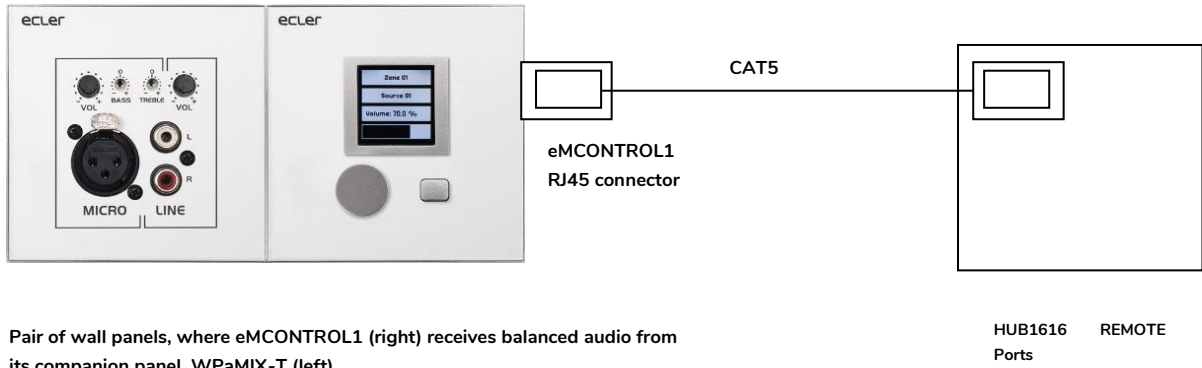

Figure 5: WPaMIX-T and eMCONTROL1 mounting

5.5. Connections PAGER A, PAGER B and priority PAGER / DUCKER modules

In the local input section of the rear panel there are 2 connection ports called PAGER A and PAGER B, whose audio inputs correspond internally to the INPUT 7 and INPUT 8 inputs (respectively) on the HUB1616, INPUT5 and INPUT6 on the HUB1408.

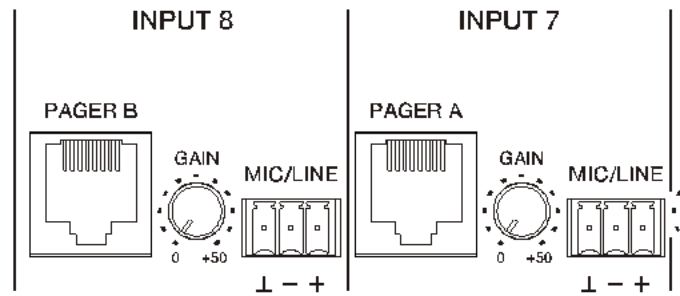

Figure 6: PAGER/DUCKER ports on HUB1616

The PAGER ports are used for point-to-point connection to eMPAGE-type call stations, through which it is possible to carry out real-time voice call (paging) actions to exit areas of the installation, using a priority module of the HUB unit that attenuates or completely silences the sound content of the program existing in these areas at the time of the action.

A standard CAT5 cable (uncrossed) or higher, with RJ45 connector on both ends, connects a calling station point to one of the unit's A or B ports, running through it the station's remote DC power, control data and balanced audio picked up by the station's microphone.

The maximum number of stations allowed is 2: one connected to the PAGER A port and/or the other to the PAGER B port, each using a PAGER priority module in the HUB unit.

Note: The following connections cannot be made simultaneously, as they are **exclusive**:

- a call station to the PAGER A port + an audio signal to the Euroblock connector of the INPUT7 input on the HUB1616, INPUT5 on the HUB1408
- a call station to the PAGER B port + an audio signal to the Euroblock connector of the INPUT8 on HUB1616, INPUT6 on HUB1408

The total number of PAGER (with call station) or DUCKER (without call station) priority modules in a HUB device is 4, assignable to local inputs 5 to 8 in HUB1616, local inputs 3 to 6 in HUB1408. These 4 modules can be activated or not, and each of them can use one of the 4 priority levels available, so that the signals with higher priority will attenuate the program signal selected in the destination zones and also the signals with lower priority sent to those zones, if they exist, when the module with maximum priority is activated.

Refer to the [HANGAR web application manual](#) for programming the PAGER / DUCKER priority modules.

5.6. REMOTE INPUTS 1 to 8 Connections

On the rear panel of a HUB device there are 8 control ports, REMOTE INPUTS 1 to 8, enabled for the connection of eMCONTROL1 type zone control wall panels. Each port has an RJ45 type connector, and each eMCONTROL1 type panel also has an RJ45 connector, so that the physical connection between a remote panel and a REMOTE port of the HUB unit is made, point to point, by means of a standard CAT5 or higher type cable (not crossed).

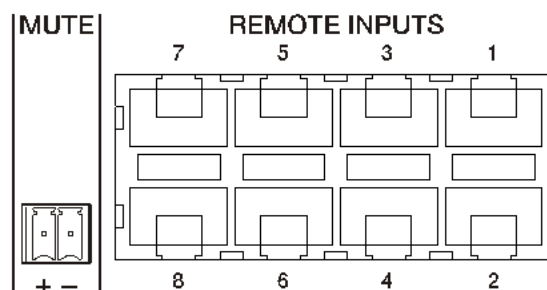

Figure 7: remote audio inputs

This physical connection provides DC power to the remote panel from the HUB unit and establishes the digital communication bus between the two units. It also implements balanced mono audio reception from a potential remote sound source (connected on the side of the control panel) in the HUB unit.

The control wall panels are configured by the user Administrator through the HANGAR web application (see HANGAR [web application manual](#)), so it is possible to disable them completely or to enable them to act as user control for a zone of the installation, including all or some of the following functions:

- Sound source selection (program audio), from a customized list for each panel that includes some local sources and/or the remote source itself
- Volume adjustment (with maximum and minimum operating range) and mute control
- Equalization adjustment, with 3-tone control (BASS-MID-TREBLE)

Alternatively, these inputs can only receive a balanced mono audio signal via the RJ-45 connector, respecting the corresponding pin assignment (see section 3.4):

- Ground > Pin 6 of the RJ45 connector
- Cold or inverted signal > Pin 7 of RJ45 connector
- Live or direct signal > Pin 8 of RJ45 connector

5.7. Remote ports, RJ45 interface pins

- **Pins 1 & 2:** unused
- **Pin 3:** +12 VDC power supply
- **Pins 4 & 5:** data bus
- **Pin 6:** ground
- **Pin 7:** audio cold or inverted signal
- **Pin 8:** audio hot or direct signal

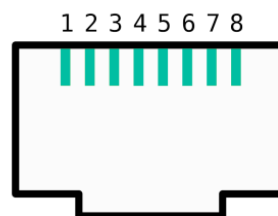

5.8. Output Audio Connections

HUB1616 has 16 audio output channels (zone outputs), 8 in HUB1408, with line level, balanced and independently configurable as:

- mono outputs (1 channel per output)
- stereo outputs (2 channels per output, natural pairs 1-2, 3-4, 5-6, etc.)

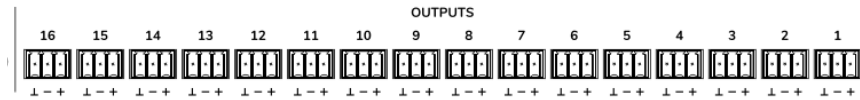

Figure 8: HUB1616 zone outputs

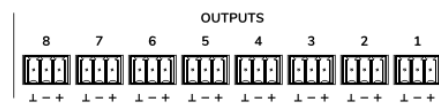

Figure 9: HUB1408 zone outputs

Each output has a 3-pin Euroblock connector, with the following layout:

- Live or direct signal > Terminal +
- Cold or inverted signal > Terminal -
- Ground > Terminal ⊥

If an output channel is connected to an amplifier or audio device with a **balanced** input, the + and - ⊥ terminals must be connected point by point and between the two devices. When connecting an output channel to an amplifier or device with an **unbalanced** audio input, leave the - terminal unconnected.

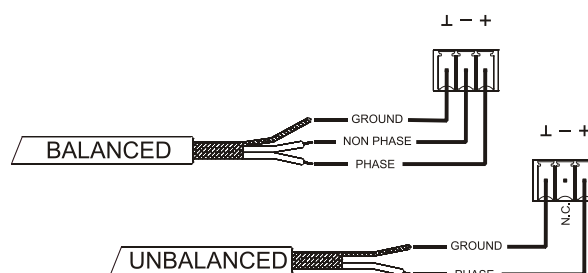

Figure 10: balanced audio output connection

MONITOR OUTPUT (marked with headphone symbol): 3.5mm stereo mini-jack connector with a rotary level control for headphone listening. It is especially useful for listening to the unit's output signals without disturbing its normal operation. The selection of the signal to listen to is made through the front panel, simply by pressing the “select” button of the zone you want to monitor. The headphone volume control is located after the zone volume control and after the general volume control (GENERAL VOLUME), so you should consider the zone volume and the general volume or, if the zone or general volume control is set to MUTE.

5.9. ETHERNET and RS-232 programming and control ports

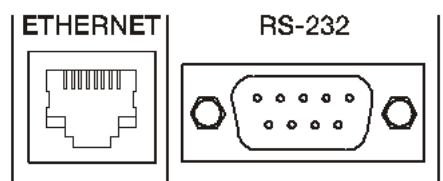

Figure 11: control ports

The RJ45-type ETHERNET connector on the rear panel allows the equipment to be connected to an Ethernet network, or directly to a computer or other device with an Ethernet interface, point-to-point. This connection enables, within a local network, the following:

- Global programming and management of the HUB unit using the HANGAR embedded web application and a standard web browser running on a computer, tablet, etc.
- Connection of client devices for end-user management of areas of the installation through the **Ecler pilot** application, compatible with Android and iOS, or through standard web browsers running on computers, tablets, etc.
- Connection of third-party devices for integration in control systems (Crestron®, Extron®, AMX®, Vity®, Medialon®, etc., registered trademarks by their manufacturers), using the TP-NET protocol embedded in the HUB devices. Refer to the [TP-NET protocol manual](#) for more information.

The RS-232 type DB9 connector on the rear panel allows the connection of the point-to-point equipment to a computer or other control device. This connection is used only for serial port integration with third party equipment and control systems (Crestron®, Extron®, AMX®, Vity®, Medialon®, etc., registered trademarks of their manufacturers) using the TP-NET protocol embedded in HUB devices. Refer to the [TP-NET protocol manual](#) for more information.

The parameters required for a correct serial connection are as follows:

- Baud rate: 115200 (fixed, no auto negotiation)
- Data bits: 8
- Parity: None
- Stop bits: 1
- Flow control: None

5.10. MUTE port

The HUB1616 / HUB1408 has on its rear panel a control input, or MUTE port (Normally Open = MUTE OFF / Closed = MUTE ON), which allows the activation / deactivation of the mute of audio outputs (zones) of the unit by means of a push button, relay or external potential free contact closure.

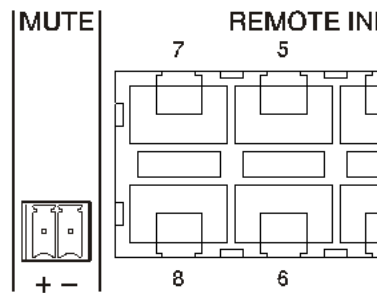

Figure 12: MUTE port

The assignment of outputs affected by the MUTE port is configured from the HANGAR web application. Refer to the [HANGAR web application](#) manual for more information.

6. CONFIGURATION AND CONTROL

6.1. Configuration via embedded web application

Once the physical connections have been made, the HUB unit must be configured using the integrated web application: HANGAR. It has to be configured from a computer, Tablet or similar where a standard web browser is running, pointing to the unit's IP address, which can be modified. This task is reserved exclusively for the installer or system administrator, who must identify himself with his “**admin**” user credentials:

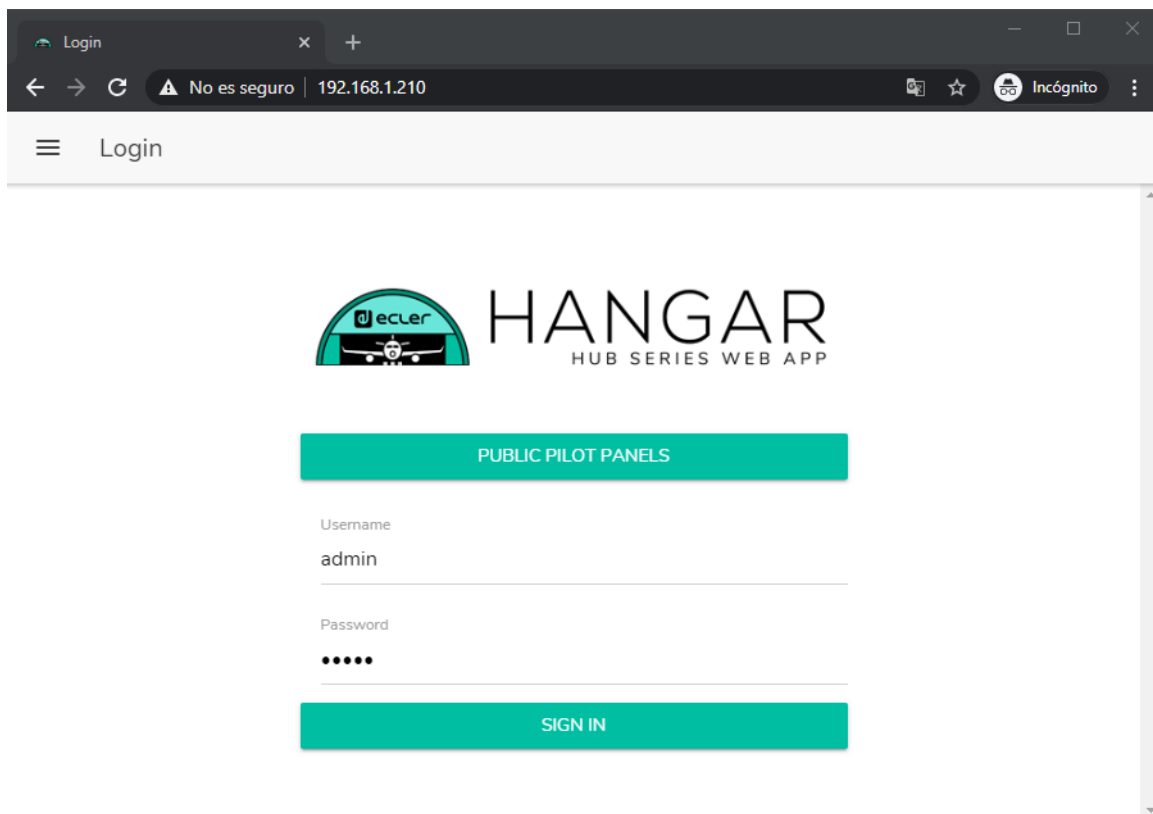

Figure 13: HANGAR, web application for configuration and control of HUB devices

Refer to the [HANGAR web application](#) manual for complete information about configuring your computer using the built-in web server.

By default, the network configuration is in DHCP mode (dynamic IP address assignment). Connection to a router/switch with DHCP server is required. To query the IP assigned to the device, press and hold the CTRL and rotary encoder keys simultaneously for 3 seconds.

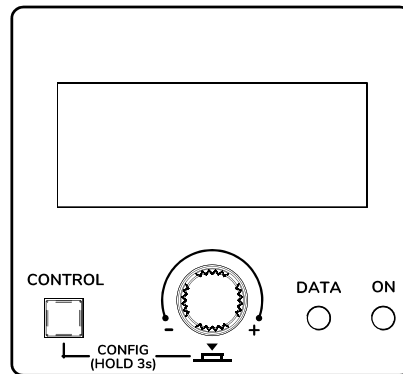

Figure 14: front panel LCD display and control keys

Note: HUB devices use the mDNS service to access them through a web browser on the same local network (LAN). To do this, enter in the search bar of your browser: device_name.local. By default, “hub1616.local” in HUB1616, “hub1408.local” in HUB1408.

The configuration screen (CONFIG) shows the following information:

- Firmware version running on the unit
- NAME: name of the HUB unit
- Network connection parameters: IP address, subnet mask and network gateway
- Auto/Manual: IP assignment mode. AUTO: is in DHCP mode, the IP address assignment is automatic. MANUAL: allows the configuration of manual network parameters. Default:
 - IP: 192.168.0.100
 - MASK: 255.255.0.0
 - GW: 192.168.0.1
- Admin: number of admin users connected to the unit (0 or 1)
- Users: number of client users, via Ecler pilot application or web browsers (0 to 20)

The main parameters, settings and functions accessible in a HUB device from its web application are:

- General configuration: unit name, network parameters, project saving and retrieval (global device settings except network parameters), boot mode, firmware update, restore to default parameters/factory settings, connection status and default settings (*Predefined setups*).
- User accounts management, which will allow the access of external clients (final users) through the Ecler pilot application or web browsers: names, passwords and enabled/disabled status Public profile edition (access without credentials) and permission to load default settings from this profile. Edition of the administrator access password.
- Front panel parameters:
 - LCD display settings: brightness, contrast, sleep mode
 - global access/locking (of all front controls)
 - access/blocking of certain controls, and certain exit areas, on an individual basis. It is possible to allow access to the settings of some zones and to block those of others, and even to decide which parameters are accessible for each one of them: volume adjustment & MUTE and/or sound source selection and/or equalisation by means of 3-tone control (BASS-MID-TREBLE)
 - Selection of last zone or general volume. The front panel display will show the selected option after a few seconds of inactivity on the front panel.
- Local and remote audio input parameters: names, stereo mode, frequency shifter, polarity, volume, MUTE, equalization by 3-tone control (BASS-MID-TREBLE), noise gate and high-pass filter.
- Audio output parameters (zones): names, mono / stereo mode, polarity, sound source selection, volume, range of volume accessible to end users (minimum and maximum levels), MUTE, equalisation by 3-tone control (BASS-MID-TREBLE), delay adjustment, crossover filter (LPF / HPF), graphic equalisation, compressor/limiter and MUTE port activation assignment (external contact closure).
- General volume settings: volume, MUTE, range of volume accessible to end users (minimum and maximum levels) and selection of audio outputs (zones) that will be affected by the overall volume
- Configuration of the 4 PAGER / DUCKER priority modules (with eMPAGE type call stations / activated by audio level detection on the input in question, respectively)

- Configuration of the eMCONTROL1-type physical control panels connected to the HUB unit: connection status, enabled/disabled status, zone under its control, enabled functions (volume adjustment & MUTE and/or sound source selection and/or equalisation via 3-tone control (BASS-MID-TREBLE)), etc.
- Creation, edition and configuration of the pilot panels, accessible from external devices through the Ecler pilot application or web browsers: public or private type panel (accessible only by certain users), enabled/disabled status, area under its control, enabled functions (volume & MUTE adjustment and/or sound source selection and/or equalization through 3-tone control (BASS-MID-TREBLE)), graphic aspect (slider or rotary control types, control colors, texts and background), etc.

6.2. Operation from the front panel

Using the physical controls on the front panel of a HUB device, adjustments can be made to the different output zones of the unit. The settings available for the different zones will be those enabled by the **admin** user from the HANGAR web application, and can range from total blocking of the front panel to total freedom of control of all zones (volume adjustment, source selection and equalisation settings), to total or partial blocking of some of them.

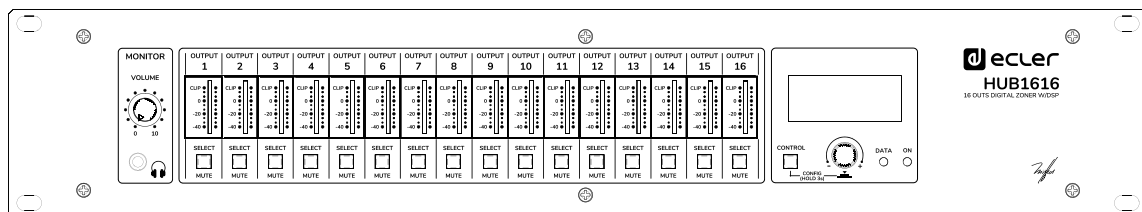

Figure 15: HUB1616 front panel

Pressing a SELECT key corresponding to one of the unit's outputs takes control of the unit using the CTRL key, the digital rotary control (hereinafter **encoder**) and the LCD display on the right-hand section of the front panel. The LED on the SELECT key will also blink at a fixed rate (long time off, short time on), indicating that the output has been selected for control. After a few seconds without acting on the front controls, i.e. without making any adjustments, this key will stop flashing. If the *General Volume* option has been selected as the default zone selection, the display will show the controls for this after a few seconds of inactivity. The HUB unit has this option enabled in the factory settings.

Example by pressing the SELECT key on output 1 or 2 (same effect in this case, as they are configured as a stereo pair):



Example by pressing the SELECT key on output 3:



In the images above you can see:

- 2 level indicators or voumeters (vertical bars): the one on the left of the screen indicates the level of the selected sound source for the selected zone (*pre-fader*), and the one on the right indicates the output signal level of this zone (*post-fader*)
- First line of text: output number (zone) selected
- Second line of text: name (label) of the selected area
- SRC: selected sound source
- VOL: adjusted output volume

The flashing box over SRC or VOL, plus the line of text on light background and dark text, indicates which function is currently **in focus**, or ready for adjustment. The image below is of the VOL control, which allows the output volume to be adjusted by the encoder, and within the predefined range (by the user **admin**) for the selected output:



In this screen, a long press (>3 seconds) on the encoder, or a long press of a SELECT key activates / deactivates the MUTE function of the zone in question:



Note: about the muted outputs (active MUTE function):

- A muted output, and not selected for adjustment, will have its SELECT/MUTE button permanently lit (not flashing)
- An output that is muted and at the same time selected for setting will have its SELECT/MUTE key flashing at a fixed rate, but inverse to the rate that has an unsilenced output selected for setting

Pressing the CTRL key briefly switches the focus to the other available function, in this case the SRC function, or sound source selection:



The encoder then rotates to select one of the available sound sources, confirming its selection by pressing the encoder:



A long press on the CTRL key allows you to go to the zone equalization screen:



Here, the selected tone control is indicated by the flashing box over the text BASS, MID or TREBLE, and is adjusted by turning the encoder:



Short presses of the CTRL key allow another EQ control to be focused:



A new long press of the CTRL key, or a 10-second timeout, returns the display to its previous state, showing the main data of the zone under control:



All the controls described above for a given zone (VOL, SRC, BASS, MID and TREBLE) will be displayed and available for adjustment only if the **admin** user has enabled the front panel to do so, and a zone may be completely or partially locked out for control from the front panel.

When a particular function of a zone is disabled for adjustment from the front panel, attempting to do so will result in the following message being displayed on the LCD:



When the front panel is completely locked (disabled) for use, pressing any key will result in the following message on the LCD display:



7. FUNCTION LIST

1. Headphone volume control
2. Headphones output: 6.3Mm stereo jack
3. Vumeters LED (CH1 – CH16)
4. Key SELECT / MUTE (CH1 – CH16)
5. Control key, CTRL
6. Digital turning control (encoder)
7. Data traffic indicator LED, DATA
8. Start-up indicator LED, ON
9. LCD screen
10. Start-up switch
11. Fuse holder
12. Network socket base
13. External mute terminal, MUTE
14. Remote control/audio ports (connection with eMCONTROL1)
15. PHANTOM switch
16. PAGER port for connection to eMPAGE1 (IN7 - IN8)
17. Input Gain Adjustment, GAIN (IN7 - IN8)
18. Input terminal (Euroblock) micro and line, MIC/LINE (IN7 - IN8)
19. RJ-45 connector, ETHERNET
20. RS-232 connector RS-232 Connector
21. Input Gain Adjustment, GAIN (IN5 - IN6)
22. Input terminal (Euroblock) micro and line, MIC/LINE (IN5 - IN6)
23. Input Gain Adjustment, GAIN (IN3 - IN4)
24. Input terminal (RCA) line, LINE (IN5 - IN6)
25. Input Gain Adjustment, GAIN (IN1 - IN2)
26. Input terminal (RCA) line, LINE (IN1 - IN2)
27. Input terminal (Euroblock) line, LINE (IN1 - IN2)
28. Output terminals (Euroblock), OUTPUTS

8. FUNCTION DIAGRAM

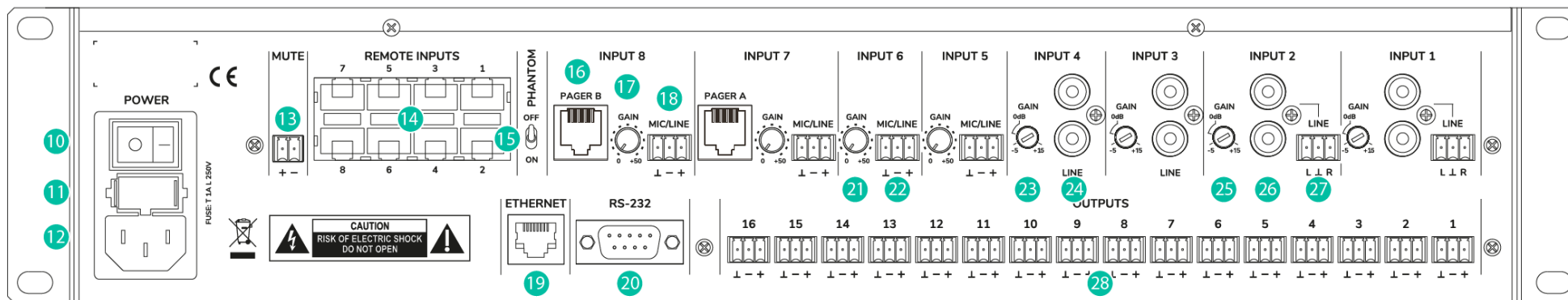
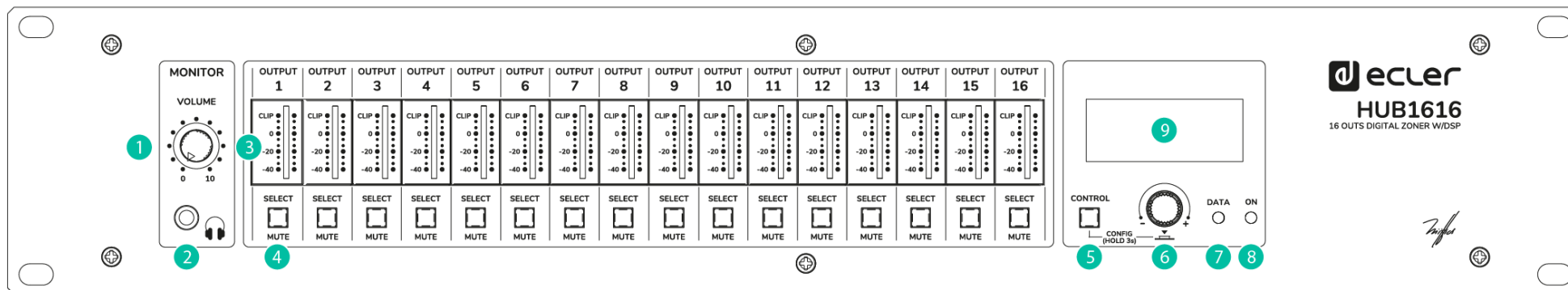

9. BLOCKS DIAGRAM

9.1. HUB1408

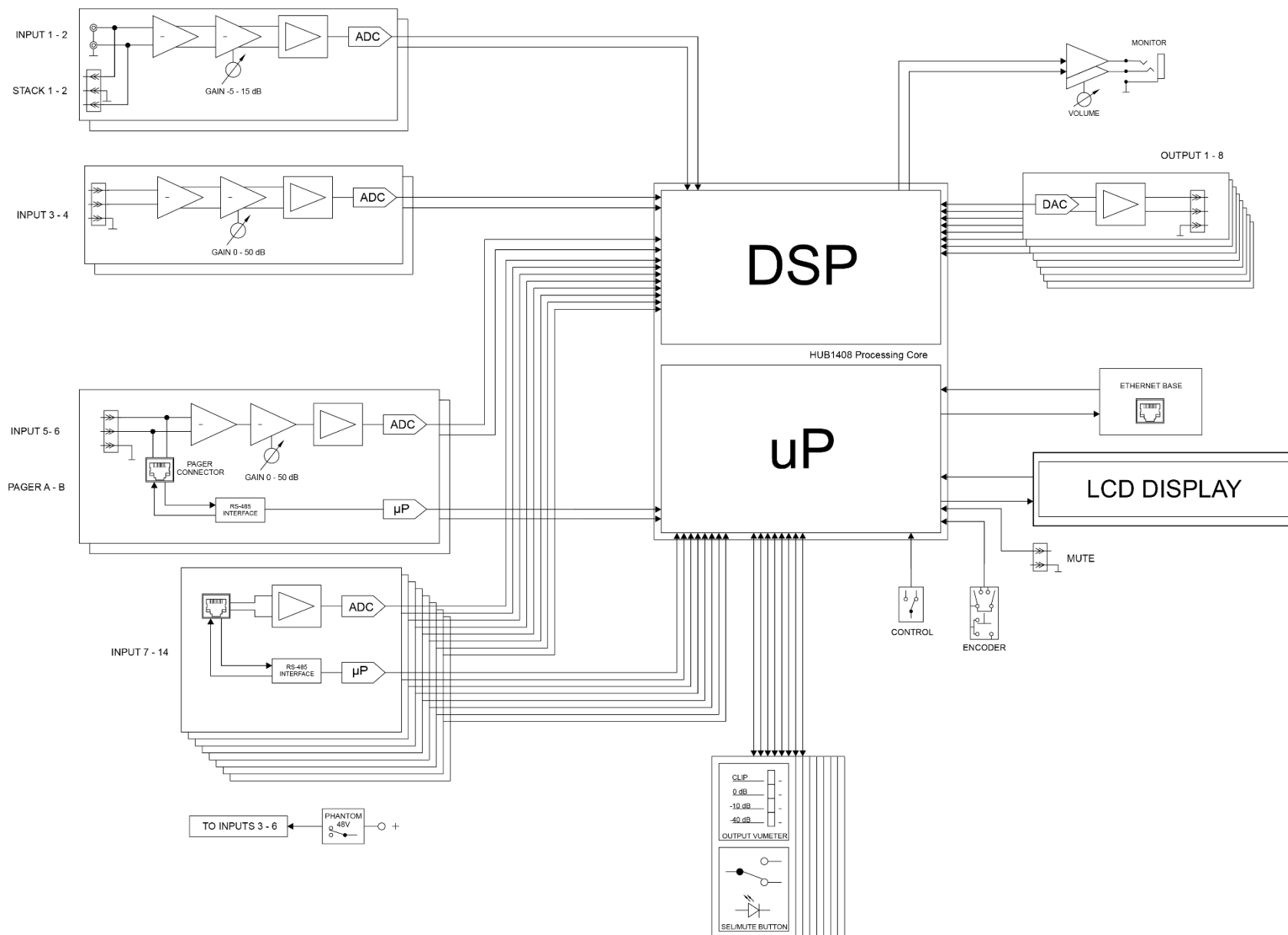

9.2. HUB1616

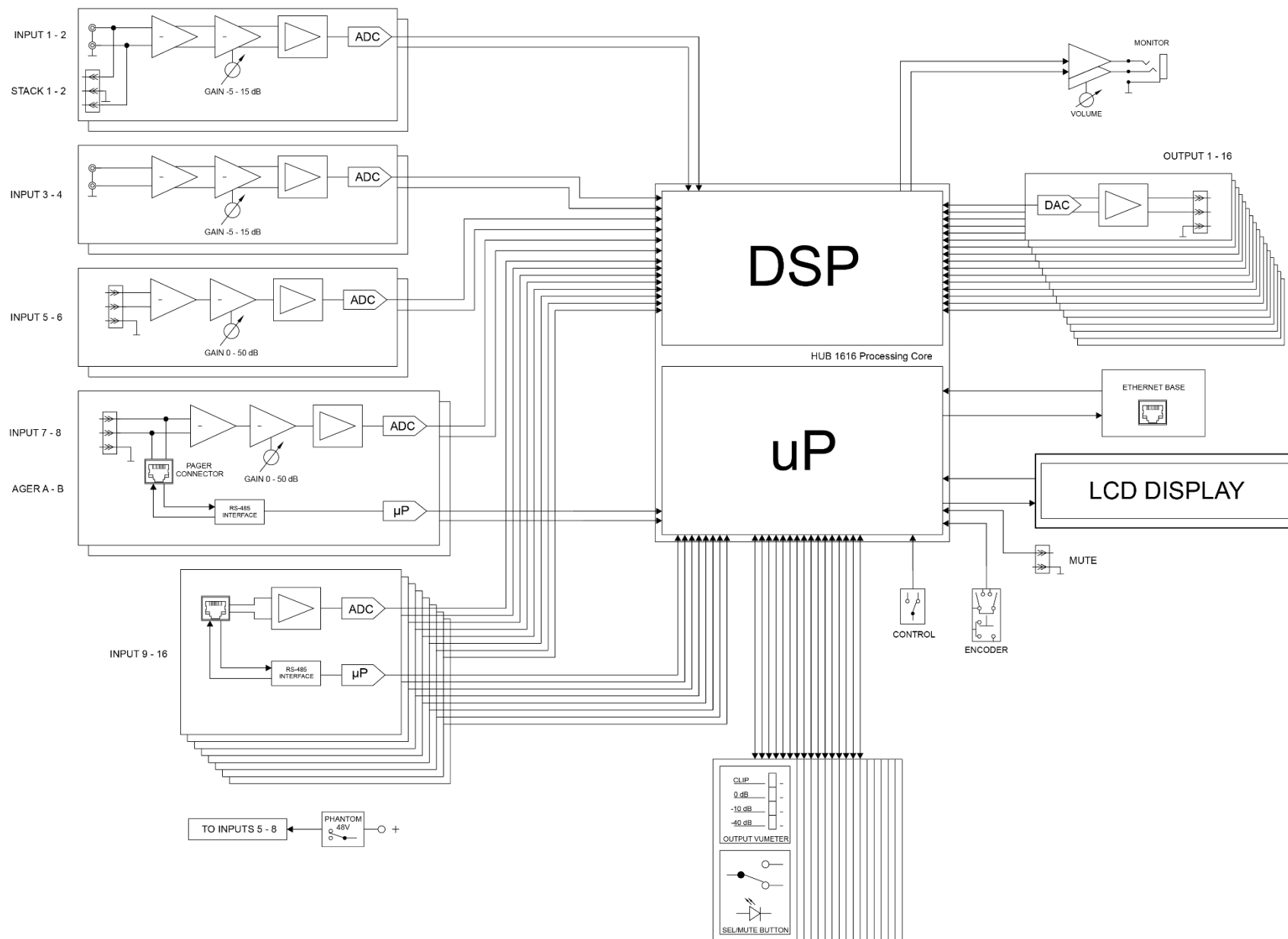

10. TECHNICAL FEATURES

10.1 HUB1418

DIGITAL	
DSP	
CPU	Floating point 32/64bit
Sampling rate	48 kHz
Latency	<1.5 ms.
Converters	
Resolution	24 bit, AKM
Dynamic range	AD:111dB, DA: 115dB
ANALOGUE	
Input 1, 2 (Line)	
Sensitivity	+5 / -15dBV External potentiometer adjustment
Impedance	>13k
Input headroom	12dBV
Connector	RCA female with Euroblock stack
Type	Unbalanced
Input 3, 4, 5 ,6 (Mic/Line)	
Sensitivity	+0 / -50dBV External potentiometer adjustment
Impedance	>24k electronically balanced
Input headroom	12dBV
Connector	Euroblock (Symmetrical)
Type	Balanced
Pagers	Input 5 and 6 (by RJ45 connector)
Phantom	+48VDC (rear panel switch)
CMRR	>60dB (20Hz - 20kHz)
Input 7 to 14 (Remote Input)	
Sensitivity	0dBV without adjustment
Impedance	>24k electronically balanced
Input headroom	12dBV
Connector	RJ45 Connector
Type	Balanced
CMRR	>60dB (20Hz - 20kHz)
Outputs 1 to 8 (Line)	
Max output level	12dBV
Connector	Euroblock 3-pin
Type	Balanced
Headphones output	
Selectable output	From Out1 to Out8
Power	>200mW – 200Ω
Connector	Mini-Jack 3,5mm
General	
External mute	Normally open. Assignable to any output zone
Frequency response	<10Hz ~ 20kHz (+0dB / -0.5dB)
Output noise floor (FFT)	>110dB (from 20Hz to 20kHz)
THD + Noise)	< 0.005% (1kHz, 1Vrms)
Crosstalk	>90dB, 20Hz - 20kHz

CMRR	>60 dB Typical
Flatness	Better than ± 0.1 dB

PROCESSING	
Input level (x14)	
Volume	From Off to 0 dB
Mute	On-Off
Metering	Vumeter post fader
Stereo	On-Off (Inputs 3 to 6)
Polarity	On-Off
High pass filter	50Hz to 150Hz (Inputs 3 to 6)
Frequency shifter	On-Off; 5Hz (Inputs 3 to 6)
Noise gate (x4)	
Inputs	Input 3 to 6, Bypass ON - OFF
Threshold	From -80dBV to +12dBV
Depth	From 0 dB to 80 dB
Attack	From 0.1ms to 500ms
Hold	From 10ms to 3000ms
Release	From 10ms to 1000ms
Input EQ (x14)	
Type	Baxandall 3-way EQ
Gain	-10dB ~ +10dB in 0.1dB steps
Frequency	Low 200Hz Mid 1kHz High 6.3kHz
Output level (x8)	
Volume	From Off to 0 dB
Mute	On-Off
Metering	Vumeter post fader
Stereo	On-Off
Polarity	On-Off
Output EQ (x8)	
Type	Baxandall 3-way EQ
Gain	-10dB ~ +10dB in 0.1dB steps
Frequency	Low 200Hz Mid 1kHz High 6.3kHz
Output graphic EQ (x8)	
Type	8-Band Graphic EQ
Gain	-10dB ~ +10dB in 0.1dB steps
Frequency	63Hz, 125Hz, 250Hz, 500Hz, 1kHz, 2kHz, 4kHz, 8kHz
Output compressor (x8)	
Bypass	On-Off
Mode	Compressor / Limiter
Threshold	-36 dB to +12 dB
Ratio	1 to 100
Knee	Soft / Hard
Attack	0.1ms to 500ms
Release	10ms to 1000ms
Make-up gain	0 dB to 10 dB
Output delay (x8)	
Outputs	1 to 8
Bypass	On-Off
Delay	0 to 300ms
Unit	ms, meters, feet

Output crossover (x8)	
Outputs	1 to 8
Bypass	On-Off
Mode	High Pass Filter / Low Pass Filter
Frequency	20Hz to 20kHz
General volume	
Volume	From Off to 0dB
Selectable outputs	Out 1 – Out 8
Ducker	
Input	IN3 to IN6. In 5 and 6 selectable: DUCKER or PAGER
Outputs	Selectable: 1-8 zones
Priority	Four levels (1max-4min)
Priority volume	-40 dB to +6 dB
Threshold	-80dB to +12dB
Depth	0dB to 80 dB
Attack	5ms to 2000ms
Release	50ms to 3000ms
Hold	10ms to 3000ms
Pager	
Input	IN5 and IN6 selectable: DUCKER or PAGER
Outputs	Selectable: 1-16 zones
Functions	Two function buttons (F1, F2)
Priority	Four levels (1max-4min)
Priority volume	-40 dB to +6 dB
Chime volume	-12dB to +0dB
Chime melody	None, Melody 1, Melody 2
Depth	0dB to 80 dB
Attack	5ms to 2000ms
Release	50ms to 3000ms
Pilot panels	
General	On-Off, Public, Label, Users and Zone
Volume control	On-Off, Label and Style
Source selection	On-Off, Label and Allowed sources
Equalizer	On-Off, Label, and Style
Color	Controls, Text and Background
OTHERS	
Mechanical	
Dimensions	482,6 x 88,0 x 210,0mm / 19.0" x 3.5" x 8,3" (WxHxD)
Weight	3,60kg / 7.93 lb.
Power supply	
Mains	90-240 VAC, 50-60Hz
Power consumption	20W
Connectivity	
Management Connectivity	Ethernet Base-Tx 10/100Mb Auto X-Over CAT5 up to 100m
Remote bus	RS485
Aux. Power Supply for Remotes	+12VDC, 0,6A max. (short circuit protected)
Programming and control	Hangar (embedded web application), Ecler pilot (Andorid/iOS application), TPNET (UDP/RS232)

10.2 HUB1616

DIGITAL	
DSP	
CPU	Floating point 32/64bit
Sampling rate	48 kHz
Latency	<1.5 ms.
Converters	
Resolution	24 bit, AKM
Dynamic range	AD:111dB, DA: 115dB
ANALOGUE	
Input 1, 2, 3, 4 (Line)	
Sensitivity	+5 / -15dBV External potentiometer adjust
Impedance	>13k
Input headroom	12dBV
Connector	RCA female. Input 1 and 2 with Euroblock stack
Type	Unbalanced
Input 5, 6, 7, 8 (Mic/Line)	
Sensitivity	+0 / -50dBV External potentiometer adjustment
Impedance	>24k electronically balanced
Input headroom	12dBV
Connector	Euroblock (Symmetrical)
Type	Balanced
Pagers	Input 7 and 8 (by RJ45 connector)
Phantom	+48VDC (rear panel switch)
CMRR	>60dB (20Hz - 20kHz)
Input 9 to 16 (Remote Input)	
Sensitivity	0 dBV without adjustment
Impedance	>24k electronically balanced
Input headroom	12dBV
Connector	RJ45 Connector
Type	Balanced
CMRR	>60dB (20Hz - 20kHz)
Outputs 1 to 16 (Line)	
Max output level	12dBV
Connector	Euroblock 3-pin
Type	Balanced
Headphones output	
Selectable output	From Out1 to Out16
Power	>200mW – 200Ω
Connector	Mini-Jack 3,5mm

General	
External mute	Normally open. Assignable to any output zone
Frequency response	<10Hz ~ 20kHz (+0dB / -0.5dB)
Output noise floor (FFT)	>110dB (from 20Hz to 20kHz)
THD + Noise	< 0.005% (1kHz, 1Vrms)
Crosstalk	>90dB, 20Hz - 20kHz
CMRR	>60 dB Typical
Flatness	Better than ± 0.1 dB
PROCESSING	
Input level (x16)	
Volume	From Off to 0 dB
Mute	On-Off
Metering	Vumeter post fader
Stereo	On-Off (Inputs 5 to 8)
Polarity	On-Off
High pass filter	50Hz to 150Hz (Inputs 5 to 8)
Frequency shifter	On-Off; 5Hz (Inputs 5 to 8)
Noise gate (x4)	
Inputs	Input 5 to 8, Bypass ON - OFF
Threshold	From -80dBV to +12dBV
Depth	From 0 dB to 80 dB
Attack	From 0.1ms to 500ms
Hold	From 10ms to 3000ms
Release	From 10ms to 1000ms
Input EQ (x16)	
Type	Baxandall 3-way EQ
Gain	-10dB ~ +10dB in 0.1dB steps
Frequency	Low 200Hz Mid 1kHz High 6.3kHz
Output level (x16)	
Volume	From Off to 0 dB
Mute	On-Off
Metering	Vumeter post fader
Stereo	On-Off
Polarity	On-Off
Output EQ (x16)	
Type	Baxandall 3-way EQ
Gain	-10dB ~ +10dB in 0.1dB steps
Frequency	Low 200Hz Mid 1kHz High 6.3kHz
Output graphic EQ (x16)	
Type	8-Band Graphic EQ
Gain	-10dB ~ +10dB in 0.1dB steps
Frequency	63Hz, 125Hz, 250Hz, 500Hz, 1kHz, 2kHz, 4kHz, 8kHz
Output compressor (x16)	
Bypass	On-Off
Mode	Compressor / Limiter
Threshold	-36 dB to +12 dB
Ratio	1 to 100
Knee	Soft / Hard
Attack	0.1ms to 500ms
Release	10ms to 1000ms
Make-up gain	0 dB to 10 dB

Output delay (x8)	
Outputs	1 to 8
Bypass	On-Off
Delay	0 to 300ms
Unit	ms, meters, feet
Output crossover (x8)	
Outputs	1 to 8
Bypass	On-Off
Mode	High Pass Filter / Low Pass Filter
Frequency	20Hz to 20kHz
General volume	
Volume	From Off to 0dB
Selectable outputs	Out 1 – Out 16
Ducker	
Input	IN5 to IN8. In 7 and 8 selectable: DUCKER or PAGER
Outputs	Selectable: 1-16 zones
Priority	Four levels (1max-4min)
Priority volume	-40 dB to +6 dB
Threshold	-80dB to +12dB
Depth	0dB to 80 dB
Attack	5ms to 2000ms
Release	50ms to 3000ms
Hold	10ms to 3000ms
Pager	
Input	IN7 and IN8 selectable: DUCKER or PAGER
Outputs	Selectable: 1-16 zones
Functions	Two function buttons (F1, F2)
Priority	Four levels (1max-4min)
Priority volume	-40 dB to +6 dB
Chime volume	-12dB to +0dB
Chime melody	None, Melody 1, Melody 2
Depth	0dB to 80 dB
Attack	5ms to 2000ms
Release	50ms to 3000ms
Pilot panels	
General	On-Off, Public, Label, Users and Zone
Volume control	On-Off, Label and Style
Source selection	On-Off, Label and Allowed sources
Equalizer	On-Off, Label, and Style
Colour	Controls, Text and Background

OTHERS	
Mechanical	
Dimensions	482,6 x 88,0 x 210,0mm / 19.0" x 3.5" x 8,3" (WxHxD)
Weight	3,66kg / 8.07 lb.
Power supply	
Mains	90-240 VAC, 50-60Hz
Power consumption	20W
Connectivity	
Management Connectivity	Ethernet Base-Tx 10/100Mb Auto X-Over CAT5 up to 100m
Remote bus	RS485
Aux. Power Supply for Remotes	+12VDC, 0,6A max. (short circuit protected)
Programming and control	Hangar (embedded web application), Ecler pilot (Andorid/iOS application), TPNET (UDP/RS232)

All product characteristics are subject to variation due to production tolerances. **NEEC AUDIO BARCELONA S.L.** reserves the right to make changes or improvements in design or manufacture that may affect these product specifications.

For technical queries please contact your supplier, distributor or complete the contact form on our website under Support / [Technical Query](#).

Motors, 166-168 08038 Barcelona - España - (+34) 932238403 | information@ecler.com | www.ecler.com