



PERFORM-VE

Revolutionary Vocal Manipulator with MIDI-Pitch-Controlled Sampling, Vocal Synth and One-Button Drum Looper

User Manual



Table of Contents

Important Safety Instructions	3
Legal Disclaimer	3
Limited warranty	3
1. Introduction	4
2. Update your Device!.....	4
3. Connection Diagram	5
4. Front Panel	6
4.1 The Set Button	6
4.2 The Headphone Button	8
5. Effects	9
5.1 Double	9
5.2 Morph	9
5.3 HardTune	12
5.4 XFX.....	13
5.5 Echo	16
5.6 Filter.....	17
5.7 Tap (Tempo).....	18
6. Looper	19
7. Sample	22
8. Presets	23
9. I/O Section	24
9.1 AUX Input.....	24
9.2 Switch3/Switch6 (Pedal) In	24
9.3 USB Audio.....	24
9.4 RoomSense	25
Appendix A: Effect Quick Reference Chart	26
Appendix B: MIDI Implementation.....	27
Appendix C: General	28

EN Important Safety Instructions



Terminals marked with this symbol carry electrical current of sufficient magnitude to constitute risk of electric shock.

Use only high-quality professional speaker cables with ¼" TS or twist-locking plugs pre-installed. All other installation or modification should be performed only by qualified personnel.



This symbol, wherever it appears, alerts you to the presence of uninsulated dangerous voltage inside the enclosure - voltage that may be sufficient to constitute a risk of shock.



This symbol, wherever it appears, alerts you to important operating and maintenance instructions in the accompanying literature. Please read the manual.



Caution

To reduce the risk of electric shock, do not remove the top cover (or the rear section). No user serviceable parts inside. Refer servicing to qualified personnel.



Caution

To reduce the risk of fire or electric shock, do not expose this appliance to rain and moisture. The apparatus shall not be exposed to dripping or splashing liquids and no objects filled with liquids, such as vases, shall be placed on the apparatus.



Caution

These service instructions are for use by qualified service personnel only. To reduce the risk of electric shock do not perform any servicing other than that contained in the operation instructions. Repairs have to be performed by qualified service personnel.

1. Read these instructions.
2. Keep these instructions.
3. Heed all warnings.
4. Follow all instructions.
5. Do not use this apparatus near water.
6. Clean only with dry cloth.
7. Do not block any ventilation openings. Install in accordance with the manufacturer's instructions.
8. Do not install near any heat sources such as radiators, heat registers, stoves, or other apparatus (including amplifiers) that produce heat.

9. Do not defeat the safety purpose of the polarized or grounding-type plug. A polarized plug has two blades with one wider than the other. A grounding-type plug has two blades and a third grounding prong. The wide blade or the third prong are provided for your safety. If the provided plug does not fit into your outlet, consult an electrician for replacement of the obsolete outlet.

10. Protect the power cord from being walked on or pinched particularly at plugs, convenience receptacles, and the point where they exit from the apparatus.

11. Use only attachments/accessories specified by the manufacturer.



12. Use only with the cart, stand, tripod, bracket, or table specified by the manufacturer, or sold with the apparatus. When a cart is used, use caution when moving the cart/apparatus combination to avoid

injury from tip-over.

13. Unplug this apparatus during lightning storms or when unused for long periods of time.

14. Refer all servicing to qualified service personnel. Servicing is required when the apparatus has been damaged in any way, such as power supply cord or plug is damaged, liquid has been spilled or objects have fallen into the apparatus, the apparatus has been exposed to rain or moisture, does not operate normally, or has been dropped.

15. The apparatus shall be connected to a MAINS socket outlet with a protective earthing connection.

16. Where the MAINS plug or an appliance coupler is used as the disconnect device, the disconnect device shall remain readily operable.



17. Correct disposal of this product: This symbol indicates that this product must not be disposed of with household waste, according to the WEEE Directive (2012/19/EU) and your national law. This product

should be taken to a collection center licensed for the recycling of waste electrical and electronic equipment (EEE). The mishandling of this type of waste could have a possible negative impact on the environment and human health due to potentially hazardous substances that are generally associated with EEE. At the same time, your cooperation in the correct disposal of this product will contribute to the efficient use of natural resources. For more information about where you can take your waste equipment for recycling, please contact your local city office, or your household waste collection service.

18. Do not install in a confined space, such as a book case or similar unit.

19. Do not place naked flame sources, such as lighted candles, on the apparatus.

20. Please keep the environmental aspects of battery disposal in mind. Batteries must be disposed-of at a battery collection point.

21. Use this apparatus in tropical and/or moderate climates.

LEGAL DISCLAIMER

MUSIC Group accepts no liability for any loss which may be suffered by any person who relies either wholly or in part upon any description, photograph, or statement contained herein. Technical specifications, appearances and other information are subject to change without notice. All trademarks are the property of their respective owners. MIDAS, KLARK TEKNIK, LAB GRUPPEN, LAKE, TANNOY, TURBOSOUND, TC ELECTRONIC, TC HELICON, BEHRINGER and BUGERA are trademarks or registered trademarks of MUSIC Group IP Ltd. © MUSIC Group IP Ltd. 2017 All rights reserved.

LIMITED WARRANTY

For the applicable warranty terms and conditions and additional information regarding MUSIC Group's Limited Warranty, please see complete details online at music-group.com/warranty.

1. Introduction

Thank you for purchasing Perform-VE!

Your new mic stand-mounted vocal processor opens up a world of sound creation and performance opportunities.

Starting with our Adaptive Tone (automatic EQ, De-Essing, Gating and Compression), your voice will punch through the mix and sound great in any environment.

Next up, an impressive assortment of transformations await your voice: HardTune Pitch Correction, Doubling, Shift and Gender Morphing all work together to create whatever modern lead vocal sound you can dream up.

Perform-VE also generates MIDI Voices to accompany your Lead. MIDI Voices can be pitch-perfect vocal harmonies, virtual analog vocoder voices, or VS Synthesis samples that you record on the fly. Simply play notes on a connected MIDI controller keyboard and you can have up to eight of these MIDI voices singing along with your Lead.

You also get XFX for stutter, rhythmic, ring modulation and flanger effects, Echo for spacious reverbs + beat-synced delays, and Filter for a selection of transducer and sweepable filters. With all this at your command, you'll quickly generate striking vocal effects and exciting, fresh sounds that will take your music to new levels.

But wait, there's more!

Perform-VE also includes a Drum and Audio Looper. With several different kick, snare and hi-hat sounds available, you can easily build a beat and then record a synchronized audio loop from Perform-VE's internal signal path. Just tap and vocalize.

Read the Quick Start!

If you've read the Quick Start Guide that came in the box, hooked up a microphone, and can hear your music and vocals coming through the outputs, you are already skimming the top features of Perform-VE. If you want to get into Perform-VE's deeper capabilities with this reference manual, we'll need to do a little more set up. Don't worry – it won't take long!

2. Update your Device!

It is HIGHLY recommended that you update the firmware on your Perform-VE before first use.

To update your firmware, you'll need both a USB driver (PC only) and our VoiceSupport 2 program. Both can be found at tc-helicon.com/products/perform-ve/support/

PC Users

1. Download both the USB driver and VoiceSupport 2
2. Install the USB driver (restart if prompted)
3. Install VoiceSupport 2 (restart if prompted)
4. Connect your Perform-VE to your computer with the supplied USB cable
5. Power up Perform-VE
6. Start VoiceSupport 2
7. Follow the prompts to update your firmware

Mac Users

You will not need the USB driver. Download VoiceSupport 2 and follow steps 3-7 above.

3. Connection Diagram

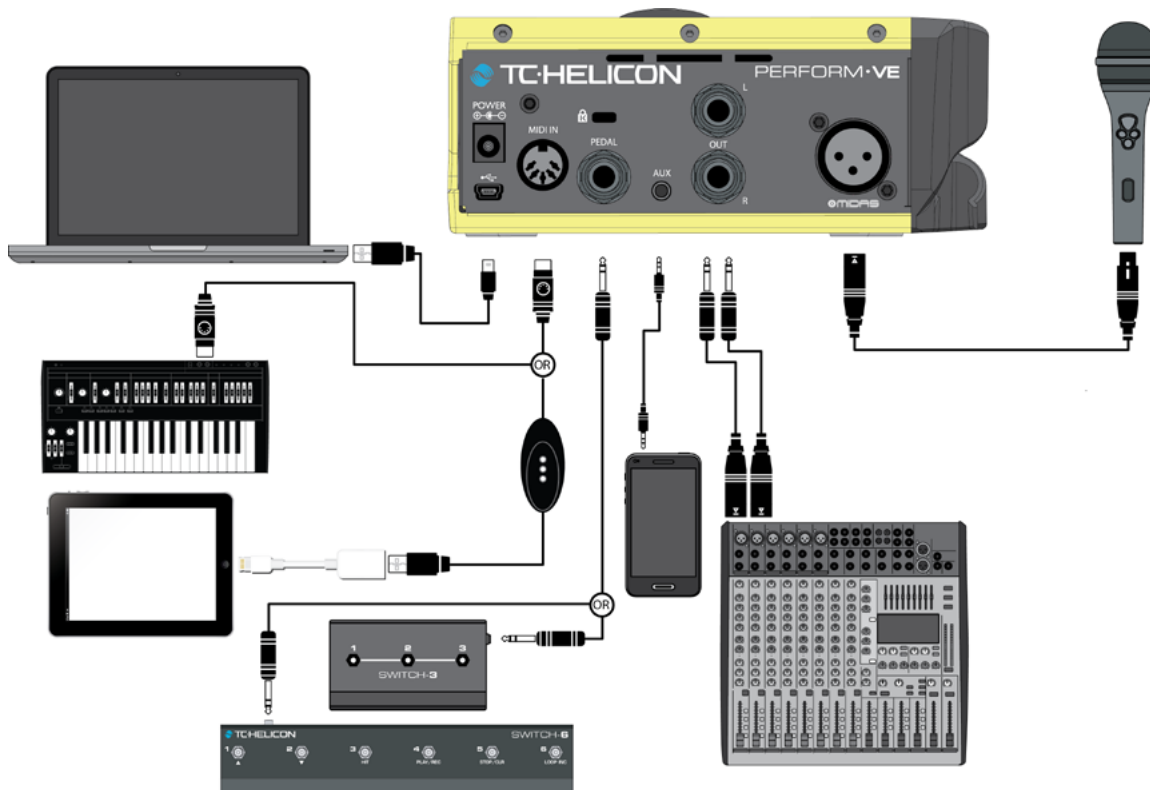

Perform-VE has a lot of connectivity:

- MIDI data is received via the mini-USB port or the 5-Pin MIDI socket.
- MIDI data is transmitted via the mini-USB port.
- The PEDAL input allows you to connect a Switch-3 or Switch-6 (sold separately) to change presets, toggle effects and control the LOOPER and SAMPLE features.
- The AUX input lets you mix stereo audio tracks with Perform-VE's output.
- The balanced stereo outputs allow connection to any 1/4" input equipped mixer or powered speaker system.
- The XLR input is MIDAS microphone preamplifier equipped, providing the much-loved MIDAS soft-clipping characteristic sound when pushed hard.

For learning purposes, we recommend that you connect a MIDI keyboard to your Perform-VE while you track along with this reference manual. Your MIDI keyboard will ideally be connected directly to Perform-VE's 5-Pin MIDI port as shown above.

Alternatively, your MIDI keyboard can be connected via USB cable to a laptop running music software that features a MIDI soft THRU capability. You would then connect Perform-VE to the laptop via a second USB cable and configure your DAW to take incoming MIDI from the USB MIDI keyboard and pass it on to Perform-VE's USB port. See your respective software manual for details on how to set up your particular system.

4. Front Panel

Now that your Perform-VE is set up and connected to the devices of your choosing, we're going to take a quick tour of the front panel, explaining what each of the buttons do without getting too deep in any details just yet. Don't worry – we'll go feature diving soon enough!

One Knob To Rule Them All

By default, Perform-VE's Control Knob edits the mix between the MIDI Voices and your Lead Voice. It applies to all three presets and is not stored when Perform-VE is turned off.



LEAD Voice: Your voice. Enhanced and extremely altered, just how you want it!

MIDI Voices: Up to 8 MIDI Note controlled voices generated by Perform-VE to accompany your LEAD Voice.

MIDI Voices are Harmony, Vocoder or VS Synthesis Voices.

The graphic above shows equal levels of MIDI and LEAD as displayed on the LED Ring. From here you can dial down the blue MIDI level by turning the knob counter-clockwise, or dial down the green LEAD level by turning the knob clockwise. Whichever level you turn down, the other one will stay at max volume.

Effects

Perform-VE makes some of the wildest and most complex sounds that TC-Helicon has ever made possible. There's a lot to discover by simply pushing buttons and combining sounds, but we'll give you an overview of the basics here, starting with the six effects buttons, as shown below:



Toggleing the Effects

Quickly pressing and releasing any one of the FX buttons will toggle the associated effect on and off. The LED ring will switch to an alternate display mode while the button is down. There's a reason for this momentary flash, and we'll explain it now.

Real-time Control of Effect Parameters

Perform-VE was designed to allow instant access to 21 different effect parameters without navigating through menus.

Each effect button is labeled with light gray text in one or more corners of the button. For example, if you press "Level" in the top left corner of the Double button, and turn the Control Knob while it's pressed, you'll adjust the amount of

doubling. Alternatively, if you hold Style in the bottom right corner of the Double button, once that button pulses, you'll be able to change the doubling style when you turn the Control Knob.

When a parameter edit is underway...

- The LED ring will display the currently selected parameter value,
- The Control Knob will edit this parameter, ranging (clockwise) from min to max, and
- The pressed FX button will pulse on and off. At this point you won't need to keep holding it down to continue editing.

Pressing any button (including the button that is pulsing) will quit the edit mode.

Styles and Mods

In addition to parameters like Level, Shift, Gender, Mode, Key, Div, Delay and Reverb, you'll see that four of the effects have a Style parameter. Styles are essentially mini-presets for the effect in question. Changing any style will instantly update a number of deeper effect parameters that are not available for direct Control Knob editing. Style selections appear on the LED Ring as single color-coded LEDs.

Mods are related to the currently selected Style. They appear as levels on the LED Ring, colored to match the Style. You can think of each mod as custom 'Tweak' parameter matched to the Style in question.

4.1 The Set Button



Configures: Microphone Input Level, MIDI Channel Select, MIDI Split Point Select, & More...

Once a microphone and a MIDI keyboard are connected to your Perform-VE, it's time to ensure that the audio and MIDI settings are correct. You achieve this with the **SET** button.

The SET button performs many functions in your Perform-VE. By itself, the SET button configures the mic input level and sets the MIDI channel and split-point used to control the notes, vocoder and sample features of your unit.

Mic Gain Setting

The actual signal level coming from your microphone can vary depending on what type of microphone you have connected and how loudly you vocalize (speak/sing/shout/shriek) into it. The **Auto-Gain** procedure is the easiest way to ensure the microphone preamplifier level set within your Perform-VE is calibrated to match your mic and vocal technique, but you have the freedom to set the Mic Gain level manually if you prefer.

Auto-Gain

Press and Hold the SET button to activate the Auto-Gain procedure and vocalize into the microphone at your typical loudest volume. After several seconds the SET button will flash red, indicating that the procedure is complete.

You will see that the LED to the right of the SET button changes color when you vocalize into the microphone.

This LED is a VU Meter, with the following color codes:



Green
-23 dB ... -13.5 dB
Good Level



Yellow
-13.5 dB ... -7.5 dB
Hot level, but still okay.



Orange
-4 dB ... 0 dB
Soft-clipping:
Midas Tone.



Red
0 dB
Hard-clipping!

If you find the Auto-Gain procedure set the input trim too low or high for your liking, you can always run Auto-Gain again or you can set the gain **manually**.

Manual Gain

Press and Release the SET button to edit the Manual Gain with the Control Knob.

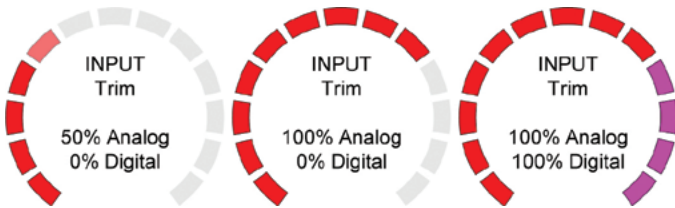

The red LED segments indicate gain provided by Perform-VE's analog microphone preamplifier circuit. When the mic pre is at maximum gain, further gain is possible via digital amplification (the remaining 4 magenta LED segments).

Once you stop editing with the Control Knob, the LED ring will return to the MIDI/LEAD mix display after two seconds. You can then vocalize into your microphone and confirm the gain settings are correct for your application.

HINT: Red in VU meter LED is not a good thing as it means hard clipping and digital distortion! Reduce the microphone gain and try again if you see the VU LED turning red when you are vocalizing.

MIDI Channel

The MIDI channel that Perform-VE responds to is set **if** a MIDI note event is received **while** the SET button is held down.

To set the MIDI Channel (without a split point):

- **Press and Hold** the SET button,
- Play a single MIDI note on your controller,
- Release the SET button.

Don't worry about having to repeat the Auto-Gain on the microphone – these steps will not overwrite your previous microphone level settings while the SET button is down, provided you a MIDI note is received while SET is held down.

When complete, you can verify Perform-VE is set to receive on the correct MIDI channel for your keyboard by playing notes and monitoring the SET button; the SET button will flash red whenever MIDI note events are received on the configured MIDI channel.

SET + Preset 1: Adaptive Tone



Holding down the SET button and pressing Preset 1 will toggle Adaptive Tone, with the VU meter LED as an indicator.
RED: Off
GREEN: On

Tone automatically adds EQ (equalization), Compression, De-Ess and Gate to your overall vocal sound. Tone is enabled by default and we highly recommend leaving it on.

EQ helps to shape the tone of your voice to fit into a musical mix. We remove some of the low "mud" frequencies and boost the highs for "sparkle" or "air". Every recording you hear has some manner of EQ on the lead vocal (and pretty much everything else too).

Compression reduces the difference in volume between the loudest and quietest notes. This gives you a more even sound that helps your vocal sit better in the local mix. It's almost unheard of for vocals to go uncompressed in modern music, both recorded and live.

De-Ess gets rid of harsh "S" sounds and makes them sound more pleasing. De-Ess goes hand in hand with Compression, since Compression can make "S" sounds a bit more pronounced in the mix.

Gate "shuts off" an audio input when it falls below a certain volume. This works great on things like drums where you want the drum hit to come through, but then have the mic silent in between hits.

For vocals, we don't want to go as far as shutting your mic off but we do want to reduce the volume (gain) of the mic when you're not singing so that feedback becomes less likely.

Since Perform-VE replaces EQ and effects that are often added by a live sound technician, you'll want to make sure that the mixer channel you plug Perform-VE into has a flat EQ (not altering any frequencies) and that any effects are turned off.

SET + Preset 2: +48 V (Phantom Power)



Holding down the SET button and pressing Preset 2 will toggle phantom power (+48 V), with the VU meter LED as an indicator.
RED: Off
GREEN: On

If you have a condenser mic, it'll need power to function. Enable +48 V to use it with your Perform-VE.

If you're not sure what kind of mic you have, but you don't hear any sound, it's ok to try +48 V - it won't damage a dynamic microphone.

SET + Preset 3: Mic Control

Holding down the SET button and pressing Preset 3 repeatedly will cycle through Mic Control settings, with the VU meter LED showing which mode you're in.

RED: Mic Control Off

Use this when you have a condenser microphone. If you have another Mic Control mode set, you may inadvertently activate buttons on the box as you sing.

GREEN: MP-75 Mode

On your TC-Helicon MP-75 Microphone, the single Mic Control button cycles the preset selection. You can reassign the Mic Control button by holding the button and then pressing the corresponding button on Perform-VE that you'd like to control.

For example, if you hold the Mic Control then press the Reverb button, the MP-75 will now toggle Reverb on and off.

YELLOW: MP-76 Mode

In MP-76 mode, the Mic Control button cycles the preset selection as it does in MP-75 mode. The remaining three buttons default to toggle the following effects on your Perform-VE:

- **Left** toggles ECHO.
- **Right** toggles FILTER.
- **Bottom** toggles XFX.

NOTE: If you have a TC-Helicon MP-76 connected but choose MP-75 mode instead, the lower three buttons will not operate.

The MP-75 and MP-76 buttons can be reassigned to control the following:

- DOUBLE
- MORPH
- HARDTUNE
- XFX
- ECHO
- FILTER
- LOOPER Record/Play/Erase
- SAMPLE record
- SAMPLE play
- Preset 1
- Preset 2
- Preset 3
- Tap Tempo

SET + Double: MIDI SYSEX Dump Current Preset

Holding down the SET button and pressing the DOUBLE button outputs the sysex of the current active preset parameters.

SET + Tap

Holding down the SET button and pressing the Tap button toggles drum quantizing on and off.

SET + Kick: Erase Kick loop component

SET + Snare: Erase Snare loop component

SET + Headphone: Erase Hi-hat loop component

SET + Loop: Erase Audio loop component

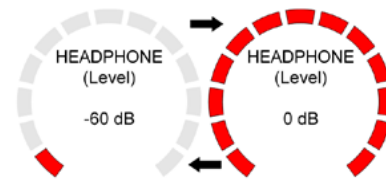
4.2 The Headphone Button

When held down, **HEADPHONE Level** adjusts the volume of the headphone jack.

Range: -60 to 0 dB

When the looper button is lit or pulsing, the headphone button plays the hi-hat. The loop needs to be erased to be able to adjust the headphone level.

Now that the basics are out of the way, let's check out Perform-VE's effects!

5. Effects

5.1 Double



Applies to: LEAD Voice

Double simulates the classic “double tracked” studio sound that’s common on recordings of all genres. **Double Style** selections can include Octave Up and Octave Down voices, for an even thicker effect. Hold style to edit.

Double Style

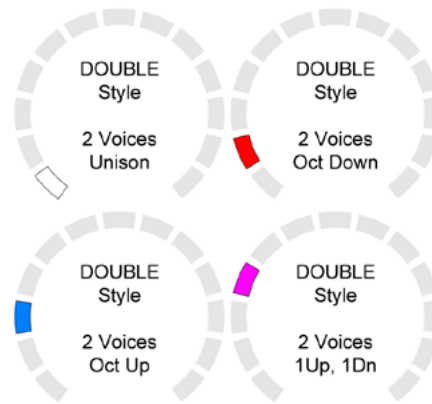

Double Level

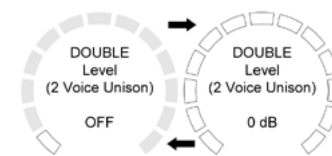

Double Level changes the amount of doubled voice, relative to your lead vocal. Hold level to edit.

On the ring, Level is indicated by one up to all LEDs lit, in the color of the current style.

Range: Off, -10 to 0 dB

5.2 Morph



Applies to: LEAD Voice
(Shift & Gender),
MIDI Voice (Mode & Style)

“Morphing is a special effect in motion pictures and animations that changes (or morphs) one image or shape into another through a seamless transition. Most often it is used to depict one person turning into another through technological means or as part of a fantasy or surreal sequence.” (Wikipedia)

Perform-VE’s Morph effect does exactly this to your voice: you can morph your lead voice into a giant, a mouse, or a spaced out alien (and beyond) using the Shift and Gender parameters, while also morphing your MIDI voices into choirs of angels, robots, zombies or whatever you dream up using the Mode and Style parameters.

Morph Style

Morph Style sets the MIDI Voices to be either Notes harmony voices or Synth Vocoder voices. There are two styles of Notes harmony (natural or warp), and eight different Synth Vocoder styles to choose from.

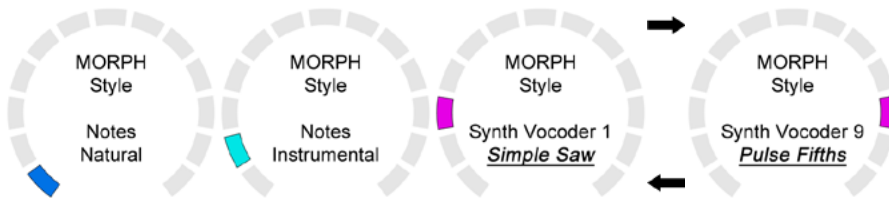

Notes

Notes harmony voices are created from either your own voice, or a VS Synthesis sample (vocal sample synthesis) that you create with Perform-VE’s innovative new **VS Synthesis** sampler technology (covered later in this manual).

Formants are the unique resonant frequencies that give your voice its characteristic sound. When set to **Natural** operation, the Notes Harmony voices will retain the formant characteristics of your lead vocal. When set to **Warp**, the voices will have their formant characteristics expanded or compressed depending on the actual MIDI notes you play, making for tonal transformations that are striking, unexpected and possibly unreal sounding when compared to the original. Try it and hear for yourself!

Notes Natural is the default mode for Perform-VE’s MIDI Voices. As long as MORPH and SAMPLE are turned off, you will hear natural shifted harmony voices whenever you vocalize and send MIDI Notes to Perform-VE.

When MORPH is turned on, the MIDI Voice mode changes to reflect the MORPH Style – you can keep the MIDI Voices Natural, make them Warped, or replace them with Synth Vocoder voices as you see fit.

Synth Vocoder

Perform-VE has a dual oscillator synth vocoder hidden inside. When Synth Vocoder styles are chosen, the synthesizer will generate up to eight articulated synth voices to render the MIDI notes you play, and will also generate a ninth Lead synth voice that follows the pitch of your voice.

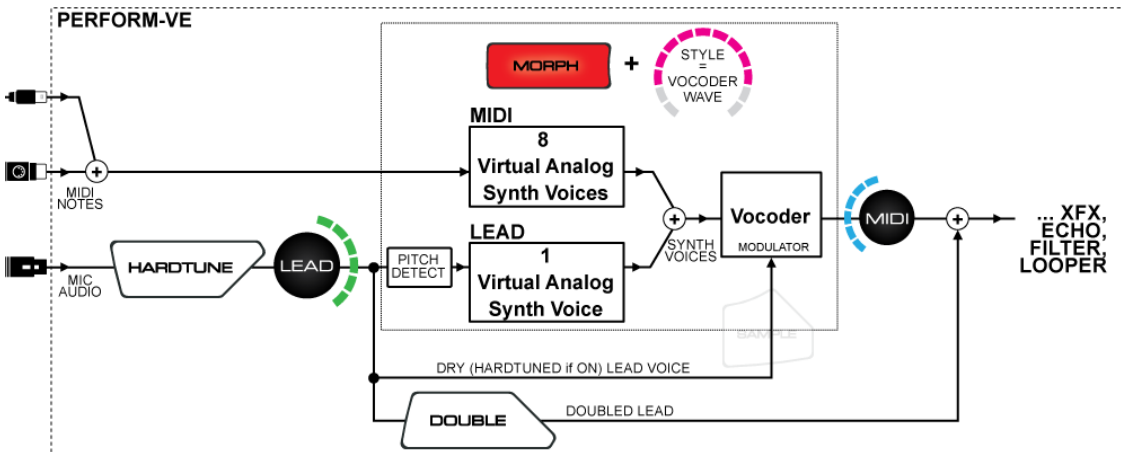

The graphic above assumes a sample hasn't been recorded. In this case, your Lead vocal gets a dedicated synth voice and also acts as the modulator (shaping signal) for the vocoder.

Enabling the SAMPLE button changes the way the vocoder operates:

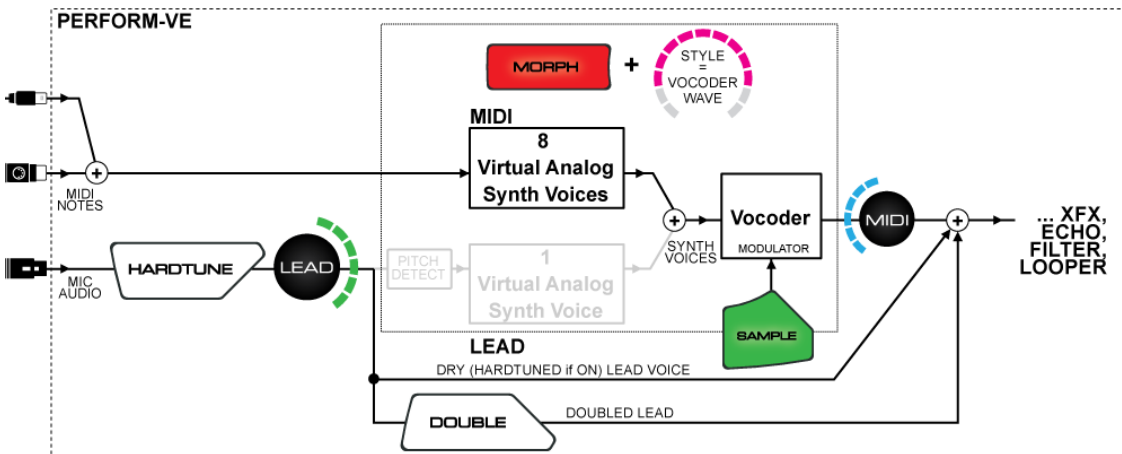

We'll cover the SAMPLE features in detail later on. For now, it's enough to know that when the SAMPLE button is green, the recorded sample acts as the modulator of up to 8 synthesizer voices, and your lead Vocal passes through to the rest of the effects aboard Perform-VE.

Synth Vocoder

Each one of the Synth Vocoder styles is actually a synthesizer preset (or patch), named accordingly:

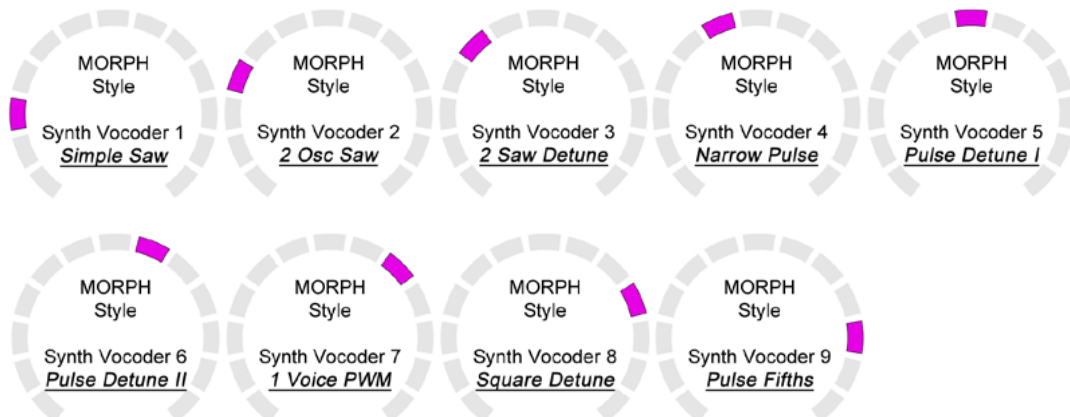

Morph Mode

Morph Mode controls the Mono/Poly setting of the Notes, Vocoder and Sample MIDI voices. Hold mode to edit.

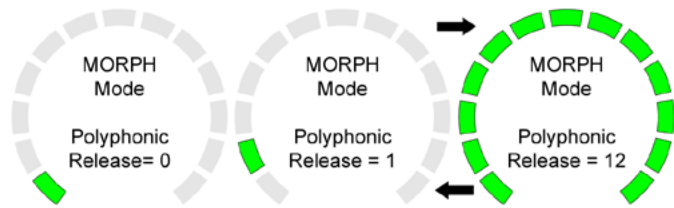

Green LED selections set the MIDI voices to Poly mode, and adjust their release time (how long voices will take to fade out after you release their controlling key). Bear in mind you will need to keep singing (play a long enough sample) after the note release to hear the fade out.

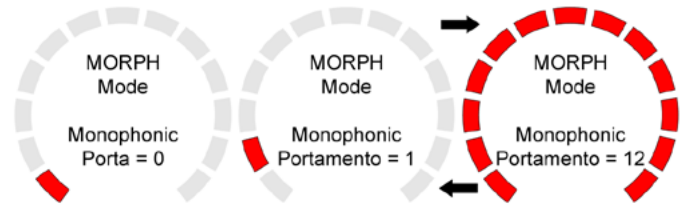

Red LED selections set the MIDI Voices to Mono mode and adjust the portamento time from 0 to long. Portamento time is how long it takes to glide from one note's pitch to the next.

Morph Shift

Morph Shift pitch shifts your lead voice up or down by a set number of semitones (+/- 12). Hold shift to edit.

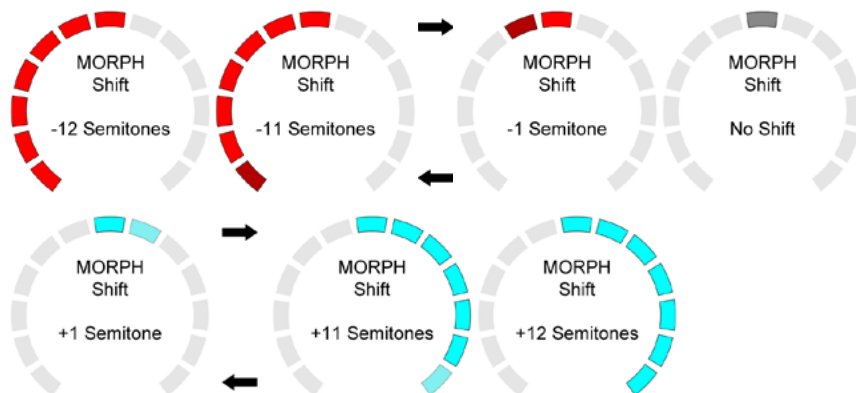

NOTE: If you control Morph Shift via MIDI Continuous Controller (CC) messages, the range is +/- 36 semitones for even more extreme effects and automated sweeps.

Morph Gender

Morph Gender expands and compresses the formant signature of your voice to make it sound more male (negative values) or female (positive values). Hold gender to edit.

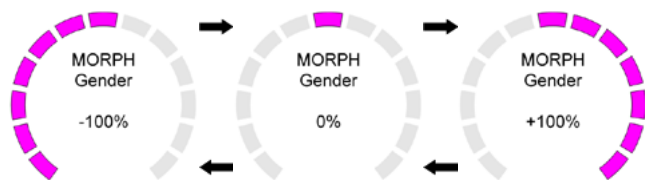

5.3 HardTune



Applies to: LEAD Voice

HardTune provides pitch correction that varies from subtle all the way up to T-Pain™ style tuning. Generally speaking, pitch correction alters your Lead vocal pitch to fit within a selected Key and Scale.

If all you care about is keeping your voice within the defined black and white notes on the piano keyboard, select the Chromatic scale, which is the same for all keys.



CHROMATIC SCALE

On the other hand, if your song is in the key of C, you'd likely get more musically pleasing results by selecting the C Pop Major scale.

This scale is the C Major scale (all white keys) with an added flat 7th for the blues-influenced variations common in pop music.



C POP MAJOR SCALE

When transposed to other keys, the Pop Major scale can definitely look unusual. Here it is in the key of C#, just one semitone up from C.



C# POP MAJOR

When using the Pop Major Scale, Perform-VE should be set to the correct key for your composition. You can set this manually, or you can set the key to **NaturalPlay** to have Perform-VE automatically set the correction key based on the chords it detects in the incoming MIDI or audio (Aux input).

HardTune Key

HardTune Key selects NaturalPlay Pop Major Scale, Pop Major Scale in all 12 keys, or Chromatic scale. Hold key to edit.

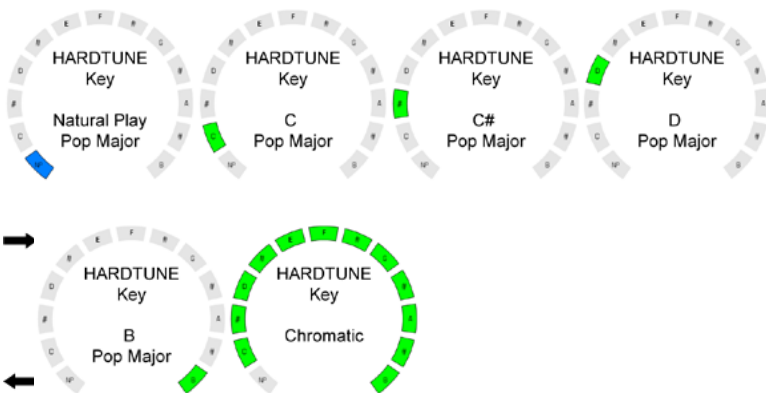

HardTune Amount



HardTune Amount changes the amount of pitch correction applied to your lead vocal. Higher amounts mean more T-Pain™ for you. Hold amt to edit.

Range: Natural to Slammed!

5.4 XFX

XFX stands for 'EXTREME EFFECTS'. . . it lives up to the name, as we'll now explain.



Applies to: Lead Vocal, MIDI Voices
 Looper Audio (Flange, SideChain
 Pumping & LPF/HPF only)
 Looper Drums (Flange & LPF/HPF only)

XFX Style

There are seven different XFX styles: Stutter effect, Chopper effect, Ring Modulation, Flanging and even a SideChain Pumping Compressor. Each XFX Style has two dedicated mod parameters that you can apply to tailor the XFX in question to suit your current inspiration. Hold style to edit.

XFX Style: Stutter



Stutter is an extreme effect that chops incoming audio into smaller time divisions and quickly repeats those divisions, resulting in a stuttering sound. At the largest time divisions you'll hear the audio as rhythmic repeats, while at the smallest time divisions, the audio cycles so quickly that it produces a different pitched tone (or buzz) for each division.

Stutter will be armed for sampling your Lead vocal as soon as you select the Style. Just vocalize and stuttering will begin!

Stutter Mod 1: Division

Stutter Mod 1 controls the size of the stutter division in real time. The **Quarter Note** division is indicated by a white LED, while all other divisions are light blue LEDs. Hold mod1 to edit.

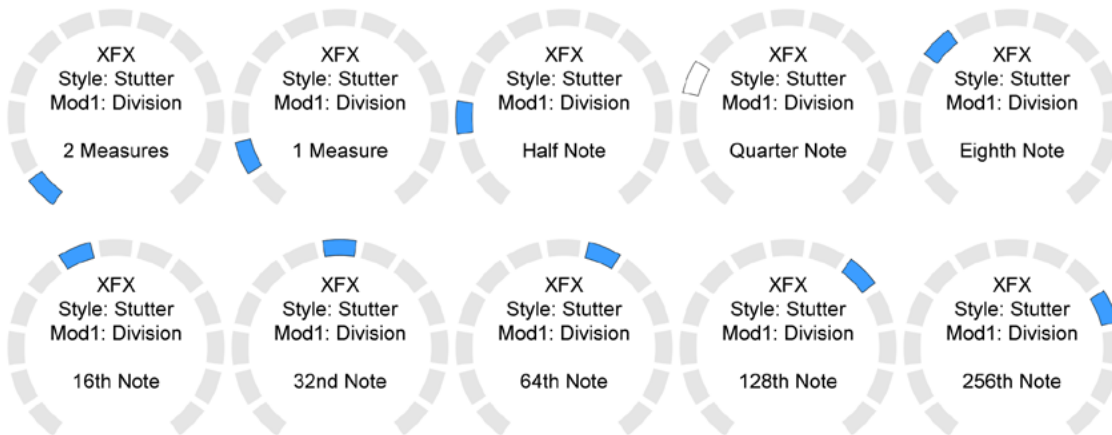

Stutter Mod 2: Level

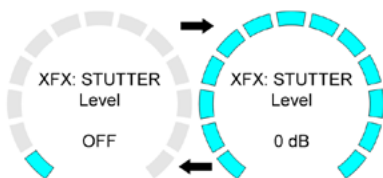

Stutter Mod 2 changes the level of the stutter audio, relative to your Lead vocal. Hold mod2 to edit.

On the ring, Level is indicated from one up to all LEDs lit up in Cyan.

Range: Off, -10 to 0 dB

Pausing Stutter

You can put the Stutter effect on hold at any time by turning the XFX toggle off. Your sample won't be lost while the effect is turned off.

Recording a new Stutter Sample



For even faster re-recording of the stutter sample, double-click the **style** corner button and this will instantly clear the sample and arm the Stutter effect to record a new sample.

AFX Style: Chopper



There are two Chopper styles: **Mono Chopper** and **Stereo Chopper**. At full depth, Mono will gate the level of the audio, while Stereo will alternate (ping-pong) the audio between Perform-VE's left and right stereo outputs. Both Chopper styles are beat-synchronized, of course!

Chopper Mod 1: Division

Chopper Mod 1 controls the size of the Chopper's rhythmic division in real time. Hold mod1 to edit.

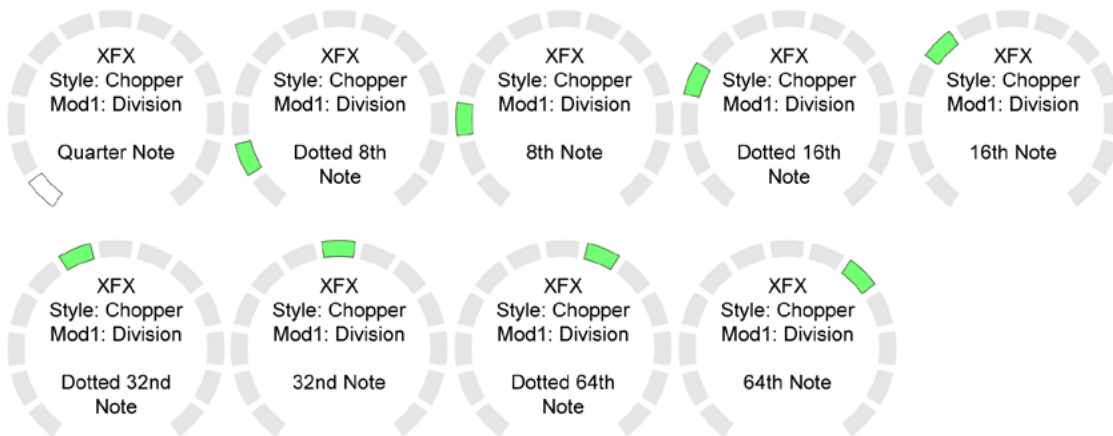

Chopper Mod 2: Depth

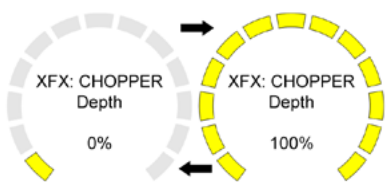

Chopper Mod 2 changes the depth of the volume modulation (gating), relative to your Lead vocal. Hold mod2 to edit.

On the ring, Level is indicated from one up to all LEDs lit up in Yellow.
Range: 0 to 100%

Range: 0 to 100%

AFX Style: Ring Mod



The Ring Modulator multiplies your lead vocal with an internally-generated sine wave to create a classic 'Dalek from Doctor Who' sound.

At full Ring Mod depth, you'll be ready to visit planet Skaro, but subtle amounts can also work wonders on a vocoder voice to bring out an old-school Electric Cylon Orchestra sound for a retro sci-fi clip or two.

Robots and aliens aside, a bit of Ring Mod will give any signal a gritty electronic characteristic that follows the pitch or melody of the input signal. It's very useful!

Ring Mod, Mod 1: Frequency

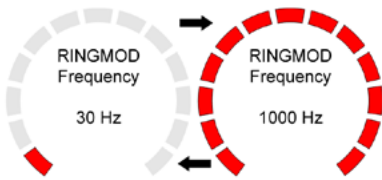

Ring Mod, Mod 1 controls the **frequency** (pitch) of the modulating sine wave. Sweep it across its range to apply a vintage radio tuning sound on your fixed pitch signal, or keep the frequency fixed while singing a melody to hear that 1950's UFO/Raygun sound. Hold mod1 to edit.

Range: 30 to 1000 Hz

Ring Mod, Mod 2: Level

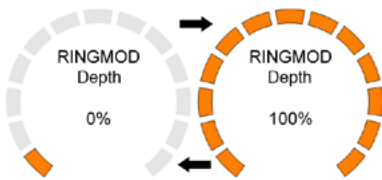

Ring Mod, Mod 2 controls the **depth** of the ring-modulated signal. Hold mod2 to edit.

Range: 0 to 100%

XFX Style: Flange

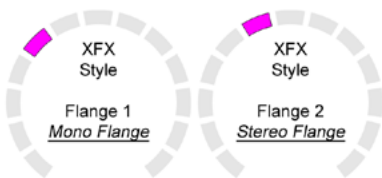

Flanging is an audio effect produced by mixing two identical signals together, with one signal delayed by a small and gradually changing amount.

Part of the flanged signal is fed back to the input, producing a resonance effect which further enhances the intensity of the sound.

Flange 1 (Mono Flange) is a negative feedback flange: the phase of the fed-back signal is inverted (made negative), producing a striking alternative to the classic sound of Flange 2 (Stereo Flange) which uses positive feedback.

Flange, Mod 1: Speed

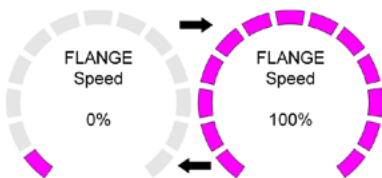

Flange Mod 1 controls the speed of the gradually changing delay time. You can take the flanging from a subtle slow 'Jet Plane' sweep variation all the way up to an extreme 'wowing' effect. Hold mod1 to edit.

Range: 0 to 100%

Flange, Mod 2: Depth

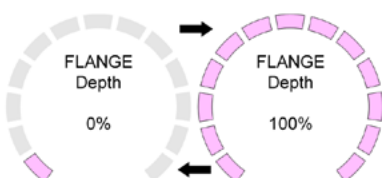

Flange Mod 2 controls the depth of the effect, from subtle to very obvious. Hold mod2 to edit.

Range: 0 to 100%

XFX Style: SideChain Pumping



The SideChain Pumping Compressor is meant to be used with the LOOPER's built in drum sequencer. When you are playing a beat, the SideChain Compressor will momentarily throttle back (compress) the volume of your Lead, MIDI and audio loop mix whenever the drums hit a certain threshold volume. This ensures your drums will always stand out in the mix. This effect is also called 'SideChain Pumping'.

SideChain Pumping, Mod 1: Compressor Threshold

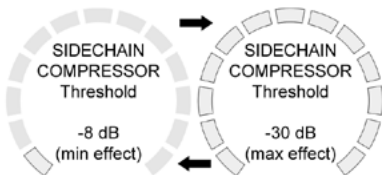

The SideChain Compressor reduces the level of the non-drums audio signal if the kick drum mix level exceeds a certain 'trigger' threshold value.

SideChain Pumping Mod 1 controls this compressor threshold. Lower threshold values mean a larger portion of the non-drums audio signal is compressed. Hold mod1 to edit.

Range: -8 dB to -30 dB

SideChain Pumping, Mod 2: Compressor Release Time

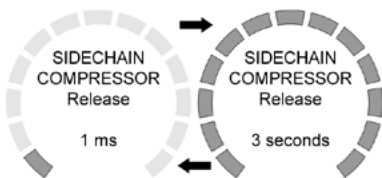

SideChain Pumping Mod 2 controls the Compressor Release Time. It lets you define how quickly the compressor acts on an incoming audio signal. When the input level falls below the compressor threshold, there is a delay between the compressor release and the input signal's return to full strength. This delay is the Release Time, and its amount is indicated on the LED Ring. Hold mod2 to edit.

Range: 1 ms to 3 seconds

5.5 Echo



Applies to: LEAD Vocal
MIDI Voices

Echo is a combined Delay and Reverb processor: Echo effects repeat your voice back to you in various ways and amounts, simulating the effect shouting into a mountain range (delay) or very large space (reverb). With Echo turned on, you'll get delay and reverb combined as you like them.

Echo Style

Echo Style changes the Reverb settings. The LEDs indicators are colored by type: two natural reverbs (Hall & Arena) and two electromechanical reverbs (Spring & Plate). Hold style to edit.



Echo Reverb

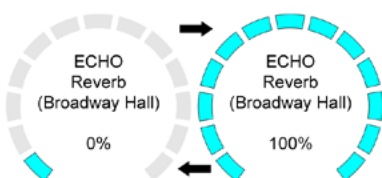

Echo Reverb is a master parameter that simultaneously edits the reverb's decay time and output level. Greater amounts will expand the perceived size of your reverberation, so you can make even a small plate reverb sound gigantic if you want. Hold reverb to edit.

Range: 0 to 100%

Echo Div

Echo Division controls both the Delay's rhythmic division and its type. Blue LED selections are Ping-Pong delays in which echoes 'bounce' between left and right in the stereo field, while green LED selections are delays in which echoes are heard on both sides of the stereo field. The red LED selection is a short single-repeat echo called a Slapback delay, useful for dialing in a retro 50's pop song vibe. Hold div to edit.

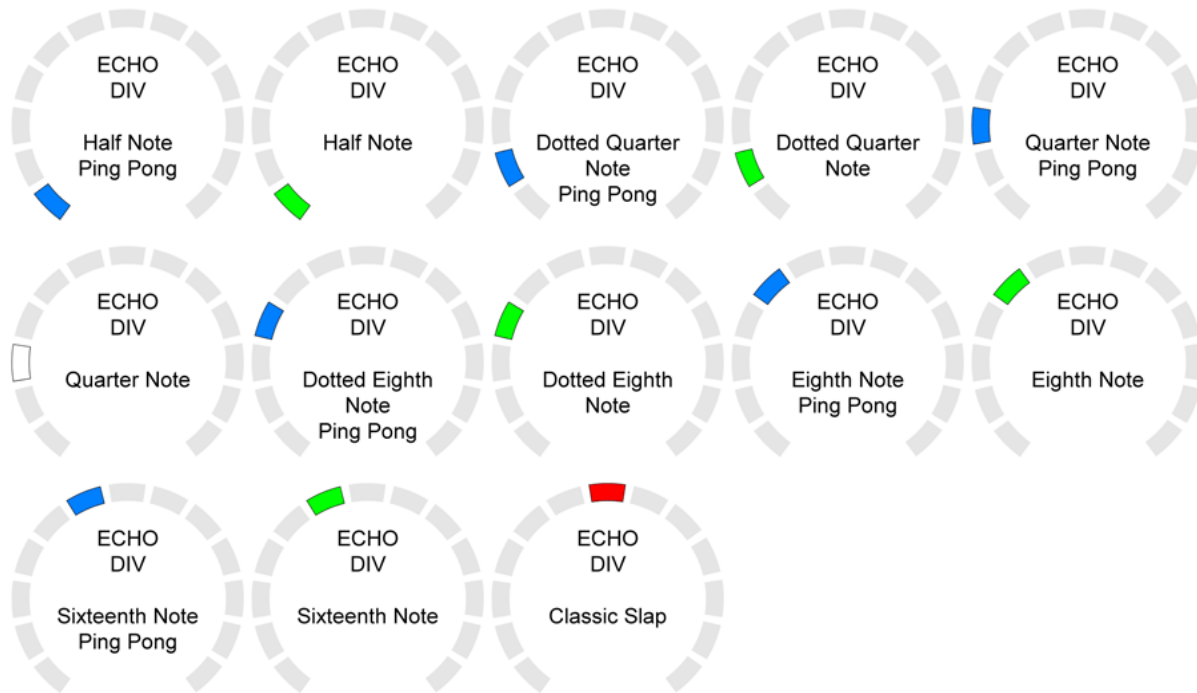

NOTE: As with other effect division parameters, a white LED indicates a straight quarter note division.

Echo Delay

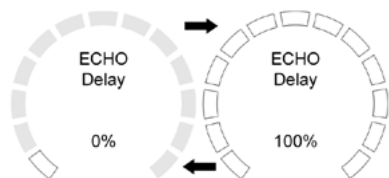

Echo Delay is a master parameter that simultaneously edits the delay's feedback and output level, where greater amounts will expand the volume and increase the number of delay echoes that you hear. At 100% the delay will feedback into echoes that never stop! Hold delay to edit.

Range: 0 to 100%

5.6 Filter



Applies to: LEAD Vocal
MIDI Voices

Anything that EQ's (equalizes), filters or distorts your voice falls into the Filter category. You can sound like you're on an old radio or distort your voice for an edgy attack. Be careful with Megaphone effects when you've got a loud PA. We need to adjust EQ a lot to create these sounds, so they're a bit more prone to feedback than other effects. Hold style to select different styles.

Filter Style: LPF/HPF

The first filter style is different from the rest: LPF/HPF is a **LowPass/HighPass** filter combination designed for shaping and sweeping musical audio. It also sounds great on rhythm tracks and noise.



Applies to: LEAD Vocal
MIDI Voices
LOOPER Drums & Audio

Filter Mod (LPF/HPF)

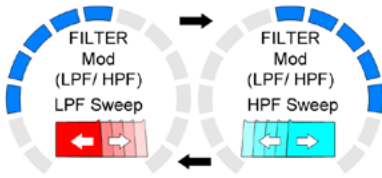

When the **LPF/HPF** Style is active, **Filter Mod** controls the cutoff frequency of either the LowPass or HighPass filter (LPF and HPF).

Range: 0 to 100%

Filter Style: Transducer Styles

The remaining four Filter Styles are filter **transducer** effects that alter your signal to sound like it is coming through various-sized amps and enclosures. The LOOPER Drum sounds will not be affected.

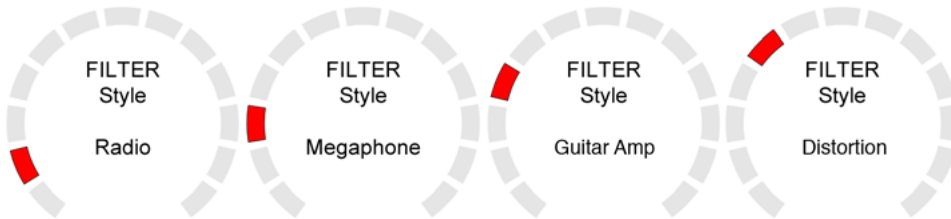

Try them out for yourself. They are fun and can be quite useful to mark a section of your music as 'different' from the rest of your arrangement.

Filter Mod (Transducer Styles)

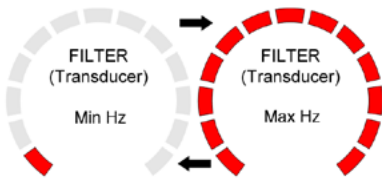

When a transducer style is selected, **Filter Mod** controls the transducer's cutoff frequency.

5.7 Tap (Tempo)



Applies to: Tempo

The Tap button's red LED flashes in time with the current tempo, with the down beat of each 4/4 measure flashing brighter than the remaining three beats.

When pressed, this light flashes in time with the Looper, Chopper, Stutter and Echo effects. Provided you have not previously recorded a loop, you can re-tap the tempo at any time to sync up with your current song. Keep in mind that you can tap at half-time or double-time for more flexible control.

NOTE: When the LOOPER is activated (glowing green), this means an audio loop has been recorded. You won't be able to tap a new tempo until the loop is erased. The LOOPER section (later in this manual) explains how you can record and erase drum and audio loops.

6. Looper

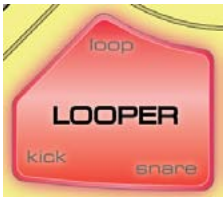

The Looper acts as both a drum machine and an audio looper.

Press the loop corner of the button to arm the looper. The button will now pulse to indicate that it is armed.

You can lay down a drum pattern immediately or press loop again to record an audio loop.

Drum Loop

Pressing the kick, snare and HEADPHONE (works as hi-hat) buttons will start recording the drum loop. Pressing loop again will set the loop point.

Audio loop

With the initial drum loop playing or the LOOPER button pulsing red, press loop to record the audio loop. The audio loop can be multiple lengths of the drum loop thus you can put down a single bar of drums then say 8 bars of audio. Pressing loop again sets the audio loop length.

Overdubbing

When the loop is playing, press loop again to overdub drums and audio.

Erasing Loop Components

Hold the SET button while pressing kick, snare, HEADPHONE or loop to erase the kick, snare, hi-hat or audio loop respectively. You can then re-record the component.

Stopping Loop Playback

Press the TAP button or double tap loop.

Start Loop Playback

Press loop.

Erase Loop Including Drums and Audio

Double tap and hold loop.

The LOOPER states are as follows:

Unlit	Looper off / loop cleared
Pulsing red	Armed for 1st loop recording
Solid red	Recording in progress
Pulsing green	Loop paused
Solid green	Loop playing

Once a loop has been recorded Perform-VE derives its tempo from the loop so that all effects are in sync. The derived tempo will be between 80 and 160 BPM (Beats Per Minute).

Drum Level

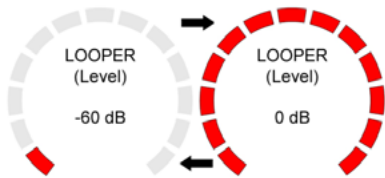

To adjust the drum loop level, hold the loop corner button while turning the Control Knob.

Range: -60 dB to 0 dB

Kick Drum Selection

Press the **kick** corner button to trigger the kick sample - you do this whether you are recording or not.

Hold the **kick** corner button while turning the Control Knob to select one of four kick drum samples:

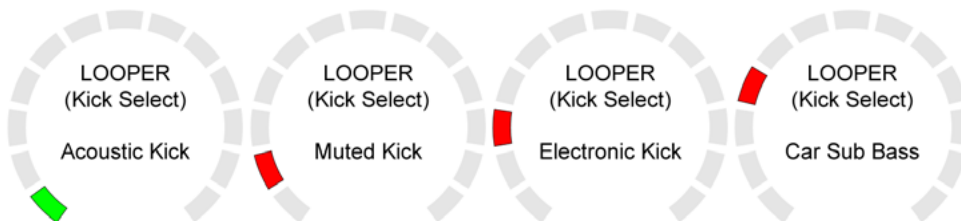

A green LED indicates an acoustic kick, while red LEDs indicate an electronic kick.

Snare Drum Selection

Press the **snare** corner button to trigger the snare sample. Just as with the kick, you can press snare at any time regardless of looper activity.

Hold the **snare** corner button while turning the Control Knob to select one of four snare drum samples:

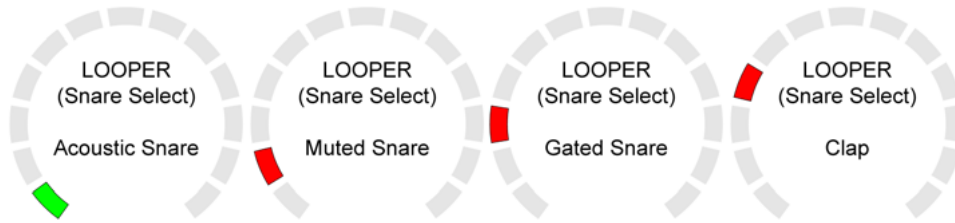

A green LED indicates an acoustic snare, while red LED options indicate an electronic sound.

NOTE: When you select a new snare sample, a matching hi-hat sample is also selected.

Looper: hi-hat



As was mentioned earlier, the hi-hat sample is triggered by pressing the HEADPHONE button when the LOOPER is active. This lets you record and overdub hi-hat events into your loop, and lets you play hi-hat along with the loop.

As long as the Looper button is lit or pulsing, the headphone button will trigger the hi-hat sample.

Looper Quantize

Perform-VE's looper can either quantize your drum events as they are recorded, or can leave their timing untouched. If Quantizing is enabled, drum events will be 'corrected' to the closest 16th note as they are recorded, resulting in a tighter more 'machine-like' groove.

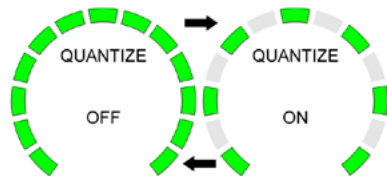

To enable/disable Looper Quantize, press SET and TAP to toggle between OFF and ON

Range: OFF, ON

Quantizing applies to external and internal clock setups, even when you lay down the very first pass of a drum loop under internal clock control. Once drum events have been recorded as quantized, disabling quantize will not restore their original timing.

If you find that the drum patterns you wish to record do not play back as intended, try erasing and re-recording them with the quantize set to the opposite value. Syncopated drum beats work best with quantize disabled, while robotic beats and quantization go great together.

External MIDI Clock

The alternative looper setup is to have MIDI clock coming in from an external instrument or a computer running audio workstation software. In this situation, Perform-VE is the slave to the external device and any loops you record will need to be made in time with the pulses shown on the TAP button.

One advantage of external clocking is that odd bar patterns (3, 5, 7 and up) can be recorded as loops, and playback will be perfectly synchronized with your external gear such as drum machines, arpeggiators and the like.

Backing Up Your Loops

The best way to preserve a loop is to record it with a DAW software package where it can be added to your clip library and used to build really complex arrangements.

The Looper Cookbook

Now you know where all the kitchen utensils are, here are some simple recipes for cooking up loops on Perform-VE.

How to make an initial drum loop:

- Arm loop by tapping the loop corner.
- Pressing kick, snare or the Headphone button (for hi hat) will automatically start the recording as you tap the drum pattern.
- Press loop corner again (on the beat) to set loop point and immediately begin playback.

How to add drums or audio to an existing loop:

- Press the loop corner to begin overdub recording while the drum loop plays, and either sing into the mic or press the drum trigger keys.
- Press loop corner again to set loop point and continue playback (audio loop can be multiples of the drum loop).

How to start with an audio loop (with no drum loop):

- Press loop to arm the recorder (pulses red).
- Press loop again to begin recording (solid red). Vocalize the audio that you want to loop.
- Press loop again to stop recording and set the loop point, playback begins immediately.

Stop Loop Playback:

- Press TAP or double tap loop.

Start Loop Playback:

- Press loop

Delete loop:

Double tap and hold loop corner.

7. Sample

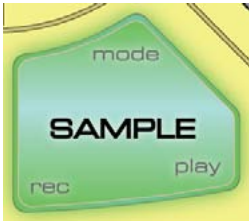

The SAMPLE performance effect records a **sample** of your input audio signal and processes it with TC-Helicon's **VSS** technology to create sample-based MIDI voices.

VSS (Vocal SampleSynthesis) allows you to record anything from bel canto to beatboxing, then play it back on the keyboard instantly at any pitch, with the tonal nuance of your performance well intact. SAMPLE works closely with MORPH, in that Morph styles and modes interact directly with sample playback.

- Hold rec while singing into a connected microphone to record audio for sample playback.
- Play a connected MIDI instrument for pitch-flattened sample playback.
- Press MODE to toggle from sample playback to MIDI notes operation.
- Press PLAY to play back the sample as recorded.

Sample Mode

The four sample modes control how the sample is played back in response to MIDI notes:



The four sample modes are combinations of staccato, legato, normal and looped playback characteristics.

- Re-trigger: Each new note triggers the sample from the start.
- Legato: Each new note synchronizes its playback to samples that are already playing.
- Looped: When MIDI notes are held down beyond the end of the sample, it will loop.

Sample yourself saying a short sentence and try the various modes out. Each has something exciting to offer your music making.

Once a sample has been recorded, it will stay in memory until replaced by a new recording, or until you turn off your Perform-VE.

Sample Management with the Perform-VE App

The Perform-VE App for iOS allows you to back up, manage and restore Perform-VE samples. Please check out the app for more details. Note: The Android version of the Perform-VE App does not support samples owing to OS limitations.

8. Presets

A preset is a “complete sound” created by a combination of effects.

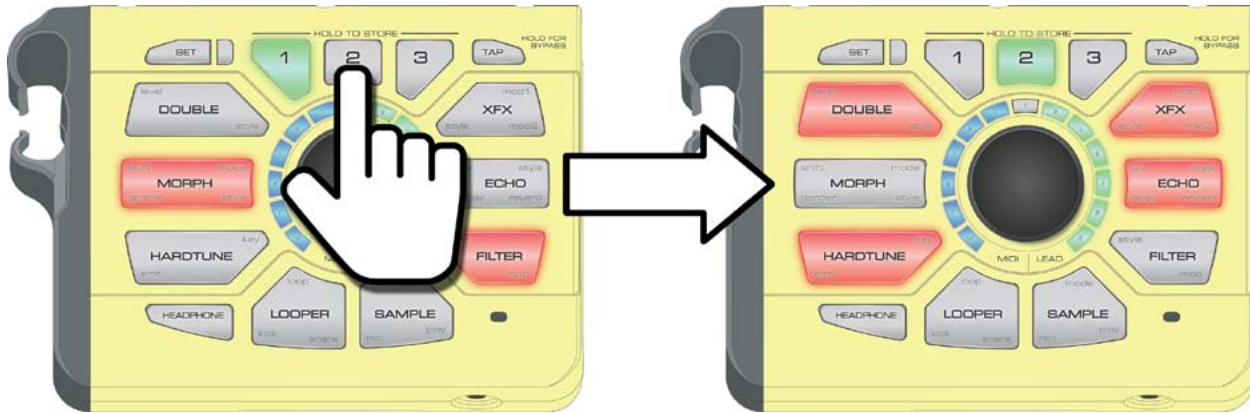

You'll notice that the active effects change between Preset 1 and Preset 2 in the image above. Presets can be configured however you like. The state (on/off), style, level and other editable parameters for each effect in a preset can also be different from preset to preset.

Saving Changes

To save your current settings as one of the three presets, press and hold preset button 1, 2, or 3 for one second. The preset button will flash briefly when storage is complete. You can now turn off your Perform-VE and your preset will be ready for you when you next power up and press a number button.

Preset Management with the Perform-VE App

The Perform-VE App for iOS and Android is available as a free download from each platform's respective app stores. This app allows you to back up, manage and restore all three of Perform-VE's onboard presets. Please check out the app for more details.

9. I/O Section

9.1 AUX Input



Perform-VE's AUX input allows you to connect a separate stereo audio source as a source of backing tracks – this could be a smartphone, pod device, music player, secondary laptop or any device connecting via a 1/8th inch stereo jack.

When you have a music player connected to the AUX input, incoming chord information will not be used to determine key/scale for HardTune's NaturalPlay detection.

You will hear the AUX input mixed with your Mic input (vocals). If the AUX is too loud or too quiet, use the volume control on the music player to create the appropriate mix with your vocals.

Aux to Main Out

Sometimes, you'd like to have a signal from the Aux input guide key/scale, but you don't want that Aux signal mixed into your main outputs. If you'd like to remove audio from Aux to the main out, simply press/hold the Headphone button while connecting your Aux (1/8") cable.

This parameter resets each time you unplug and re-plug the Aux cable, and when you power cycle the unit. Perform-VE doesn't save this parameter because it's not immediately obvious how you'd "toggle" things and we don't want to trap unsuspecting users like you in a mode you can't find a way out of.

As for Perform-VE's headphone output jack - the Aux in is always routed to it regardless of the **Aux to Main Out** setting.

9.2 Switch3/Switch6 (Pedal) In

When a Switch3 or Switch6 is connected (using the TRS cable that came in the S3/S6 box) you can control various aspects of Perform-VE remotely.

The default behavior for Switch3 is to change presets according to the numbers on Switch3.

Switch1 = Preset 1

Switch2 = Preset 2

Switch3 = Preset 3

You can reassign any of the Perform-VE buttons to be activated by a footswitch, with the exception of TRIM, +48V, Headphone Level, and Lock/Mute (TALK is assignable).

Press and hold the desired footswitch, then press the button on Perform-VE that you'd like the switch to control. Release both buttons.

Switch6 acts in the same manner as Switch3 but adds buttons 4, 5, and 6. The default controls for the extra buttons are:

Switch4 = Harmony

Switch5 = Reverb

Switch6 = Echo

9.3 USB Audio

Perform-VE has 5 input and 6 output channels for USB audio. A driver is required for both USB audio and MIDI use. It can be found and downloaded from tc-helicon.com/products/Perform-VE/support/

USB IN

CH 1 Backing Track L

CH 2 Backing Track R

CH 3 Dry vocal in

CH 4 Sample IN

CH 5 NaturalPlay IN

If no signal is transmitted to the product on USB audio channel 3, the product will use the Microphone IN for the voice input. So, you could use channels 1&2 to input stereo tracks from your DAW but sing into the product via your mic. Note that channel 1&2 input is NOT passed to the USB outputs, but IS passed to the Main analog outs. If you use a computer for backing tracks, they will be sent analog to the PA. Volume control for those tracks happens at the computer. When USB audio on channel 3 stops, the Set button will flash. Pressing the Set button at this time will change the voice input back to the Microphone input.

NaturalPlay IN is not connected to the audio output - it is used only for NaturalPlay chord input. This provides the option to have a "guide track" for NaturalPlay that the audience can't hear. It could be dry guitar chords or piano chords, with different voicings or placement in order to create your desired vocal output.

USB OUT

CH 1 L processed vocal, Keyboard/ Aux in (same as what is on main outputs, less the audio received on USB in

CH 2 R processed vocal, Keyboard/ Aux in (same as what is on main outputs, less the audio received on USB in 2

CH 3 Dry Voice input

CH 4 SAMPLE Out

CH 5 Aux L

CH 6 Aux R

9.4 RoomSense

Did you notice that little hole on the front of the unit? It's a microphone!

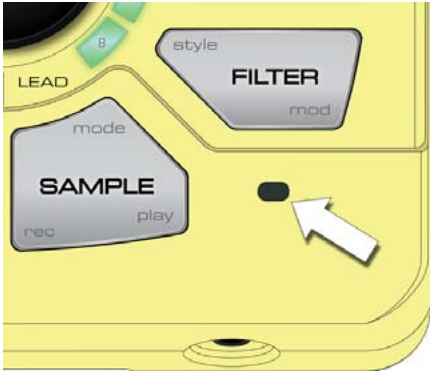

It's there for two reasons:

1. If you don't plug in a microphone and have headphones connected, you can sing into the onboard mic. It's a great way to practice with virtually no other equipment. If you're singing into the RoomSense mic, the Main Outputs will be muted to prevent feedback.
2. If you activate HardTune effects with the NP (Natural Play) key set, and you're not using MIDI, keyboard audio or an Aux music source to guide key/scale, the mic will listen for chords in the room (like a nearby guitar) and try to figure out key and scale from that! Pretty cool. RoomSense is the most unpredictable of the key/scale trackers, since the room dynamics and chord information are most easily obscured using this mode.

EN Appendix A: Effect Quick Reference Chart

Double	Style	<ol style="list-style-type: none"> 1. Unison 2. Octave Down 3. Octave Up 4. Octave Up/Down
Morph	Style	<ol style="list-style-type: none"> 1. Natural Shift 2. Warp Shift 3. to 11. Analog Synth Modeled Vocoder
	Mode	Green: Poly + release time Red: Mono + Portamento time
XFX	Style	1. Stutter Mod1: Rate Mod2: Level
		2. Mono Chopper Mod1: Rate Mod2: Depth
		3. Stereo Chopper Mod1: Rate Mod2: Depth
		4. Ring Mod Mod1: Rate Mod2: Depth
		5. Stereo Flanger Mod1: Rate Mod2: Depth
		6. Mono Flanger Mod1: Rate Mod2: Depth
		7. Side Chain Pumping Mod1: Threshold Mod 2: Release Time
Filter	Style	<ol style="list-style-type: none"> 1. LPF/HPF 2. Radio 3. Megaphone 4. Guitar Amp 5. Distortion
Sample	Mode	<ol style="list-style-type: none"> 1. Re-Trigger 2. Legato 3. Looped Re-Trigger 4. Looped Legato

Appendix B: MIDI Implementation

Perform-VE responds to Control Change (CC), Program Change (PC) and MIDI Tempo (not MIDI Clock) information.

MIDI PC Messages

The product's 3 presets correspond to Program Change: 0, 1, 2

MIDI CC List

Implemented Continuous Controller (CC) messages:

CC	Perform-VE Parameter	Range
1	Vibrato (Mod Wheel)	0-127
16	XFX Style	0-6 (See Style List)
17	DOUBLE Style	0-3 (See Style List)
18	FILTER Style	0-4 (See Style List)
19	HardTune Key	0-13 (See HardTune Key List)
20	HardTune Amount	0-127
21	XFX Mod 1	0-127
22	XFX Mod 2	0-127
23	MORPH Mode	0-25 (0-12: Poly Release), (13-25: Mono Portamento)
24	MORPH Style	0-10 (See Style List)
25	SAMPLE Mode	0-3 (See Style List)
26	Notes Voice Smoothing	0-127
27	ECHO (Delay) Div	0-12 (See Echo Div List)
28	ECHO (Reverb) Style	0-3 (See Style List)
41	Top Mix: LEAD Level	0-127 (Lead is set independent of MIDI via CC)
42	Top Mix: MIDI Level	0-127 (MIDI is set independent of LEAD via CC)
43	MORPH Shift	0-36-72 (maps to -36,0,+36 semitones)
44	Morph Gender	0-127
45	DOUBLE Level	0-127
46	Delay	0-127
47	Reverb	0-127
48	Filter Mod	0-127
51	DOUBLE Enable	0-63: OFF, 64-127: ON
52	MORPH Enable	0-63: OFF, 64-127: ON
53	HARDTUNE Enable	0-63: OFF, 64-127: ON
54	XFX Enable	0-63: OFF, 64-127: ON
55	ECHO Enable	0-63: OFF, 64-127: ON
56	FILTER Enable	0-63: OFF, 64-127: ON
58	SAMPLE Record Switch	0-63: OFF, 64-127: ON
59	SAMPLE Play Switch	0-63: OFF, 64-127: ON
64	Sustain Pedal	0-63: OFF, 64-127: ON
72	Envelope Release	0-127
73	Envelope Attack	0-127
80	SAMPLE Enable	0-63: OFF, 64-127: ON
81	LOOPER Kick Trigger	0: OFF, 1-127: ON - All positive values trigger.
82	LOOPER Snare Trigger	0: OFF, 1-127: ON - All positive values trigger.
83	LOOPER Hi-Hat Trigger	0: OFF, 1-127: ON - All positive values trigger.

RPN/NRPN Implementation

RPN 0: Pitch Bend Sensitivity. This is a standard way to change pitch bend range.

MIDI Tempo

Perform-VE responds to incoming MIDI tempo and will adjust system Tap Tempo accordingly.

Split Point and Transpose

When controlling Morph Voices via MIDI notes, it is sometimes desirable to have one section of the keyboard designated to sending that control information. It could be the area that your left hand is, to play chords of harmonies.

In order to designate an area of the keyboard to respond to, a Split Point is set. Any notes, either above or below the split point, are deemed useable by the system. Notes outside the range are rejected.

To set the Split Point, hold the SET button and press the note on your keyboard that you want to act as the split note. Then, to choose a split ABOVE that note, release the split note and press a note ONE SEMITONE ABOVE your split note. To choose a split BELOW, release the split note and press a note ONE SEMITONE BELOW your split note.

This creates a split, above or below, with no transposition. In order to set a split point AND transpose the incoming MIDI notes, you will choose a different note in place of the ABOVE/BELOW notes mentioned above.

This may seem a bit confusing, but does allow you to make both a split above/below point AND transpose either up or down. Here's a chart and some explanation.

Second Note	Split	Transpose X To
X+6	Above	X5
...	Above	...
X+2	Above	X1
X+1	Above	X (no transpose)
X+0	---	--
X-1	Below	X (no transpose)
X-2	Below	X6
...	Below	...
X-6	Below	X2

In the chart above, "X" is the split note, the point at which you want to split the keyboard, as explained previously.

To facilitate things like "split above, but transpose down" we need to have settings both above and below your split point. That's where the chart comes in.

For example, if you want to split ABOVE middle C, typically known as C4, but transpose DOWN so that C4 is actually C2, you'd do the following:

1. Hold SET
2. Press middle C (C4)
3. Press the note 6 SEMITONES DOWN from middle C (F#)

If you want to split BELOW middle C (C4) and transpose up so that C4 is C6, you'd:

1. Hold SET
2. Press middle C (C4)
3. Press the note 2 SEMITONES DOWN from middle C (A#)

You may need to experiment a bit to figure this out, but it does give you the ability to set your split point, split direction and transposition very quickly.

Appendix C: General

Factory Reset

To reset the unit back to factory settings, press and hold the DOUBLE and HARDTUNE buttons while powering up.

Support

If you've read through this manual and still need a little help, you can contact us via our support portal and forums

<http://support.tc-helicon.com>

