

Kramer Electronics, Ltd.

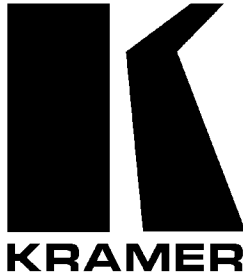

USER MANUAL

Model:

VS-42HC

4x2 Home Entertainment Matrix Switcher

Contents

1	Introduction	1
2	Getting Started	1
3	Overview	2
3.1	Terminology Used in this User Manual	3
4	Your VS-42HC 4x2 Home Entertainment Matrix Switcher	3
5	Installing the VS-42HC on a Rack	7
6	Connecting the VS-42HC	8
6.1	Connecting the VS-42HC Rear Panel	8
6.2	Connecting the Audio Signals	10
6.3	Setting the Dipswitches	11
6.3.1	Setting the Machine #	11
6.3.2	Setting the IN 2 Audio Signal	12
7	Controlling the VS-42HC	12
7.1	Controlling via RS-232 (for example, using a PC)	12
7.2	Controlling via RS-485	13
7.2.1	Configure the Dipswitches	13
7.3	Controlling the VS-42HC via the ETHERNET Port	15
7.3.1	Connecting the ETHERNET Port directly to a PC (Crossover Cable)	15
7.3.2	Connecting the ETHERNET Port via a Network Hub (Straight-Through Cable)	17
7.4	Configuring the Ethernet Port	17
7.4.1	Setting a Virtual Port	19
7.4.2	Setting an Ethernet Connection	20
8	Operating the VS-42HC	21
8.1	Switching OUT-IN Combinations	21
8.2	Setting and Adjusting the Audio Delay Time	21
8.3	Locking the Front Panel	23
9	Flash Memory Upgrade	24
9.1	Switcher Flash Memory Upgrade	24
9.1.1	Downloading from the Internet	24
9.1.2	Connecting the PC to the RS-232 Port	24
9.1.3	Upgrading Firmware	25
9.2	Ethernet Flash Memory Upgrade	29
9.2.1	Downloading from the Internet	29
9.2.2	Connecting the PC to the RS-232 Port	29
9.2.3	Upgrading Firmware	30
10	Technical Specifications	31
11	Table of Hex Codes for Serial Communication (RS-232/RS-485 Protocol)	32
11.1	Hex Codes for Switching	32
11.2	VS-44HC Hex Codes for Setting the Audio Delay Time	32



Figures

Figure 1: VS-42HC 4x2 Home Entertainment Matrix Switcher	4
Figure 2: VS-42HC Underside View	6
Figure 3: Connecting the VS-42HC 4x2 Home Entertainment Matrix Switcher	9
Figure 4: Connecting the VS-42HC Digital Audio Signals	10
Figure 5: Dipswitch Settings	11
Figure 6: Connecting a PC without using a Null-modem Adapter	12
Figure 7: Cascading Individual Units in a Control Configuration via RS-485	14
Figure 8: RJ-45 PINOUT	15
Figure 9: Local Area Connection Properties Window	16
Figure 10: Internet Protocol (TCP/IP) Properties Window	16
Figure 11: The Ethernet Configuration Manager Window	18
Figure 12: The Virtual Serial Port Manager Window	19
Figure 13: The Virtual Serial Port Properties Window	19
Figure 14: The Virtual Serial Port Properties Window (COM 3 and COM 4)	20
Figure 15: The Port Window – Selecting a Virtual Serial Port	20
Figure 16: The Port Window – Selecting a Remote Connection	20
Figure 17: Splash Screen	25
Figure 18: Atmel – Flip Window	25
Figure 19: Device Selection Window	26
Figure 20: Device Selection window	26
Figure 21: Loading the Hex	27
Figure 22: RS-232 Window	27
Figure 23: Atmel – Flip Window (Connected)	28
Figure 24: Atmel – Flip Window (Operation Completed)	28
Figure 25: The KFR-Programmer Window	30

Tables

Table 1: Terminology Used in this User Manual	3
Table 2: Front Panel VS-42HC 4x2 Home Entertainment Matrix Switcher Features	5
Table 3: Rear Panel VS-42HC 4x2 Home Entertainment Matrix Switcher Features	5
Table 4: Dipswitch Settings Description	11
Table 5: Machine # Dipswitch Settings	11
Table 6: Digital Audio IN 2 Signal Setting	12
Table 7: Crossover Cable RJ-45 PINOUT	15
Table 8: Straight-through Cable RJ-45 PINOUT	17
Table 9: Ethernet Configuration Manager Window Functionality	18
Table 10: Maximum Delay Time according to Sampling Rate	22
Table 11: DELAY Button Response	22
Table 12: Technical Specifications of the VS-42HC	31
Table 13: VS-42HC Hex Codes for Switching via RS-232/RS-485	32
Table 14: VS-42HC Hex Codes for Setting the Audio Delay Time	33
Table 15: VS-42HC Hex Codes for increasing the Audio Delay Time	33

1 Introduction

Welcome to Kramer Electronics (since 1981): a world of unique, creative and affordable solutions to the infinite range of problems that confront the video, audio and presentation professional on a daily basis. In recent years, we have redesigned and upgraded most of our line, making the best even better! Our 500-plus different models now appear in 8 Groups¹, which are clearly defined by function.

Congratulations on purchasing your **VS-42HC 4x2 Home Entertainment Matrix Switcher**, which is ideal for the following typical applications:

- Professional audio/video studios
- Home cinema DVD applications

The package includes the following items:

- **VS-42HC 4x2 Home Entertainment Matrix Switcher**
- Power cord
- Null-modem adapter
- Windows®-based Kramer control software²
- Windows®-based Ethernet Configuration Manager and Virtual Serial Port Manager
- Infra-red remote control transmitter (including the required batteries and a separate user manual³)
- This user manual³

2 Getting Started

We recommend that you:

- Unpack the equipment carefully and save the original box and packaging materials for possible future shipment
- Review the contents of this user manual
- Use Kramer high performance high resolution cables⁴

1 GROUP 1: Distribution Amplifiers; GROUP 2: Video and Audio Switchers, Matrix Switchers and Controllers; GROUP 3: Video, Audio, VGA/XGA Processors; GROUP 4: Interfaces and Sync Processors; GROUP 5: Twisted Pair Interfaces; GROUP 6: Accessories and Rack Adapters; GROUP 7: Scan Converters and Scalers; and GROUP 8: Cables and Connectors

2 Downloadable from our Web site at <http://www.kramerelectronics.com>

3 Download up-to-date Kramer user manuals from our Web site: <http://www.kramerelectronics.com>

4 The complete list of Kramer cables is on our Web site at <http://www.kramerelectronics.com>

3 Overview

The **VS-42HC** is a true 4x2 matrix switcher for YUV (Y, Pb/Cb, Pr/Cr) component video and digital audio (S/PDIF) signals. The high quality **VS-42HC** lets you simultaneously route any of the 4 inputs to either one or both of the outputs. The component video and S/PDIF input and output signals are on RCA connectors, and the S/PDIF channel 2 is also available on optical (TOSLINK¹) input/output connectors.

The **VS-42HC 4x2 Home Entertainment Matrix Switcher** features:

- A video bandwidth of 200MHz that ensures transparent performance
- An audio channel sampling rate of up to 192kHz, including multi-channel audio (suitable for multi-channel applications, like AC3)
- A built-in digital audio delay time, which corrects lip sync errors so that the audio delay will match the video delay
- DC coupled video inputs and outputs
- A LOCK button to prevent tampering with the front panel

Control the **VS-42HC** using the front panel buttons, or remotely via:

- RS-232 and RS-485 serial commands transmitted by a touch screen system, PC, or other serial controller
- The Kramer infra-red remote control transmitter
- The ETHERNET

To achieve the best performance:

- Connect only good quality connection cables, thus avoiding interference, deterioration in signal quality due to poor matching, and elevated noise levels (often associated with low quality cables)
- Avoid interference from neighboring electrical appliances that may adversely influence signal quality and position your Kramer **VS-42HC** away from moisture, excessive sunlight and dust

¹ A digital audio optical connector found on many consumer audio devices

3.1 Terminology Used in this User Manual

Table 1 defines some terms that are used in this user manual:

Table 1: Terminology Used in this User Manual

Term	Definition
802.3	The standard specification for ETHERNET that is maintained by the Institute of Electrical and Electronics Engineers (IEEE).
Dynamic Host Configuration Protocol (DHCP)	Allows the network administrator to distribute IP addresses from a central point and automatically send a new IP address when an Ethernet point is plugged into a different network location.
Gateway	A network position serving as an entry to another network. On the Internet, a node or stopping point can be either a gateway node or a host (end-point) node.
IP Address	A 32-binary digit number that identifies each sender or receiver (within a network via a particular server or workstation) of data (HTML pages or e-mails) that is sent in packets across the Internet. Every device connected to an IP network must have a unique IP address. This address is used to reference the specific unit.
Local Area Network (LAN)	Computers sharing a common communications line or wireless link, which often share a server within a defined geographic area.
Media Access Control (MAC) Address	A computer's unique hardware number (or address) in a LAN or other network. On an Ethernet LAN, the (MAC) address is identical to the Ethernet address.
Transmission Control Protocol/Internet Protocol (TCP/IP)	The basic communication language or protocol of the Internet that breaks the message into appropriately sized packets for the network, and can be used as a communications protocol in an intranet or an extranet.

4 Your VS-42HC 4x2 Home Entertainment Matrix Switcher

Figure 1, Table 2 and Table 3 define the **VS-42HC 4x2 Home Entertainment Matrix Switcher**:

Your VS-42HC 4x2 Home Entertainment Matrix Switcher

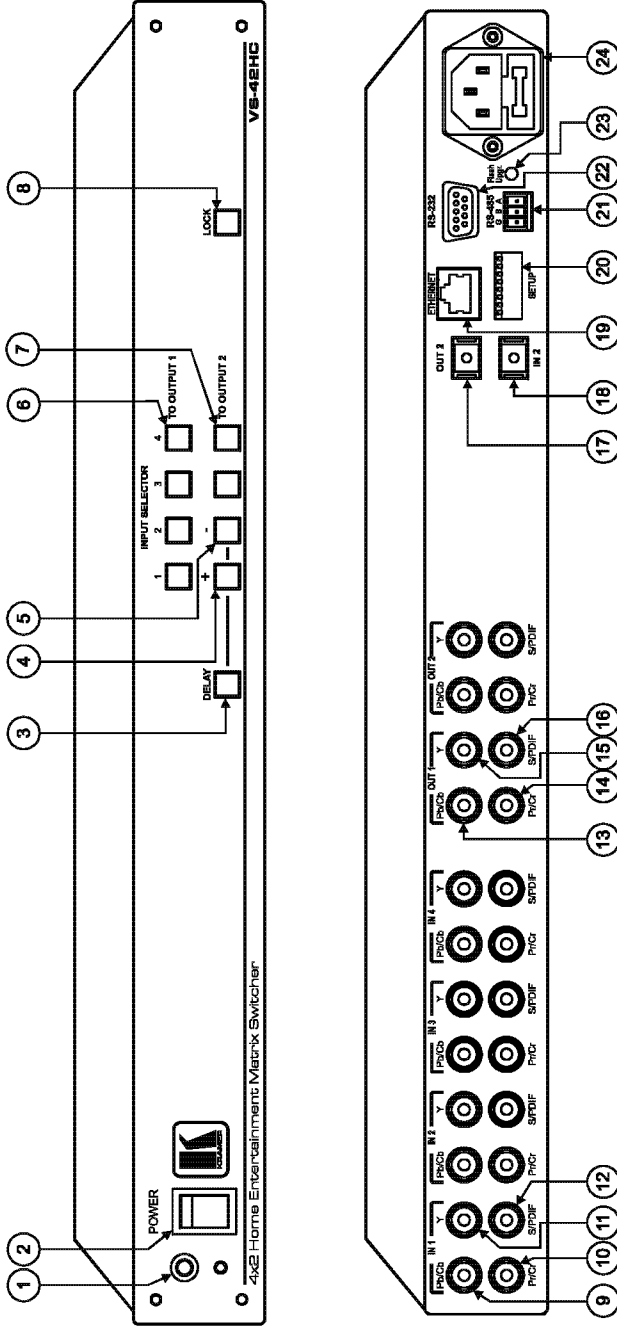

Figure 1: VS-42HC 4x2 Home Entertainment Matrix Switcher

Table 2: Front Panel VS-42HC 4x2 Home Entertainment Matrix Switcher Features

#	Feature	Function
1	IR Receiver	The red LED is illuminated when receiving signals from the infra-red remote control transmitter
2	POWER Switch	Illuminated switch for turning the unit ON or OFF
3	DELAY Button	Toggles the output 2 delay feature between: On – activate the delay Set – set the delay time Off – turn off the delay (see section 8.2)
4	+ Button	Press to increase the audio delay time (and also item 7 in this table)
5	- Button	Press to decrease the audio delay time (and also item 7 in this table)
6	INPUT SELECTOR	TO OUTPUT 1 Buttons
7		TO OUTPUT 2 Buttons
8	LOCK Button	Disengages/engages the front panel switches

Table 3: Rear Panel VS-42HC 4x2 Home Entertainment Matrix Switcher Features

#	Feature	Function
9	IN Component	Pb/Cb RCA Connectors
10		Pr/Cr RCA Connectors
11		YRCA Connectors
12	S/PDIF	Connect to the digital audio source (from IN 1 to IN 4)
13	OUT Component	Pb/Cb RCA Connectors
14		Pr/Cr RCA Connectors
15		YRCA Connectors
16	S/PDIF	Connect to the digital audio acceptor (OUT 1 and OUT 2)
17	OUT 2 TOSLINK Connector	Connect to the digital audio acceptor ¹
18	IN 2 TOSLINK Connector	Connect to the digital audio source ¹
19	ETHERNET Connector	Connects to the PC or other Serial Controller through computer networking LAN
20	SETUP Dipswitches	Dipswitches for setup of the unit (1, 2, 3 and 4 are for setting the machine #; 6 and 7 are for selecting the digital audio source and 8 is for RS 485 Termination)
21	RS-485 Terminal Block Port	Pins B (-) and A (+) are for RS-485 connection. If shielded cabling is used for RS-485, then the shield may be connected to Pin G is desired
22	RS-232 DB 9F Port	Connects to the PC or the Remote Controller
23	FLASH Upgr. Button	Push in ² for "Program" to upgrade the switcher microcontroller to the latest Kramer firmware (see section 9.1.2), or release (the factory default) for Normal operation
24	Power Connector with Fuse	AC connector enabling power supply to the unit

¹ Use an optical cable, such as Sony's POC-15A (not included in the package)

² Using a screwdriver if required

The VS-42HC underside is illustrated in Figure 2:

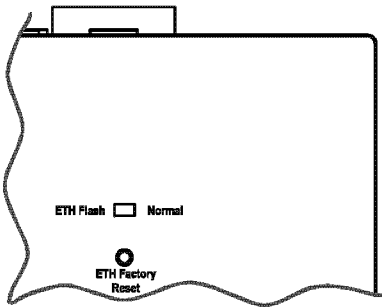

Feature	Function
ETH Flash – Normal Switch	Set to Normal for normal operation; Set to ETH Flash to upgrade firmware (see section 9.2)
ETH Factory Reset Button	Press to reset to factory default definitions ¹ : IP Address: 192.168.1.39 Mask: 255.255.255.0 Gateway: 192.168.1.1

Figure 2: VS-42HC Underside View

¹ Turn the machine OFF using the power switch and then turn it ON while pressing the ETH Factory Reset button. The unit will power up and load its memory with the factory default definitions

5 Installing the VS-42HC on a Rack

This section describes what to do before installing on a rack and how to rack mount.

Before Installing on a Rack

Before installing on a rack, be sure that the environment is within the recommended range:	
Operating temperature range	+5 to +45 Deg. Centigrade
Operating humidity range	5 to 65 % RHL, non-condensing
Storage temperature range	-20 to +70 Deg. Centigrade
Storage humidity range	5 to 95% RHL, non-condensing



CAUTION!!

When installing on a 19" rack, avoid hazards by taking care that:

- 1 It is located within the recommended environmental conditions, as the operating ambient temperature of a closed or multi unit rack assembly may exceed the room ambient temperature.
- 2 Once rack mounted, enough air will still flow around the machine.
- 3 The machine is placed straight in the correct horizontal position.
- 4 You do not overload the circuit(s). When connecting the machine to the supply circuit, overloading the circuits might have a detrimental effect on overcurrent protection and supply wiring. Refer to the appropriate nameplate ratings for information. For example, for fuse replacement, see the value printed on the product label.
- 5 The machine is earthed (grounded) in a reliable way and is connected only to an electricity socket with grounding. Pay particular attention to supply connections other than direct connections to the branch circuit (for example, the use of power strips), and that you use only the power cord that is supplied with the machine.

How to Rack Mount

To rack-mount the machine:

- 1 Attach both ear brackets to the machine. To do so, remove the screws from each side of the machine (3 on each side), and replace those screws through the ear brackets.

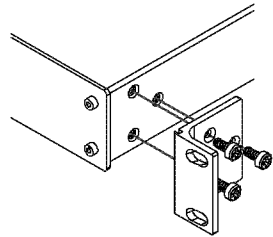

- 2 Place the ears of the machine against the rack rails, and insert the proper screws (not provided) through each of the four holes in the rack ears.

Note that:

- In some models, the front panel may feature built-in rack ears
- Detachable rack ears can be removed for desktop use
- Always mount the machine in the rack before you attach any cables or connect the machine to the power
- If you are using a Kramer rack adapter kit (for a machine that is not 19"), see the Rack Adapters user manual for installation instructions (you can download it at: <http://www.kramerelectronics.com>)

6 Connecting the VS-42HC

This section describes how to connect the **VS-42HC**. In particular, how to:

- Connect the **VS-42HC** rear panel (see section 6.1)
- Connect the audio signals (see section 6.2)
- Set the dipswitches (see section 6.3)

6.1 Connecting the VS-42HC Rear Panel

To connect the **VS-42HC**, as the example in Figure 3 illustrates, do the following¹:

1. Connect up to four component video sources² (for example, four DVD players) to the three IN RCA connectors Y, Pb/Cb and Pr/Cr (from IN 1 to IN 4) and connect the corresponding digital audio sources to the S/PDIF³ RCA connectors (see section 6.2).
2. Connect⁴ the three OUT 1 RCA connectors Y, Pb/Cb and Pr/Cr to the video acceptor (for example, a plasma display) and connect the corresponding OUT 1 S/PDIF RCA connector (see section 6.2) to the digital audio acceptor (for example, an AV receiver).
3. Connect the three OUT 2 RCA connectors Y, Pb/Cb and Pr/Cr to the video acceptor (for example, a plasma display) and connect the corresponding OUT 2 S/PDIF RCA connector and OUT 2 (TOSLINK) connector (see section 6.2) to the digital audio acceptor (for example, the audio connector on the digital display).
4. Set the dipswitches (see section 6.3).
5. If required, connect a PC and/or controller to the RS-232 port (see section 7.1) and/or the RS-485 port (see section 7.2) and/or the ETHERNET port (see section 7.3).
6. Connect the power cord⁵.

1 Switch OFF the power on each device before connecting it to your VS-42HC. After connecting your VS-42HC, switch on its power and then switch on the power on each device. DO NOT push in the rear panel Flash Program "Flash Upgr." button (see Table 3) and DO NOT switch the ETH Flash switch. These are only used for upgrading to the latest Kramer firmware (see section 9)

2 Although in this example four inputs are connected, you can connect less inputs

3 Or TOSLINK connector for IN 2

4 You do not need to connect both outputs

5 We recommend that you use only the power cord that is supplied with this machine

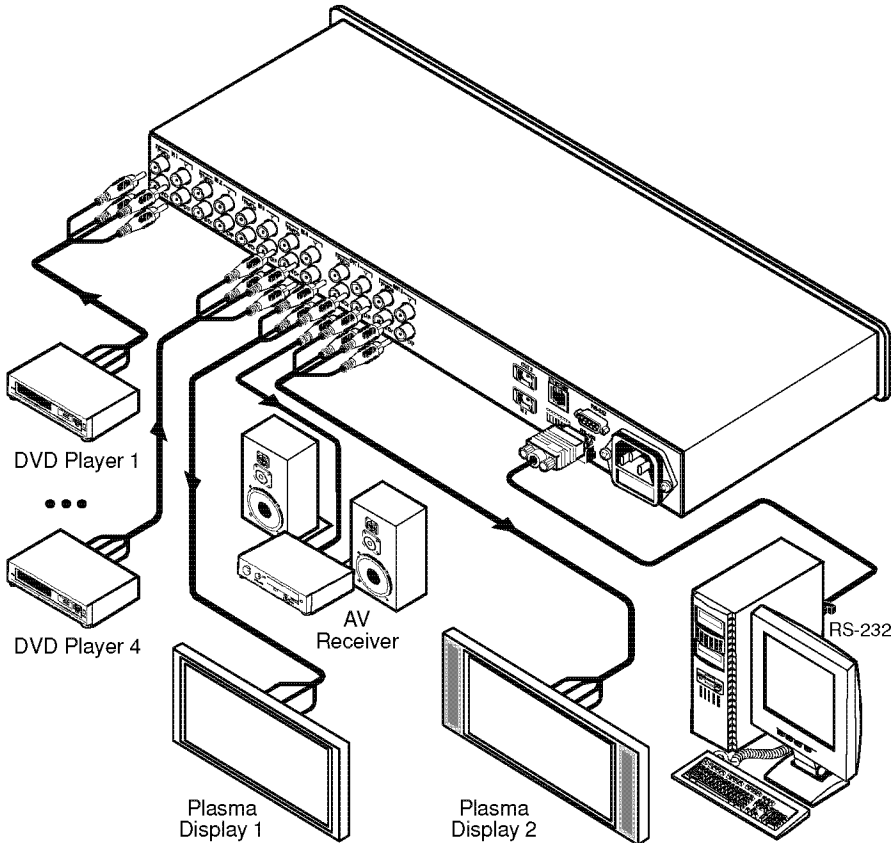

Figure 3: Connecting the VS-42HC 4x2 Home Entertainment Matrix Switcher

6.2 Connecting the Audio Signals

The **VS-42HC 4x2 Home Entertainment Matrix Switcher** inputs and outputs digital audio signals in the following formats:

- 4 S/PDIF inputs and 2 S/PDIF outputs on RCA connectors (from IN 1 to IN 4, and from OUT 1 to OUT 2, respectively)
- 1 TOSLINK input and 1 TOSLINK output for IN 2 and OUT 2

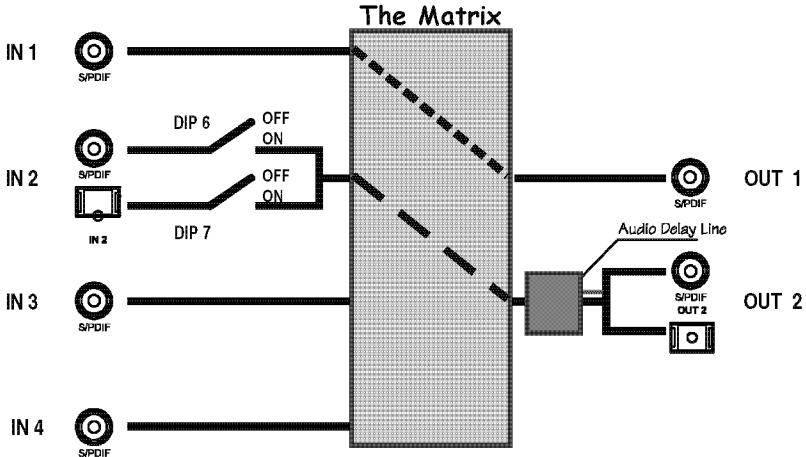

Figure 4: Connecting the VS-42HC Digital Audio Signals

In the example illustrated in Figure 4, IN 1 is switched to OUT 1; IN 3 and IN 4 are not connected.

The IN 2 digital audio signal can be routed either via the IN 2 S/PDIF connector, or the IN 2 TOSLINK connector, depending on the setup of dipswitches 6 and 7 (see section 6.3.2):

- To select the S/PDIF connector, set DIP 6 ON
- To select the TOSLINK connector, set DIP 7 ON

The digital audio signal on channel 2 is outputted simultaneously to both the S/PDIF and TOSLINK OUT 2 connectors.

To set the audio delay time, see section 8.2.

6.3 Setting the Dipswitches

Figure 5 illustrates the factory default dipswitches:

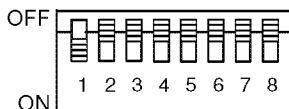

SETUP

Figure 5: Dipswitch Settings

Table 4: Dipswitch Settings Description

DIPS	Function	Description
1, 2, 3, 4	Machine #	Set the machine # (see section 6.3.1)
5	Reserved	OFF
6	S/PDIF	ON for IN 2 S/PDIF digital audio signal; OFF when TOSLINK is selected (see section 6.3.2) ¹
7	Optic	ON for IN 2 TOSLINK digital audio signal; OFF when S/PDIF is selected (see section 6.3.2) ¹
8	RS-485 Termination	ON for RS-485 Line Termination with 120Ω; OFF for no RS-485 Line Termination

6.3.1 Setting the Machine

To control a unit via RS-232 or RS-485, each unit has to be identified via its unique MACHINE #. Set the machine #² on a VS-42HC unit via dipswitches 1, 2, 3 and 4, according to Table 5.

Table 5: Machine # Dipswitch Settings

MACHINE #	DIPSWITCH			
	1	2	3	4
1	ON	OFF	OFF	OFF
2	OFF	ON	OFF	OFF
3	ON	ON	OFF	OFF
4	OFF	OFF	ON	OFF
5	ON	OFF	ON	OFF
6	OFF	ON	ON	OFF
7	ON	ON	ON	OFF
8	OFF	OFF	OFF	ON

MACHINE #	DIPSWITCH			
	1	2	3	4
9	ON	OFF	OFF	ON
10	OFF	ON	OFF	ON
11	ON	ON	OFF	ON
12	OFF	OFF	ON	ON
13	ON	OFF	ON	ON
14	OFF	ON	ON	ON
15	ON	ON	ON	ON

When connecting more than one VS-42HC unit, set a different machine # on each unit. You do not have to number the units in the sequence as they connect to the PC, but it is essential that each unit is assigned a unique machine number.

¹ Do not set both DIP 6 and DIP 7 ON

² When using a single unit, set the unit to MACHINE # 1

6.3.2 Setting the IN 2 Audio Signal

You can set the IN 2 digital audio signal to either an S/PDIF digital audio signal or a TOSLINK optical digital audio signal, as Table 6 defines¹.

Table 6: Digital Audio IN 2 Signal Setting

IN 2 Digital Audio Signal	DIPSWITCH	
	6	7
S/PDIF	ON	OFF
TOSLINK	OFF	ON
None	OFF	OFF

7 Controlling the VS-42HC

You can control the **VS-42HC** via:

- RS-232 (see section 7.1)
- RS-485 (see section 7.2)
- The Ethernet (see section 7.3)
- The IR remote control transmitter (see the separate user manual)

7.1 Controlling via RS-232 (for example, using a PC)

To connect a PC to the **VS-42HC** unit, using the Null-modem adapter provided *with* the machine (recommended):

- Connect the RS-232 DB9 rear panel port on the Master **VS-42HC** unit to the Null-modem adapter and connect the Null-modem adapter with a 9-wire flat cable to the RS-232 DB9 port on your PC

To connect a PC to the **VS-42HC** unit, *without* using a Null-modem adapter:

- Connect the RS-232 DB9 port on your PC to the RS-232 DB9 rear panel port on the Master **VS-42HC** unit, as Figure 6 illustrates

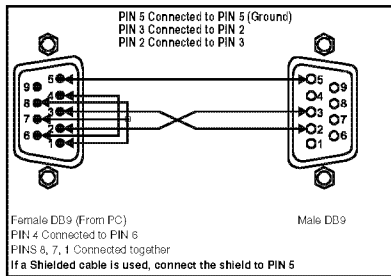

Figure 6: Connecting a PC without using a Null-modem Adapter

¹ You cannot set both DIP 6 and DIP 7 ON

7.2 Controlling via RS-485

You can control up to 15 **VS-42HC** units via an RS-485 controller, for example, a PC (equipped with an RS-485 interface) or a Master Programmable Remote Control system such as the Kramer **RC-3000**¹.

To connect an **RC-3000** to a **VS-42HC** unit (see Figure 7), connect the RS-485 terminal block port on the **RC-3000** to the RS-485 port on the **VS-42HC** unit, as follows:

1. Connect the “A” (+) PIN on the RS-485 rear panel port of the **RC-3000** to the “A” (+) PIN on the RS-485 rear panel port of the **VS-42HC** unit
2. Connect the “B” (-) PIN on the RS-485 rear panel port of the **RC-3000** to the “B” (-) PIN on the RS-485 rear panel port of the **VS-42HC** unit
3. If shielded twisted pair cable is used, the shield may be connected to the “G” (Ground) PIN on one of the units (for example, on the **RC-3000**)

To cascade up to 15 individual **VS-42HC** units, via RS-485, as illustrated in Figure 7, do the following:

1. Connect the component video sources and acceptors, as well as the appropriate digital audio sources and acceptors, as section 6.1 describes.
2. Connect the RS-485 terminal block port on the first **VS-42HC** unit to the RS-485 port on the second **VS-42HC** unit and so on, connecting all the RS-485 ports.
3. Configure the dipswitches (see section 7.2.1).

7.2.1 Configure the Dipswitches

Set the dipswitches, as section 6.3 describes:

- Assign a unique machine #² (from 1 to 15) for each **VS-42HC** unit, according to Table 5
- Set DIP 8 ON on the **VS-42HC** unit located at the end of the line (terminating the RS-485 line at 120Ω).
Set DIP 8 OFF on the other **VS-42HC** units
- Set DIP 5 OFF on all **VS-42HC** units
- Set DIP 6 and DIP 7 according to the IN 2 digital audio input signal (Table 6)

¹ Previously known as the VS-3000

² In any order

Controlling the VS-42HC

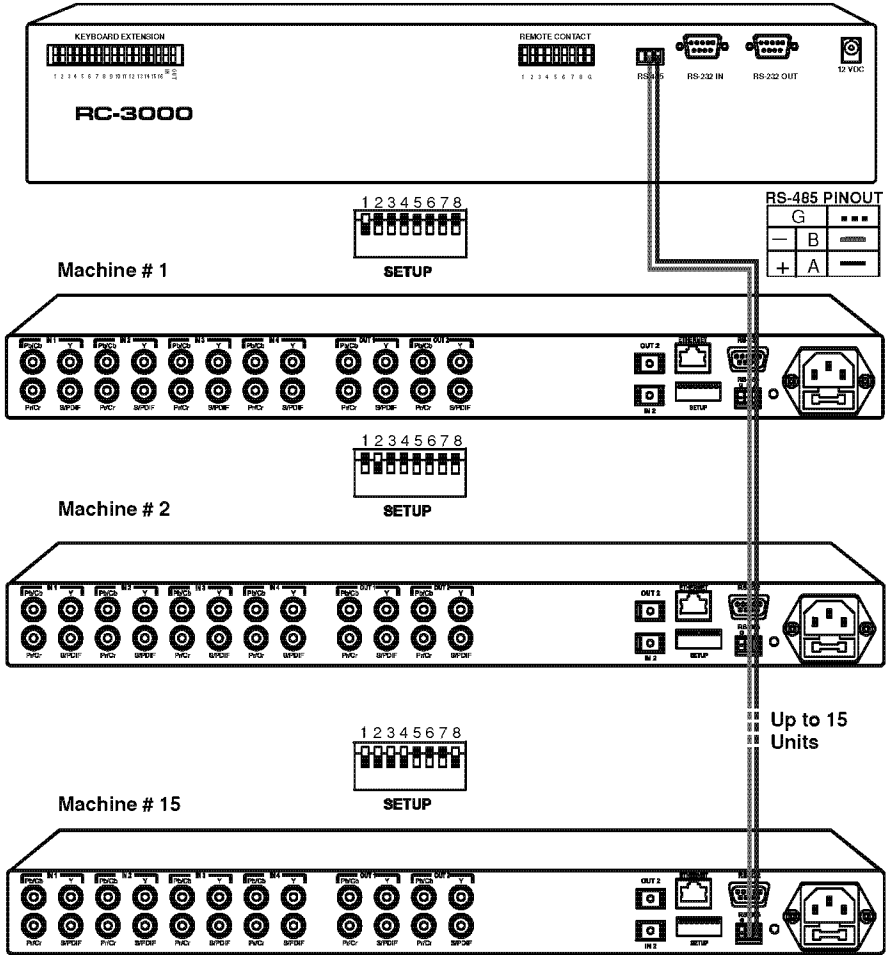

Figure 7: Cascading Individual Units in a Control Configuration via RS-485

7.3 Controlling the VS-42HC via the ETHERNET Port

You can connect the **VS-42HC** via the Ethernet, using a crossover cable (see section 7.3.1) for direct connection to the PC or a straight through cable (see section 7.3.2) for connection via a network hub or network router.

7.3.1 Connecting the ETHERNET Port directly to a PC (Crossover Cable)

You can connect the Ethernet port of the **VS-42HC** to the Ethernet port on your PC, via a crossover cable with RJ-45 connectors, as Table 7 and Figure 8 define.

Figure 8: RJ-45 PINOUT

Table 7: Crossover Cable RJ-45 PINOUT

EIA /TIA 568A Side 1		EIA /TIA 568B Side 2	
PIN	Wire Color	PIN	Wire Color
1	White-orange	1	White-green
2	Orange	2	Green
3	White-green	3	White-orange
4	Blue	4	Blue
5	White-blue	5	White-blue
6	Green	6	Orange
7	White-brown	7	White-brown
8	Brown	8	Brown
Pair 1		4 and 5	
Pair 2		1 and 2	
Pair 3		3 and 6	
Pair 4		7 and 8	

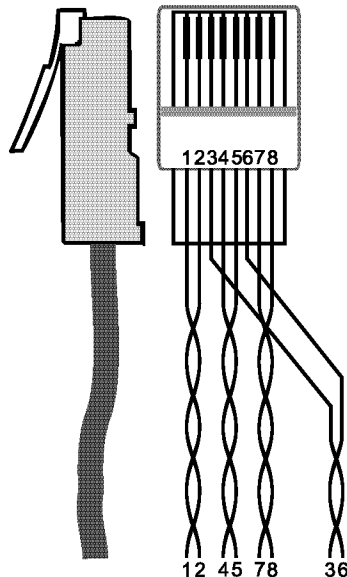

This type of connection is recommended for identification of the factory default IP Address of the **VS-42HC** during the initial configuration

After connecting the Ethernet port, configure your PC as follows:

1. Right-click the My Network Places icon on your desktop.
2. Select **Properties**.
3. Right-click Local Area Connection Properties.
4. Select **Properties**.
The Local Area Connection Properties window appears.

5. Select the Internet Protocol (TCP/IP) and click the **Properties** Button (see Figure 9).

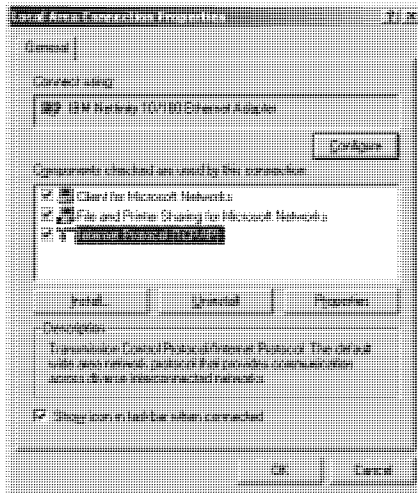

Figure 9: Local Area Connection Properties Window

6. Select Use the following IP address, and fill in the details as shown in Figure 10.
7. Click **OK**.

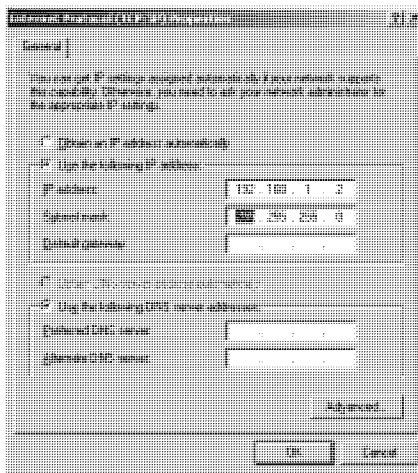

Figure 10: Internet Protocol (TCP/IP) Properties Window

7.3.2 Connecting the ETHERNET Port via a Network Hub (Straight-Through Cable)

You can connect the Ethernet port of the **VS-42HC** to the Ethernet port on a network hub or network router, via a straight-through cable with RJ-45 connectors, as Table 8 defines:

Table 8: Straight-through Cable RJ-45 PINOUT

Side 1		Side 2	
PIN	Wire Color	PIN	Wire Color
1	White-orange	1	White-orange
2	Orange	2	Orange
3	White-green	3	White-green
4	Blue	4	Blue
5	White-blue	5	White-blue
6	Green	6	Green
7	White-brown	7	White-brown
8	Brown	8	Brown

7.4 Configuring the Ethernet Port

To configure the ETHERNET port, do the following:

1. Connect the ETHERNET port as described in section 7.3.1.
2. Insert the CD-ROM in the CD-ROM drive, double click the Set FC11_xx.exe¹ file and follow the on-screen instructions². Both the Ethernet Configuration Manager and the Virtual Serial Port Manager are downloaded.
3. Click the appropriate shortcut in the Start menu's Programs folder. The Configuration Manager window (see Figure 11) opens.
4. Click the Search button³ (or the Action menu's, Search Board command). The MAC Address for the found ETHERNET port appears in the Device List.
5. Change the settings according to your network requirements and then click the Config button (or the Action menu's, Config command) to apply the settings.

Note that clicking the Config button will alter the IP settings of the ETHERNET port

¹ File names are liable to change from time to time

² The latest version appears on our Web site at <http://www.kramerelectronics.com>

³ To automatically search for devices

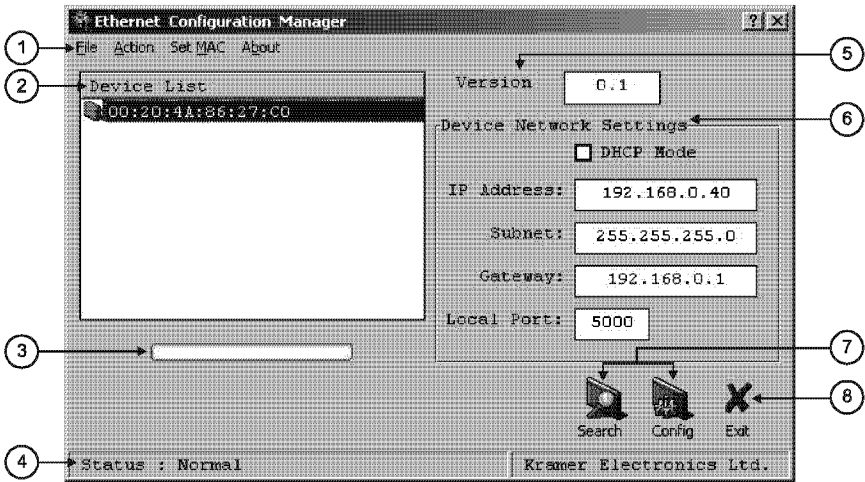

Figure 11: The Ethernet Configuration Manager Window

Table 9: Ethernet Configuration Manager Window Functionality

#	Feature	Function
1	File	The <i>Exit</i> command closes the Configuration Manager application
	Action	The <i>Search Board</i> command seeks the VS-42HC device that connects to the PC via the ETHERNET port, and displays it and its corresponding settings; The <i>Config</i> command adjusts the VS-42HC according to the displayed data
	Set MAC ¹	For factory use only (click the <i>Password</i> command to enter the password)
	About	Displays software information, including the software version
2	Device List	Displays the MAC Address
3	Progress Bar	Shows the progress
4	Status Bar	Shows the status
5	Version	Displays the firmware version
6	Device Network Settings Area	DHCP¹ Mode Check Box: When selected, configures the Ethernet port to obtain an IP address automatically from the DHCP server. When cleared, manual configuration of the Ethernet port is required to obtain an IP address (Static IP) IP Address: A 32-binary digit number obtained from your Network Administrator that identifies the Ethernet port that is currently being configured Subnet: A 32-binary digit number obtained from your Network Administrator, which combined with the IP Address, identifies which network your device is on Gateway: A network position serving as an entry to another network or to the Internet (only relevant in the Active Routing mode)
7	Exit Button	Closes the Configuration Manager application
8	Action Buttons	Search: seeks the devices that connect to the PC via the ETHERNET port, and displays them and their corresponding settings Config: adjusts the according to the displayed data

¹ See the definition in Table 1

7.4.1 Setting a Virtual Port

If the control application cannot work with an Ethernet driver, use the Kramer Virtual port driver as follows:

1. Run the Virtual Serial Port Manager Application.
The Virtual Serial Port Manager window appears (see Figure 12).



Figure 12: The Virtual Serial Port Manager Window

2. Press the **Add VSP** button to add a serial port and type the IP settings according to the IP address and local port of your **VS-42HC** (see Figure 13).

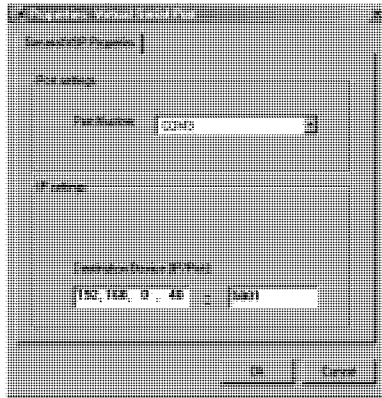

Figure 13: The Virtual Serial Port Properties Window

3. You can set a virtual port for each local port on your **VS-42HC** (see Figure 14).

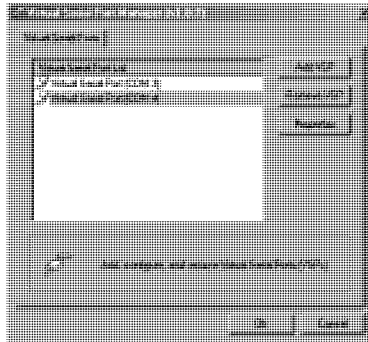

Figure 14: The Virtual Serial Port Properties Window (COM 3 and COM 4)

4. In the control application, choose the COM-port connection according to your virtual serial port connections (see Figure 15).

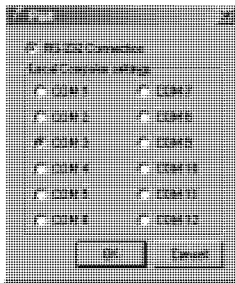

Figure 15: The Port Window – Selecting a Virtual Serial Port

7.4.2 Setting an Ethernet Connection

If the control application can directly connect to the Ethernet driver, select the host IP and port number, as illustrated in Figure 16.

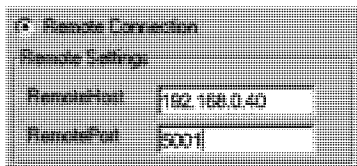

Figure 16: The Port Window – Selecting a Remote Connection

8 Operating the VS-42HC

You can operate your **VS-42HC** via:

- The front panel buttons
- RS-232/RS-485 serial commands transmitted by a touch screen system, PC, or other serial controller
- Infra-red remote control transmitter

This section describes:

- How to use the front panel buttons
- How to set and adjust the audio delay time

8.1 Switching OUT-IN Combinations

There are two sets of INPUT SELECTOR buttons, the first set, TO OUTPUT 1, for switching an input (from 1 to 4) to OUT 1 and the second set, TO OUTPUT 2, for switching an input (from 1 to 2) to OUT 2.

To switch a video/audio input to a video/audio output, press any of the INPUT SELECTOR buttons (from 1 to 4) TO OUTPUT 1 or TO OUTPUT 2, as required.

For example, press INPUT SELECTOR button 4 TO OUTPUT 1 and INPUT SELECTOR button 1 TO OUTPUT 2. Now IN 4 is switched to OUT 1 and IN 1 is switched to OUT 2. The corresponding buttons illuminate.

To turn off an output channel, press that channel's illuminated button once more.

8.2 Setting and Adjusting the Audio Delay Time

You can adjust the audio delay time for OUT 2 to correct lip sync errors so that the audio delay will match the video delay. The delay time can be set and stored separately for each input channel.

To set or adjust the audio delay, do the following:

1. Press the DELAY button on the front panel.
The DELAY button blinks
2. Press the + and – buttons to increase or decrease the delay time¹ respectively.
The + and – buttons illuminate.

¹ Press and hold the + or - buttons for speedy increase or decrease of the audio delay time respectively

Decrease or increase the delay time by looking and listening, until you see that the audio is synchronized with the video.

3. Once the delay time is set, press the DELAY button again to accept the delay time value.
The DELAY button illuminates.

The maximum delay time is set according to the input sampling rate¹, as described in Table 10:

Table 10: Maximum Delay Time according to Sampling Rate

Sampling Rate [kHz]	Maximum Delay Time [ms]
32	999
44	720
48	680
96	340

To cancel the delay time, press the DELAY button once again. The DELAY button light turns off.

To reset the delay time to 0 (zero), press and hold the DELAY button for a few seconds.

Table 11 summarizes the way the DELAY button responds.

Table 11: DELAY Button Response

When the DELAY button:	Then:
Blinks	You can view the sampling rate and the delay time value, or adjust the delay time
Illuminates	OUT 2 audio delay is on
Is not illuminated	OUT 2 audio delay is off
Is pressed for a few seconds	Delay time resets to 0 (zero)

¹ The sampling rate is specified by the source signal and cannot be changed by the switcher. The switcher automatically adjusts the maximum delay time value according to the sampling rate

8.3 Locking the Front Panel

To prevent changing the settings accidentally or tampering with the unit via the front panel buttons, lock¹ your **VS-42HC**. Unlocking releases the protection mechanism.

To lock the **VS-42HC**:

- Press the LOCK button
The LOCK button blinks. After pressing the LOCK button a second time, the front panel is locked. Pressing any other buttons will have no effect

To unlock the **VS-42HC**:

- Press the illuminated LOCK button
The LOCK button blinks
When pressing it a second time, the LOCK button no longer illuminates and the front panel unlocks

¹ Nevertheless, even though the front panel is locked you can still operate via Ethernet, RS-232 and RS-485, as well as via the Kramer IR Remote Control Transmitter

9 Flash Memory Upgrade

The **VS-42HC** lets you upgrade both microcontrollers:

- The Switcher Microcontroller (see section 9.1)
- The Ethernet Microcontroller (see section 9.2)

9.1 Switcher Flash Memory Upgrade

The **VS-42HC** firmware is located in FLASH memory, which lets you upgrade to the latest Kramer firmware version in minutes! The process involves:

- Downloading from the Internet (see section 9.1.1)
- Connecting the PC to the RS-232 port (see section 9.1.2)
- Upgrading Firmware (see section 9.1.3)

9.1.1 Downloading from the Internet

You can download the up-to-date file¹ from the Internet. To do so:

1. Go to our Web site at www.kramerelectronics.com and download the file: “*FLIP_VS42HC.zip*” from the Technical Support section.
2. Extract the file: “*FLIP_VS42HC.zip*” to a folder (for example, C:\Program Files\Kramer Flash).
3. Create a shortcut on your desktop to the file: “*FLIP.EXE*”.

9.1.2 Connecting the PC to the RS-232 Port

Before installing the latest Kramer firmware version on a **VS-42HC** unit, do the following:

1. Connect the RS-232 DB9 rear panel port according to section 7.1.
2. Push the rear panel Flash Upgr. button² to **Program** using a small screwdriver
3. Switch the unit ON

Note: this sequence is critical – first push the Flash Upgr. button and then turn on the unit

¹ The files indicated in this section are given as an example only. File names are liable to change from time to time

² Item 31 in Table 3

9.1.3 Upgrading Firmware

Follow these steps to upgrade the firmware:

1. Double click the desktop icon: “*Shortcut to FLIP.EXE*”.
The Splash screen appears as follows:

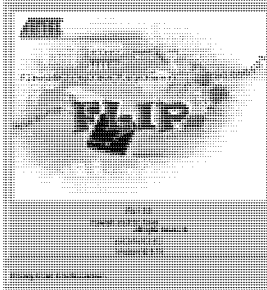

Figure 17: Splash Screen

2. After a few seconds, the Splash screen is replaced by the “*Atmel – Flip*” window:

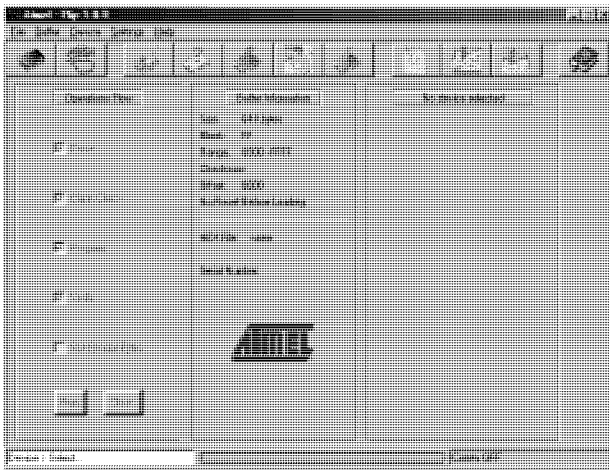

Figure 18: Atmel – Flip Window

3. Press the keyboard shortcut key *F2* (or select the “*Select*” command from the *Device* menu, or press the integrated circuit icon in the upper right corner of the window).
The “*Device Selection*” window appears:

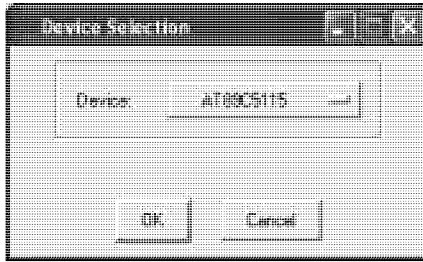

Figure 19: Device Selection Window

4. Click the button next to the name of the device and select from the list: AT89C51RD2:

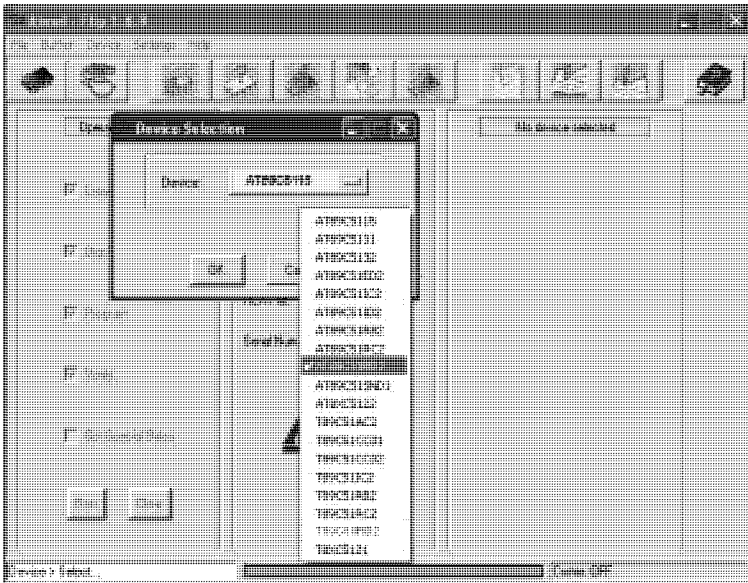

Figure 20: Device Selection window

5. Click OK and select “Load Hex” from the File menu.

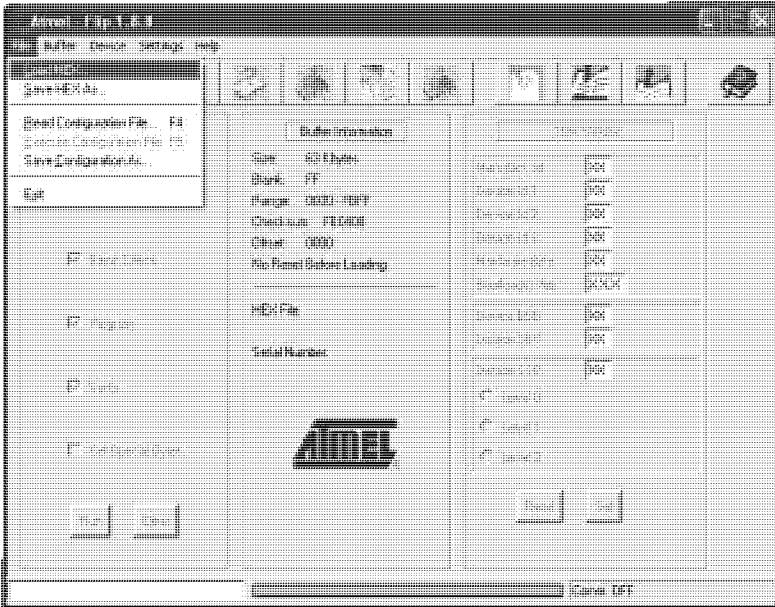

Figure 21: Loading the Hex

6. The Open File window opens. Select the correct HEX file that contains the updated version of the firmware for VS-42HC (for example *42M_V1p2.hex*) and click Open.
7. Press the keyboard shortcut key *F3* (or select the “*Communication / RS232*” command from the *Settings* menu, or press the keys: *Alt SCR*). The “*RS232*” window appears. Change the COM port according to the configuration of your computer and select the 9600 baud rate:

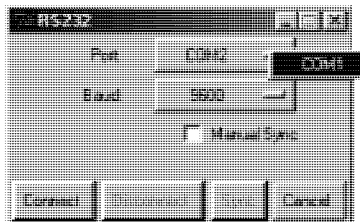

Figure 22: RS-232 Window

8. Click *Connect*.
In the “*Atmel – Flip*” window, in the *Operations Flow* column, the *Run* button is active, and the name of the chip appears as the name of the third column: *AT89C51RD2*.

Verify that in the *Buffer Information* column, the “*HEX File: VS42HC.hex*” appears.

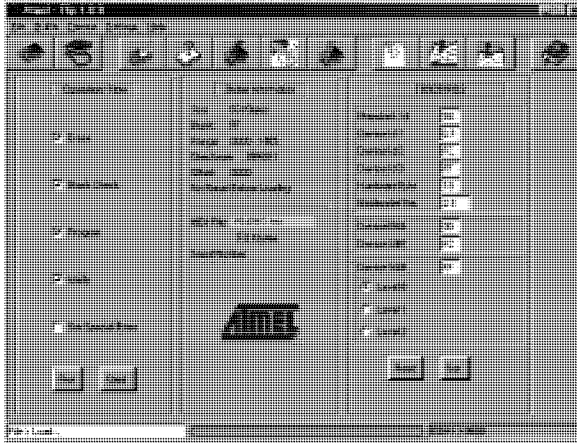

Figure 23: Atmel – Flip Window (Connected)

9. Click *Run*.

After each stage of the operation is completed, the check-box for that stage becomes colored green¹.

When the operation is completed, all 4 check-boxes will be colored green and the status bar message: *Memory Verify Pass* appears²:

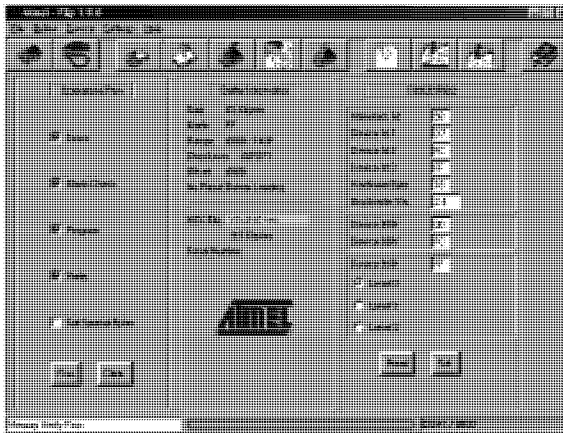

Figure 24: Atmel – Flip Window (Operation Completed)

¹ See also the blue progress indicator on the status bar

² If an error message: “Not Finished” shows, click Run again

10. Close the “*Atmel – Flip*” window.
11. Disconnect the power on the **VS-42HC**.
12. If required, disconnect the RS-232 rear panel port on the **VS-42HC** unit from the Null-modem adapter.
13. Release the Flash Upgr. button on the rear panel (Table 3).
14. Connect the power to the **VS-42HC**.
Upon initialization, the new **VS-42HC** software version shows in the INPUT STATUS 7-segment Display.

9.2 Ethernet Flash Memory Upgrade

The **VS-42HC** firmware is located in FLASH memory, which lets you upgrade to the latest Kramer firmware version in minutes!

The process involves:

- Downloading the upgrade package from the Internet
- Connecting the PC to the RS-232 port
- Upgrading the firmware

9.2.1 Downloading from the Internet

You can download the up-to-date file¹ from the Internet. To do so:

1. Go to our Web site at <http://www.Kramerelectronics.com> and download the file: “*SetKFRETH11-xx.zip*” from the technical support section.
2. Extract the file “*SetKFRETH11-xx.zip*” package, which includes the KFR-Programmer application setup and the *.s19* firmware file, to a folder (for example, C:\Program Files\KFR Upgrade).
3. Install the KFR-Programmer Application.

9.2.2 Connecting the PC to the RS-232 Port

Before installing the latest Kramer Ethernet firmware version on the **VS-42HC**, do the following:

1. Connect the RS-232 DB9 port (COM 1) on the **VS-42HC** to a Null-modem adapter and connect the Null-modem adapter with a 9-wire flat cable to the RS-232 DB9 COM port on your PC.
2. Set the ETH Flash/Normal switch, located on the machine underside, to ETH Flash.
3. Connect the power on your machine.

¹ File names are liable to change from time to time

9.2.3 Upgrading Firmware

Follow these steps to upgrade the firmware:

1. Double click the KFR-Programmer desktop icon.
The KFR-Programmer window appears (see Figure 25).

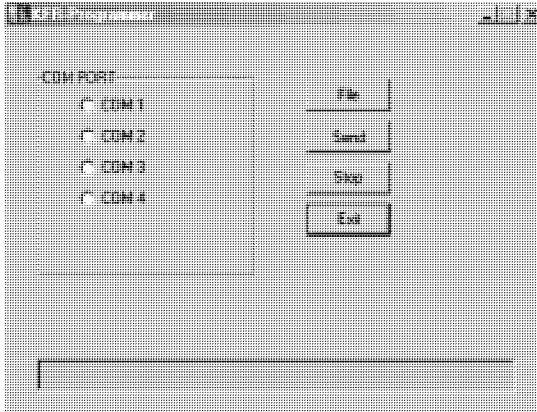

Figure 25: The KFR-Programmer Window

2. Select the required COM Port¹.
3. Press the File button to select the `.s19` firmware file included in the package.
4. Press the Send button to download the file. The Send button lights red.
5. Wait until downloading is completed and the red Send button turns off.
6. Disconnect the power on the **VS-42HC**.
7. Set the ETH Flash/Normal switch, located on the machine underside, to Normal.
8. Connect the power on your machine.

¹ To which the VS-42HC is connected on your PC

10 Technical Specifications

Table 12 includes the technical specifications:

Table 12: Technical Specifications¹ of the VS-42HC

Video Components	
INPUTS:	4 sets of component video (Y, Pb/Cb, Pr/Cr) 1Vpp, 0.7Vpp, 0.7Vpp / 75Ω on RCA connectors
OUTPUTS:	2 sets of component video (Y, Pb/Cb, Pr/Cr) 1Vpp, 0.7Vpp, 0.7Vpp / 75Ω on RCA connectors
MAX. OUTPUT LEVEL:	2.3Vpp
BANDWIDTH (-3dB):	200MHz, Fully Loaded
DIFF. GAIN:	0.08%
DIFF. PHASE:	0.77 Deg
K-FACTOR:	<0.05%
S/N RATIO:	73dB weighted
CROSSTALK (all hostile):	-53dB @ 5MHz
COUPLING:	DC
Audio Components	
INPUTS:	4 S/PDIF digital audio, on RCA connectors; 1 TOSLINK optical
OUTPUTS:	2 S/PDIF digital audio, on RCA connectors; 1 TOSLINK optical
S/PDIF SAMPLE RATE:	Up to 192kHz
RESOLUTION:	Up to 24 bits
JITTER:	<1.5ns (50Hz to 100kHz) without delay, <3.5ns (50Hz to 100kHz) with delay
MAXIMUM DELAY TIME FOR CHANNEL 2:	999ms @ 32kHz sample rate; 720ms @ 44.1kHz sample rate; 680ms @ 48kHz sample rate; 340ms @ 96kHz sample rate
DELAY RESOLUTION:	1ms
General	
CONTROLS:	Front panel buttons, Ethernet, RS-232, RS-485, IR remote control
POWER SOURCE:	100-240 VAC, 50/60 Hz; 90mA switching power supply
DIMENSIONS:	19-inch (W), 7-inch (D) 1U (H) rack-mountable
WEIGHT:	2.7 kg (6 lbs.) approx.
ACCESSORIES:	Power cord, Null modem adapter, Windows®-based Kramer control software, Windows®-based Ethernet Configuration Manager and Virtual Serial Port Manager, Infra-red remote control transmitter

¹ Specifications are subject to change without notice

11 Table of Hex Codes for Serial Communication (RS-232/RS-485 Protocol)

Sections 11.1 and 11.2 contain the tables of hex codes for switching and setting the delay time, respectively.

11.1 Hex Codes for Switching

Table 13 lists the Hex values for a single machine (machine # 1):

Table 13: VS-42HC Hex Codes for Switching via RS-232/RS-485

	Switching Video Channels		Switching Audio Channels	
	OUT 1	OUT 2	OUT 1	OUT 2
IN 1	01	01	02	02
	81	81	81	81
	81	82	81	82
	81	81	81	81
IN 2	01	01	02	02
	82	82	82	82
	81	82	81	82
	81	81	81	81
IN 3	01	01	02	02
	83	83	83	83
	81	82	81	82
	81	81	81	81
IN 4	01	01	02	02
	84	84	84	84
	81	82	81	82
	81	81	81	81

11.2 VS-44HC Hex Codes for Setting the Audio Delay Time

To set the audio delay time, use command 22 (set audio parameter) in the following way:

- Byte 1 should be 22 (16H)
- Byte 2 should be 128 (80H) plus input Channel number (from 1 to 4)
- Byte 3 should be 128 (80H) plus delay value in milliseconds (from 1 to 127)¹
- Byte 4 should be 128 (80H) plus machine number (from 1 to 15)

¹ For delay times up to 127ms

Table 14 describes several examples for the hex codes used to set the delay time:

Table 14: VS-42HC Hex Codes for Setting the Audio Delay Time

Delay Time [ms]	For	Command			
0	IN 1	16	81	80	81
5	IN 2	16	82	85	81
64	IN 3	16	83	84	81
127	IN 4	16	84	FF	81

For delay times exceeding 127ms, you need to send two commands (eight bytes).

The first command includes the most significant bits:

- Byte 1 should be 63 (7FH)
- Byte 2 should be 128 (80H) plus Most Significant bits of required delay
- Byte 3 should be 128 (80H)
- Byte 4 should be 128 (80H) plus machine number (from 1 up to 15)

The second command includes the less significant bits as described previously for command 22.

Table 15 describes the hex code examples for setting the audio delay time for delays more than 127ms:

Table 15: VS-42HC Hex Codes for increasing the Audio Delay Time

Delay Time for IN 1 [ms]	Command			
128	7F	80	81	81
	16	81	80	81
130	7F	80	81	81
	16	81	82	81
200	7F	80	81	81
	16	81	C8	81
680	7F	80	85	81
	16	81	A8	81

To increase or decrease the delay time by 1ms, the following command is set:

- Byte 1 should be 24 (18H)
- Byte 2 should be 128 (80H) plus machine number (from 1 to 15)
- Byte 3 should be 140 (8CH) to increment; or 141 (8DH) to decrement
- Byte 4 should be 129 (81H)

To increase, for example, the IN 1 audio delay time by 1ms, the hex code would be:

18	82	8C	81
----	----	----	----

To decrease, for example, the IN 4 audio delay time by 1ms, the hex code would be:

18	84	8D	81
----	----	----	----

LIMITED WARRANTY

Kramer Electronics (hereafter *Kramer*) warrants this product free from defects in material and workmanship under the following terms.

HOW LONG IS THE WARRANTY

Labor and parts are warranted for seven years from the date of the first customer purchase.

WHO IS PROTECTED?

Only the first purchase customer may enforce this warranty.

WHAT IS COVERED AND WHAT IS NOT COVERED

Except as below, this warranty covers all defects in material or workmanship in this product. The following are not covered by the warranty:

1. Any product which is not distributed by Kramer, or which is not purchased from an authorized Kramer dealer. If you are uncertain as to whether a dealer is authorized, please contact Kramer at one of the agents listed in the Web site www.kramerelectronics.com.
2. Any product, on which the serial number has been defaced, modified or removed.
3. Damage, deterioration or malfunction resulting from:
 - i) Accident, misuse, abuse, neglect, fire, water, lightning or other acts of nature
 - ii) Product modification, or failure to follow instructions supplied with the product
 - iii) Repair or attempted repair by anyone not authorized by Kramer
 - iv) Any shipment of the product (claims must be presented to the carrier)
 - v) Removal or installation of the product
 - vi) Any other cause, which does not relate to a product defect
 - vii) Cartons, equipment enclosures, cables or accessories used in conjunction with the product

WHAT WE WILL PAY FOR AND WHAT WE WILL NOT PAY FOR

We will pay labor and material expenses for covered items. We will not pay for the following:

1. Removal or installations charges.
2. Costs of initial technical adjustments (set-up), including adjustment of user controls or programming. These costs are the responsibility of the Kramer dealer from whom the product was purchased.
3. Shipping charges.

HOW YOU CAN GET WARRANTY SERVICE

1. To obtain service on you product, you must take or ship it prepaid to any authorized Kramer service center.
2. Whenever warranty service is required, the original dated invoice (or a copy) must be presented as proof of warranty coverage, and should be included in any shipment of the product. Please also include in any mailing a contact name, company, address, and a description of the problem(s).
3. For the name of the nearest Kramer authorized service center, consult your authorized dealer.

LIMITATION OF IMPLIED WARRANTIES

All implied warranties, including warranties of merchantability and fitness for a particular purpose, are limited in duration to the length of this warranty.

EXCLUSION OF DAMAGES

The liability of Kramer for any effective products is limited to the repair or replacement of the product at our option. Kramer shall not be liable for:

1. Damage to other property caused by defects in this product, damages based upon inconvenience, loss of use of the product, loss of time, commercial loss; or:
2. Any other damages, whether incidental, consequential or otherwise. Some countries may not allow limitations on how long an implied warranty lasts and/or do not allow the exclusion or limitation of incidental or consequential damages, so the above limitations and exclusions may not apply to you.

This warranty gives you specific legal rights, and you may also have other rights, which vary from place to place.

NOTE: All products returned to Kramer for service must have prior approval. This may be obtained from your dealer.

This equipment has been tested to determine compliance with the requirements of:

- EN-50081: "Electromagnetic compatibility (EMC);
generic emission standard.
Part 1: Residential, commercial and light industry"
- EN-50082: "Electromagnetic compatibility (EMC) generic immunity standard.
Part 1: Residential, commercial and light industry environment".
- CFR-47:
FCC Rules and Regulations:
Part 15: "Radio frequency devices
Subpart B – Unintentional radiators"

CAUTION!

- ☒ Servicing the machines can only be done by an authorized Kramer technician. Any user who makes changes or modifications to the unit without the expressed approval of the manufacturer will void user authority to operate the equipment.
- ☒ Use the supplied DC power supply to feed power to the machine.
- ☒ Please use recommended interconnection cables to connect the machine to other components.





For the latest information on our products and a list of Kramer distributors, visit our Web site: www.kramerelectronics.com, where updates to this user manual may be found. We welcome your questions, comments and feedback.

 <p>Caution</p>	<p>Safety Warning: Disconnect the unit from the power supply before opening/servicing.</p>
---	---



Kramer Electronics, Ltd.
Web site: www.kramerelectronics.com
E-mail: info@kramereel.com
P/N: 2900-000132 REV 1