

Kramer Electronics, Ltd.



USER MANUAL

Models:

VM-2N, *Video Audio Distributor*

VM-5S, *Video Audio Distributor*

VM-50HN, *Headphone Distributor*

VM-50V, *1:5 Video Distributor*

VM-50YC, *1:5 s-Video Distributor*

Contents

1	Introduction	1
2	Getting Started	1
2.1	Quick Start	2
3	Overview	4
3.1	The VM-2N Video Audio Distributor	4
3.2	The VM-5S Video Audio Distributor	4
3.3	The VM-50HN Headphone Distributor	5
3.4	The VM-50V 1:5 Video Distributor	5
3.5	The VM-50YC 1:5 s-Video Distributor	5
4	Your Distributor	6
4.1	Your VM-2N Video Audio Distributor	7
4.2	Your VM-5S Video Audio Distributor	8
4.3	Your VM-50HN Headphone Distributor	9
4.4	Your VM-50V 1:5 Video Distributor	10
4.5	Your VM-50YC 1:5 s-Video Distributor	11
5	Connecting the Distributors	11
5.1	Connecting the VM-2N Video Audio Distributor	12
5.2	Connecting the VM-5S Video Audio Distributor	13
5.3	Connecting the VM-50HN Headphone Distributor	14
5.4	Connecting the VM-50V 1:5 Video Distributor	15
5.5	Connecting the VM-50YC 1:5 s-Video Distributor	16
6	Technical Specifications	17

Figures

Figure 1:	VM-2N Video Audio Distributor	7
Figure 2:	VM-5S Video Audio Distributor	8
Figure 3:	VM-50HN Headphone Distributor	9
Figure 4:	VM-50V 1:5 Video Distributor	10
Figure 5:	VM-50YC 1:5 s-Video Distributor	11
Figure 6:	Connecting the VM-2N Video Audio Distributor	12
Figure 7:	Connecting the VM-5S Video Audio Distributor	13
Figure 8:	Connecting the VM-50HN Headphone Distributor	14
Figure 9:	Connecting the VM-50V 1:5 Video Distributor	15
Figure 10:	Connecting the VM-50YC 1:5 s-Video Distributor	16

Tables

Table 1: VM-2N Video Audio Distributor	7
Table 2: VM-5S Video Audio Distributor	8
Table 3: VM-50HN Headphone Distributor	9
Table 4: VM-50V 1:5 Video Distributor	10
Table 5: VM-50YC 1:5 s-Video Distributor	11
Table 6: VM-2N Technical Specifications	17
Table 7: VM-50HN Technical Specifications	17
Table 8: VM-5S Technical Specifications	18
Table 9: VM-50V Technical Specifications	18
Table 10: VM-50YC Technical Specifications	19

1 Introduction

Welcome to Kramer Electronics! Since 1981, Kramer Electronics has been providing a world of unique, creative, and affordable solutions to the vast range of problems that confront the video, audio, presentation, and broadcasting professional on a daily basis. In recent years, we have redesigned and upgraded most of our line, making the best even better! Our 1,000-plus different models now appear in 11 groups¹ that are clearly defined by function.

Thank you for purchasing the Kramer **VM-2N, VM-5S, VM-50HN, VM-50V, VM-50YC** *Video Distribution Amplifiers*, which are ideal for:

- Any professional A/V system requiring a compact, high-quality DA
- Retail stores and other point-of-sale display systems
- Security and CCTV applications
- Studio RGB/YUV distribution

Each package includes the following items:

- The **VM-2N, VM-5S, VM-50HN, VM-50V** or **VM-50YC**
- Power cord² or power adapter (12V DC input)
- This user manual³

2 Getting Started

We recommend that you:

- Unpack the equipment carefully and save the original box and packaging materials for possible future shipment
- Review the contents of this user manual
- Use Kramer high-performance high-resolution cables⁴

1 GROUP 1: Distribution Amplifiers; GROUP 2: Switchers and Matrix Switchers; GROUP 3: Control Systems; GROUP 4: Format/Standards Converters; GROUP 5: Range Extenders and Repeaters; GROUP 6: Specialty AV Products; GROUP 7: Scan Converters and Scalers; GROUP 8: Cables and Connectors; GROUP 9: Room Connectivity; GROUP 10: Accessories and Rack Adapters; GROUP 11: Sierra Products

2 We recommend that you use only the power cord supplied with this device

3 Download up-to-date Kramer user manuals from our Web site at <http://www.kramerelectronics.com>

4 The complete list of Kramer cables is on our Web site at <http://www.kramerelectronics.com>

2.1 Quick Start

This quick start chart summarizes the basic setup and operation steps.

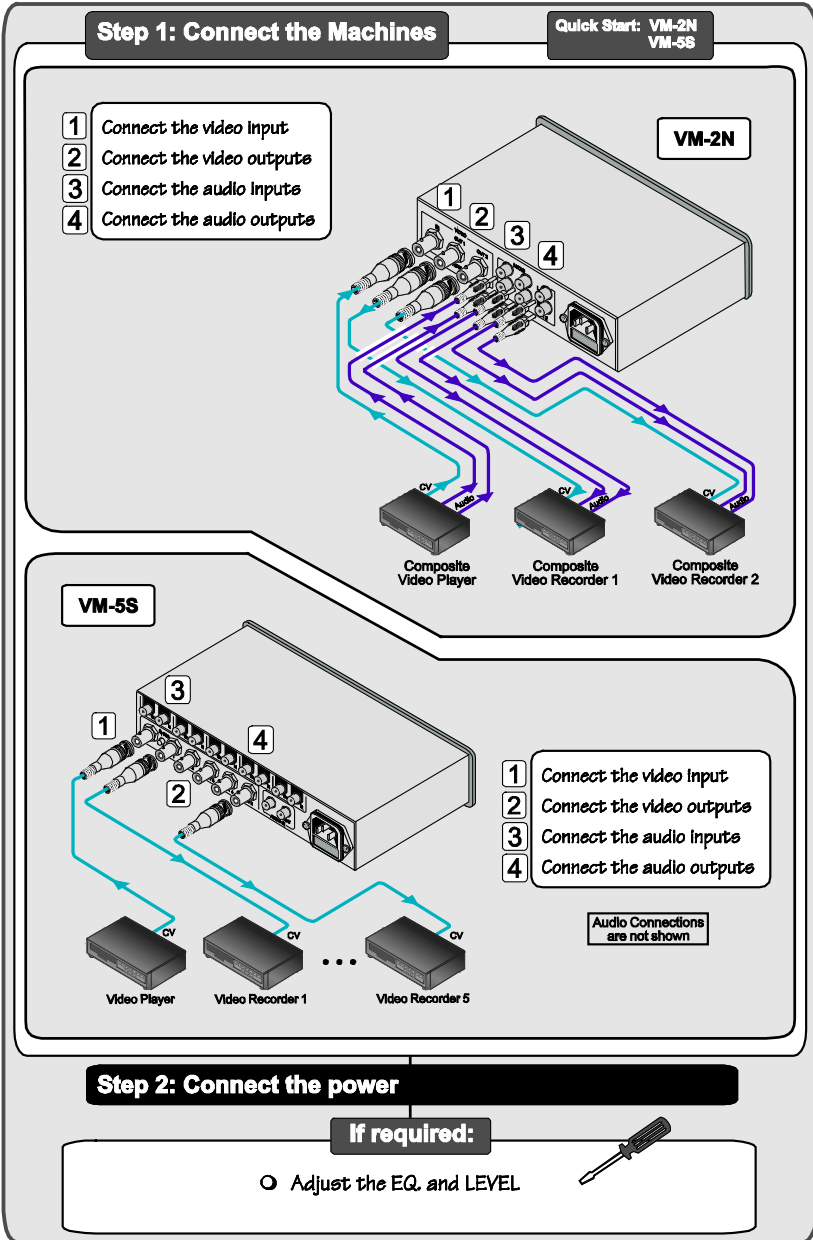

Step 1: Connect the Machines

Quick Start: VM-50V
VM-50YC

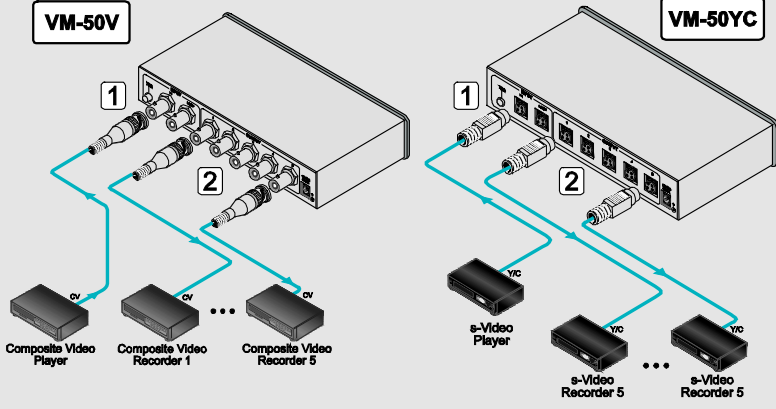

- 1 Connect the video input
- 2 Connect the video outputs

VM-50HN-
New MultiTOOL®

Quick Start: VM-50HN

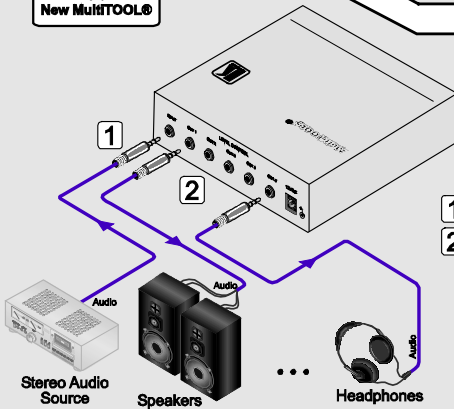

- 1 Connect the stereo audio input
- 2 Connect the stereo audio outputs

Step 2: Connect the power

If required:

- Adjust the EQ, and LEVEL

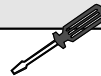

3 Overview

This section gives an overview of the:

- **VM-2N Video Audio Distributor**, see section [3.1](#)
- **VM-5S Video Audio Distributor**, see section [3.2](#)
- **VM-50HN Headphone Distributor**, see section [3.3](#)
- **VM-50V 1:5 Video Distributor**, see section [3.4](#)
- **VM-50YC 1:5 s-Video Distributor**, see section [3.5](#)

3.1 The VM-2N Video Audio Distributor

The Kramer **VM-2N** is a high-performance distribution amplifier for composite or SDI video and unbalanced stereo audio signals. It takes one input, provides correct buffering and isolation and distributes the signal to two identical outputs.

More specifically, the **VM-2N** features:

- High bandwidth (Y) of 400MHz (-3dB)
- 1 composite video input and 2 outputs on BNC connectors
- 1 unbalanced stereo input and 2 outputs on RCA connectors
- Level and equalization controls
- AC power supply
- Compact desktop size

3.2 The VM-5S Video Audio Distributor

The Kramer **VM-5S** is a high-performance distribution amplifier for composite or SDI video and unbalanced stereo audio signals. It takes one input, provides correct buffering and isolation and distributes the signal to 5 identical outputs.

More specifically, the **VM-5S** features:

- High bandwidth of 340MHz (-3dB)
- 1 video input and 5 outputs on BNC connectors
- 1 unbalanced stereo input and 5 outputs on RCA connectors
- Looped input capability
- Selectable input signal termination
- Audio level, video level and equalization controls
- AC power supply
- Compact desktop size

3.3 The VM-50HN Headphone Distributor

The Kramer MultiTOOLS® **VM-50HN** is a high-performance distribution amplifier for headphone signals. It takes one stereo headphone input and distributes the signal to five identical stereo headphone outputs.

More specifically, the **VM-50HN** features:

- 1 mono/stereo audio input and 5 outputs on 6.5mm phone connectors with mono/stereo selector
- Level gain controls for each output
- Power LED indicator
- 12V DC power supply
- MultiTOOLS® size

3.4 The VM-50V 1:5 Video Distributor

The Kramer **VM-50V** is a high-performance distribution amplifier for composite or SD I signals. It takes one input, provides correct buffering and isolation, and distributes the signal to five identical outputs.

More specifically, the **VM-50V** features:

- High bandwidth of 480MHz (-3dB)
- 1 video input, 1 looping input, and 5 outputs on BNC connectors
- Selectable input signal termination
- Signal level and equalization controls
- 12V DC power supply
- Compact desktop size

3.5 The VM-50YC 1:5 s-Video Distributor

The Kramer **VM-50YC** is a high-performance distribution amplifier for s-Video (Y/C) signals. It takes one input, provides correct buffering and isolation, and distributes the signal to 5 identical outputs.

More specifically, the **VM-50YC** features:

- High bandwidth (Y) of 285MHz (-3dB)
- 1 looping input, and 5 outputs on 4-pin connectors
- Selectable input signal termination
- 12V DC power supply
- Compact desktop size



Caution – No operator-serviceable parts inside unit.

Warning – Use only the Kramer Electronics input power wall adapter that is provided with this unit¹.

Warning – Disconnect power and unplug unit from wall before installing or removing device or servicing unit.

To achieve the best performance:

- Use only good quality connection cables² to avoid interference, deterioration in signal quality due to poor matching, and elevated noise levels (often associated with low quality cables).
- Avoid interference from neighboring electrical appliances that may adversely influence signal quality and position your Kramer product away from moisture, excessive sunlight and dust

4 Your Distributor

This section describes the:

- **VM-2N** *Video Audio Distributor*, see section [4.1](#)
- **VM-5S** *Video Audio Distributor*, see section [4.2](#)
- **VM-50HN** *Headphone Distributor*, see section [4.3](#)
- **VM-50V** *1:5 Video Distributor*, see section [4.4](#)
- **VM-50YC** *1:5 s-Video Distributor*, see section [4.5](#)

¹ For example, part number 22535-000251

² Available from Kramer Electronics on our Web site at <http://www.kramerelectronics.com>

4.1 Your VM-2N Video Audio Distributor

[Figure 1](#) and [Table 1](#) define the VM-2N.

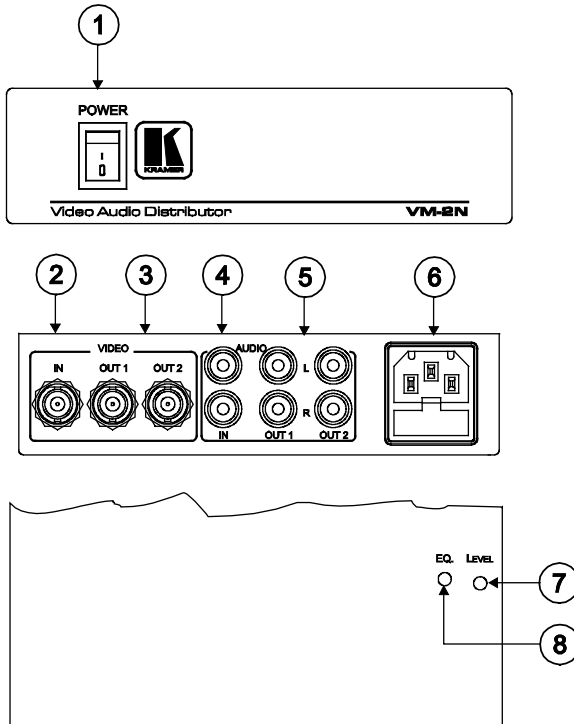

Figure 1: VM-2N Video Audio Distributor

Table 1: VM-2N Video Audio Distributor

#	Feature	Function
1	Illuminated Power Switch	Illuminated switch for turning the unit ON or OFF
2	VIDEO IN BNC Connector	Connects to the video source
3	VIDEO OUT BNC Connectors	Connect to the video acceptor (from 1 to 2)
4	AUDIO IN RCA Connectors (L and R)	Connect to the L and R channels of the audio source
5	AUDIO OUT RCA Connectors (L and R)	Connect to the L and R channels of the audio acceptor (from 1 to 2)
6	Power Connector with Fuse	AC connector for supplying power to the unit
7	LEVEL Control (underside)	Adjust ¹ the audio signal output level
8	EQ. Control (underside)	Adjust the cable compensation equalization level

¹ Insert a small screwdriver into the hole and carefully rotate it to trim the level

4.2 Your VM-5S Video Audio Distributor

[Figure 2](#) and [Table 2](#) define the VM-5S.

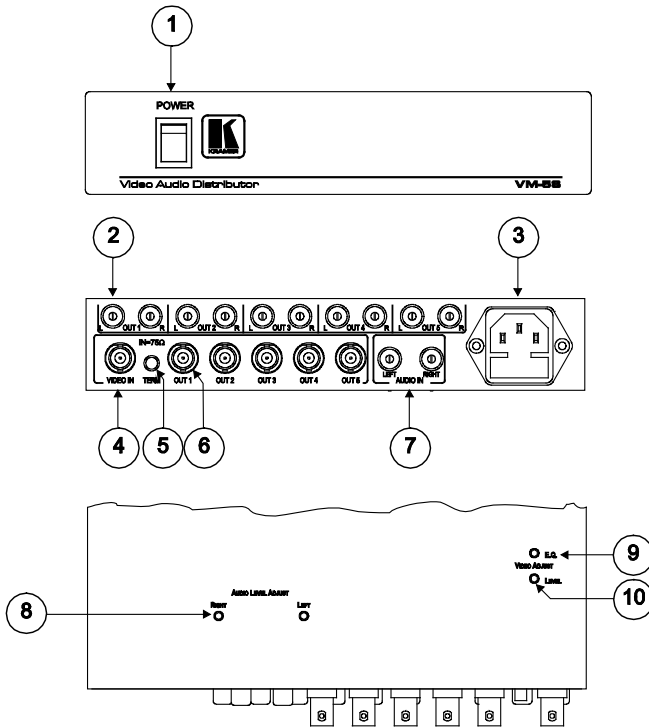

Figure 2: VM-5S Video Audio Distributor

Table 2: VM-5S Video Audio Distributor

#	Feature	Function
1	Illuminated Power Switch	Illuminated switch for turning the unit ON or OFF
2	AUDIO OUT RCA Connectors	Connect to the audio acceptor (from 1 to 5)
3	Power Connector with FUSE	AC connector for supplying power to the unit
4	VIDEO IN BNC Connector	Connects to the video source
5	TERM Pushbutton Switch	Press IN for 75Ω input termination, leave OUT for no termination
6	VIDEO OUT BNC Connectors	Connect to the video acceptors (from 1 to 5)
7	AUDIO IN RCA Connectors (L and R)	Connect to the L and R channels of the audio source
8	AUDIO LEVEL ADJUST L and R	Adjust ¹ the audio signal output level
9	VIDEO EQ. Control (underside)	Adjust ¹ the cable compensation equalization level
10	VIDEO LEVEL Control (underside)	Adjust ¹ the video signal output level

¹ Insert a small screwdriver into the hole and carefully rotate it to trim the level

4.3 Your VM-50HN Headphone Distributor

[Figure 3](#) and [Table 3](#) define the VM-50HN.

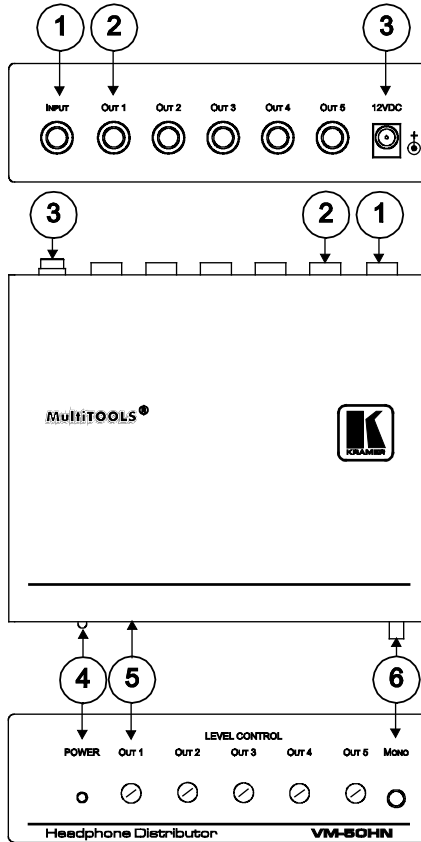

Figure 3: VM-50HN Headphone Distributor

Table 3: VM-50HN Headphone Distributor

#	Feature	Function
1	INPUT 6.5mm phone connector	Connects to the input source
2	OUT 6.5mm phone connectors	Connect to the headphones (1 to 5)
3	12V DC Connector	Connects to the 12V DC power supply
4	POWER LED	Illuminates when the unit is ON
5	LEVEL CONTROL Potentiometers	Adjust ¹ the audio signal output level (OUT 1 to OUT 5)
6	MONO Pushbutton	Press IN for mono audio, leave OUT for stereo audio

¹ Rotate to adjust the appropriate level

4.4 Your VM-50V 1:5 Video Distributor

[Figure 4](#) and [Table 4](#) define the VM-50V.

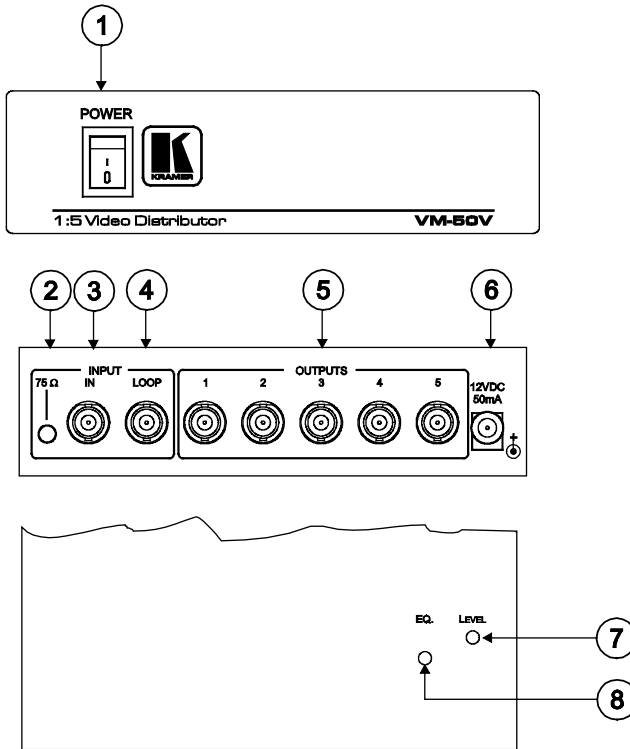

Figure 4: VM-50V 1:5 Video Distributor

Table 4: VM-50V 1:5 Video Distributor

#	Feature	Function
1	Illuminated Power Switch	Illuminated switch for turning the unit ON or OFF
2	TERM Pushbutton Switch	Press IN for 75Ω input termination, leave OUT for no termination
3	INPUT IN BNC Connector	Connects to the video source
4	INPUT LOOP BNC Connector	Connects to an additional monitor
5	OUTPUTS BNC Connectors	Connect to the video acceptors (from 1 to 5)
6	12V DC Connector	Connects to the 12V DC power supply
7	LEVEL Control (underside)	Adjust ¹ the audio signal output level
8	EQ. Control (underside)	Adjust ¹ the cable compensation equalization level

¹ Insert a small screwdriver into the hole and carefully rotate it to trim the level

4.5 Your VM-50YC 1:5 s-Video Distributor

[Figure 5](#) and [Table 5](#) define the VM-50YC.

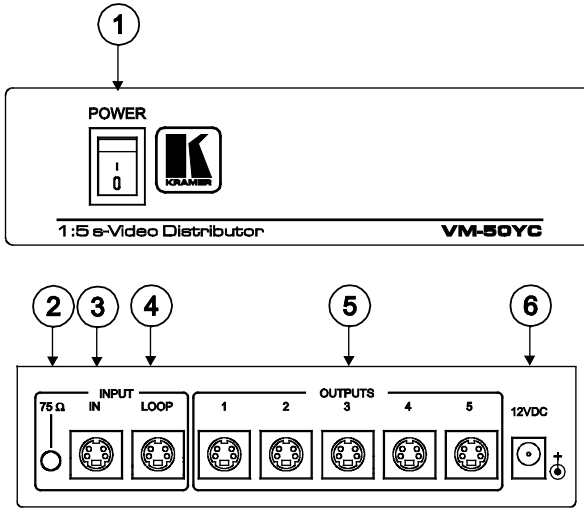

Figure 5: VM-50YC 1:5 s-Video Distributor

Table 5: VM-50YC 1:5 s-Video Distributor

#	Feature	Function
1	Illuminated Power Switch	Illuminated switch for turning the unit ON or OFF
2	TERM Pushbutton Switch	Press IN for 75Ω input termination, leave OUT for no termination
3	INPUT IN s-Video Connector	Connects to the s-Video source
4	INPUT LOOP s-Video Connector	Connects to an additional monitor
5	OUTPUTS s-Video Connectors	Connect to the s-Video acceptors (from 1 to 5)
6	12V DC Connector	Connects to the 12V DC power supply

5 Connecting the Distributors

This section describes how to connect the:

- **VM-2N Video Audio Distributor**, see section [5.1](#)
- **VM-5S Video Audio Distributor**, see section [5.2](#)
- **VM-50HN Headphone Distributor**, see section [5.3](#)
- **VM-50V 1:5 Video Distributor**, see section [5.4](#)
- **VM-50YC 1:5 s-Video Distributor**, see section [5.5](#)

5.1 Connecting the VM-2N Video Audio Distributor

To connect the VM-2N, as shown in [Figure 6](#), do the following¹:

1. Connect the input video source (for example, a composite video player) to the VIDEO IN BNC connector.
2. Connect the input audio source (for example, the audio from a composite video player) to the AUDIO IN RCA connectors noting the right and left channels.
3. Connect the VIDEO OUT 1 and 2 BNC connectors to up to 2 acceptors² (for example, composite video recorders).
4. Connect the AUDIO OUT 1 and 2 RCA connectors to up to 2 acceptors² (for example, the audio input on the composite video recorders).
5. Connect the power cord³ to the unit (not shown in the illustration) and then to the mains electricity. Switch on the power.
6. If needed, adjust the LEVEL and EQ controls on the underside of the unit (see [Figure 1](#)).

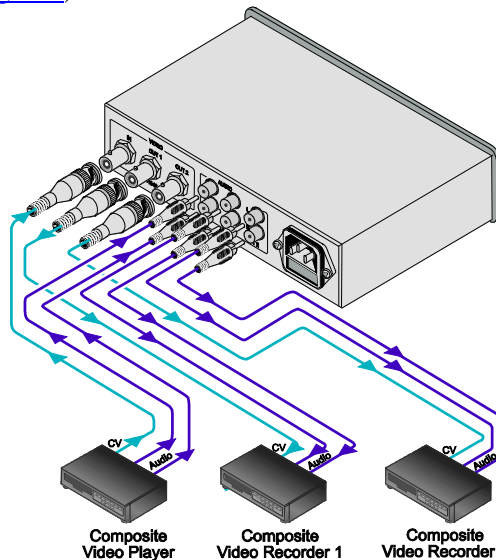

Figure 6: Connecting the VM-2N Video Audio Distributor

1 Switch OFF the power on each device before connecting it to your VM-2N. After connecting, switch on the VM-2N power and then switch on the power on each device

2 You are not required to connect two acceptors

3 Use the power cord supplied with the unit

5.2 Connecting the VM-5S Video Audio Distributor

To connect the VM-5S, as shown in [Figure 7](#), do the following¹:

1. Connect the input video source (for example, a video player) to the VIDEO IN BNC connector.
2. Connect the input audio source (for example, the audio from the video player) to the AUDIO IN RCA connectors noting the right and left channels.
3. Connect the VIDEO OUT 1 to 5 BNC connectors to up to 5 acceptors² (for example, video recorders).
4. Connect the AUDIO OUT 1 and 5 RCA connectors to up to 5 acceptors² (for example, the audio input on the video recorders).
5. For normal use (the input loop is not used), press IN the TERM pushbutton to add a 75Ω termination to the line. If an input loop is used, release the TERM pushbutton.
6. Connect the power cord³ to the unit (not shown in the illustration) and then to the mains electricity. Switch on the power.
7. If needed, adjust the AUDIO LEVEL and VIDEO LEVEL and EQ controls on the underside of the unit (see [Figure 2](#)).

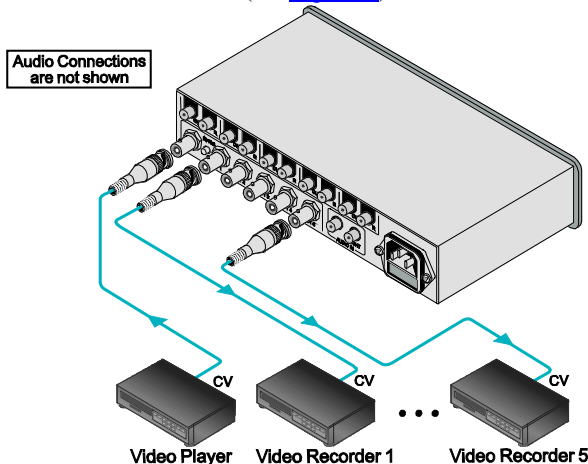

Figure 7: Connecting the VM-5S Video Audio Distributor

1 Switch OFF the power on each device before connecting it to your VM-5S. After connecting, switch on the VM-5S power and then switch on the power on each device

2 You are not required to connect all the acceptors

3 Use the power cord supplied with the unit

5.3 Connecting the VM-50HN Headphone Distributor

To connect the **VM-50HN**, as shown in [Figure 8](#), do the following¹:

1. Connect the input audio source (for example, a stereo audio player) to the INPUT 6.5mm phone connector.
2. Connect the OUT 1 to OUT 5 6.5mm phone connectors to up to 5 acceptors² (for example, stereo headphones or speakers).
3. Set the MONO pushbutton OUT for stereo operation and press IN for mono operation (see [Figure 3](#)).
4. Connect the 12V DC power supply to the unit (not shown in the illustration) and then to the mains electricity. Switch on the power.
5. Adjust the volume for each output using a small screwdriver to turn the potentiometers on the front panel (see [Figure 3](#)).

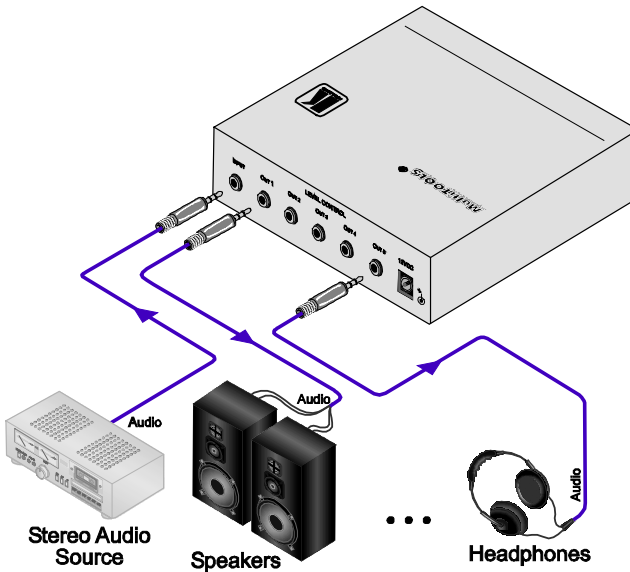

Figure 8: Connecting the VM-50HN Headphone Distributor

¹ Switch OFF the power on each device before connecting it to your VM-50HN. After connecting, switch on the VM-50HN power and then switch on the power on each device

² You are not required to connect all the acceptors

5.4 Connecting the VM-50V 1:5 Video Distributor

To connect the **VM-50V**, as shown in [Figure 9](#), do the following¹:

1. Connect the input video source (for example, a composite video player) to the INPUT IN BNC connector.
2. If looping the input to another device, connect a video acceptor (for example a monitor) to the INPUT LOOP BNC connector.
3. If the input loop is not used, press IN the TERM pushbutton to add a 75 Ω termination to the line. If an input loop is used, release the TERM pushbutton.
4. Connect the VIDEO OUT 1 to 5 BNC connectors to up to 5 acceptors² (for example, composite video recorders).
5. Connect the 12V DC power supply to the unit (not shown in the illustration) and then to the mains electricity. Switch on the power.
6. If needed, adjust the LEVEL and EQ controls on the underside of the unit (see [Figure 4](#)).

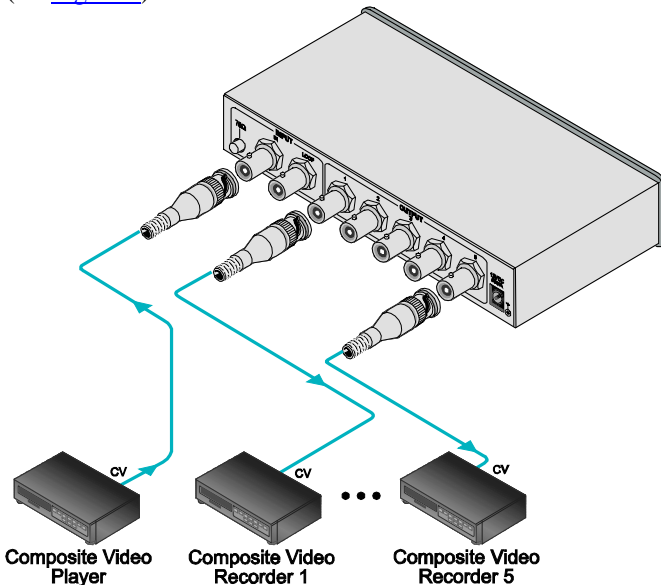

Figure 9: Connecting the VM-50V 1:5 Video Distributor

¹ Switch OFF the power on each device before connecting it to your VM-50V. After connecting, switch on the VM-50V power and then switch on the power on each device

² You are not required to connect all the acceptors

5.5 Connecting the VM-50YC 1:5 s-Video Distributor

To connect the **VM-50YC**, as shown in [Figure 10](#), do the following¹:

1. Connect the input video source (for example, an s-video player) to the **INPUT IN** s-video connector.
2. If looping the input to another device, connect a video acceptor (for example an s-video monitor) to the **INPUT LOOP** s-video connector.
3. If the input loop is not used, press **IN** the **TERM** pushbutton to add a 75 Ω termination to the line. If an input loop is used, release the **TERM** pushbutton.
4. Connect the **OUTPUTS 1** to **5** s-video connectors to up to 5 acceptors² (for example, s-video recorders).
5. Connect the **12V DC** power supply to the unit (not shown in the illustration) and then to the mains electricity. Switch on the power.

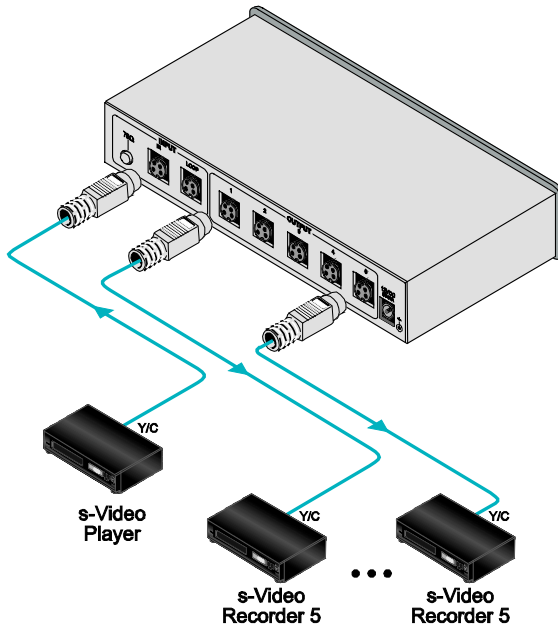

Figure 10: Connecting the VM-50YC 1:5 s-Video Distributor

1 Switch OFF the power on each device before connecting it to your VM-50YC. After connecting, switch on the VM-50YC power and then switch on the power on each device

2 You are not required to connect all the acceptors

6 Technical Specifications

Tables 6 to 10 list technical specifications¹ for the distributors:

Table 6: VM-2N Technical Specifications

INPUT:	1 composite video: DC coupled. 1Vpp/75Ω on a BNC connector; 1 audio: stereo/balanced mono. +4dBu/50kΩ on RCA connectors
OUTPUT:	2 composite video: 1Vpp/75Ω on BNC connectors. 2 audio: stereo/balanced mono, +4dBu/50Ω on RCA connectors
MAX. AUDIO LEVEL (-3dB):	22dBu
VIDEO BANDWIDTH:	Exceeding 400MHz
AUDIO BANDWIDTH:	>100kHz (1dB)
DIFFERENTIAL GAIN:	<0.05%
DIFFERENTIAL PHASE:	0.1Deg
K-FACTOR:	<0.05%
S/N RATIO:	Better than 85dB (audio) 75dB (video)
SDI EFF. RANGE:	Up to 50 meters
AUDIO THD+N:	0.017%
POWER SOURCE:	230V AC/50Hz, (115V AC USA), 4.6VA
DIMENSIONS:	16.5cm x 12cm x 4.5cm (6.5" x 4.7" x 1.8") W, D, H
ACCESSORIES:	Power cord
WEIGHT:	0.620kg (1.3lbs) approx
OPTIONS:	RK-1 19" rack adapter

Table 7: VM-50HN Technical Specifications

INPUT:	1 audio stereo, 1Vpp/50kΩ on a 6.5mm phone connector
OUTPUTS:	5 audio stereo, 500mW/8Ω on 6.5mm phone connectors
AUDIO BANDWIDTH (-3dB):	25kHz
CONTROL:	5 stereo output level controls (front), 1 mono switch (rear)
GAIN RANGE:	-60dB to +10dB
S/N RATIO:	78dB
THD:	0.08% @100mW
POWER SOURCE:	12V DC, 370mA nom, 1A max
DIMENSIONS:	16.5cm x 12cm x 4.5cm (6.5" x 4.72" x 1.77") W, D, H
WEIGHT:	0.68kg (1.5lbs) approx
ACCESSORIES:	12V DC power supply
OPTIONS:	RK-13 19" rack adapter

¹ Specifications are subject to change without notice

Technical Specifications

Table 8: VM-5S Technical Specifications

INPUT:	1 video AC/DC coupled (internal jumper), looping 1Vpp/75 Ω on BNC connectors with rear termination switch; 1 audio stereo/mono balanced, up to 21V/50 k Ω on RCA connectors
OUTPUTS:	5 video, 1 Vpp/75 Ω on BNC connectors; 5 audio stereo/balanced mono, up to 21V/220 Ω on RCA connectors
MAX. VIDEO OUTPUT:	1.7 Vpp
VIDEO BANDWIDTH (-3dB):	340MHz
AUDIO BANDWIDTH (-3dB):	20kHz
DIFF. GAIN:	0.05%
DIFF. PHASE:	0.1Deg
K-FACTOR:	0.05%
VIDEO S/N RATIO:	75dB
AUDIO S/N:	82dB @1V
COUPLING:	DC/AC internally selectable
AUDIO THD:	0.009%
SDI EFFECTIVE RANGE:	Up to 70 meters
POWER SOURCE:	230V AC, 50/60Hz, (115V U.S.A.) 3.5VA
DIMENSIONS:	22cm x 18cm x 4.5cm (8.7" x 7" x 1.8") W, D, H (half 19")
WEIGHT:	1.4kg (3.3lbs) approx
ACCESSORIES:	Power cord
OPTIONS:	RK-1 19" rack adapter

Table 9: VM-50V Technical Specifications

INPUT:	1 video, looping, 1Vpp/75 Ω on BNC connectors with a termination switch
OUTPUTS:	5 video, 1Vpp/75 Ω on BNC connectors
MAX. VIDEO OUTPUT:	2Vpp
VIDEO BANDWIDTH (-3dB):	480MHz
DIFF. GAIN:	0.05%
DIFF. PHASE:	0.12Deg
K-FACTOR:	<0.05%
S/N RATIO:	73dB
CONTROL:	75 Ω termination switch
COUPLING:	AC
POWER SOURCE:	12V DC, 40mA
DIMENSIONS:	16.5cm x 12cm x 4.5cm (6.5" x 4.7" x 2.8") W, D, H
WEIGHT:	0.62kg (1.4lbs) approx
ACCESSORIES:	12V DC power supply, brackets for stacking multiple units
OPTIONS:	RK-1 19" rack adapter

Technical Specifications

Table 10: VM-50YC Technical Specifications

INPUT:	1 s-Video, looping: 1Vpp/75 Ω (Y), 0.3 Vpp/75 Ω (C), on 4pin connectors with a termination switch
OUTPUTS:	5 s-Video: 1Vpp/75 Ω (Y), 0.3 Vpp/75 Ω (C), on 4pin connectors
MAX. VIDEO OUTPUT:	2Vpp (Y)
s-VIDEO BANDWIDTH (-3dB):	285MHz (Y)
DIFF. GAIN:	0.05%
DIFF. PHASE:	0.05Deg
K-FACTOR:	0.05%
S/N RATIO:	80dB
CONTROL:	75 Ω termination switch
COUPLING:	AC
POWER SOURCE:	12V DC, 50mA
DIMENSIONS:	16.5cm x 12cm x 4.5cm (6.5" x 4.7" x 2.8") W, D, H
WEIGHT:	0.58kg (1.3lbs) approx
ACCESSORIES:	12V DC power supply, brackets for stacking multiple units
OPTIONS:	RK-1 19" rack adapter

LIMITED WARRANTY

Kramer Electronics (hereafter *Kramer*) warrants this product free from defects in material and workmanship under the following terms.

HOW LONG IS THE WARRANTY

Labor and parts are warranted for seven years from the date of the first customer purchase.

WHO IS PROTECTED?

Only the first purchase customer may enforce this warranty.

WHAT IS COVERED AND WHAT IS NOT COVERED

Except as below, this warranty covers all defects in material or workmanship in this product. The following are not covered by the warranty:

1. Any product which is not distributed by Kramer, or which is not purchased from an authorized Kramer dealer. If you are uncertain as to whether a dealer is authorized, please contact Kramer at one of the agents listed in the Web site www.kramerelectronics.com.
2. Any product, on which the serial number has been defaced, modified or removed, or on which the WARRANTY VOID IF TAMPERED sticker has been torn, reattached, removed or otherwise interfered with.
3. Damage, deterioration or malfunction resulting from:
 - i) Accident, misuse, abuse, neglect, fire, water, lightning or other acts of nature
 - ii) Product modification, or failure to follow instructions supplied with the product
 - iii) Repair or attempted repair by anyone not authorized by Kramer
 - iv) Any shipment of the product (claims must be presented to the carrier)
 - v) Removal or installation of the product
 - vi) Any other cause, which does not relate to a product defect
 - vii) Cartons, equipment enclosures, cables or accessories used in conjunction with the product

WHAT WE WILL PAY FOR AND WHAT WE WILL NOT PAY FOR

We will pay labor and material expenses for covered items. We will not pay for the following:

1. Removal or installations charges.
2. Costs of initial technical adjustments (set-up), including adjustment of user controls or programming. These costs are the responsibility of the Kramer dealer from whom the product was purchased.
3. Shipping charges.

HOW YOU CAN GET WARRANTY SERVICE

1. To obtain service on you product, you must take or ship it prepaid to any authorized Kramer service center.
2. Whenever warranty service is required, the original dated invoice (or a copy) must be presented as proof of warranty coverage, and should be included in any shipment of the product. Please also include in any mailing a contact name, company, address, and a description of the problem(s).
3. For the name of the nearest Kramer authorized service center, consult your authorized dealer.

LIMITATION OF IMPLIED WARRANTIES

All implied warranties, including warranties of merchantability and fitness for a particular purpose, are limited in duration to the length of this warranty.

EXCLUSION OF DAMAGES

The liability of Kramer for any effective products is limited to the repair or replacement of the product at our option. Kramer shall not be liable for:

1. Damage to other property caused by defects in this product, damages based upon inconvenience, loss of use of the product, loss of time, commercial loss; or:
2. Any other damages, whether incidental, consequential or otherwise. Some countries may not allow limitations on how long an implied warranty lasts and/or do not allow the exclusion or limitation of incidental or consequential damages, so the above limitations and exclusions may not apply to you.

This warranty gives you specific legal rights, and you may also have other rights, which vary from place to place.

NOTE: All products returned to Kramer for service must have prior approval. This may be obtained from your dealer.

This equipment has been tested to determine compliance with the requirements of:

- EN-50081: "Electromagnetic compatibility (EMC); generic emission standard.
Part 1: Residential, commercial and light industry"
- EN-50082: "Electromagnetic compatibility (EMC) generic immunity standard.
Part 1: Residential, commercial and light industry environment".
- CFR-47: FCC* Rules and Regulations:
Part 15: "Radio frequency devices
Subpart B Unintentional radiators"

CAUTION!

- Servicing the machines can only be done by an authorized Kramer technician. Any user who makes changes or modifications to the unit without the expressed approval of the manufacturer will void user authority to operate the equipment.
- Use the supplied DC power supply to feed power to the machine.
- Please use recommended interconnection cables to connect the machine to other components.

* FCC and CE approved using STP cable (for twisted pair products)



For the latest information on our products and a list of Kramer distributors, visit our Web site: www.kramerelectronics.com where updates to this user manual may be found. We welcome your questions, comments and feedback.



Caution

Safety Warning:

Disconnect the unit from the power supply before opening/servicing.



PN: 2900-000535



Rev: 3

Kramer Electronics, Ltd.

Web site: www.kramerelectronics.com

E-mail: info@kramerelect.com

P/N: 2900-000535 REV 3