

# TANNOY®

## CVS INSTALLATION MANUAL

CVS 4 MICRO

Tannoy has a policy of continuous improvement and this specification sheet provides the latest information at the time of printing. All specifications may be subject to further change. Please contact the Tannoy website for the latest information.

REVISION DATE: 26TH August 2008

### CVS

Tannoy United Kingdom	T: 00 44 (0) 1236 420199	E: enquiries@tannoy.com
Tannoy North America	T: 00 1 (519) 745 1158	E: inquiries@tannoyna.com
Tannoy Deutschland	T: 00 49 (180) 1111 881	E: anfragen@tannoy.com
Tannoy France	T: 00 33 (0)1 7036 7473	E: ventes@tannoy.com



tannoy.com

6481 0546



**LISTED**

TEMPLATE HOLE CUTOUT SIZE - Ø180mm [8.39"]

## CONTENTS

---

- 1 | INTRODUCTION
- 2 | UNPACKING
- 3 | SAFETY NOTICES
- 4 | PRODUCT FEATURE IDENTIFICATION
- 5 | ACCESSORIES
- 6 | INSTALLATION GUIDE
  - 6.1 | MECHANICAL INSTALLATION GUIDE FOR SUSPENDED CEILINGS
  - 6.2 | MECHANICAL INSTALLATION GUIDE FOR SHEET-ROCK CEILINGS
  - 6.3 | MECHANICAL INSTALLATION INSTRUCTIONS FOR OPTIONAL PLASTER RING
- 7 | WIRING AND SETTING UP
- 8 | DIMENSIONS
  - 8.1 | CVS 4 Micro DIMENSIONS
- 9 | TECHNICAL SPECIFICATIONS
- 10 | PAINTING
- 11 | WARRANTY
- 12 | DECLARATION OF CONFORMITY

## 1. INTRODUCTION

---

Thank you for purchasing this Tannoy Ceiling loudspeaker. This product range is suited for high-level music and speech reinforcement applications requiring exceptional sonic quality with uncompromised reliability.

## 2. UNPACKING

---

Every Tannoy product and accessory is carefully inspected before packing. After unpacking, please inspect your product to make sure no damage has occurred in transit. In the unlikely event of any damage, would you please notify your dealer immediately and retain your shipping carton, as your dealer may ask you to return the faulty unit to him for inspection.

Each CVS loudspeaker is packed in pairs and provided with the following accessories as standard; C Ring, tile-bridge kit, grille, cut-out template, and paint mask. A plaster (mud) ring is also available as an optional extra.

## 3. SAFETY NOTICES

---

Some regional construction codes require the use of a secondary method of securing loudspeakers in ceiling to provide security of a back up support. A secondary support line should be attached from the safety loop on the rear of the product to a source point on the ceiling. Please consult the relevant construction codes in your region.

When using a power driver to install the product it is essential to use the correct torque level settings to avoid over tightening and damage to the ceiling material or clamps.

Recommended torque setting: 1.5Nm

Tannoy will not be held responsible for any damages caused by the improper installation of these loudspeakers.

### SAFETY NOTE:

*In order to comply with relevant fire safety regulations (i.e. BS 5839:1998), it is required that in the event of fire, that failure of the circuit to which the loudspeaker is connected does not occur before evacuation of the building is complete. Suitable measures include: -*

- a) use of terminal blocks (for connection to primary) with a melting point of not less than 650°C, for example constructed from ceramic materials;*
- c) use of terminal blocks of a lower melting point but protected with thermal insulation;*
- d) use of terminal blocks such that, on melting, an open-circuit or a short-circuit does not occur.*

4. PRODUCT FEATURE IDENTIFICATION:

CVS 4 Micro

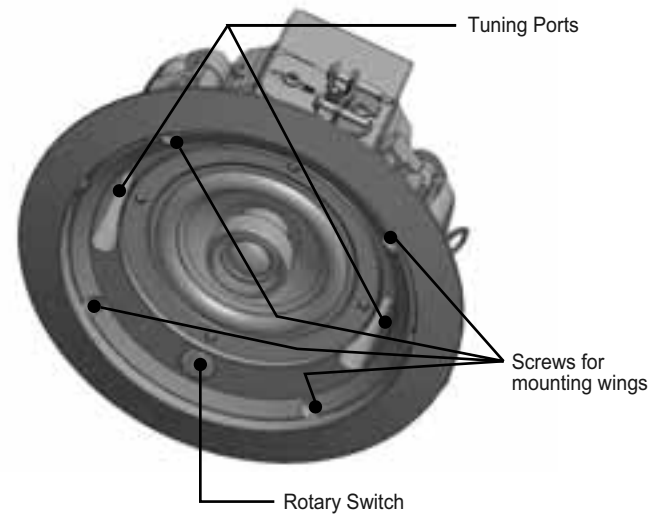
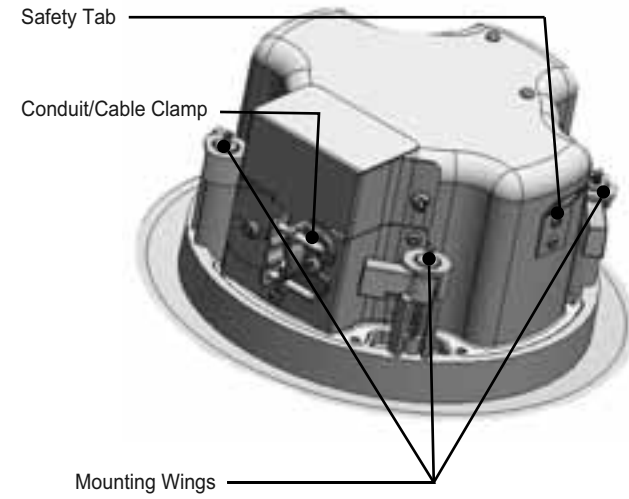

5. ACCESSORIES:

Standard Accessories

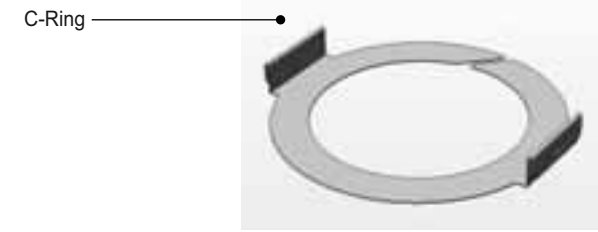

Tile bridge kit  
Note: A tile bridge kit must always be used when installing into suspended ceiling tiles

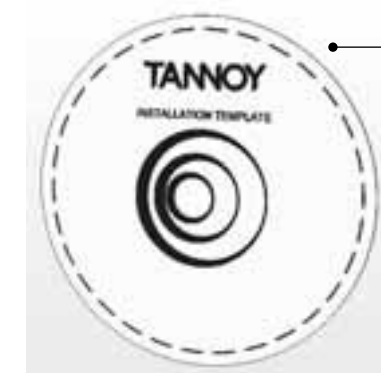
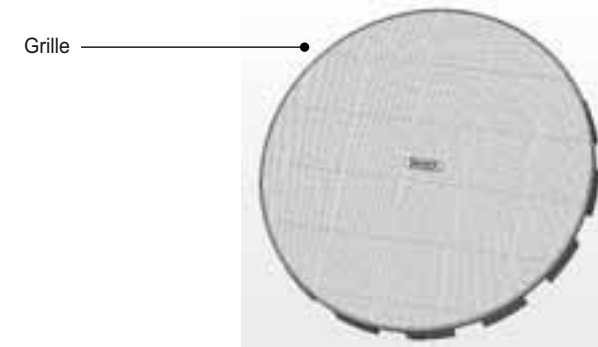

Cut-out template

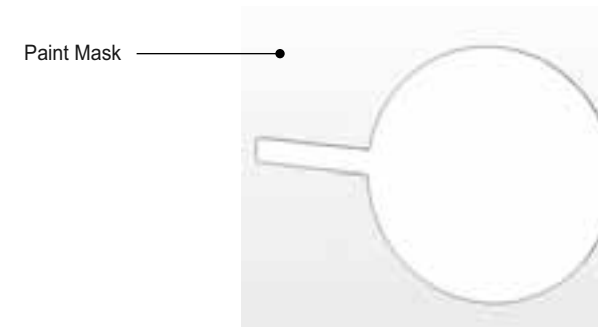

Optional Accessories

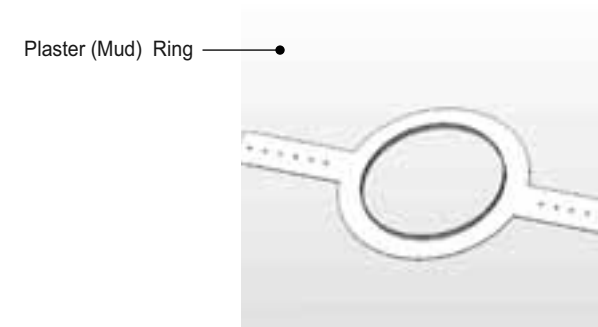

## 6.1 MECHANICAL INSTALLATION GUIDE FOR SUSPENDED CEILINGS

- 1 Remove the ceiling tile from its frame and place it on a flat surface. Mark the cut-out area on the ceiling tile by tracing around the template provided.



- 2 Cut out the hole in the ceiling tile using a circular saw or pad saw.

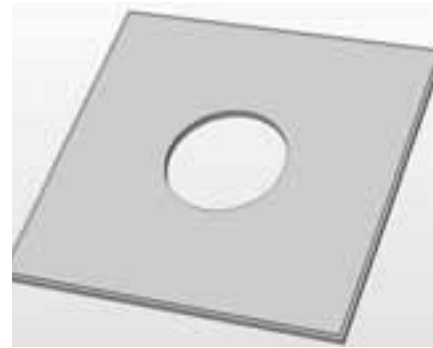

- 3 Place the C-ring and tile-bridge on top of the ceiling panel, aligning the C-ring over the hole, and screw the C-ring to the tile bridge using the fixings provided.

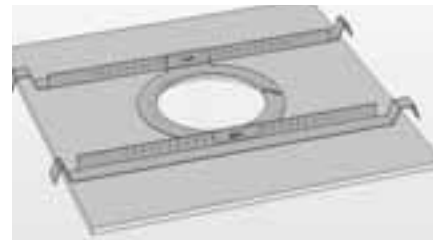

- 4 Slide the speaker assembly through the hole and turn the screws on the front of the speaker to extend the mounting wings. Tighten the screws until a firm grip is achieved.

If using a power driver, Tannoy recommends a torque setting of 1.5Nm.

**DO NOT OVERTIGHTEN!**

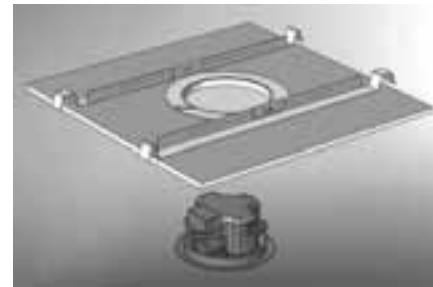

- 5 Slide the tile panel back into the suspended ceiling. The tile bridge ends will catch over the railings, supporting the weight of the speaker.

- 6 Connect a Secondary Support Line to safety tab. Some construction codes require use of this secondary support point, which should connect to a separate secure support point using a suitable support line. Consult construction codes in your region.



Go to section 7 for instructions on wiring and set-up instructions.

## 6.2 MECHANICAL INSTALLATION GUIDE FOR SHEET-ROCK (PLASTER BOARD) CEILINGS

- 1 Mark the cut-out area on the ceiling by tracing around the template provided.



- 2 Cut out the hole in the ceiling using a circular saw or pad saw, then slide the C-ring into the ceiling, aligning it over the cut-out hole).



- 3 Go to section 7 for wiring and set-up instructions then return to point 4 below.

- 4 Slide the speaker assembly through the hole and turn the screws to extend the mounting wings. Tighten the screws until a firm grip is achieved.

If using a power driver, Tannoy recommends a torque setting of 1.5Nm.

**DO NOT OVERTIGHTEN!**

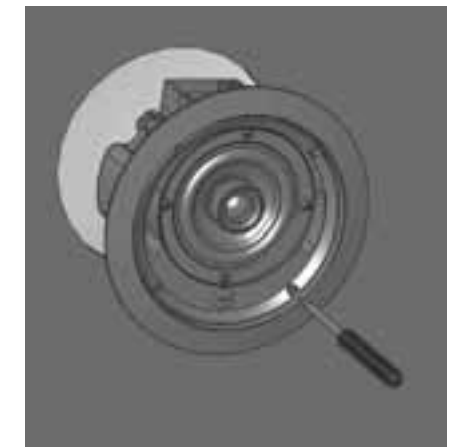

- 5 Connect a Secondary Support Line to safety tab. Some construction codes require use of this secondary support point, which should connect to a separate secure support point using a suitable support line. Consult construction codes in your region.

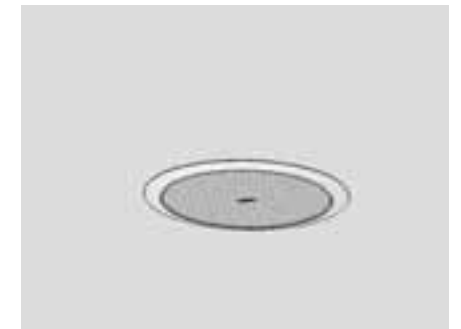

- 6 Insert grille by pushing it onto the speaker.

### 6.3 MECHANICAL INSTALLATION INSTRUCTIONS FOR OPTIONAL PLASTER RING:

An optional plaster (mud) ring bracket is available from Tannoy. This bracket is designed to be pre-installed into newly constructed, non-suspended ceilings.

- 1 | Nail or screw the plaster ring to the joists.

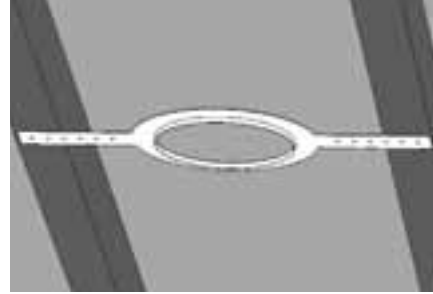

- 2 | Lay the speaker wiring to where the speaker will be fitted and complete the plastering work on the ceiling.

- 3 | Cut out the hole in the ceiling using a circular saw or pad saw.

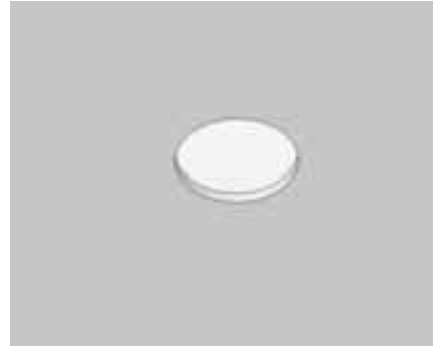

- 4 | Go to section 7 for instructions on wiring then return to point 5 below.

- 5 | Slide the speaker assembly through the hole and turn the screws to extend the mounting wings. Tighten the screws until a firm grip is achieved.

If using a power driver, Tannoy recommends a torque setting of 1.5Nm.

#### DO NOT OVERTIGHTEN!

- 6 | Connect a Secondary Support Line to safety tab. Some construction codes require use of this secondary support point, which should connect to a separate secure support point using a suitable support line. Consult construction codes in your region.



- 7 | Insert grille by pushing it onto the speaker.



### 7. WIRING AND SETTING UP:

- 1 | Open the wiring cover at the back of the speaker can to access the Euro type connector plug and socket.



- 2 | For connection to an amplifier, use pins 1 and 2:

- Pin 1 is positive
- Pin 2 is negative

For connection to additional speakers in a distributed line, pins 3 and 4 are in parallel where:

- Pin 3 is negative
- Pin 4 is positive

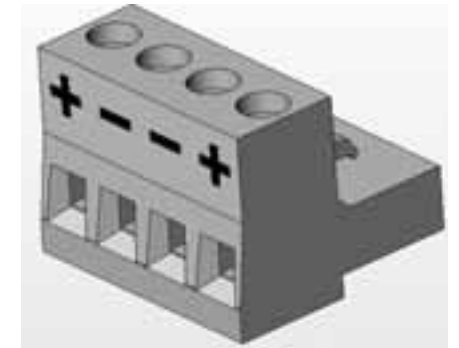

- 3 | Close the wiring cover and tighten both screws on the cable clamp. Use the rotary switch located on the front of the unit to select whether you wish to use the speaker in a low-impedance or distributed-line application.

THE SPEAKER IS SUPPLIED IN LOW IMPEDANCE MODE. NEVER CONNECT THE SPEAKER TO A 70/100 VOLT AMPLIFIER WHILE IT IS SET FOR LOW IMPEDANCE.

- 4 | The CVS 4 Micro is fitted with a 15W transformer. When used in distributed-line systems, the transformer can be tapped at 15W, 7.5W and 3.75W, with an additional 1.9W tapping for 70.7V line systems.

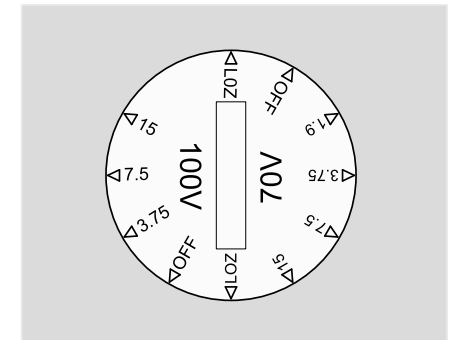

8.1 CVS 4 Micro DIMENSIONS:

CVS 4 Micro TEMPLATE CUTOUT SIZE: 180mm

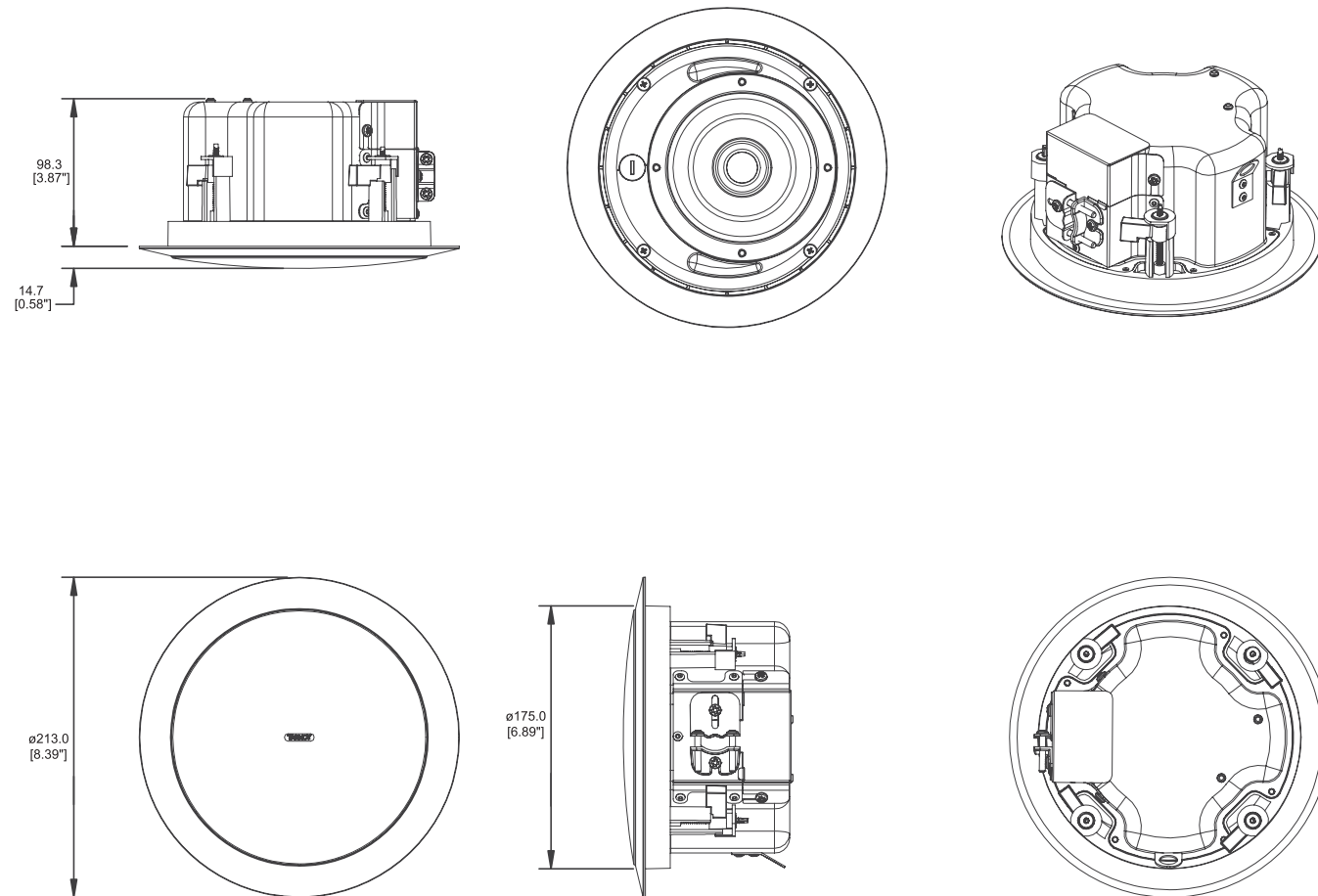

9. SPECIFICATIONS

System

Frequency Response (-3dB) <sup>(1)</sup>	110Hz - 19kHz	
Frequency Range (-10dB) <sup>(1)</sup>	90Hz - 22kHz	
System Sensitivity (1W @1m) <sup>(2)</sup>	87dB (1W = 2.45V for 6 Ohms)	
Nominal Coverage Angle	90 degrees conical	
Coverage Angle (1kHz to 6kHz)	102 degrees	
Directivity Factor (Q)	5.6 averaged 1kHz to 6kHz	
Directivity Index (DI)	7.1 averaged 1kHz to 6kHz	
Rated Maximum SPL <sup>(2)</sup>		
Average	103dB	
Peak	109dB	
Power Handling <sup>(3)</sup>		
Average	40W	
Programme	80W	
Peak	160W	
Rec Amplifier Power	80W @ 6 Ohms	
Nominal Impedance	6 Ohms	
Transformer Taps (via front rotary switch)		
70V	15W / 7.5W / 3.75W / 1.9W / OFF & low impedance operation	
100V	15W / 7.5W / 3.75W / OFF & low impedance operation	
Distortion		
1% Full Power	2nd Harmonic	3rd Harmonic
250Hz	0.231%	0.112%
1kHz	0.229%	0.253%
10kHz	0.163%	0.025%
10% Full Power	2nd Harmonic	3rd Harmonic
250Hz	0.99%	0.169%
1kHz	0.816%	0.323%
10kHz	0.444%	0.027%
Crossover Point	2.7kHz	

Notes:  
 (1) Average over stated bandwidth. Measured in IEC baffle in an Anechoic Chamber  
 (2) Unweighted pink noise input, measured at 1m on axis.  
 (3) Long term power handling capacity as defined in EIA - 426B test.

Transducers

Low Frequency	100mm (4.00") Mineral Loaded
High Frequency	19mm (0.75)

Physical

Enclosure	
Back can	Painted Steel
Baffle	Reflex loaded UL 94V-0 rated ABS
Grille	Steel, with weather resistant coating
Safety Features	Safety ring located at rear of enclosure for load bearing safety bond
Clamping Design	Security toggle Clamp
Back Can Options	
Cable Entry Options	Cable clamp & squeeze connector for conduit up to 22mm
Connectors	Removable locking connector with screw terminals with "loop through" facility.
Safety Agency Rating	UL-1480, UL-2043, CE
Hole Cutout Diameter	180mm
Dimensions	
Bezel diameter	213mm (8.39")
Front of ceiling to rear of back can	98.3mm (3.87")
Front of ceiling to cable entry centre	46.5mm (1.83")
NET Weight	2kg
Included Accessories	C Ring, tile bridge, paint mask, cutout template, grille
Optional Accessories	Plaster (mud) ring

**10. PAINTING**

If desired, the grille and baffle panel may be painted to match the surrounding décor.

Painting the baffle:

- ⊗ Carefully mask off the driver assembly using the paint-mask provided to ensure that the paint does not come into contact with the cone and roll surround.
- ⊗ Apply several thin coats of paint – this will provide a better finish than one overly thick coat.

Painting the grille:

- ⊗ Carefully remove the acoustically transparent foam from the reverse side of the grille.
- ⊗ Paint the grille and then replace the foam - several thin coats of paint will provide a better finish than one overly thick coat.
- ⊗ Re-bond the foam to the grille over the entire area using a light spray-adhesive to avoid audible resonances.

**11. WARRANTY**

No maintenance of the CVS loudspeaker is necessary.

All Tannoy professional loudspeaker products are covered by a 5 year warranty from the date of manufacture subject to the absence of misuse, overload or accidental damage. Claims will not be considered if the serial number has been altered or removed. Work under warranty should only be carried out by a Tannoy Professional dealer or service agent. This warranty in no way affects your statutory rights. For further information please contact your dealer or distributor in your country. If you cannot locate your distributor please contact Customer Services, Tannoy Ltd at the address given below.

Customer Services  
Tannoy Ltd.  
Rosehall Industrial Estate  
Coatbridge  
Strathclyde  
ML5 4TF  
Scotland

Tel: 01236 420199 (National)  
+44 1236 420199 (International)  
Fax: 01236 428230 (National)  
+44 1236 428230 (International)  
E-mail: enquiries@tannoy.com

**DO NOT SHIP ANY PRODUCT TO TANNOY WITHOUT PREVIOUS AUTHORISATION**

Our policy commits us to incorporating improvements to our products through continuous research and development. Please confirm current specifications for critical applications with your supplier.

**12. DECLARATION OF CONFORMITY:**

The following apparatus is/are manufactured in China for Tannoy Ltd of Rosehall Industrial estate, Coatbridge, Scotland, ML5 4TF and conform(s) to the protection requirements of the European Electromagnetic Compatibility Standards and Directives relevant to Domestic Electrical Equipment. The apparatus is designed and constructed such that electromagnetic disturbances generated do not exceed levels allowing radio and telecommunications equipment and other apparatus to operate as intended, and, the apparatus has an adequate level of intrinsic immunity to electromagnetic disturbance to enable operation as specified and intended. This equipment conforms to the requirements of the EMC Directive 89/336/EEC, amended by 92/31/EEC and the requirements of the Low Voltage Directive 73/23/EEC, amended by 93/68/EEC.

Details of the Apparatus:

Tannoy Contractor Loudspeaker

Model Numbers:

CVS 4 Micro

Applicable Standards:

EN55103-1 1996 Emission  
EN55103-2 1996 Immunity

Electrical Safety EN 60065: 2002

Signed:

Position: Director of Engineering

Tannoy Ltd.

Date: 06/06/2008

For Tannoy Ltd