

*Concentric™ Driver*

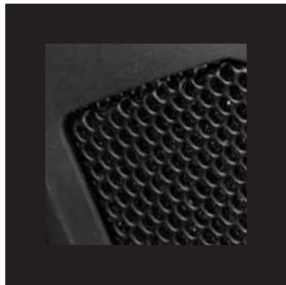
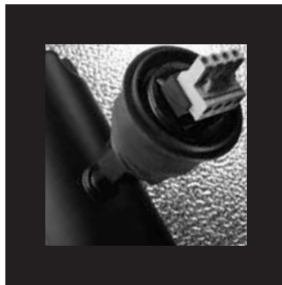
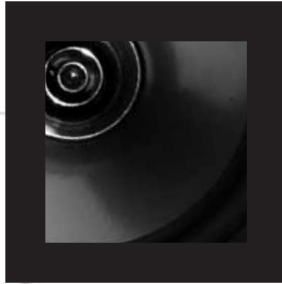

*Additional Custom Colours  
trim available on Request.  
at additional cost*

# THE Di | RANGE

USER MANUAL

Di5, Di5t,  
Di5 DC & Di5 DCt  
Di6, Di6t,  
Di6 DC & Di6 DCt  
Di8 DC & Di8 DCt

**TANNOY®**

# Contents

- 3 INTRODUCTION**
- 3 SAFETY INSTRUCTIONS**
- 4 PRODUCT IDENTIFICATION**
- 5 STANDARD AND OPTIONAL ACCESSORIES**
- 6-9 INSTALLATION GUIDELINES**
  - 6 Installation using supplied yoke bracket
  - 7 Installation using optional K-Ball™ bracket
  - 8 Installation using supplied yoke bracket with optional pole-mount adaptor
  - 9 Installation using optional K-Ball™ bracket with optional pole-mount adaptor
- 10 PRODUCT DIMENSIONS**
- 11 HARDWARE DIMENSIONS**
- 12-13 TECHNICAL SPECIFICATIONS**
  - 12 Di ICT specifications
  - 13 Di Dual Concentric™ specifications
- 14 WARRANTY STATEMENT**
- 15 DECLARATION OF CONFORMITY**

# Introduction

Designed for a wide variety of sound reinforcement applications the Tannoy Di is an ultra compact loudspeaker system capable of delivering high sound pressure levels with extremely low distortion, resulting in outstanding clarity, definition and detail. A truly universal solution, the Di offers outstanding durability and resistance to scuffs and knocks. Able to deliver consistent performance under a wide range of adverse conditions the Di is suited to applications indoors or out, whether it be a theme bar or theme park. Available in black or white the Di will effectively blend into most backgrounds. Utilisation of the point source loudspeaker allows the Di to be mounted on a wall or ceiling in either horizontal or vertical orientations without affecting its performance. A range of hardware options ensures simple and effective installation. Also available with built in line transformer.

For applications requiring extended low frequency enhancement, a range of Tannoy sub-bass systems are available and can be used in conjunction with the Di.

# Safety Instructions

1. Read these instructions.
2. Keep these instructions.
3. Heed all warnings.
4. Follow all instructions.
5. The user is responsible for fixing the hardware to the surface to ensure safe operation. The fixings must support the weight of the product – please consult the manual's specification page for the appropriate weights. Please consult the relevant construction codes in your region for further information on suitable hardware fixing methods.
6. Some regional construction codes require the use of a secondary method of securing loudspeakers to surfaces to provide security of a back-up support. A secondary support line should be attached from the safety loop on the rear of the product to a source point on the wall. Please consult the relevant construction codes in your region.
7. Tannoy will not be held accountable for any damage caused by incorrect installation.

# Product Identification

**GRILLE TRIM**

Lift the grille trim back using the tab to access the transformer tapping switch on transformer models.

**YOKE TRIM**

Remove the yoke trims on the top and bottom panels to access the yoke bracket fixing point

GRILLE



**INPUT CONNECTOR**

Remove the rubber grommet to access the connector. The rubber grommet ensures the rear of the product is kept water-tight

SAFETY TAB



# Standard Accessories

**GRILLE**



**GRILLE TRIM**

**YOKE BRACKET**  
(SUPPLIED WITH  
FIXINGS)



# Optional Accessories



**K-BALL™ BRACKET**

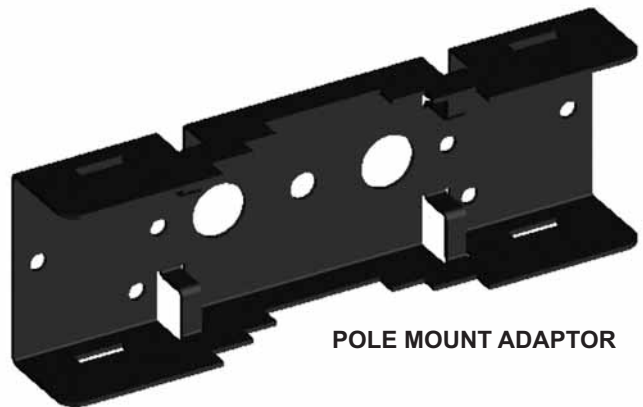

**POLE MOUNT ADAPTOR**

# Installation Guidelines

## USING SUPPLIED YOKE BRACKET

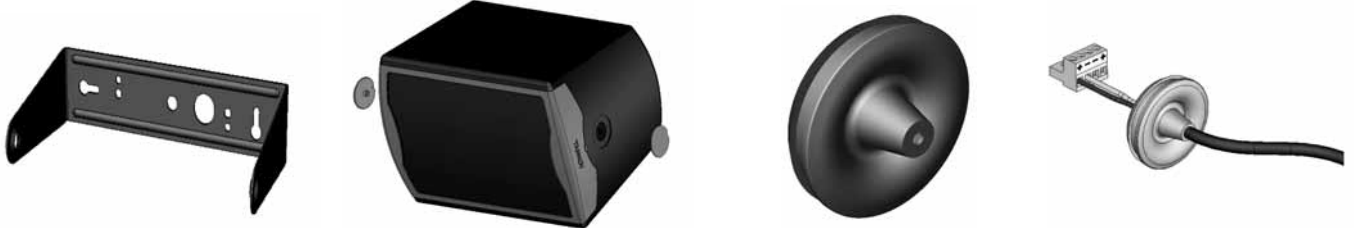

**1.** Fix the yoke bracket to the surface using a suitable fixing method.

**2.** Remove the yoke trims from the product to access the bracket fixing points.

**3.** Remove the rubber grommet from the rear of the speaker. Inclusion of the rubber grommet is only required if installing the product outdoors.

**4.** Feed the speaker cable through the rubber grommet then connect the euro-type plug to the wires, observing the correct polarity.

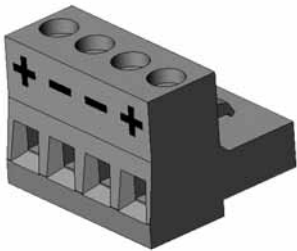

**5.** For connection to the loudspeaker, use pins 1 (+) and 2 (-).

Pins 3 (-) and 4 (+) are in parallel for connection to additional speakers in a distributed line.



**6.** Offer the speaker up to the bracket and attach it using a 5mm allen key and supplied fixings.



**7.** Connect the euro plug then replace the rubber grommet to ensure the speaker is watertight.



**8.** Connect a secondary support line to the safety tab at the rear of the cabinet.

### TRANSFORMER MODELS ONLY



**9.** Lift the grille trim using the tab to access the rotary transformer tapping switch. The rotary switch is found on the top of the Di5 models, and on the bottom of the Di6 and Di8 models.

### TRANSFORMER MODELS ONLY

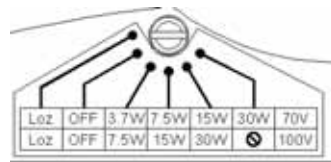

**10.** The Di5t and Di5 DCt models are fitted with 30W transformers. THE SPEAKER IS SUPPLIED IN LOW IMPEDANCE MODE. NEVER CONNECT THE SPEAKER TO A 70/100 VOLT AMPLIFIER WHILE IT IS SET FOR LOW IMPEDANCE.

### TRANSFORMER MODELS ONLY

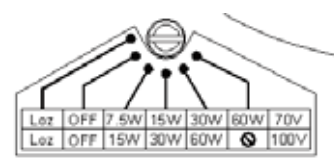

**11.** The Di6t, Di6 DCt, & Di8 DCt models are fitted with 60W transformers. THE SPEAKER IS SUPPLIED IN LOW IMPEDANCE MODE. NEVER CONNECT THE SPEAKER TO A 70/100 VOLT AMPLIFIER WHILE IT IS SET FOR LOW IMPEDANCE.

# Installation Guidelines

## USING OPTIONAL K-BALL™ BRACKET

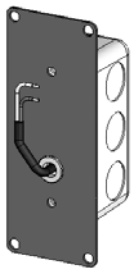

1. If attaching the K-Ball™ bracket to a conduit junction box (J-box), pass the speaker wire through the bracket adaptor plate then attach the adaptor plate to the conduit junction box using the fixings provided.

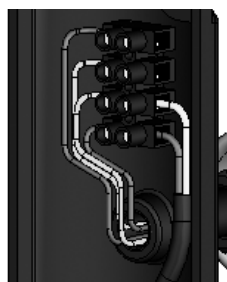

2. Connect the speaker wires to the connector block in the bracket. For connection to an amplifier use pins 1 (+) and 2 (-) Pins 3 (-) and 4 (+) are in parallel for connection to additional speakers in a distributed line.



3. If a conduit junction box has been used, offer the bracket up to the adaptor plate, with the foam gasket\*\* squeezed in between. Attach the bracket to the surface using a suitable fixing method\*.



4. If you are attaching the bracket directly to a surface, offer the bracket up to the surface with the foam gasket\*\* squeezed in between. Attach the bracket to the surface using a suitable fixing method\*.



5. Offer the speaker up to the K-Ball™ Bracket. Push the speaker onto the bracket to engage the euro plug.

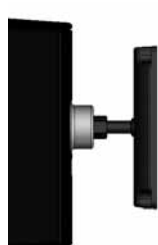

6. Fit the rubber grommet and finger-tighten the bracket bolt while supporting the speaker. If the connector has engaged properly the speaker will lock onto the bracket



7. Swivel the speaker into position then use a 19mm wrench to give another half turn to ensure the speaker is locked in position.



8. Connect a secondary support line to the safety tab at the rear of the cabinet.

### TRANSFORMER MODELS ONLY



9. Lift the grille trim using the tab to access the rotary transformer tapping switch. The rotary switch is found on the top of the Di5 models, and on the bottom of the Di6 and Di8 models.

### TRANSFORMER MODELS ONLY

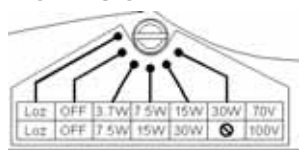

10. The Di5t and Di5 DCt models are fitted with 30W transformers. THE SPEAKER IS SUPPLIED IN LOW IMPEDANCE MODE. NEVER CONNECT THE SPEAKER TO A 70/100 VOLT AMPLIFIER WHILE IT IS SET FOR LOW IMPEDANCE.

### TRANSFORMER MODELS ONLY

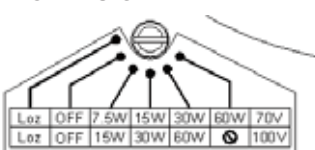

11. The Di6t, Di6 DCt, & Di8 DCt models are fitted with 60W transformers. THE SPEAKER IS SUPPLIED IN LOW IMPEDANCE MODE. NEVER CONNECT THE SPEAKER TO A 70/100 VOLT AMPLIFIER WHILE IT IS SET FOR LOW IMPEDANCE.

### NOTE

- \* See safety notices on page 3
- \*\* The foam gasket & rubber grommet is intended to provide a water tight seal. Inclusion of the foam gasket & grommet is only a requirement if installing outdoors.

# Installation Guidelines

## USING OPTIONAL POLE MOUNT ADAPTOR WITH SUPPLIED YOKE BRACKET

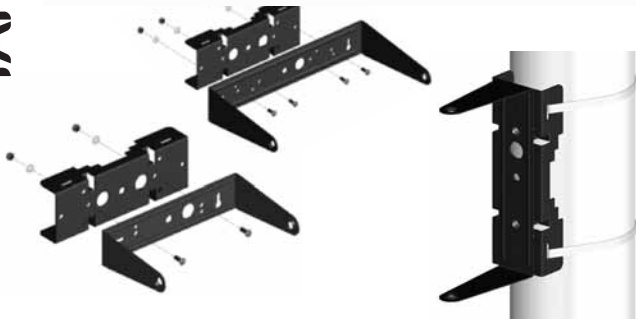

1. Use the supplied fixings to fix the yoke bracket to the pole bracket adaptor.

Note that the Di5 models require 2 fixing screws whereas the Di6 and Di8 models require 4 fixing screws.



2. Fix the pole mount bracket adaptor to the pole using the strapping provided. The bracket can be mounted in portrait or landscape orientations.



3. Remove the yoke trims from the product to access the bracket fixing points.



4. Remove the rubber grommet from the rear of the speaker. Inclusion of the rubber grommet is only required if installing the product outdoors.



5. Feed the speaker cable through the rubber grommet then connect the euro-type plug to the wires, observing the correct polarity.

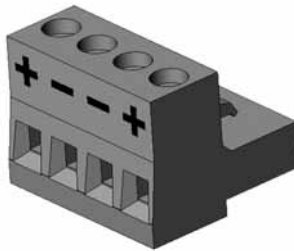

6. For connection to the loudspeaker, use pins 1 (+) and 2 (-)

Pins 3 (-) and 4 (+) are in parallel for connection to additional speakers in a distributed line.

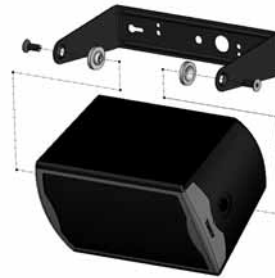

7. Offer the speaker up to the bracket and attach it using a 5mm allen key and supplied fixings.



8. Connect the euro plug then replace the rubber grommet to ensure the speaker is watertight.



9. Connect a secondary support line to the safety tab at the rear of the cabinet.



### TRANSFORMER MODELS ONLY



10. Lift the grille trim using the tab to access the rotary transformer tapping switch. The rotary switch is found on the top of the Di5 models, and on the bottom of the Di6 and Di8 models.



### TRANSFORMER MODELS ONLY

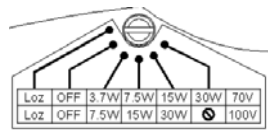

11. The Di5t and Di5 DCt models are fitted with 30W transformers. THE SPEAKER IS SUPPLIED IN LOW IMPEDANCE MODE. NEVER CONNECT THE SPEAKER TO A 70/100 VOLT AMPLIFIER WHILE IT IS SET FOR LOW IMPEDANCE.



### TRANSFORMER MODELS ONLY

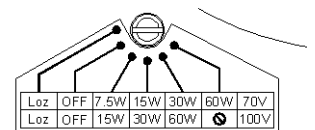

12. The Di6t, Di6 DCt, & Di8 DCt models are fitted with 60W transformers. THE SPEAKER IS SUPPLIED IN LOW IMPEDANCE MODE. NEVER CONNECT THE SPEAKER TO A 70/100 VOLT AMPLIFIER WHILE IT IS SET FOR LOW IMPEDANCE.



# Installation Guidelines

## USING POLE MOUNT ADAPTOR WITH OPTIONAL K-BALL™ BRACKET

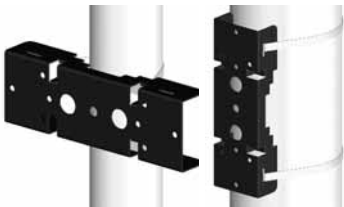

1. Pass the speaker wire through the pole-mount adaptor plate then fix the pole mount bracket adaptor to the pole using the strapping provided. The bracket can be mounted portrait or landscape orientations.

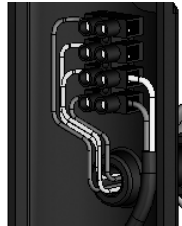

2. Connect the speaker wires to the connector block in the rear of the K-Ball™ bracket. For connection to an amplifier use pins 1 (+) and 2 (-). Pins 3 (-) and 4 (+) are in parallel for connection to additional speakers in a distributed line.

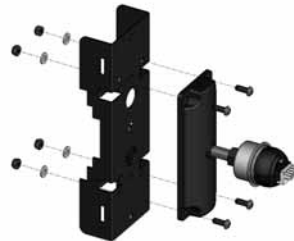

3. Offer the K-Ball™ bracket up to the adaptor plate, with the foam gasket\*\* squeezed in between. Use the supplied fixings to fix the K-Ball™ bracket to the pole bracket adaptor.

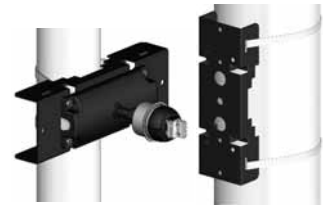

4. Fix the pole mount bracket adaptor to the pole using the strapping provided. The bracket can be mounted in portrait or landscape orientations.



5. Remove the rubber grommet from the rear of the speaker then offer the speaker up to the K-Ball™ Bracket.



6. Finger-tighten the bracket bolt to extend the bracket out to connect with the euro plug socket. Position speaker then use a 19mm wrench to give another half turn to ensure the speaker is locked in position.



7. Connect a secondary support line to the safety tab at the rear of the cabinet.

### TRANSFORMER MODELS ONLY



8. Lift the grille trim using the tab to access the rotary transformer tapping switch. The rotary switch is found on the top of the Di5 models, and on the bottom of the Di6 and Di8 models.

### TRANSFORMER MODELS ONLY

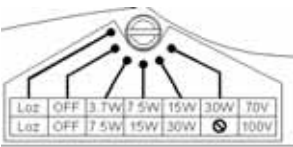

9. The Di5t and Di5 DCt models are fitted with 30W transformers. THE SPEAKER IS SUPPLIED IN LOW IMPEDANCE MODE. NEVER CONNECT THE SPEAKER TO A 70/100 VOLT AMPLIFIER WHILE IT IS SET FOR LOW IMPEDANCE.

### TRANSFORMER MODELS ONLY

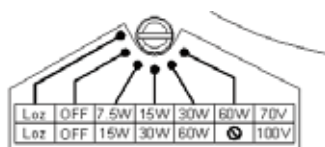

10. The Di6t, Di6 DCt, & Di8 DCt models are fitted with 60W transformers. THE SPEAKER IS SUPPLIED IN LOW IMPEDANCE MODE. NEVER CONNECT THE SPEAKER TO A 70/100 VOLT AMPLIFIER WHILE IT IS SET FOR LOW IMPEDANCE.

### NOTE

\*\* The foam gasket & rubber grommet is intended to provide a water tight seal. Inclusion of the foam gasket & grommet is only a requirement if installing outdoors.

# Product Dimensions Di5

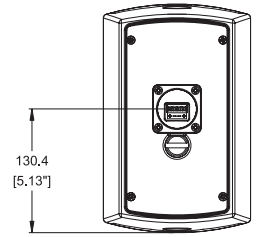
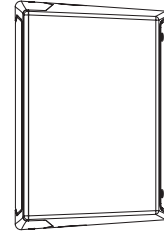
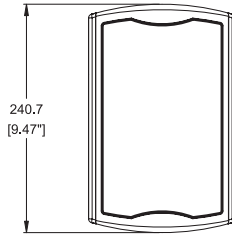
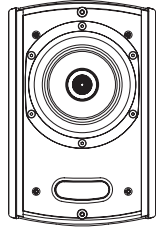
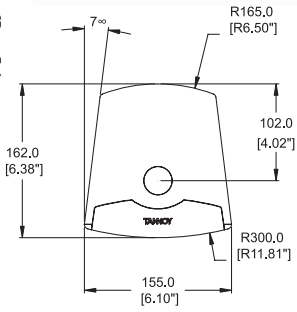

# Product Dimensions Di6

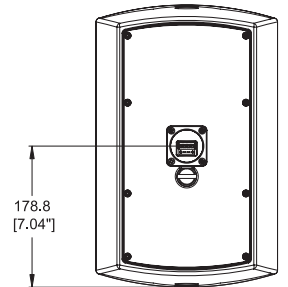
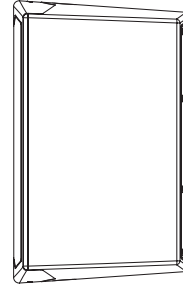
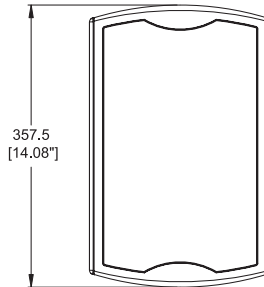
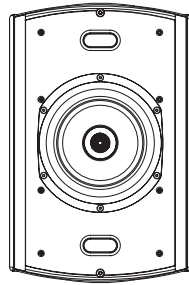
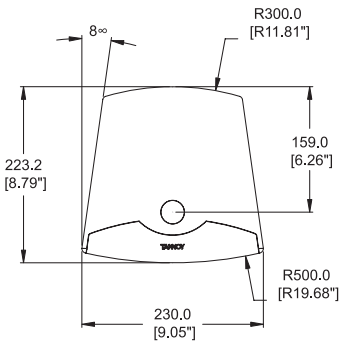

# Product Dimensions Di8

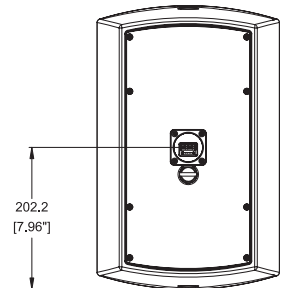
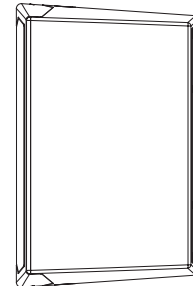
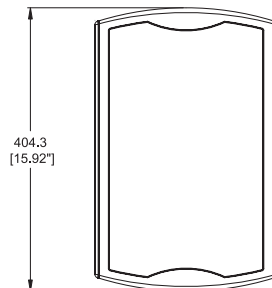
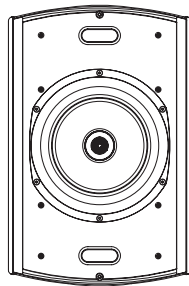
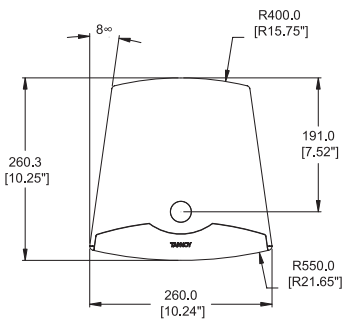

# Hardware Dimensions 5" YOKE BRACKET

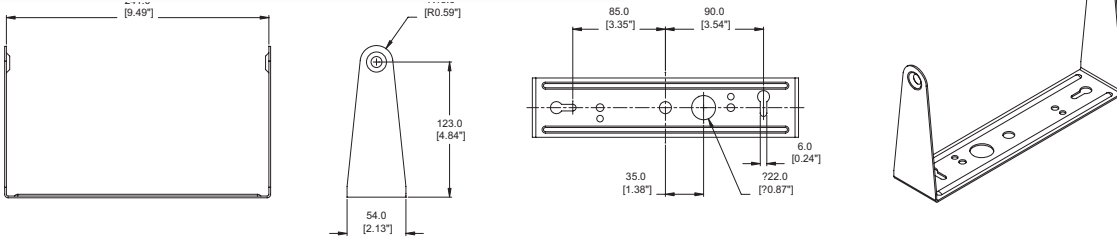

# Hardware Dimensions 6" YOKE BRACKET

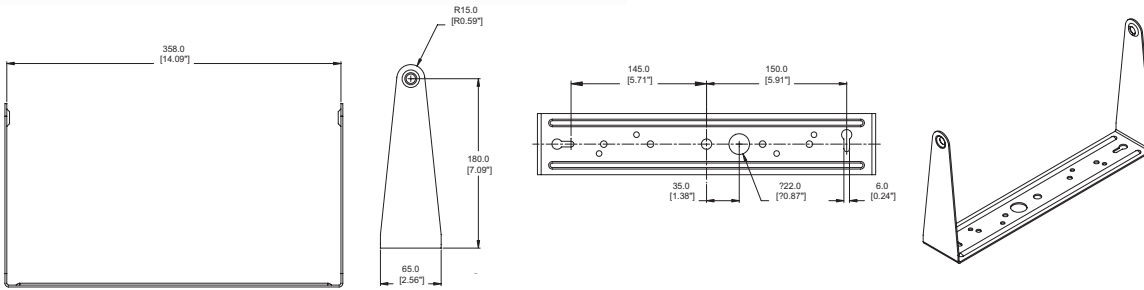

# Hardware Dimensions 8" YOKE BRACKET

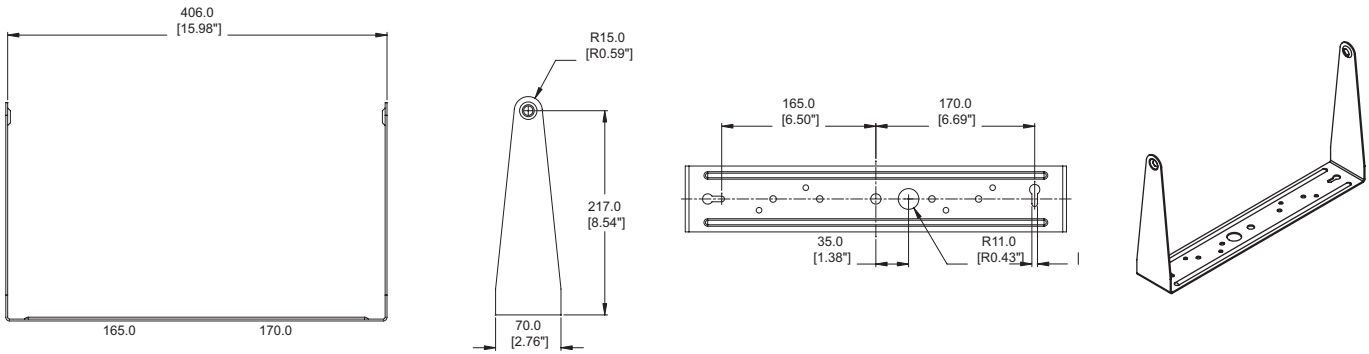

# Hardware Dimensions K-BALL™ BRACKET

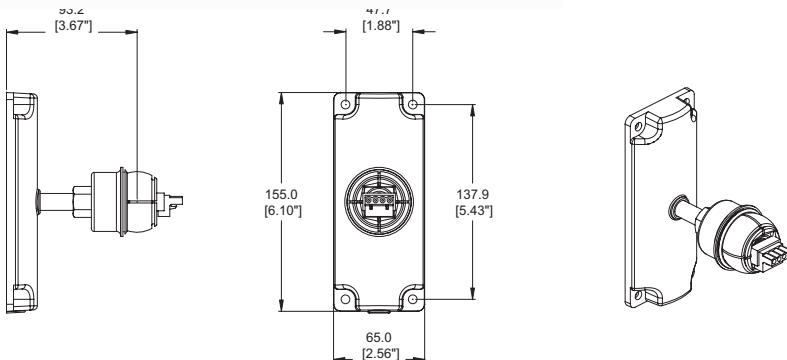

# Specifications. ICT™ MODELS

		Di5	Di6
<b>SYSTEM</b>			
<b>Frequency Response (-3dB) <sup>(1)</sup></b>		90Hz - 25kHz	75Hz - 22kHz
<b>Frequency Range (-10dB) <sup>(1)</sup></b>		80Hz - 30kHz	55Hz - 24kHz
<b>System Sensitivity (1W @1m) <sup>(2)</sup></b> 1W = 2.45V for 6 Ohms		88dB	90dB
<b>Dispersion</b> Degrees conical -6dB		90	90
<b>Low Frequency Driver</b> Mineral loaded polypropylene		1x 110mm (4.50")	1x 165mm (6.50")
<b>High Frequency Driver</b>		ICT™	ICT™
<b>Crossover</b> Inductively Coupled ICT™		7kHz	7kHz
<b>Directivity Factor (Q)</b>	1kHz to 10kHz	5.3 averaged	10.5 averaged
<b>Directivity Index (DI)</b>	1kHz to 10kHz	6.6 averaged	8.4 averaged
<b>Rated Maximum SPL <sup>(2)</sup></b>	Average	105dB	107dB
	Peak	111dB	113dB
<b>Power Handling</b>	Average	50W	60W
	Programme	100W	120W
	Peak	200W	240W
<b>Recommended Amplifier Power</b>		100W @ 6 Ohms	120W @ 6 Ohms
<b>Nominal Impedance</b>		6 Ohms	6 Ohms
<b>Distortion 10% Full Power</b>	(5.5V) 2nd Harmonic		(6.0V) 2nd Harmonic
	3rd Harmonic		3rd Harmonic
	250Hz	2.00% 0.26%	1.86% 0.12%
1kHz	0.53% 0.19%	1.17% 0.54%	
10kHz	2.50% 0.35%	1.10% 0.04%	
<b>Distortion 1% Full Power</b>	(1.73V) 2nd Harmonic		(1.9V) 2nd Harmonic
	3rd Harmonic		3rd Harmonic
	250Hz	0.65% 0.09%	0.70% 0.14%
1kHz	0.144% 0.11%	0.45% 0.39%	
10kHz	0.52% 0.298%	0.25% 0.065%	

**CONSTRUCTION**

<b>Enclosure</b>	Weather resistant high impact polystyrene (HIPS), IP64 to EN60529 (IEC529)
<b>Grille</b>	Steel, with weather resistant coating
<b>Finish</b>	Textured black or white paint with matching rubber trims Factory fitted custom trim colours available to special order
<b>Connectors</b>	Removable locking Euroblock type connector with screw terminals and "loop through" facility
<b>Fittings</b>	1 x socket for K-Ball™ bracket and 2 x M8 yoke bracket inserts
<b>Supplied Accessory</b>	Yoke bracket
<b>Dimensions</b>	240.7 x 155.0 x 162.0mm 9.47 x 6.10 x 6.38"
<b>Weight</b>	2.2kg (4.85lbs) 3.7kg (8.15lbs)

**TRANSFORMER VERSIONS**

Specifications as above except:

		Di5t	Di6t
<b>Transformer Taps</b>	70V	30W / 15W / 7.5W / 3.75W / OFF & Low Impedance operation	60W / 30W / 15W / 7.5W / OFF & Low Impedance operation
	100V	30W / 15W / 7.5W / OFF & Low Impedance operation	60W / 30W / 15W / OFF & Low Impedance operation
<b>* Rated Maximum SPL <sup>(2)</sup></b>	Average	103dB (using 30W transformer tap)	107dB (using 60W transformer tap)
<b>Weight</b>		2.7kg (5.94lbs)	5.0kg (11.02lbs)

\* See Passive models above for max SPL figures on low impedance settings.

**Notes:**

(1) Average over stated bandwidth. Measured at 1 metre on axis in an anechoic chamber

(2) Unweighted pink noise input, measured at 1 metre in an anechoic chamber

A full range of measurements, performance data, and Ease™ Data can be downloaded from [www.tannoy.com](http://www.tannoy.com)

Tannoy operates a policy of continuous research and development. The introduction of new materials or manufacturing methods will always equal or exceed the published specifications, which Tannoy reserves the right to alter without prior notice.

		Di5 DC	Di6 DC	Di8 DC		
<b>SYSTEM</b>						
<b>Frequency Response (-3dB) <sup>(1)</sup></b>		90Hz - 50kHz	75Hz - 30kHz	65Hz - 30kHz		
<b>Frequency Range (-10dB) <sup>(1)</sup></b>		80Hz - 54kHz	55Hz - 35kHz	53Hz - 35kHz		
<b>System Sensitivity (1W @1m) <sup>(2)</sup></b> 1W = 2.83V for 8 Ohms		89dB	91dB			
<b>Dispersion</b> Degrees conical -6dB		90	90	90		
<b>Low Frequency Driver</b> Dual Concentric™ constant directivity driver with a resin treated multi fibre paper pulp cone		1x 110mm (4.50")	1x 165mm (6.50")	1x 200mm (8.00")		
<b>High Frequency Driver</b> titanium dome with neodymium magnet system		19mm (0.75")	25mm (1.00")	25mm (1.00")		
<b>Crossover</b>		2kHz - 2nd order LF, 2nd order HF with Dynamic HF protection	1.6kHz - 2nd order LF, 2nd order HF with Dynamic HF protection	1.5kHz - 2nd order LF, 2nd order HF with Dynamic HF protection		
<b>Directivity Factor (Q)</b>	1kHz to 10kHz	5.3 averaged	5.6 averaged	5.5 averaged		
<b>Directivity Index (DI)</b>	1kHz to 10kHz	6.6 averaged	7.0 averaged	7.0 averaged		
<b>Rated Maximum SPL <sup>(2)</sup></b>	Average	106dB	109dB	111dB		
	Peak	112dB	115dB	117dB		
<b>Power Handling</b>	Average	60W	90W	90W		
	Programme	120W	180W	180W		
	Peak	240W	360W	360W		
<b>Recommended Amplifier Power</b>		120W @ 8 Ohms	180W @ 8 Ohms	180W @ 8 Ohms		
<b>Nominal Impedance</b>		8 Ohms	8 Ohms	8 Ohms		
<b>Distortion 10% Full Power</b>	(6.9V) 2nd Harmonic		(8.0V) 2nd Harmonic	(8.5V) 2nd Harmonic		
	3rd Harmonic		3rd Harmonic	3rd Harmonic		
	250Hz	4.00%	0.20%	1.00%	0.32%	1.55%
1kHz	0.76%	0.60%	0.18%	0.32%	0.41%	0.63%
10kHz	0.65%	0.15%	1.00%	0.18%	1.20%	0.65%
<b>Distortion 1% Full Power</b>	(2.2V) 2nd Harmonic		(2.5V) 2nd Harmonic	(2.7V) 2nd Harmonic		
	3rd Harmonic		3rd Harmonic	3rd Harmonic		
	250Hz	2.00%	0.15%	0.25%	0.25%	0.43%
1kHz	0.009%	0.124%	0.06%	0.18%	0.07%	0.47%
10kHz	0.32%	0.17%	0.45%	0.14%	0.55%	0.13%
<b>CONSTRUCTION</b>						
<b>Enclosure</b>		Weather resistant high impact polystyrene (HIPS), IP64 to EN60529 (IEC529)				
<b>Grille</b>		Steel, with weather resistant coating				
<b>Finish</b>		Textured black or white paint with matching rubber trims				
		Factory fitted custom trim colours available to special order				
<b>Connectors</b>		Removable locking Euroblock type connector with screw terminals and "loop through" facility				
<b>Fittings</b>		1 x socket for K-Ball™ bracket and 2 x M8 yoke bracket inserts				
<b>Supplied Accessory</b>		Yoke bracket				
<b>Dimensions</b>		240.7 x 155.0 x 162.0mm	357.5 x 230.0 x 223.2mm	404.3 x 260.0 x 260.3mm		
		9.47 x 6.10 x 6.38"	14.08 x 9.05 x 8.79"	15.92 x 10.24 x 10.25"		
<b>Weight</b>		2.2kg (4.85lbs)	5.0kg (11.02lbs)	6.0kg (13.23lbs)		

		Di5 DCt	Di6 DCt	Di8 DCt
<b>TRANSFORMER VERSIONS</b> Specifications as above except:				
<b>Transformer Taps</b> Rotary switch mounted under trim	70V	30W / 15W / 7.5W / 3.75W / OFF & Low Impedance operation	60W / 30W / 15W / 7.5W / OFF & Low Impedance operation	60W / 30W / 15W / 7.5W / OFF & Low Impedance operation
	100V	30W / 15W / 7.5W / OFF & Low Impedance operation	60W / 30W / 15W / 7.5W / OFF Low Impedance operation	60W / 30W / 15W / OFF & Low Impedance operation
* <b>Rated Maximum SPL <sup>(2)</sup></b>	Average	106dB (103dB - 30W transformer tap)	109dB (107dB - 60W transformer tap)	111dB (109dB - 60W transformer tap)
<b>Weight</b>		2.7kg (5.95lbs)	5.5kg (12.12lbs)	7.0kg (15.87lbs)

\* See Passive models above for max SPL figures on low impedance settings.

**Notes:**

(1) Average over stated bandwidth. Measured at 1 metre on axis in an anechoic chamber

(2) Unweighted pink noise input, measured at 1 metre in an anechoic chamber

A full range of measurements, performance data, and Ease™ Data can be downloaded from [www.tannoy.com](http://www.tannoy.com)

Tannoy operates a policy of continuous research and development. The introduction of new materials or manufacturing methods will always equal or exceed the published specifications, which Tannoy reserves the right to alter without prior notice.

**No maintenance of the Di loudspeaker is necessary.**

All of our products have been produced and tested with care and precision to give first-class service.

All passive components are guaranteed for a period of five years from the date of purchase from an authorised Tannoy dealer subject to the absence or evidence of misuse, overload, or accidental damage.

All active and electronic components are guaranteed for a period of one year from the date of purchase from an authorised Tannoy dealer subject to the absence of, or evidence of, misuse, overload or accidental damage.

If at any time during this warranty period the equipment proves to be defective for any reason other than accident, misuse, neglect, unauthorised modification or fair wear and tear, we will repair any such manufacturing defect or, at our option, replace it without charge for labour, parts or return carriage.

If you suspect a problem with a Tannoy product then, in the first instance, discuss it with your Tannoy dealer. If you require further assistance then we ask that you deal directly with your local Tannoy distributor. If you cannot locate your distributor please contact Customer Services, Tannoy Ltd at the address given below.

Customer Services, Tannoy Ltd., Rosehall Industrial Estate, Coatbridge, Strathclyde ML5 4TF, Scotland

Telephone: 01236 420199 (National)  
+44 1236 420199 (International)  
Fax: 01236 428230 (National)  
+44 1236 428230 (International)  
E-mail: enquiries@tannoy.com

**DO NOT SHIP ANY PRODUCT TO TANNOY WITHOUT PREVIOUS AUTHORISATION**

Our policy commits us to incorporating improvements to our products through continuous research and development. Please confirm current specifications for critical applications with your supplier.

# Declaration of Conformity

The following apparatus is manufactured in China for Tannoy Ltd of Rosehall Industrial Estate, Coatbridge, Scotland, ML5 4TF and conform(s) to the protection requirements of the European Electromagnetic Compatibility Standards and Directives relevant to Domestic Electrical Equipment. The apparatus is designed and constructed such that electromagnetic disturbances generated do not exceed levels allowing radio and telecommunications equipment and other apparatus to operate as intended, and, the apparatus has an adequate level of intrinsic immunity to electromagnetic disturbance to enable operation as specified and intended.

**Details of the Apparatus:**

Tannoy Contractor Loudspeaker  
Model Number: Di

**Associated Technical File:**

EMCi6

**Applicable Standards:**

EN 50081-1 Emission  
EN 50082-1 Immunity



**Signed:**

**Position:**

**Date:**

Director of Engineering (Professional)  
11th Dec. 06

centric™ Driver

Optional Custom Coloured  
available on Request.  
Additional Cost

Tannoy United Kingdom	T: 00 44 (0) 1236 420199	E: enquiries@tannoy.com
Tannoy North America	T: 00 1 (519) 745 1158	E: inquiries@tannoyna.com
Tannoy Deutschland	T: 00 49 (180) 1111 881	E: info@tannoy.com
Tannoy France	T: 00 33 (0)1 7036 7473	E: ventes@tannoy.com

Tannoy adopts a policy of continuous improvement and product specification is subject to change.

tannoy.com